

Garnet in blueschist-facies marbles from the Queyras unit (Western Alps) : its occurrence and its significance

Autor(en): **Ballèvre, Michel / Lagabrielle, Yves**

Objektyp: **Article**

Zeitschrift: **Schweizerische mineralogische und petrographische Mitteilungen
= Bulletin suisse de minéralogie et pétrographie**

Band (Jahr): **74 (1994)**

Heft 2

PDF erstellt am: **21.09.2024**

Persistenter Link: <https://doi.org/10.5169/seals-56342>

Nutzungsbedingungen

Die ETH-Bibliothek ist Anbieterin der digitalisierten Zeitschriften. Sie besitzt keine Urheberrechte an den Inhalten der Zeitschriften. Die Rechte liegen in der Regel bei den Herausgebern.

Die auf der Plattform e-periodica veröffentlichten Dokumente stehen für nicht-kommerzielle Zwecke in Lehre und Forschung sowie für die private Nutzung frei zur Verfügung. Einzelne Dateien oder Ausdrucke aus diesem Angebot können zusammen mit diesen Nutzungsbedingungen und den korrekten Herkunftsbezeichnungen weitergegeben werden.

Das Veröffentlichen von Bildern in Print- und Online-Publikationen ist nur mit vorheriger Genehmigung der Rechteinhaber erlaubt. Die systematische Speicherung von Teilen des elektronischen Angebots auf anderen Servern bedarf ebenfalls des schriftlichen Einverständnisses der Rechteinhaber.

Haftungsausschluss

Alle Angaben erfolgen ohne Gewähr für Vollständigkeit oder Richtigkeit. Es wird keine Haftung übernommen für Schäden durch die Verwendung von Informationen aus diesem Online-Angebot oder durch das Fehlen von Informationen. Dies gilt auch für Inhalte Dritter, die über dieses Angebot zugänglich sind.

Garnet in blueschist-facies marbles from the Queyras unit (Western Alps): its occurrence and its significance

by Michel Ballèvre¹ and Yves Lagabrielle²

Abstract

Garnet-bearing marbles are described from the Queyras unit (Western Alps), which was submitted to an early low-grade blueschist-facies metamorphism. Observed assemblages are, in addition to quartz and calcite or aragonite:

- garnet + sodic amphibole + phengite + titanite;
- garnet + sodic pyroxene;
- garnet + sodic amphibole + lawsonite + phengite + titanite + pyrite.

Garnet is essentially a ternary almandine-spessartine-grossular solid solution. Grossular contents are about 20–25 mole per cent, irrespective of the studied sample whereas the almandine and spessartine contents depend on the studied sample. Sodic amphibole is glaucophane/ferroglaucophane (sample PYL 3-1a) or ferroglaucophane (sample CP 23). Phengite contains 3.5 to 3.6 Si per formula unit. Garnet is only found in marbles derived from carbonate oozes of probable Upper Jurassic age, resting directly upon the ophiolitic basement. This accounts for the presence of elements such as Mn or Na in the sediments, which most probably result from the hydrothermal alteration of the oceanic crust.

Keywords: garnet, marble, blueschist facies, Queyras, Western Alps.

Introduction

The significance of metamorphic garnet depends on the associated paragenesis and its chemical composition. These two parameters are controlled by the bulk-rock chemistry and by the P-T conditions during the metamorphic event.

Garnet is abundant in the oceanic units of the Western Alps which were submitted to an early high-grade blueschist-facies or eclogite-facies event (for a review, see DROOP et al., 1990). In contrast, garnet is not found in the oceanic units where the early metamorphic event occurred under low-grade blueschist facies. The only known exceptions are andradite-rich garnets within skarns (CARON and SALIOT, 1969; DESMONS, 1990). We report here for the first time an occurrence of pyralpsite garnet in this type of unit and show that

its growth was controlled by bulk-rock composition.

Geological setting

Garnet is found in blueschist-facies marbles from the Queyras unit, one of the two main oceanic units in the southern part of the Western Alps (e.g. BALLÈVRE et al., 1990) (Fig. 1). These two units are only briefly described here.

The *Viso unit* (LOMBARDO et al., 1978) is made of several imbricated slices of oceanic lithosphere, where ophiolites are much more abundant than sediments. Coherent sections through the oceanic lithosphere are locally well exposed (LOMBARDO and POGNANTE, 1982). To the top of these sections, the sedimentary cover has a low thickness

¹ Laboratoire de Tectonique, Géosciences Rennes (UPR-CNRS 4661), Université de Rennes, F-35042 Rennes Cedex, France.

Present address: Department of Applied Geology, The University of New South Wales, P.O. Box 1, Kensington NSW 2033, Australia.

² URA-CNRS 1278 et GDR "Genèse et évolution des domaines océaniques", Université de Bretagne occidentale, F-29287 Brest, France.

(about 20 m) and is mainly made of manganiferous quartzites and micaschists followed by calcschists. Some layers show abundant detrital ophiolitic rocks (LAGABRIELLE, 1987; LAGABRIELLE and POLINO, 1988).

The Viso unit was submitted to an eclogite-facies metamorphism, as recorded by garnet-omphacite-rutile assemblages within the metagabbros and metabasalts (LOMBARDO et al., 1978; KIÉNAST and MESSIGA, 1987; LARDEAUX et al., 1987; PHILLIPOT and KIÉNAST, 1989). These early assemblages were variably retrogressed during a greenschist-facies event.

In the *Queyras unit*, ophiolitic rocks constitute lenses of small size and diverse lithologies within abundant sediments, which are dominantly made of calcschists. It is thus not possible to observe a coherent section through the oceanic lithosphere. This can be interpreted in several ways and could result from several processes:

- olistolith development associated to the opening of the ocean (LEMOINE and TRICART, 1979) or to the beginning of the convergence (LAGABRIELLE and POLINO, 1988);
- intense boudinage of the oceanic lithosphere during the Alpine deformation (TRICART and LEMOINE, 1986);
- imbrication of oceanic material in an accretionary prism (STAMPFLI and MARTHALER, 1990)

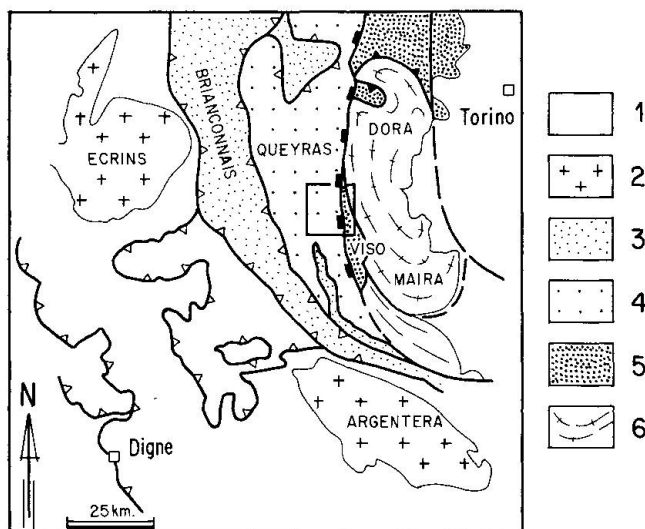

Fig. 1 Location of the studied area in the southern part of the Western Alps (modified from BALLÈVRE et al., 1990). 1 - External zone: sedimentary cover; 2 - External zone: Palaeozoic basement; 3 - Briançonnais zone; 4 - Oceanic units with low-grade blueschist facies metamorphism; 5 - Oceanic units with high-grade blueschist-facies and eclogite-facies metamorphism; 6 - Piemontese zone (Dora-Maira massif). The location of the studied area is shown by a rectangle.

or during the Alpine collision (LAGABRIELLE and POLINO, 1988).

Some of the ophiolitic lenses preserve their sedimentary cover, which is in primary contact with basalts, gabbros as well as serpentinized peridotites (for a review, see LAGABRIELLE et al., 1984). The sedimentary sequence begins with ophicalcites (CABY et al., 1987) or red to green bedded metacherts, locally preserving radiolarians of Oxfordian to Kimmeridgian age (DE WEVER and CABY, 1981; SCHAAF et al., 1981; DE WEVER et al., 1987). The siliceous oozes are followed by carbonate oozes, now marbles, of probable Upper Jurassic age. Marbles are overlain by calcschists of presumed Cretaceous age.

The Queyras unit was submitted to a low-grade blueschist-facies metamorphism, as revealed by the occurrence of blue amphibole, sodic pyroxene, clinozoisite, lawsonite and pumpellyite within metabasites (e.g. BOCQUET, 1974; STEEN, 1975; CARON, 1977; CABY et al., 1978; MEVEL and KIÉNAST, 1980; SALIOT et al., 1980; POGNANTE and KIÉNAST, 1987; DESMONS, 1990), lawsonite, chloritoid and carpholite within metasediments (e.g. CHATTERJEE, 1971; CARON, 1974 and 1977; STEEN and BERTRAND, 1977; GOFFÉ and CHOPIN, 1986). A

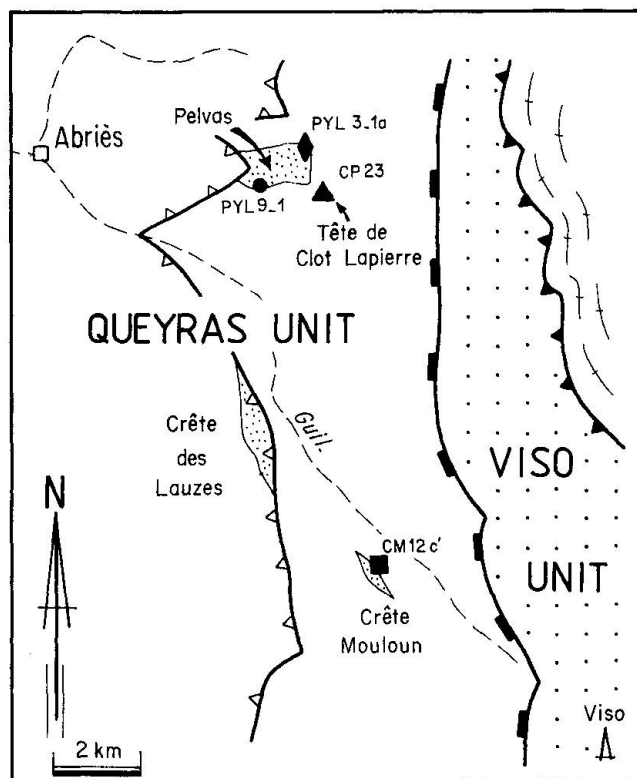

Fig. 2 Location of the studied samples in the Queyras unit. The structural map is adapted from LAGABRIELLE and POLINO (1988).

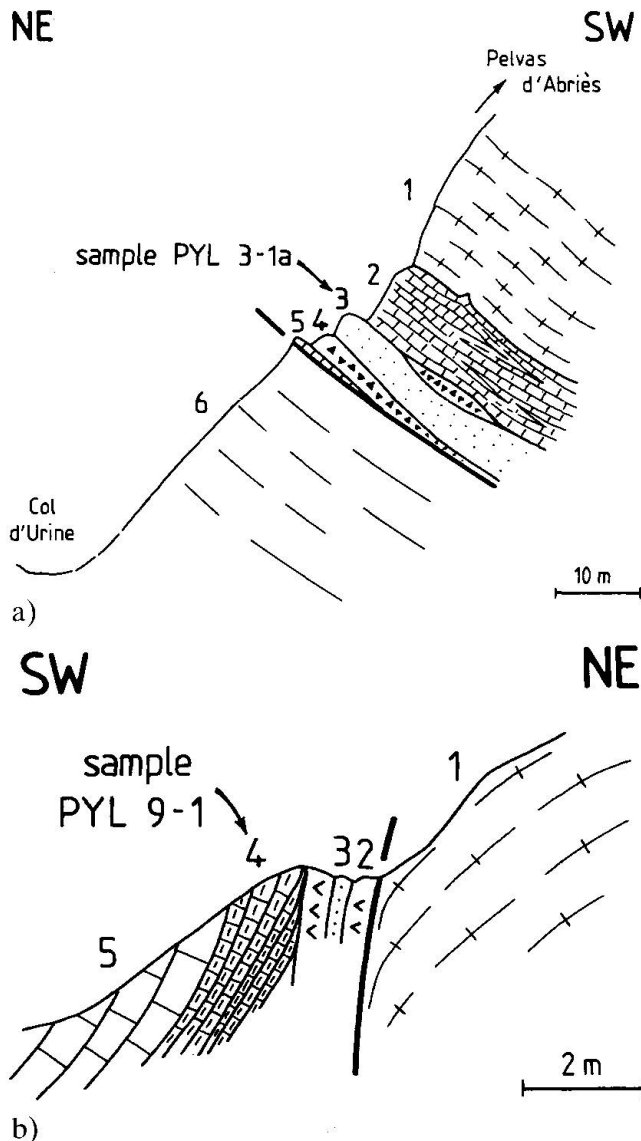

Fig. 3 Location of the studied samples from the Pelvas d'Abriès in the stratigraphic Mesozoic sequences. a) Col d'Urine section. 1 – Metagabbros; 2 – Marbles; 3 – Gabbroic breccias; 4 – Serpentinic breccias; 5 – Marbles; 6 – Calcschists. b) Sagne Clause section. 1 – Metagabbros; 2 – Serpentinities; 3 – Quartzites; 4 – Thinly-bedded marbles; 5 – Thicker-bedded marbles.

greenschist-facies overprint is unequally developed in most lithologies.

Because the Viso and Queyras units had different P-T histories during the Alpine history, metamorphic parageneses are not equally distributed. The spatial distribution of some minerals is shown by several authors on regional-scale maps (e.g. BEARTH, 1962; BOCQUET, 1971; CHATTERJEE, 1971; SALIOT, 1973; CARON, 1974 and 1977). Data for garnet can be summarized as follows.

1. Garnet is abundant in the Viso unit. It is known in Fe-Ti or Mg-metagabbros, metabasalts

as well as manganese quartzites, micaschists and calcschists.

2. In the Queyras unit, garnet has never been found until now within metabasites, metapelites or metacherts. We report here the first occurrence of garnet within Upper Jurassic marbles from the Queyras unit.

Petrography

The studied samples were collected from three localities in the Guil valley, namely the Pelvas d'Abriès, the Tête de Clot Lapierre and the Crête Mouloun (Fig. 2).

The *Pelvas d'Abriès* or Palavas (2929 m) is a slice of metagabbros with minor metaperidotites and their associated Mesozoic cover (BEARTH et al., 1975; LAGABRIELLE, 1982; LAGABRIELLE et al., 1985). To the East (col d'Urine), the metasedimentary cover including marbles and various ophiolite-rich detrital beds is in stratigraphic contact with the gabbros but the entire section is now overturned (Fig. 3a). To the West (Sagne Clause), the metasediments are in fault contact with the gabbros (Fig. 3b). Garnets have been recovered from marble layers exposed along both sections (Fig. 3).

– *Sample PYL 3-1a* shows a foliation defined by the shape fabric of calcite, quartz, white mica and blue amphibole. The amphiboles mark a pronounced East-West trending mineral elongation. The primary paragenesis consists of calcite + quartz + white mica + blue amphibole + titanite. Garnet is poikiloblastic with numerous inclusions of calcite. Retrograde transformations are only poorly developed. Some chlorite grew at the expense of blue amphibole while sheaves of rutile needles result from the breakdown of titanite.

– *Sample PYL 9-1* consists of a succession of millimeter-thick layers with various mineralogical compositions. One of these layers contain garnet associated to calcite, quartz and microboudinaged clasts.

The *Tête de Clot Lapierre* (2730 m) is a small ophiolitic body mainly consisting of metabasalts (LAGABRIELLE, 1982). A meter-thick layer of marbles occur just above the metabasalts. *Sample CP 23* has been collected within these marbles. The foliation is defined by the shape fabric of calcite, white mica and quartz and bears an East-West trending stretching lineation marked by the alignment of microboudinaged blue amphiboles. *Sample CP 23* presents numerous rectangular- or lozenge-shaped pseudomorphs after lawsonite, now consisting almost exclusively of zoisite, with a minor amount of calcite and white

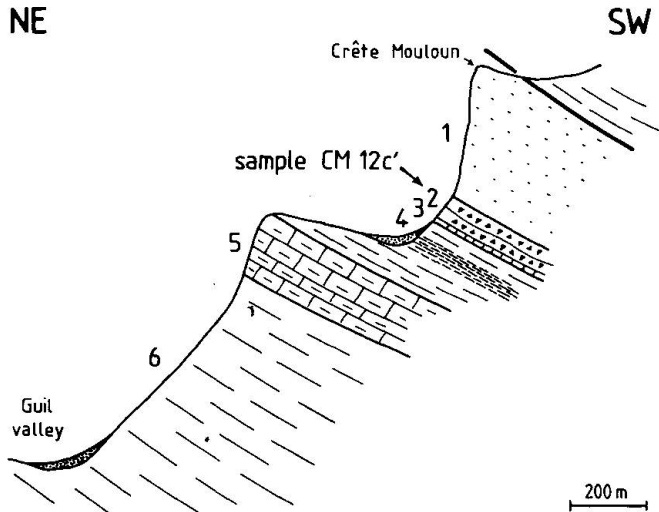

Fig. 4 Location of the studied samples from the Crête Mouloun. 1 - Metabasalts, including some pillow-lava flows and breccias; 2 - Metasediments with abundant layers of detrital ultrabasic and basic material; 3 - impure marbles; 4 - black siliceous schists; 5 - phyllitic marbles; 6 - calcschists.

mica. In addition, euhedral garnet (2–5 mm in diameter) is rarely found. Epidote occurs either as discrete grains within the deformed matrix or overgrowing zoisite at the margins of lawsonite pseudomorphs.

The *Crête or Roche Mouloun* (2678 m) consists of almost undeformed basaltic pillows and breccias. Associated metasediments are characterized by the abundance of detrital basic and ultrabasic material (LE MER et al., 1986). Garnet has been discovered within marbles (*sample CM 12c'*) from the uppermost part of the sedimentary sequence (Fig. 4). Foliation is defined by the shape fabric of calcite, quartz, white mica and chlorite. Garnet has a small size (20–50 μm) and shows a poikilitic core and a clear rim.

Mineralogy

A preliminary investigation of these samples was made by C. Mével (see SCAILLET, 1986; LAGABRIELLE, 1987). New mineral analyses were performed with an electron microprobe (Microsonde Ouest, Brest). Operating conditions were 15 kV accelerating voltage, 15 nA beam current and 6 s counting time. Natural minerals were used as standards.

Calcium carbonate is by far the most abundant phase in the three samples investigated. It is nearly pure and contains only trace amounts of FeO, MnO and MgO. We assume that calcium carbonate is calcite and found no evidence in favour of

recrystallization of large aragonite grains. Dolomite has not been identified.

Garnet always presents a negligible pyrope content (lower than 1 mole per cent) and a rather high grossular content (from 15 to 25 mole per cent) (Tab. 2 and Fig. 5). The almandine and spessartine contents strongly differ from one sample to the other (Fig. 5). Garnets from samples PYL 3-1a and PYL 9-1 do not show any significant zoning or differences of composition between grains. A slight core-rim zoning is present in sample CP 23 (Fig. 5). Significant variations in the chemical composition are observed only in sample CM 12c', where garnet grains from the same thin section show a large scatter (Fig. 5). The possible reasons for this dispersal are not yet clearly established.

Tab. 1 Observed mineral assemblages within the studied marbles from the Queyras unit.

	PYL 3-1a	PYL 9-1	CP 23	CM 12c'
calcite	+	+	+	+
quartz	+	+	+	+
garnet	+	+	+	+
Na-amphibole	+		+	
lawsonite			+	
phengite	+		+	+
chlorite				+
titanite	+		+	
pyrite			+	

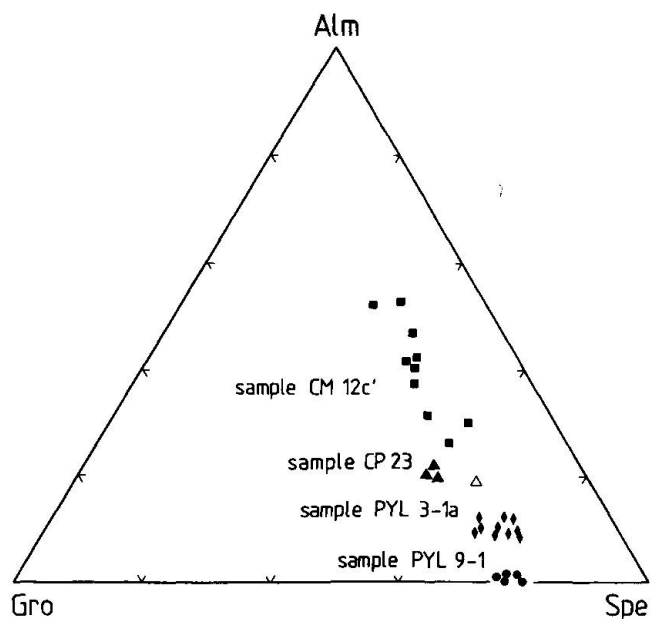

Fig. 5 Garnet composition in the almandine (Alm) – spessartine (Spe) – grossular (Gro) triangle. Open and filled symbols for sample CP 23 represent core and rim analyses, respectively.

Tab. 2 Representative analyses of garnet. Structural formulae are calculated on a basis of 8 cations.

	PYL 3-1a			PYL 9-1			CP 23		CM 12c'		
SiO ₂	36.07	36.33	36.82	37.19	36.68	36.96	37.38	37.40	38.18	36.66	36.84
TiO ₂	0.40	0.28	0.30	0.35	0.48	0.36	0.25	0.25	0.04	0.26	0.00
Al ₂ O ₃	20.03	20.31	20.52	20.26	20.26	20.29	19.78	20.66	20.60	20.05	20.67
Cr ₂ O ₃	0.00	0.00	0.00	0.08	0.06	0.01	0.03	0.02	0.00	0.00	0.00
FeO	5.10	5.06	5.10	1.75	1.71	1.72	8.71	9.59	17.98	11.98	23.50
MnO	30.97	31.53	30.96	33.01	32.02	31.51	26.67	23.51	18.01	23.17	14.58
MgO	0.10	0.10	0.15	0.03	0.04	0.05	0.06	0.08	0.23	0.11	0.27
CaO	6.64	6.51	7.48	8.27	9.36	9.25	6.90	8.08	5.17	7.06	5.12
Na ₂ O	0.03	0.04	0.00	0.00	0.02	0.03	0.04	0.07	0.00	0.00	0.04
K ₂ O	0.01	0.02	0.02	0.03	0.01	0.00	0.00	0.00	0.00	0.00	0.00
Total	99.35	100.18	101.35	100.97	100.64	100.18	99.82	99.66	100.21	99.29	101.02
Si	2.950	2.946	2.946	2.982	2.944	2.976	3.040	3.022	3.074	2.996	2.971
Al ^{IV}	0.050	0.054	0.054	0.018	0.056	0.024	0.000	0.000	0.000	0.004	0.029
Al ^{VI}	1.881	1.888	1.881	1.897	1.861	1.903	1.897	1.968	1.956	1.929	1.937
Ti	0.025	0.017	0.018	0.021	0.029	0.022	0.015	0.015	0.002	0.016	0.000
Cr	0.000	0.000	0.000	0.005	0.004	0.001	0.002	0.001	0.000	0.000	0.000
Fe ³⁺	0.094	0.095	0.101	0.077	0.106	0.075	0.045	0.000	0.000	0.055	0.063
Fe ²⁺	0.254	0.248	0.240	0.041	0.009	0.041	0.547	0.648	1.221	0.764	1.522
Mn	2.146	2.166	2.098	2.242	2.177	2.150	1.838	1.609	1.229	1.604	0.996
Mg	0.012	0.012	0.018	0.004	0.005	0.006	0.007	0.010	0.028	0.013	0.032
Ca	0.582	0.566	0.641	0.711	0.805	0.798	0.601	0.700	0.446	0.618	0.443
Na	0.005	0.006	0.000	0.000	0.003	0.005	0.006	0.011	0.000	0.000	0.006
K	0.001	0.002	0.002	0.003	0.001	0.000	0.000	0.000	0.000	0.000	0.000
Alm	8.50	8.29	8.02	1.35	0.29	1.38	18.28	21.85	41.57	25.46	50.86
Spe	71.66	72.40	69.99	74.82	72.67	71.77	61.39	54.25	42.17	53.48	33.28
Pyr	0.41	0.40	0.60	0.12	0.16	0.20	0.24	0.32	0.95	0.45	1.08
Gro	15.46	15.15	17.41	20.27	22.24	23.41	18.00	23.03	15.23	18.24	12.68
And	3.97	3.76	3.96	3.27	4.51	3.22	2.03	0.51	0.08	2.38	2.10
Ouv	0.00	0.00	0.00	0.17	0.13	0.02	0.06	0.04	0.00	0.00	0.00

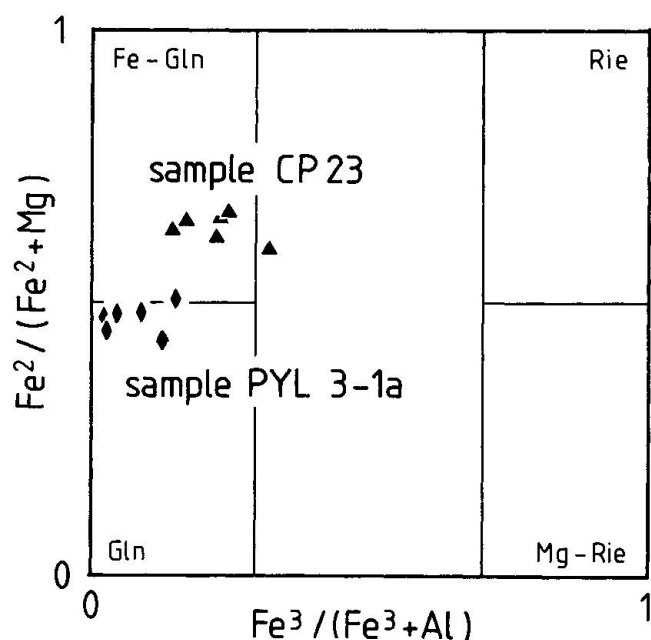

Fig. 6 Amphibole composition in the classification of LEAKE (1978).

Structural formulae of *blue amphiboles* have been calculated using the same method as REYNARD and BALLÈVRE (1988). In the studied rocks, the $Fe^2/(Fe^2 + Mg)$ and $Fe^3/(Fe^3 + Al)$ ratios are not significantly dependent on the chosen normalization. They are represented in the diagram of LEAKE (1978) (Tab. 3 and Fig. 6) using the normalization giving the highest ferric iron content (SUM Mg for sample PYL 3-1a and SUM Na for sample CP 23). Blue amphiboles from sample PYL 3-1a plot at the limit between the glaucophane and ferroglaucophane fields while those from sample CP 23 are ferroglaucophanes.

Lawsonite from sample CP 23 is now totally replaced by *zoisite* with a very low iron content. *Epidote* overgrowing *zoisite* or in the matrix is distinctly richer in iron than *zoisite*. Microboudinaged clasts from sample PYL 9-1 have only given analyses of poor quality, even with a defocused beam.

Analysed white micas from samples PYL 3-1a, CP 23 and CM 12c' are *phengites* with a high cela-

Tab. 3 Representative analyses of blue amphibole. Structural formulae are calculated as indicated in the text.

	PYL 3-1a		CP23	
SiO ₂	57.19	57.80	55.45	55.44
TiO ₂	0.09	0.28	0.31	0.00
Al ₂ O ₃	10.97	11.90	7.54	8.63
Cr ₂ O ₃	0.00	0.00	0.00	0.16
FeO	13.42	12.59	20.87	21.05
MnO	0.12	0.19	0.23	0.30
MgO	7.70	8.11	5.89	4.80
CaO	0.18	0.17	0.63	0.47
Na ₂ O	7.53	7.74	6.66	6.74
K ₂ O	0.00	0.00	0.00	0.03
Total	97.20	98.78	97.58	97.62
Si	7.995	7.924	7.952	7.971
Al ^{IV}	0.005	0.076	0.048	0.029
Al ^{VI}	1.803	1.848	1.227	1.434
Ti	0.009	0.029	0.033	0.000
Cr	0.000	0.000	0.000	0.018
Fe ³⁺	0.089	0.062	0.606	0.451
Fe ²⁺	1.481	1.382	1.897	2.080
Mn	0.014	0.022	0.028	0.037
Mg	1.605	1.624	1.259	1.029
Ca	0.027	0.025	0.097	0.072
Na	2.041	2.058	1.852	1.879
K	0.000	0.000	0.000	0.006
Total	15.068	15.083	15.000	15.006

donitic substitution (of the order of 3.5–3.6 Si atom per formula unit). Paragonite has not been found (Tab. 4).

Chlorite from sample CM 12c' presents higher amounts of Al^{VI} than Al^{IV}, which suggest that no ferric iron is present. Assuming all iron to be divalent, the Fe²⁺/(Fe²⁺ + Mg) ratio is about 0.55–0.60.

Titanite is nearly pure, with a low Al₂O₃ content (up to 1.5 weight per cent). The only opaque phase is *pyrite*.

P-T estimates

Accurate estimates of the P-T conditions of the blueschist-facies event in the studied rocks are quite difficult because the observed assemblages present a high variance. The studied rocks depart strongly from simple systems such as K₂O–FeO–MgO–Al₂O₃–SiO₂–H₂O and CaO–MgO–Al₂O₃–SiO₂–H₂O–CO₂, which are used as reference for the study of phase relations within metapelites and marbles, respectively. Several comments are nevertheless useful.

1. The garnet-bearing assemblages belong to the low-grade blueschist-facies, as shown by the costability of garnet with sodic amphibole (sam-

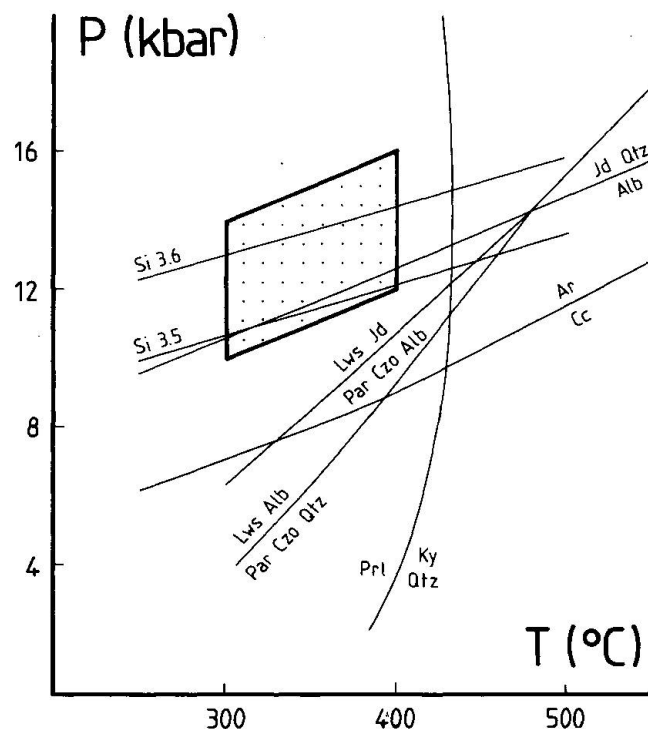

Fig. 7 Estimated P-T conditions (box) for the early, low-grade blueschist-facies event in the Queyras unit. Equilibrium curves were calculated using the dataset of BERMAN (1988) for a unit H₂O activity. Calcite-aragonite transition after JOHANNES and PUHAN (1971). Alb: equilibrium albite; Ar: aragonite; Cc: calcite; Czo: clinozoisite; Jd: jadeite; Ky: kyanite; Lws: lawsonite; Par: paragonite; Prl: pyrophyllite; Qtz: a-quartz.

ple PYL 3-1a) or sodic amphibole + lawsonite (sample CP 23).

2. The FeMg₋₁ partitioning between garnet and phengite is not properly calibrated for estimating temperatures in the studied rocks, mainly because of the spessartine-rich composition of garnet. Maximum temperatures of the order of 350–450 °C are compatible with observed mineral assemblages within the studied rocks, especially with the occurrence of sodic amphibole + lawsonite (e.g. EVANS, 1990).

3. A rough estimate of minimum pressures can be made by linearly extrapolating towards lower temperatures experimental data for the Si-content of phengites in the KMAH system (MASSONNE and SCHREYER, 1987). This gives minimum pressures of the order of 12–14 kbar at 400 °C (Fig. 7). One could argue that there is no sound basis for such a linear extrapolation and that the chemistry of the phengites is not buffered by the same assemblage as in the experimental study. However, the obtained pressure values are consistent with the presence of the assemblage jadeite + quartz (Fig. 7), which has been reported

Tab. 4 Representative analyses of phengite and chlorite. Structural formulae are calculated on a basis of 11 and 14 oxygens, respectively.

	PYL 3-1a		CP 23		CM 12c'			
SiO ₂	54.77	53.56	53.14	52.40	52.10	52.65	24.74	24.37
TiO ₂	0.03	0.04	0.27	0.00	0.18	0.15	0.00	0.08
Al ₂ O ₃	21.06	23.10	22.35	23.08	21.33	21.24	21.11	21.63
Cr ₂ O ₃	0.00	0.00	0.01	0.01	0.00	0.01	0.03	0.00
FeO	3.17	2.34	4.27	4.54	4.77	4.46	27.73	29.35
MnO	0.30	0.42	0.21	0.18	0.05	0.02	0.79	0.56
MgO	4.85	4.79	3.62	3.67	3.29	3.49	12.29	11.03
CaO	0.12	0.32	0.00	0.08	0.11	0.14	0.24	0.13
Na ₂ O	0.08	0.09	0.01	0.08	0.05	0.06	0.00	0.02
K ₂ O	10.72	11.20	11.23	11.54	10.98	10.78	0.00	0.00
Total	95.10	95.86	95.11	95.58	92.86	93.00	86.93	87.17
Si	3.673	3.569	3.596	3.545	3.620	3.639	2.679	2.650
Al ^{IV}	0.327	0.431	0.404	0.455	0.380	0.361	1.321	1.350
Al ^{VI}	1.339	1.384	1.379	1.387	1.368	1.370	1.374	1.424
Ti	0.002	0.002	0.014	0.000	0.009	0.008	0.000	0.007
Cr	0.000	0.000	0.001	0.001	0.000	0.001	0.003	0.000
Fe ²⁺	0.178	0.130	0.242	0.257	0.277	0.258	2.512	2.670
Mn	0.017	0.024	0.012	0.010	0.003	0.001	0.072	0.052
Mg	0.485	0.476	0.365	0.370	0.341	0.360	1.984	1.788
Ca	0.009	0.023	0.000	0.006	0.008	0.010	0.028	0.015
Na	0.010	0.012	0.001	0.010	0.007	0.008	0.000	0.004
K	0.917	0.952	0.970	0.996	0.974	0.951	0.000	0.000
Total	6.956	7.003	6.984	7.037	6.987	6.967	9.972	9.959

from several localities in the Queyras unit (CABY et al., 1971; SALIOT, 1973; CARON, 1977; SALIOT et al., 1980). Because the calcite-aragonite equilibrium curve is located at lower pressures than the albite-jadeite-quartz equilibrium curve (Fig. 7), one should expect to find aragonite in the Queyras unit but no aragonite has been found up to now (GILLET and GOFFÉ, 1988). If initially present, aragonite was most probably totally inverted during the late greenschist-facies overprint. The inversion could have been facilitated by the late, greenschist-facies, ductile deformation (cf. sample CP 23).

4. The observed assemblages crystallized at very low or low values of CO₂ activity, as shown by the presence of titanite (instead of rutile) coexisting with calcite and quartz in samples PYL 3-1a and CP 23. Moreover, sample CP 23 displays the assemblage lawsonite + calcite + quartz, which is also indicative of low values of X(CO₂). Experimental data (NITSCH, 1972; JACOBS and KERRICK, 1981) and thermodynamic calculations (e.g. FREY, 1987) show that the assemblages titanite + calcite + quartz and lawsonite + calcite are only stable for values of X(CO₂) lower than about 3 and 8 mole per cent, respectively, at 10 kbar, 400 °C.

The significance of garnet in the blueschist-facies marbles

Garnet-bearing assemblages in the Queyras unit are only found in marbles of probable Upper Jurassic age resting directly on their ophiolitic substratum (Figs 3 and 4). Two main hypotheses can be proposed in order to explain the occurrence of these garnets.

1. Garnet growth could have resulted from higher P-T conditions than previously assumed either for the Queyras unit as a whole or, taking into account the fact that the studied rocks are located in a restricted area, for that particular area within the Queyras unit.

2. Garnet growth was mainly controlled by the bulk-rock chemistry.

Checking the first hypothesis proves to be difficult because our P-T estimates are not as precise as required and because few reliable petrological data are currently available on the Queyras unit. Previous investigations suggest increasing P-T conditions from West to East within the Queyras unit (e.g. SALIOT, 1973; CARON, 1977) but it remains uncertain whether the increase is related to the early high-pressure event or to the late greenschist-facies overprint or both. This P-T gradient could explain why garnets are only found in

Jurassic marbles from the easternmost part of the Queyras unit (Figs 1 and 2).

No representative analyses of the studied samples could be obtained, because the thickness of the garnet-bearing layers are too small. This precludes a direct correlation between the garnet chemistry and the bulk-rock composition. Nevertheless, the lack of garnet in lithologies other than Jurassic marbles of the same part of the Queyras unit demonstrates that the bulk-rock composition of the sediment played a major role. Indeed, the studied rocks were originally carbonate oozes sedimented on top of the oceanic basement. These oozes were impure carbonates, i.e. with a significant contribution of the ophiolitic substratum, either directly (detrital clasts) or through hydrothermal alteration of the ophiolitic rocks. Though centimeter- to decimeter-thick layers of impure marbles are also found within calcschists of presumed Cretaceous age, garnet as well as blue amphibole have not been found within such layers. This fact is easily explained, considering that the contribution of the ophiolitic substratum to the sedimentation was not possible or reduced, because either these sediments were located at a long distance from the active rift or the ophiolitic basement was then totally covered by Upper Jurassic sediments.

Finally, this study confirms the lack of almandine-rich garnet in the Queyras unit, at odds with its abundance in various lithologies in the Viso unit. This distribution is known since BEARTH (1962) and was later used in order to define a "garnet isograd" (SALIOT, 1973). This latter coincides with the fault separating the Queyras unit to the West from the Viso unit to the East, i.e. low-grade blueschists to the West from high-grade blueschists and eclogites to the East. Recent structural investigations revealed ductile normal movement along the fault (BALLÈVRE et al., 1990; PHILLIPOT, 1990). This movement is responsible of the P-T gap now observed.

Conclusion

The main conclusions of this study are as follows.

1. Garnet is rarely found in blueschist-facies marbles from the Queyras unit (Western Alps), where it coexisted with glaucophane-ferroglaucophane or ferroglaucophane + lawsonite, in addition to quartz, calcite (formerly aragonite?) and phengite (Tab. 1).

2. The studied garnets show peculiar chemical compositions (Tab. 2 and Fig. 5), with very high spessartine, low-to moderate almandine and low

grossular contents. Their pyrope content is negligible.

3. Garnet growth was mainly controlled by the bulk-rock chemistry. P-T conditions during garnet growth are estimated at about 10–14 kbar, 300–400 °C.

Acknowledgements

Many thanks are due to Marcel Bohn (Microsonde Ouest, Brest) for his help during our microprobe work. Catherine Dupureur kindly gave us sample CP 23. Critical reviews by J. Desmons and C. de Capitani helped to improve our manuscript.

References

- BALLÈVRE, M., MERLE, O. and LAGABRIELLE, Y. (1990): Tertiary ductile normal faulting as a consequence of lithospheric stacking in the western Alps. *Mém. Soc. géol. France*, 156, 227–236.
- BEARTH, P. (1962): Versuch einer Gliederung alpin-metamorpher Serien der Westalpen. *Schweiz. Mineral. Petrogr. Mitt.*, 42, 127–138.
- BEARTH, P., BOCQUET, J., DAL PIAZ, G.V., NERVO, R. and POLINO, R. (1975): Structures de cumulat dans les ophiolites du Pelvas (Alpes franco-italiennes): confirmation d'une origine océanique. *Pétrologie*, 1, 237–242.
- BERMAN, R.G. (1988): Internally-consistent thermodynamic data for minerals in the system Na₂O–K₂O–CaO–MgO–FeO–Fe₂O₃–Al₂O₃–SiO₂–TiO₂–H₂O–CO₂. *J. Petrol.*, 29, 445–522.
- BOCQUET, J. (1971): Cartes de répartition de quelques minéraux du métamorphisme alpin dans les Alpes franco-italiennes. *Eclogae geol. Helv.*, 64, 71–103.
- BOCQUET, J. (1974): Etudes minéralogiques et pétrologiques sur les métamorphismes d'âge alpin dans les Alpes françaises. Thèse Doctorat Etat, Univ. Grenoble, 490 p.
- CABY, R., MICHARD, A. and TRICART, P. (1971): Découverte d'une brèche polygénique à éléments granitoïdes dans les ophiolites métamorphiques piémontaises. *C.R. Acad. Sci. Paris, (D)* 273, 999–1002.
- CABY, R., KIÉNAST, J.R. and SALIOT, P. (1978): Structure, métamorphisme et modèle d'évolution tectonique des Alpes occidentales. *Rev. Géog. Phys. Géol. Dyn.*, 20, 307–322.
- CABY, R., DUPUY, C. and DOSTAL, J. (1987): The very beginning of the Ligurian Tethys: petrological and geochemical evidence from the oldest ultramafite-derived sediments in Queyras, Western Alps (France). *Eclogae geol. Helv.*, 80, 223–240.
- CARON, J.-M. (1974): Rapports entre diverses "générations" de lawsonite et les déformations dans les Schistes lustrés des Alpes cottiennes septentrionales (France et Italie). *Bull. Soc. géol. France*, (7) XVI, 255–263.
- CARON, J.-M. (1977): Lithostratigraphie et tectonique des Schistes lustrés dans les Alpes cottiennes septentrionales et en Corse orientale. *Sci. Terre Mémoires*, 48, 326 p.
- CARON, J.-M. and SALIOT, P. (1969): Nouveaux gisements de lawsonite et de jadéite dans les Alpes franco-italiennes. *C.R. Acad. Sci. Paris, (D)* 268, 3153–3156.

- CHATTERJEE, N.D. (1971): Phase equilibria in the alpine metamorphic rocks of the environs of the Dora-Maira massif, western Italian Alps. *Neues Jahrb. Mineral. Abh.*, 114, 181–210.
- DESMONS, J. (1990): Sur quelques minéraux de la zone piémontaise (zone du Combin) dans les Alpes françaises. *Géol. Alpine*, 66, 23–38.
- DE WEVER, P. and CABY, R. (1981): Datation de la base des Schistes lustrés postophiolitiques par des Radio-laires (Oxfordien sup.–Kimméridgien moy.) dans les Alpes cottiennes (St-Véran, France). *C.R. Acad. Sci. Paris, (II)* 292, 467–472.
- DE WEVER, P., BAUMGARTNER, P.O. and POLINO, R. (1987): Précision sur la datation de la base des Schistes lustrés postophiolitiques dans les Alpes cottiennes. *C.R. Acad. Sci. Paris, (II)* 305, 487–491.
- DROOP, G.T.R., LOMBARDO, B. and POGNANTE, U. (1990): Formation and distribution of eclogite-facies rocks in the Alps. In CARS-WELL, D.A. (ed.): "Eclogite-facies rocks", Blackie, Glasgow and London, 225–259.
- EVANS, B.W. (1990): Phase relations of epidote-blue-schists. *Lithos*, 25, 3–23.
- FREY, M. (1987): Very low-grade metamorphism of clastic sedimentary rocks. In FREY, M. (ed.): "Low temperature metamorphism", Blackie, Glasgow and London, 9–58.
- GILLET, P. and GOFFÉ, B. (1988): On the significance of aragonite occurrences in the Western Alps. *Contrib. Mineral. Petrol.*, 99, 70–81.
- GOFFÉ, B. and CHOPIN, C. (1986): High-pressure metamorphism in the western Alps: zoneography of metapelites, chronology and consequences. *Schweiz. Mineral. Petrogr. Mitt.*, 66: 41–52.
- JACOBS, G.K. and KERRICK, D.M. (1981): Devolatilization equilibria in H_2O-CO_2 and H_2O-CO_2-NaCl fluids: an experimental and thermodynamic evaluation at elevated pressures and temperatures. *Am. Mineral.*, 66, 1135–1153.
- JOHANNES, W. and PUHAN, D. (1971): The calcite-aragonite transition, reinvestigated. *Contrib. Mineral. Petrol.*, 31, 28–58.
- KIÉNAST, J.R. and MESSIGA, B. (1987): Cr-rich Mg-chloritoid, a first record in high pressure metagabbros from Monviso (Cottian Alps), Italy. *Mineral. Mag.*, 51, 681–687.
- LAGABRIELLE, Y. (1982): Ophiolites et croûte océanique. Tectonique et environnement sédimentaire: apports des données océaniques à l'interprétation géologique des séries ophiolitifères du Queyras. Thèse 3^e cycle, Univ. Bretagne occidentale, 189 p.
- LAGABRIELLE, Y. (1987): Les ophiolites: marqueurs de l'histoire tectonique des domaines océaniques. Le cas des Alpes franco-italiennes (Queyras, Piémont): comparaison avec les ophiolites d'Antalya (Turquie) et du Coast Range de Californie. Thèse Doctorat Etat, Univ. Bretagne occidentale, 350 p.
- LAGABRIELLE, Y. and POLINO, R. (1988): Un schéma structural du domaine des Schistes lustrés ophiolitifères au nord-ouest du massif du Mont Viso (Alpes sud-occidentales) et ses implications. *C.R. Acad. Sci. Paris, (II)* 306, 921–928.
- LAGABRIELLE, Y., POLINO, R., AUZENDE, J.-M., BLANCHET, R., CABY, R., FUDRAL, F., LEMOINE, M., MEVEL, C., OHNENSTETTER, M., ROBERT, D. and TRICART, P. (1984): Les témoins d'une tectonique intraocéanique dans le domaine téthysien: analyse des rapports entre les ophiolites et leur couverture métasédimentaire dans la zone piémontaise des Alpes franco-italiennes. *Ophioliti*, 9, 67–88.
- LAGABRIELLE, Y., LEMOINE, M. and TRICART, P. (1985): Paléotectonique océanique et déformations alpines dans le massif ophiolitique du Pelvas d'Abriès (Alpes occidentales, Queyras, France). *Bull. Soc. géol. France*, (8) I, 473–479.
- LARDEAUX, J.-M., NISIO, P. and BOUDEULLE, M. (1987): Deformational and metamorphic history at the Lago Superiore area of the Monviso ophiolitic complex (Italian Western Alps): a record of a subduction-collision cycle? *Ophioliti*, 12, 479–502.
- LEAKE, B.E. (1978): Nomenclature of amphiboles. *Am. Mineral.*, 68, 1023–1052.
- LE MER, O., LAGABRIELLE, Y. and POLINO, R. (1986): Une série sédimentaire détritique liée aux ophiolites piémontaises: analyses lithostratigraphiques, texturales et géochimiques dans le massif de la Crête Mouloun (Haut Queyras, Alpes sud-occidentales, France). *Géol. Alpine*, 62, 63–86.
- LEMOINE, M. and TRICART, P. (1979): Une partie des Schistes et des Ophiolites du Queyras résultent-ils de sédimentation et d'écroulements au pied d'un escarpement de faille océanique? *C.R. Acad. Sci. Paris, (D)* 288, 1655–1658.
- LOMBARDO, B. and POGNANTE, U. (1982): Tectonic implications in the evolution of the Western Alps ophiolite metagabbros. *Ophioliti*, 7, 371–394.
- LOMBARDO, B., NERVO, B., COMPAGNONI, R., MESSIGA, B., KIÉNAST, J.R., MEVEL, C., FIORA, L., PICCARDO, G.B. and LANZA, R. (1978): Osservazioni preliminari sulle ophioliti metamorfiche del Monviso (Alpi occidentali). *Rend. Soc. Ital. Mineral. Petrol.*, 34, 253–305.
- MASSONNE, H.-J. and SCHREYER, W. (1987): Phengite geobarometry based on the limiting assemblage with K-feldspar, phlogopite and quartz. *Contrib. Mineral. Petrol.*, 96, 212–224.
- MEVEL, C. and KIÉNAST, J.R. (1980): Chromian jadeite, phengite, pumpellyite and lawsonite in a high-pressure metamorphosed gabbro from the french Alps. *Mineral. Mag.*, 43, 979–984.
- NITSCH, K.A. (1972): Das P-T-X(CO_2)-Stabilitätsfeld von Lawsonit. *Contrib. Mineral. Petrol.*, 34, 116–134.
- PHILLIPOT, P. (1990): Opposite vergence of nappes and crustal extension in the French-Italian Western Alps. *Tectonics*, 9, 1143–1164.
- PHILLIPOT, P. and KIÉNAST, J.R. (1989): Chemical-microstructural changes in eclogite-facies shear zones (Monviso, Western Alps, North Italy) as indicators of strain history and the mechanism and scale of mass transfer. *Lithos*, 23, 179–200.
- POGNANTE, U. and KIÉNAST, J.R. (1987): Blueschist and eclogitic transformations in Fe-Ti metagabbros: a case study from the western Alps. *J. Petrol.*, 40, 179–200.
- REYNARD, B. and BALLÈVRE, M. (1988): Coexisting amphiboles in an eclogite from the Western Alps: new constraints on the miscibility gap between sodic and calcic amphiboles. *J. metamorphic Geol.*, 6, 333–350.
- SALLOT, P. (1973): Les principales zones de métamorphisme dans les Alpes françaises. Répartition et signification. *C.R. Acad. Sci. Paris, (D)* 276, 3081–3084.
- SALLOT, P., DAL PIAZ, G.V. and FREY, M. (1980): Métamorphisme de haute pression dans les Alpes occidentales. *Géol. alpine*, 56, 203–235.
- SCAILLET, B. (1986): Évolution alpine du domaine océanique piémontais: métamorphisme et tectonique des unités de Schistes lustrés à la bordure nord-ouest du massif du Mont-Viso. D.E.A., Univ. Bretagne occidentale, 56 p.
- SCHAAF, A., POLINO, R. and LAGABRIELLE, Y. (1985):

- Nouvelle découverte de radiolaires d'âge Oxfordien supérieur–Kimméridgien inférieur, à la base d'une série supraophiolitique des Schistes lustrés piémontais (massif de Traversiera, haut val Maira, Italie). *C.R. Acad. Sci. Paris, (II)* 301, 1079–1084.
- STAMPFLI, G.M. and MARTHALER, M. (1990): Divergent and convergent margins in the North-Western Alps: confrontation to actualistic models. *Geodin. Acta*, 4, 159–184.
- STEEN, D.M. (1975): Géologie et métamorphisme du complexe ophiolitique de la Haute-Ubaye (Basses-Alpes, France). *Schweiz. Mineral. Petrogr. Mitt.*, 55, 523–566.
- STEEN, D.M. and BERTRAND, J. (1977): Sur la présence de ferrocapholite associée aux schistes à glaucophane de Haute-Ubaye (Basses-Alpes, France). *Schweiz. Mineral. Petrogr. Mitt.*, 57, 157–168.
- TRICART, P. and LEMOINE, M. (1986): From faulted blocks to megamullions and megaboudins: Terthyan heritage in the structure of the Western Alps. *Tectonics*, 5, 95–118.

Manuscript received March 2, 1993; revised manuscript accepted January 10, 1994.