

A north-south section across the Queyras Schistes lustrés (Piedmont zone, Western Alps) : syn-collision refolding of a subduction wedge

Autor(en): **Tricart, Pierre / Schwartz, Stephane**

Objektyp: **Article**

Zeitschrift: **Eclogae Geologicae Helvetiae**

Band (Jahr): **99 (2006)**

Heft 3

PDF erstellt am: **19.09.2024**

Persistenter Link: <https://doi.org/10.5169/seals-169248>

Nutzungsbedingungen

Die ETH-Bibliothek ist Anbieterin der digitalisierten Zeitschriften. Sie besitzt keine Urheberrechte an den Inhalten der Zeitschriften. Die Rechte liegen in der Regel bei den Herausgebern.

Die auf der Plattform e-periodica veröffentlichten Dokumente stehen für nicht-kommerzielle Zwecke in Lehre und Forschung sowie für die private Nutzung frei zur Verfügung. Einzelne Dateien oder Ausdrucke aus diesem Angebot können zusammen mit diesen Nutzungsbedingungen und den korrekten Herkunftsbezeichnungen weitergegeben werden.

Das Veröffentlichen von Bildern in Print- und Online-Publikationen ist nur mit vorheriger Genehmigung der Rechteinhaber erlaubt. Die systematische Speicherung von Teilen des elektronischen Angebots auf anderen Servern bedarf ebenfalls des schriftlichen Einverständnisses der Rechteinhaber.

Haftungsausschluss

Alle Angaben erfolgen ohne Gewähr für Vollständigkeit oder Richtigkeit. Es wird keine Haftung übernommen für Schäden durch die Verwendung von Informationen aus diesem Online-Angebot oder durch das Fehlen von Informationen. Dies gilt auch für Inhalte Dritter, die über dieses Angebot zugänglich sind.

A north-south section across the Queyras Schistes lustrés (Piedmont zone, Western Alps): Syn-collision refolding of a subduction wedge

PIERRE TRICART¹ & STEPHANE SCHWARTZ²

Key words: Structural geology, accretionary wedge, HP-LT metamorphism, thin-skinned thrusting, post-nappe folding, Piedmont Schistes lustrés, Western Alps.

ABSTRACT

The 10 km thick pile of Queyras Schistes lustrés has a complex structure, resulting from successive deformation phases (D1 to D5). The tectonic history starts with the building of a syn-subduction wedge through accretion of nappes displaying oceanic and distal European margin series. We relate this early wedging to primitive isoclinal folding (D1) associated with blueschist metamorphism in Paleocene-Eocene times. Variations in the P-T conditions allow for distinguishing four early-formed regional-scale tectonic units. During subsequent collision, the wedge continues growing through new shortening phases (D2 to D4) while metamorphism evolves toward greenschist conditions, mainly during Oligocene times. Orogen-perpendicular F2 and F3 folds have opposite facing directions. They still control most of the present-day multiscale structure, which is best visible in an orogen-parallel section. Orogen-parallel F4 folds produce most of the present-day westward dip of the tectonic pile. Their western equivalents in the nearby Briançonnais zone correspond to the classical back-movements. Extension (D5) prevails from the Miocene onwards, resulting in west-dipping detachment faults. The major structures associated with D4 and D5 are also better visible in an orogen-perpendicular section. Special attention is paid to dolomitic and ophiolitic bodies presently scattered amidst the Schistes lustrés structure. They may be of sedimentary or tectonic origin and are again best visible along the proposed orogen-parallel section.

RESUME

Les Schistes lustrés piémontais du Queyras, épais d'une dizaine de kilomètres, présentent une structure complexe, mise en place à la faveur de cinq phases de déformation (D1 à D5). L'histoire tectonique débute en contexte de subduction par l'accrétion à un premier prisme, de nappes pelliculaires provenant de l'océan et de la partie distale de la marge européenne. Nous relierons cette construction à la phase D1, caractérisée par un premier plissement isoclinal associé à un métamorphisme schistes bleus d'âge Paléocène-Eocène. Une évolution dans les conditions P-T de ce métamorphisme HP permet de distinguer quatre unités précoces d'extension régionale. La croissance de ce qui devient un prisme de collision se poursuit au travers de nouvelles phases de raccourcissement (D2 à D4) alors que le métamorphisme évolue du faciès des schistes bleus vers le faciès des schistes verts, essentiellement à l'Oligocène. Les plis F2 et F3, aux vergences opposées, ont leurs axes orientés normalement à l'allongement actuel de la chaîne. Ils commandent toujours l'essentiel de la structure aux différentes échelles, ce qui apparaît le mieux en construisant une coupe longitudinale à la chaîne. Les plis F4 sont parallèles à la chaîne et on leur attribue l'essentiel du pendage ouest actuel de la pile tectonique. En zone briançonnaise, voisine, cette même génération de plis est associée aux rétro-mouvements classiques. Enfin, de l'extension (D5) se développe depuis le Miocène, responsable de failles de détachement à pendage ouest. Ces deux dernières phases se traduisent par des structures mieux visibles suivant une coupe transverse à la chaîne. Par ailleurs, une attention particulière a été accordée aux corps dolomitiques et ophiolitiques disséminés dans la pile des Schistes lustrés. Leur double origine possible, sédimentaire et tectonique, apparaît le mieux suivant la coupe longitudinale proposée.

1. Introduction

The western Alpine arc formed in front of the Apulian-African indenter through subduction-collision processes from the Cretaceous onwards (see Schmid & Kissling 2000 for a review). The present-day structure mainly derives from the Ligurian segment of the Mesozoic Tethys ocean and from its European passive margin (e.g. Lemoine et al. 1986). In the interior of the arc, repeated folding and thrusting of early-

stacked metamorphic nappes result in the complex structure of the Briançonnais and Piedmont internal zones. The external Dauphiné zone exhibits a comparatively simple structure due to little accentuated shortening during a short tectonic history (e.g. Tricart 1984). Here we focus on the Piedmont zone in the central part of the arc (Fig. 1) and, more precisely, on the Piedmont Schistes lustrés complex of the Queyras area, which is located between the Briançonnais zone in the west and the Dora-Maira crystalline massif in the east (Fig. 2). Detailed

¹ Laboratoire de Géodynamique des Chaînes Alpines, Université Joseph Fourier, BP 53, 38041 Grenoble Cedex, France (E-mail: ptricart@ujf-grenoble.fr)

² Laboratoire Interdisciplinaire de Recherche Impliquant la Géologie et la Mécanique, Université Joseph Fourier, BP 53, 38041 Grenoble Cedex, France. (E-mail: Stephane.Schwartz@ujf-grenoble.fr)

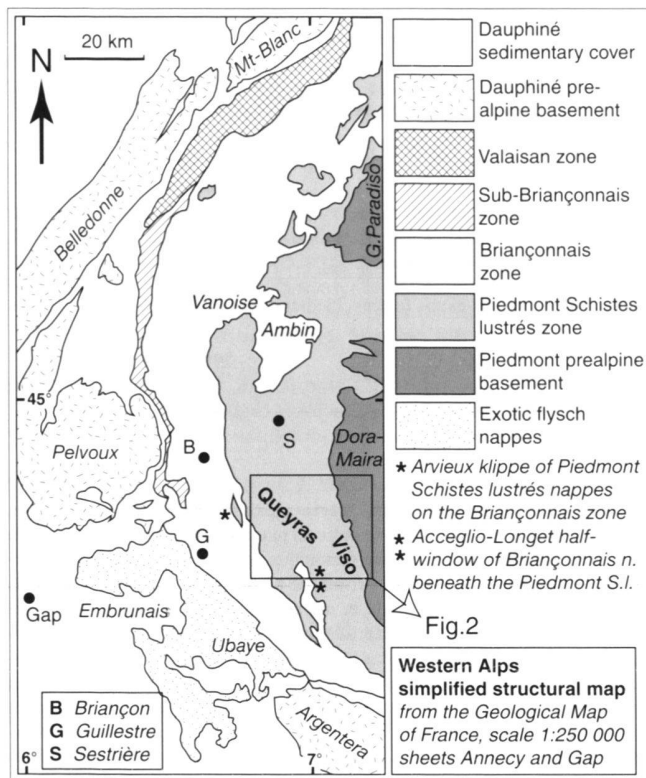

Fig. 1. Simplified structural map of the western Alps and location of Fig. 2.

mapping in the Queyras massifs and their surroundings on both sides of the drainage divide of the range (Barfety et al. 1997; Gidon et al. 1994; Tricart et al. 2003) coupled with structural and metamorphic analysis, has led to a better understanding of the structural complexity and of the corresponding tectonic scenario.

2. The Queyras Schistes lustrés contrasted mountains

The Queyras landscapes are famous for their monotonous cliffs and slopes exposing a huge volume of metamorphosed marl-rich sediments, the so-called Piedmont “Schistes lustrés” (see Lemoine & Tricart 1986 for a review). Bodies of varied, more resistant lithologies such as gabbros, basalts or dolomites seem to be randomly inserted within these soft metasediments. They range in size from less than one meter to a few kilometres. Some of the largest bodies are isolated by erosion and determine steep rocky peaks that contrast with the surrounding gentle-relief mountains. This scattering is partly of sedimentary origin (e.g. Lagabrielle 1987) and partly of tectonic origin. We will put emphasis on the second of these two processes.

3. The main types of Queyras Schistes lustrés series.

Several types of series of Piedmont Schistes lustrés were identified in the Queyras area and its surroundings (Fig. 3, see

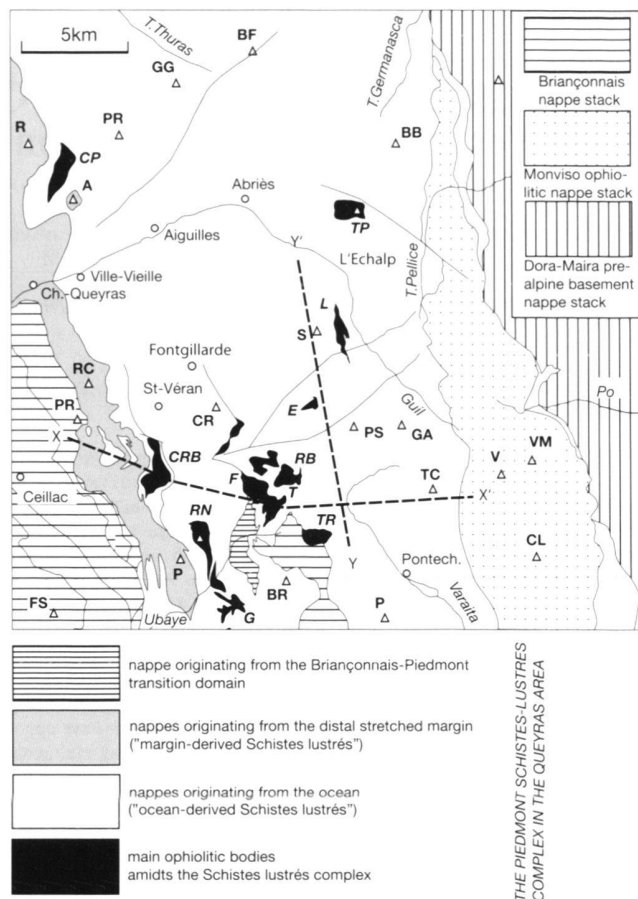

Fig. 2. Structural sketch-map of the Queyras area and its surroundings (modified after Tricart et al. 2003). Main peaks and summits: A: Agrenier; BB: Bric Bouchet; BF: Bric Froid; BR: Bric de Rubren; CL: Cima delle Lobbie; CR: Château-Renard; FS: Font-Sancté; GA: Grande Aiguillette; GG: Grand Glaiza; P: Péouvou; PR: Pointe de Rasis; R: Rochebrune; RC: Roche des Clots; S: Ségure; TC: Tre Chiosis; V: Viso; VM: Viso Mozzo. Main ophiolitic bodies: CRB: Cascavelier-Rocher Blanc; E: Eychassier; F: Farnéiréta; G: La Gavie; L: La Lauze; CP: Col de Péas; RB: Rocca Bianca; RN: Roche Noire; T: Tête des Toillies; TP: Tête du Pelvas; TR: Tour Real. XX' orogen-perpendicular section and YY' orogen-parallel section of Plate 1.

Tricart et al. 2003 for a review). A first type characterizes the nappes derived from the deep continental rift and from its successor, the distal European passive margin (Piedmont domain *sensu stricto*). These nappes were detached within the Carnian evaporites and contain at their base the disrupted remnants of an up to 800m thick sole of Norian dolomites. The overlying succession begins with dated Rhaetian and Early Jurassic beds and ends with marls attributed to the Senonian (e.g., Roche des Clots – Grande Hoche series: Lemoine et al. 1978). Well-developed Lower and Middle Jurassic graded microbreccias (“synrift flysch”) resulted from erosion in the Briançonnais island at a time when this domain represented a raised shoulder in the pre-oceanic Tethyan rift system (Lemoine et al. 1986). Jurassic and Cretaceous marl-rich series globally exhibit a very

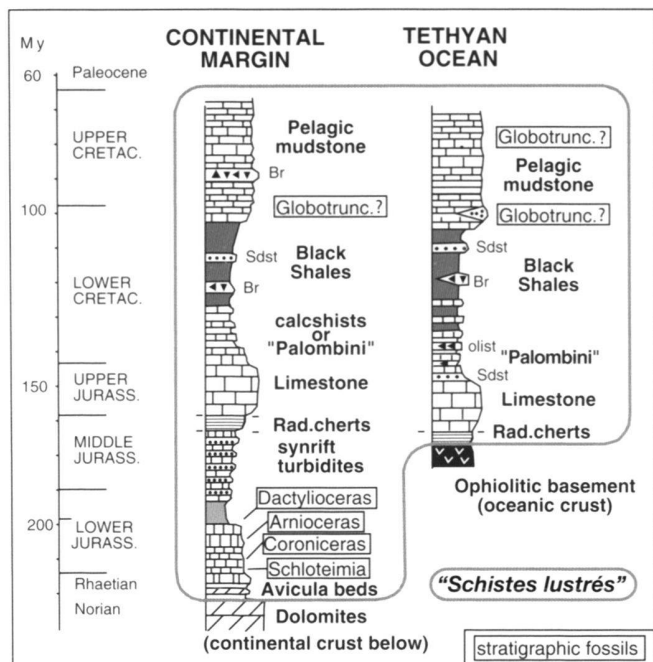

Fig. 3. The two main types of Piedmont Schistes lustrés series in the Queyras (after Lemoine et al. 2000, simplified and modified): continental margin-derived series and Tethyan ocean-derived series. The Upper Jurassic limestones in the ocean-derived series are at the origin of the "marbles" represented in Plate 1.

ductile behaviour, and despite their initial modest thickness (a few hundreds meters) they participate actively to the tectonic thickening that is responsible for the present-day huge volume of the Schistes lustrés complex.

The second type of Schistes lustrés series is derived from the ocean (Ligurian or Ligurian-Piedmont domain *sensu* Lemoine et al. 2000). Metasedimentary series usually start with breccias reworking the ophiolites *in-situ* (e.g., Tricart & Lemoine 1983; see Lagabrielle 1987 for a review). In particular, ophicalcites consist of gravels and blocks of serpentinized peridotites embedded within a calcitic matrix. These breccias are locally associated with pillow basalts and grade upward into discontinuous radiolarian cherts that are locally dated as Mid and Late Jurassic. This laterally variable old ocean floor is overlain by remarkably continuous, 1–10m thick pelagic limestones attributed to the Late Jurassic ("Malm marbles"). Up section, alternating limestones, black-shales and marls are attributed to the Cretaceous (e.g. Lac des Cordes series: Dumont et al. 1984a). In some series, the pelagic sediments enclose giant blocks of ophiolites, up to kilometre-sized, resulting from collapse along intra-oceanic fault-scarps (Lemoine & Tricart 1979). Initially these sedimentary series were only a few hundreds of meters thick, but they are tightly folded and now constitute the main part of the Schistes lustrés tectonic pile in the Queyras area.

Besides margin-derived and ocean-derived series, some re-

constructed peculiar series are attributed to the Tethyan continent-ocean transition domain. Other peculiar series contain chaotic breccias possibly formed at the foot of the major normal fault-scarps that bounded the Briançonnais rift shoulder during the Jurassic and represented the Briançonnais-Piedmont transition domain (Lemoine 1967). All these very disrupted series only occupy a modest volume within the Schistes lustrés structure (see Tricart et al. 2003 for a review).

These different series of Schistes lustrés allow for identifying early thrust-sheets that were stacked before the entire imbricated structure became folded. Ocean-derived series occupy most of the Queyras area while margin-derived series dominate along the western limit of the Piedmont zone, close to the Briançonnais zone (e.g. Rochebrune nappe: Dumont et al. 1984b). A major pinched klippe of this type of nappe is preserved within the Briançonnais zone at Arvieux (see asterisk in Fig. 1; Debelmas & Lemoine 1966). Margin-derived nappes also appear in windows beneath a thick pile of nappes originating from the ocean, to the north of the Queyras in Italy (Sestriere area in the Cottian Alps; Caron 1977). Locally, part of the series originating from the continent-ocean boundary domain may be recognized in the tectonic slivers at the contact between margin-derived nappes and ocean-derived nappes (Cervièrès window: Barféty et al. 1997). In the upper Ubaye valley dismembered series originating from the Briançonnais-Piedmont transition domain are inserted along the main tectonic contact between the Briançonnais and Piedmont zones (Fig. 2; Gidon et al. 1994).

4. Early shallow level thrusting in the ocean

The ophiolites of the Western Alps share most peculiarities with the ophiolites in Corsica or in the Ligurian Apennines (see Tricart & Lemoine 1991 for a review). These peculiarities are attributed to a very slow-spreading ocean, a modern analogue of which is found in the Atlantic or the SW Indian oceans (Lagabrielle & Cannat 1990; Lagabrielle & Lemoine 1997). In the ultramafic massifs of the Queyras and Ubaye area Tricart & Lemoine (1983) demonstrated that the early-formed bottom of the ocean consisted of tectonically denuded mantle peridotites with minor gabbroic intrusions. These peridotites, which were transformed into serpentinite by oceanic hydrothermalism, were widely capped by breccias derived from them (ophicalcites) before localised and limited basaltic volcanic activity started. The sea bottom was carved out by faults that resulted in a rough morphology. This relief controlled the deposition of varied breccias that reworked the serpentinites, gabbros and basalts *in-situ*. The radiolarian cherts represented diachronous and lenticular deposits concentrated in the topographic lows. However, the overlying pelagic calcareous mud draped the entire sea bottom structure, which resulted now in a continuous marker layer (Malm marbles) at the base of the Cretaceous metasedimentary series.

The tectonic contact at the base of the ophiolite-bearing thrust-sheets generally results from a decollement within the

ophicalcite-rich breccias that capped the primitive ultramafic seafloor. Uplifted faulted blocks and localised volcanoes seem to have been truncated along their base. This peculiar type of “scalp” tectonics (Tricart & Lemoine 1988) results in some of the main ophiolitic massifs that are now scattered in the Queyras area and that still retain their primitive sedimentary cover. This process occurred during the closure of the ocean. It explains why the stack of nappes originating from the ocean mainly consists of ocean-derived metasediments (“Schistes lustrés”) with only limited remnants of oceanic basement preserved from place to place at their base.

By contrast, the Viso or Monviso massif located immediately east of the Queyras (Fig. 2) consists of a stack of thick ophiolitic thrust-sheets with well-developed gabbros and basalts, overlain by thin disrupted remnants of oceanic sedimentary cover (Lombardo et al. 1978; see Phillipot 1988 for a review). These ophiolites originate from accretion centres within the ocean, where magmatic accretion relays the initial tectonic mantle denudation as the main ocean spreading process (Lagabrielle & Lemoine 1997). The decollement level was located deeper in the oceanic basement, beneath thick gabbroic intrusions and basaltic flows and at the top of serpentinitized peridotites. According to this interpretation, the variable ophiolite/sediment ratio in the thrust-sheets closely results from the variable depth of the primitive decollement level within the oceanic basement, which is itself controlled by the structure of this basement and the morphology of the sea floor.

5. Regional-scale boudinage

Major remnants of the oceanic basement are scattered within the Schistes lustrés tectonic pile in the form of poorly deformed bodies of ophiolites up to a few kilometres in size. The enclosing metasediments (“Schistes lustrés”) exhibit important ductile deformations. Nevertheless, the primary contact between the ophiolites and their sedimentary cover is generally preserved, even though a dramatic strain gradient may be observed across the basal sediments, close to the contact. Disregarding late thrusts and faults, this sedimentary cover remains continuous from one ophiolitic body to the next, even if they are several kilometres apart. This was interpreted as regional-scale boudinage (“megaboudinage”; Tricart & Lemoine 1986) of the rather thin ophiolitic sole of each nappe within a pile of nappes consisting essentially of ductile ocean-derived metasediments. Moreover, disruption between boudins may have been prepared by the faulted structure of the oceanic basement, in particular where fractures separating basaltic and/or gabbroic blocks were injected by serpentinites (Tricart et al. 1985a, 1985b). In the absence of thick basalts or gabbros, the necking of ophiolites, essentially composed of serpentinitized peridotites, resulted in the development of regional-scale (up to 1 km thick) pinch-and-swell structures, in the core of which intra-oceanic textures (HT foliation, pyroxene layering) are preserved. A comparable scenario was proposed for the nappes derived from the margin. Their sole of Triassic

dolomites also underwent megaboudinage between the underlying evaporites and the overlying Jurassic-Cretaceous ductile sediments. It was locally demonstrated that the synrift (Liasic) faulted blocks in the Triassic series were the precursors of megaboudins (Tricart & Lemoine 1986). When unfolding the final structure, both types of boudins appear to be arranged along strings within which they remain connected by a long thin “peduncle” of schists displaying the characters of a high strain zone. Between the ophiolitic boudins these schists typically derive from serpentinite and ophicalcite. Between the dolomitic boudins, they are everywhere associated with cagneules. Megaboudinage occurred early in the tectonic history during the building of the oceanic accretionary wedge, by stretching within S1 foliation (see section 6) under blueschist facies metamorphic conditions (see section 8). Megaboudinage was certainly accentuated during the ensuing syncollisional growth of the wedge (F2 to F4 folding phases: see section 6) but our structural data do not allow us to directly reconstruct a multistage boudinage history.

6. The multistage folding-thrusting history

Detailed mapping and multiscale structural analysis allow for identifying four main generations of folds and schistosity that we relate to distinct tectonic phases D1 to D4 (see Fig. 4). They predate densely spaced final extensional faulting (D5) that we do not detail in this contribution (see Tricart et al. 2004).

The oldest phase (D1) is represented by widespread recumbent folds (F1). These perfectly isoclinal folds with very sharp hinges are visible at different scales, up to a regional one (see the “sandwich marbles” in Plate 1). The associated schistosity (S1) is a first general foliation developed under blueschist metamorphic conditions (see section 8), at least in the ocean-derived series where this metamorphic facies may be recognized. It was impossible to directly measure fold axes, and due to severe overprinting the main direction of stretching within these folds also remains uncertain. The boudins and pinch-and-swell structures commonly appear within the S1 foliation, partly resulting from stretching within F1 folds, and partly from later reactivations. Considering its style and the relative chronology, we relate this F1 folding phase to the initial stacking of the regional-scale thrust-sheets.

The D2 phase is represented by F2 minor-major folds that display “oak-leaf” geometry or a chevron geometry, depending on the lithological nature of the folded beds. Geometrically, they appear as north-facing recumbent folds with a closed inter-limb angle rather than as perfect isoclinal folds. The S2 schistosity transposed the S1 foliation while the metamorphism evolved from blueschist towards greenschist facies conditions (see section 8). This S2 is reconstructed as a flat-lying schistosity carrying a strong lineation (L2) that parallels the F2 fold axes. This L2 is a stretching lineation that also may represent a mineral lineation or a rod lineation, depending on the lithology. Important accentuation of the boudinage occurred dur-

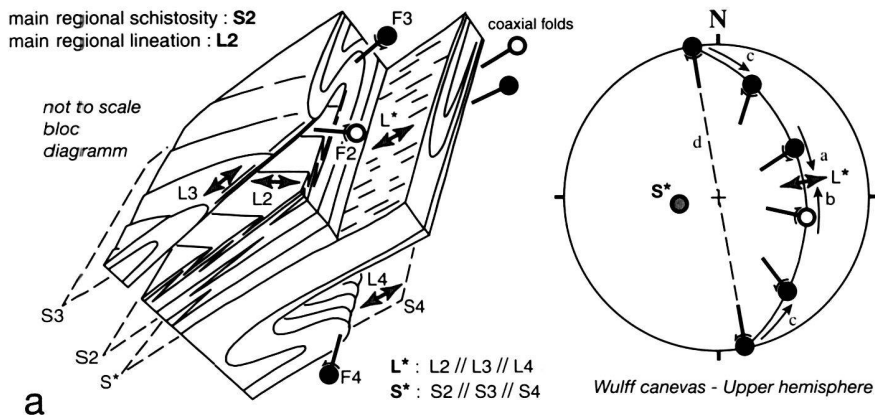
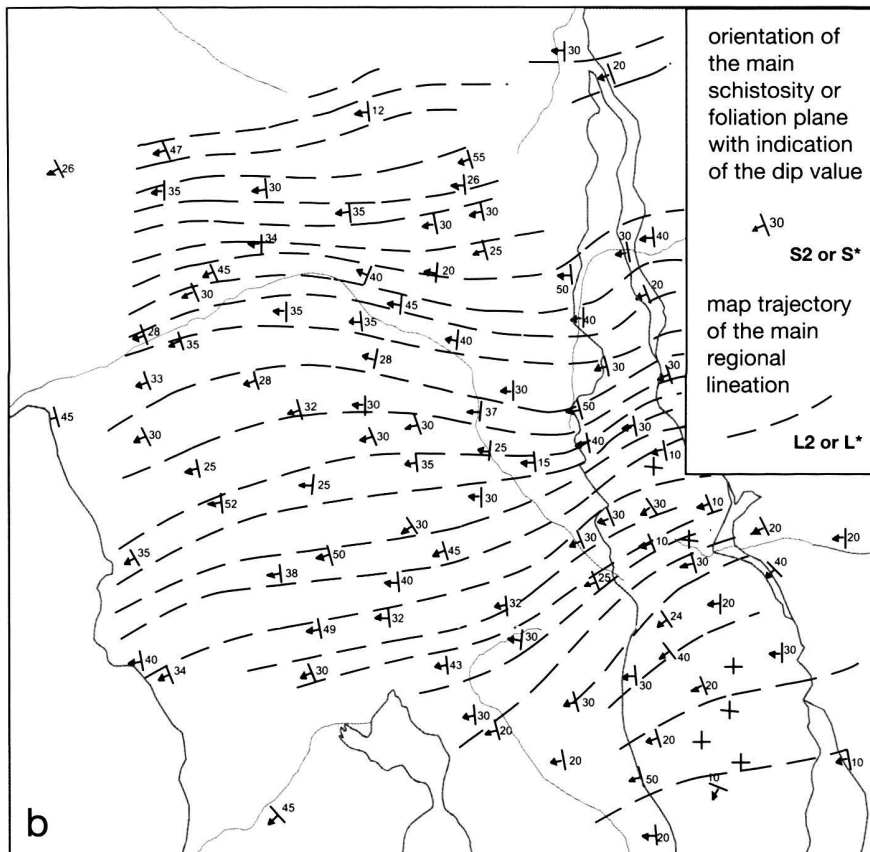

Fig. 4. The isoclinal structure of the Queyras Schistes lustrés. a: synthetic block diagram and stereonet showing the geometrical relationships between the folds (F), schistosity (S) and lineations (L) associated with the successive D2, D3 and D4 deformation phases. For clarity, the original flat-lying S1 foliation and the associated F1 isoclinal folds have been omitted (see "sandwiched marbles" in section YY', Plate 1). As proposed by Hansen (1971), arrows turning around the fold axis symbols indicate the asymmetry patterns of folds in terms of rotation of short limbs relative to long limbs about their hinge lines, the folds being observed down-plunge of the hinge line. The double grey arrows recall the importance of stretching along the successive generations of lineations. The L2 lineation is deformed around the hinge of a F3 fold. Just below, in a zone of accentuated D4 deformation, the earlier formed schistosity become parallel to S4, resulting in a single planar structure S*. The earlier formed stretching L2 and L3 lineations rotate within this plane S* and become parallel to the L4 stretching lineation, resulting in a single very strong stretching lineation L* of composite origin. After a comparable rotation (arrows a and b in the stereonet), the axes of the F2 and F3 folds also become parallel to L* (coaxial folds). Another consequence (not represented in the block diagram) is that the axes of the F4 folds, dominantly small-scale folds, leave their initial N-S horizontal orientation and start rotating (arrows c in the stereonet) within S4 toward the L4 direction of stretching, resulting in axes with a planar dispersion and hinges with a non-cylindrical geometry. In the stereonet, the dashed line (d) represents the projection of the plane of the section YY' (Plate 1). b: regional orientation of the dominant schistosity and lineation (same structural sketch map as in Fig. 2).



ing this D2 phase. These F2 fold axes were reconstructed to have been originally oriented close to WNW-ESE in Eastern Queyras and close to NW-SE in western Queyras (Caron 1977; Tricart 1980). Presently, these F2 folds remain most visible everywhere in the Queyras area, and S2/L2 represents such a prominent regional schistosity/lineation pair that it is often difficult to detect the existence of earlier structures (see discussion in Caron 1977).

The D3 phase is represented by folds (F3) that display a variable open to closed, almost isoclinal geometry with dominant rounded hinges. Beside widespread isolated folds, tight

folding only develops from place to place. The F3 fold axes generally trend WSW-ESE and are reconstructed as being originally oriented close to this direction. The associated schistosity (S3) is underlined by recrystallized greenschist minerals. Originally S3 was subhorizontal or gently north-dipping. The associated stretching direction is generally parallel to the fold axes. Nevertheless, locally, the D3 phase ends with small top-south thrusting (e.g., Rocca Bianca - Caramantran massif in upper Aigue Blanche valley). There, F3 folds become strongly asymmetrical and the stretching direction become oriented close to N-S.

The fourth phase (D4) is represented by folds that generally retained their original N-S to NW-SE orientation (main direction NNW-SSE). They parallel the general trend of the mountain belt, which contrasts with the two previous generations of orogen-perpendicular folds. The associated schistosity (S4) is a strain-slip cleavage within which some greenschist minerals crystallize. This schistosity dips variably westward and contains a direction of stretching that trends ENE-WSW. In the more deformed areas, earlier-formed lineations, especially L2, tend to become parallel with this new direction of stretching (Fig.4). Another consequence of this stretching is that small-scale hinges of F4 folds may be curved while others rotate, resulting in an important planar dispersion of the measured axes (e.g., Tricart 1975; Caron 1977). In the western Queyras, tight major to minor F4 folding is closely associated with the reversal of the westernmost Piedmont Schistes lustrés toward the east, i.e. to backfolding (Tricart 1975; see section 10). In eastern Queyras, F4 folds are essentially asymmetrical minor folds, and the dominant asymmetry is of “reverse limb” type (Schwartz 2002). Our F3 and F4 folds were believed to belong to the same tectonic phase by Caron (1977), which is not confirmed here.

In some contrasting lithologies the last folding phase (D4) is followed by small-scale boudinage within the main foliation plane (S2 variably transposed into S3 or S4) along two directions, normal and parallel to the mountain belt. The resulting chocolate tablet structure illustrates the ductile to brittle transition while the tectonic regime evolves into a multidirectional, almost radial extension (Schwartz 2002). This boudinage is followed by widespread normal faulting (D5 phase) also oriented normal and parallel to the mountain belt, indicating that multidirectional extension continues under purely brittle conditions (Schwartz 2002). In the eastern Queyras faulting accompanies the general tilting of the Schistes lustrés pile toward the west (Tricart et al. 2004). Present-day seismicity indicates that this normal faulting remains active (Sue & Tricart 2003).

This succession of ductile and finally brittle deformation phases (D1 – D5) is common to all Piedmont Schistes lustrés nappes in the Queyras area, regardless of whether they originate from the margin or the ocean.

7. Late Jurassic bands of “sandwiched marbles”

In the Queyras area isolated bands of white or light-grey marbles, a few meters to several tens of meters thick, are repeatedly seen to run within the bulk mass of calcschists. They were either interpreted as original sedimentary alternations within the Cretaceous calcschists (see for example Lagabrielle 1987) or as tectonic derivatives of the Late Jurassic (Malm) marbles (Lemoine & Tricart 1993). Based on detailed mapping of the entire area we will confirm and precise the second interpretation.

These marbles are typically inserted amidst the Early Cretaceous formations that are represented by alternating brown siliceous limestones and black shales or by dark-grey

calcschists. They may be followed over great distances across the Schistes lustrés structure in the Queyras and surrounding areas. At a closer look, each marble band exhibits an internal “sandwich” structure. Typically, two twin marble layers derived from calcareous layers with opposite polarities are separated by a film of asbestos- and talc-rich chlorite schists derived from tectonised serpentinite or ophicalcite. This continuous film is difficult to detect where it is only a few centimetres thick and results in a discrete recessive at mid level in marble cliffs. Nevertheless, from place to place, it swells into lenses and bodies of basalt, gabbro and serpentinite, usually of metric to decametric size, but more locally up to a kilometric size.

This film of chlorite schists bears witness of an early decollement along the original boundary between (i) the ophiolites and derived breccias and (ii) their pelagic sedimentary cover, mainly represented by the Late Jurassic limestones. From place to place, this is confirmed by the occurrence of radiolarian cherts inserted between the chlorite schists and the marbles in their original stratigraphic position. The systematically observed symmetry results from perfectly isoclinal folding. Due to an extreme amplitude and the comparatively short wavelength each band of these “sandwiched marbles” represents the two limbs of a particular fold. In the hinge zone the marbles gradually thin out amidst the calcschists, and along the S1 foliation. The sharpness of these hinges prevents their orientation to be measured. Close stacking of hinges explains that, locally, the apparent thickness of the marbles reaches several hundreds meters while laterally they may be very attenuated, only one meter thick or less. Beside these peculiar sandwiched marble bands, sedimentary recurrences of light-grey limestones within the Early Cretaceous calcschists have been recognized but they remain poorly developed (Tricart et al. 1982).

We interpret the alternating sandwiched marbles and Early Cretaceous calcschists as piles of regional-scale recumbent fold limbs. In the regional chronology they represent early folds (F1) associated with the general blueschist foliation (S1). This pile is clearly deformed by the north-vergent folds (F2). These Malm marbles illustrate the extreme ductility of the “Schistes lustrés” and bear witness of an early stage of formation of the Queyras wedge. Moreover, they provide a key to understanding the regional-scale structure (see section 9, Plate 1 and Fig. 5).

8. The metamorphic structure of the blueschist-bearing wedge

Along the Queyras transect, as in the rest of Alpine arc, the internal zones display a HP-LT metamorphic imprint attributed to rapid tectonic burial of cold thrust-sheets in subduction dynamics (Oberhänsli et al. 2004; Goffé et al. 2004). In the west, at the front of these internal zones, HP greenschist facies conditions (B in Fig. 6a) were reported in the Briançonnais zone (Goffé & Velde 1984; Goffé et al. 2004). Eastward, blueschist facies conditions in the Queyras Schistes lustrés (e.g. Caron 1979) and eclogite facies conditions (V in Fig. 6a) in the Viso

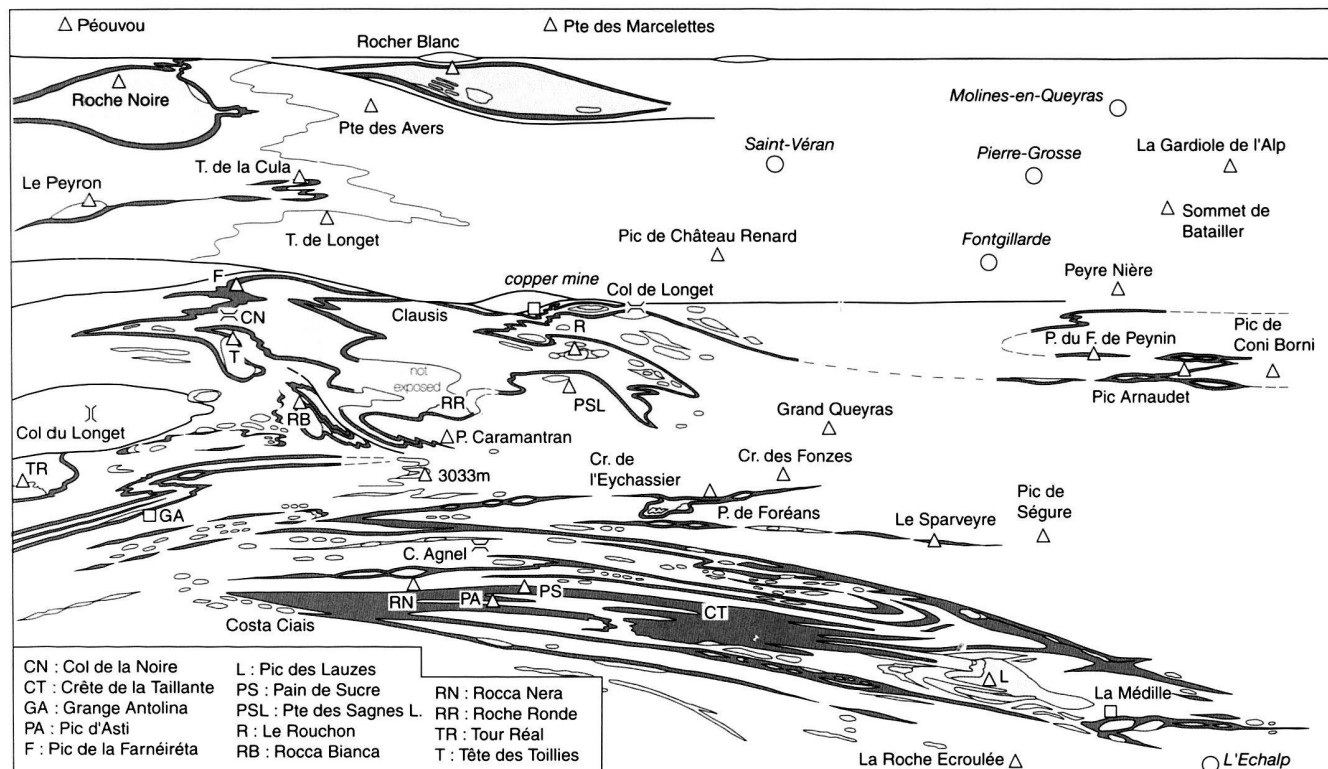

Fig. 5. Names of the geographic landmarks figured in section YY' (plate 1), according to the topographic map from the French Institut Geographic National (IGN), scale 1:25 000.

ophiolites (Lombardo et al. 1978; see Schwartz et al. 2000a for a review) correspond to a general increase of the P-T conditions from top to bottom across the tectonic pile (Schwartz 2002), also observed in the Cottian Alps just to the north (Agard et al. 2001). Nevertheless, this increase does not extend farther east and down in the Dora-Maira crystalline basement nappe stack taken as a whole, since varied HP to UHP metamorphic facies conditions (D in Fig. 6a) were reported in different units (e.g., Michard et al. 1993). South of the Queyras area, in the Acceglio-Longnet half-window beneath the Piedmont Schistes lustrés, the most internal Briançonnais series ("Ultra-Briançonnais" series) display HT blueschist facies metamorphic assemblages (AL in Fig. 6a; Lefèvre & Michard 1965; Schwartz et al. 2000b).

The petrographic analysis of the Queyras meta-ophiolites leads to the distinction of four metamorphic units (I – IV in Fig. 6a) with distinct P-T paths. These regional-scale units are roughly exposed as orogen-parallel bands that are a few kilometres wide, but due to subsequent refolding their boundaries are not easy to precisely follow everywhere. We describe them from west to east, i.e. from top to bottom, across the structure.

Metamorphic unit I. In this upper unit, the stable mineralogical assemblage of glaucophane, lawsonite and jadeite allows for estimating $T < 350^\circ\text{C}$ and $8 < P < 11$ kbars (Caby 1996; Schwartz 2002). These conditions are compatible with the

presence of fresh carpholite in the calcschists and with a Si^{4+} phengitic substitution rate between 3.20 and 3.45 p.f.s (Agard 1999; Goffé et al. 2004). This corresponds to LT blueschist facies metamorphism.

Metamorphic unit II. The stable assemblage of glaucophane, lawsonite and albite and the absence of jadeite in the mafic rocks allowed Schwartz (2002) for estimating a maximum temperature of 400°C at the same pressures as in metamorphic unit I.

Metamorphic unit III. The stable assemblage of albite, zoisite and glaucophane, and the absence of lawsonite and jadeite in mafic rocks allowed Schwartz (2002) for estimating $400 < T < 450^\circ\text{C}$ and $9 < P < 11$ kbars.

Metamorphic unit IV. In this eastern and lower unit the stable assemblage of jadeite, zoisite, glaucophane, omphacite and paragonite, the absence of almandite rich-garnet in mafic rocks and the content of jadeite (X_{jd}) in omphacites which varies from 0.33 to 0.55, allowed Schwartz (2002) for estimating $400 < T < 475^\circ\text{C}$ and $11 < P < 14$ kbars. These conditions are consistent with the observed chloritoid-phengite co-stability in the metasediments associated with mafic rocks (Goffé et al. 2004). These conditions are typical for the blueschist-eclogite transitional facies.

In summary, the metamorphic P-T conditions in the Queyras Schistes lustrés increase regionally toward the east,

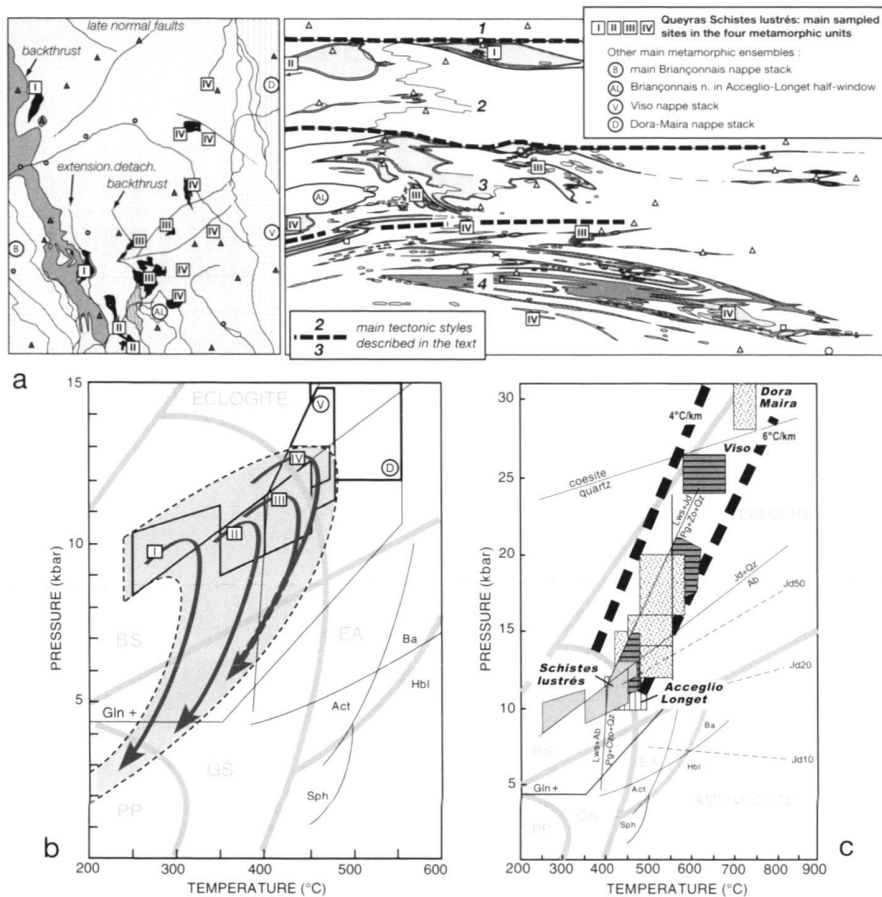

Fig. 6. The four main blueschist-bearing early-formed units of Queyras Schistes lustrés in their regional metamorphic context. a: Sketch map (see Fig. 2) and N-S section (see YY' in Plate 1) with location of the main sampled ophiolites. 1 to 4: main tectonic styles described in the text. b: The main metamorphic assemblages observed in the mafic rocks and their P-T conditions of formation and retro-morphic evolution. The eclogitic conditions in the Viso ophiolites (Schwartz et al. 2000a) and the Dora-Maira massif (Michard et al. 1993) are indicated for comparison. Metamorphic facies is from Spear (1993) with: PP, prehnite-pumpellyite; GS, greenschist; BS, blueschist; EA, epidote amphibolite; AM, amphibolite. The stability of glaucophane (Maresch 1977), lawsonite (Heinrich & Althaus 1988), coesite (Bohlen & Boettcher 1982), titanite (Moody et al. 1983) and calcosodic-amphibole (Ernst 1979), the reaction $Jd+Qz = Ab$ (Holland 1980) and the jadeite isopleths (Gasparik & Lindsley 1980) are indicated. c: Compilation of HP-LT conditions available along the same Alpine transect in the Queyras – Viso units (Nisio & Lardeaux 1987; Messiga et al. 1999; Schwartz et al. 2000a) and the Dora-Maira units (Chopin et al. 1991; Michard et al. 1993).

from LT blueschist conditions up to the conditions of the blueschist-eclogite transition and consistently, further to the east, all the metamorphic assemblages are eclogitic (V in Fig. 6). This blueschist metamorphism in the Queyras area is attributed to accretion at the base of an oceanic crustal wedge, at 30–40 km depth, coeval with our D1 deformation phase. The small jumps in the P-T conditions between metamorphic units are consistent with their successive accretion to the oceanic wedge as independent tectonic slivers. The resulting regional-scale zoning is the best witness of this early wedging stage in the present-day structure. Everywhere in the Queyras ophiolites the retro-morphic evolution remains within the field of the chlorite-actinote-albite paragenesis (greenschist facies) without any temperature increase while the D2 to D4 sequence of deformation took place. The corresponding P-T paths exhibit clockwise loops (Fig. 6b). These paths are regionally coherent in all units (Schwartz 2002) including their northern extension in Italy (Agard et al. 2002). Due to unfavourable lithological compositions, the P-T conditions during peak metamorphism could not be accurately determined in the margin-derived Schistes lustrés units (1 in Fig. 6a) that only display retro-morphic greenschist facies assemblages.

9. A general section oriented parallel to the mountain belt: the importance of E-W trending folds

F4 submeridian folding, particularly prominent in the west, and ensuing syn-faulting westward tilting, particularly prominent in the east, both result in a present-day westward dip of the entire Schistes lustrés pile of the Queyras area (Plate 1: orogen-perpendicular XX' section). This pile represents an isoclinal structure, within which bedding parallels the S1 foliation, the S2 schistosity and, more locally, the S3 and S4 schistositities (Fig. 4). Within these planes, the main regional lineation plunges toward the WSW nearly everywhere (Fig. 4). This essentially results from the reorientation of L2 toward the new direction of stretching (L4). This lineation roughly parallels the direction of the F2 and F3 folds, which are nearly coaxial and plunge toward WSW. In consequence, the best section plane to allow for representing the regional folded structure is oriented NNW-SSE (N170°E), roughly normal to the trend of the F2 and F3 axes. Section YY' (Plate 1) was constructed by directly projecting the mapped beds onto this plane. The direction of projection is the main direction of the regional stretching lineation, close to the axial direction of most F2 and F3 folds, i.e. N80°E with a plunge of 30° toward SSW. Because

the structures also evolve along the W-E direction (non-cylindrical structures) and because the beds are projected from a variable distance, the section cannot provide an « exact » geometry. Nevertheless, it allows for evocating the structural style and its regional-scale variations. For that purpose, the main effects of late normal faulting have been removed. The major submeridian F4 folds (western Queyras, upper part of the section) that trend nearly parallel to the plane of the section are not represented.

The geometry of the structures evolves across the entire Schistes lustrés pile, which is best visible along the orogen-parallel section (YY' in Plate 1). From west to east i.e. from top to bottom in the pile, four main sets of structures may be distinguished (labelled 1 to 4 in Fig. 6a), each of them exhibiting its proper tectonic style. These sets appear to be partly independent from the four metamorphic units defined in the previous section on the basis of the peak metamorphism conditions. We explain this discrepancy by the polystage character of the tectonic evolution.

- (1) *Megaboudins*. Beneath the backthrust eastern Briançonnais zone, a first set of structures corresponds to the westernmost Schistes lustrés (e.g., T. de la Jacquette and S. Jacquette in section XX'). This tectonic style is dominated by the regional-scale boudinage of Triassic dolomites in well-developed passive margin-derived series. A string of gabbroic and basaltic boudins also develops in ocean-derived series. These “mega-boudins” already described by Tricart & Lemoine (1986) were not projected onto section YY' because the F4 orogen-parallel folds are too important. Eastward in the map and downward in the section, this first set of structures is limited by a west-dipping backthrust (D4 event), the surface of which is projected onto section YY' as a horizontal line.
- (2) *Pinch-and-swell structures*. A different tectonic style is illustrated by the geometry of the major ophiolite bodies, Roche Noire and Cascavelier – Rocher Blanc (labelled “CRB” in the sections), which mainly consist of serpentinites with minor gabbros and basalts. They represent the boudinaged core of a major recumbent F1 fold. Above and beneath, the sedimentary cover of these serpentinites represents the two opposite limbs of the F1 fold. Regional-scale inhomogeneous stretching and necking results in regional-scale pinch-and-swell structures. These twin ophiolitic massifs are separated by a west-dipping extensional detachment related to the late ductile to brittle extension (D5 event). This may explain the observed small jump in metamorphic conditions (compare I and II in Fig. 6). E-W trending folds gently overprint these pinch-and-swell structures with rounded hinges. Eastward in the map and downward in the section, this second set of structures is limited by a west-dipping east-directed backthrust, associated with F4 folds. A major tectonic sliver with giant fault-scarp breccias originating from the Briançonnais-Piedmont transition domain (Fig. 2) is inserted at this contact.

- (3) *Folded pinch-and-swell structures*. The third tectonic style is associated with a more complicated general structure resulting from the development of E-W trending south-vergent folds coeval with small south-directed thrusts (D3 event). They overprint a structure that is comparable to the early structure partly preserved in the Roche-Noire and Rocher Blanc massifs. This overprint results in the interfingered geometry of the ophiolitic bodies, which consist of serpentinites (Pic de la Farnareita: F in both sections) with minor gabbros (Rocca Bianca: RB in Fig. 5) and basalts (Tête des Toillies: T in both sections). In addition, and contrary to the Roche Noire and Rocher Blanc massifs, the Cretaceous metasedimentary cover of the ophiolites contains scattered ophiolitic blocks of varied size that should not be confused with the boudinaged remnants of the ophiolitic substratum at the base of these series. A good example of such a giant block is Le Rouchon summit (R in Fig. 5). This third set of structures mainly derives from the refolding of the early metamorphic unit III (see Fig. 6). Beneath it, in the south, appears the northern end of the Acceglio-Longet band of easternmost Briançonnais nappes (“ultra-Briançonnais” half-window, ** in Fig. 2) that may represent an F2 fold hinge. It has its own metamorphic history (AL in Fig. 6).
- (4) *Isoclinal polystage folds*. At the bottom of the Queyras structure, lies a spectacular pile of E-W trending folds affecting the particularly well-developed Malm sandwiched marbles. These marbles are most deformed, and their apparent thickness may exceptionally reach a few hundreds of meters in the Crête de la Taillante massif (CT in Fig. 5). Due to the shallower decollement in the oceanic series and the stronger alpine stretching, the old ophiolitic substratum is only represented in small and very disrupted serpentinitic, gabbroic and basaltic bodies. An exception is the Pic des Lauze ophiolitic massif (L in Fig. 5) with tightly folded pillowed basalts, which are a few hundreds meters thick. The most visible folds are closed chevron folds (F2). A good example of kilometric-scale hinge is visible to the south of the Costa Ciais (***) in both sections of plate 1). Refolded hinges indicate the superimposition of coaxial folds (F3). Many sharp lateral extremities of sandwiched marbles bands, such as to the north of the small Crête de l'Eychassier ophiolites (gabbroic dike complex within serpentinite, location Fig. 5), represent the hinges of F1 intrafolial recumbent folds. As in the overlying set, numerous ophiolitic olistoliths are imbedded within the Cretaceous pelagic series, but they are more flattened and stretched. This fourth set mainly derives from the early metamorphic unit IV (see Fig. 6). The upward convex bend of the entire folded structure along section YY' is an artifact, resulting from the global curvature of the structure in map view. Beneath this fourth set, and not represented in section YY', lies the stack of ophiolitic thrust-sheets, up to 5 km thick, that composes the Viso massif, where the ophiolite/metasediment ratio is inverted with respect to the

Queyras. It has its own metamorphic history (V in Fig. 6). Further down lies the pre-alpine basement nappe stack of the Dora-Maira massif that is now exposed in the core of the arc with a yet different metamorphic history (D in Fig. 6).

In summary, the tectonic style dramatically evolves across the nearly 10km-thick Schistes lustrés pile in the Queyras area. This evolution is much better visible in a N-S section than in an E-W section, which explains why it has not been described up to now. From top to bottom across the structure, more flattened and stretched ophiolites and more intense folding are globally consistent with the increasing grade of metamorphism documented in the previous section. The general structure we describe here in the Queyras Schistes lustrés sensibly differs from the structure proposed by Lagabrielle & Polino (1987, 1988) in terms of the number and limits of the main tectonic units.

10. The regional tectonic scenario in the Alpine context

During the Paleogene, the building of an accretionary wedge is related to subduction, successively affecting the oceanic domain and the most stretched part of the European margin. Among the numerous K-Ar radiometric ages available in the Queyras Schistes lustrés (Takeshita et al. 1994), those between 60 and 54 My (Paleocene) may be related to the blueschist facies metamorphic crystallisations accompanying the primitive accretion within the oceanic wedge (Schwartz 2002). This age is consistent with the minimum age of 55 My proposed for the same metamorphic event by Agard et al. (2002) in the Cottian Alps further north. It is also consistent with the Late Cretaceous age proposed for the younger sediments in the Queyras (Fig. 3; Lemoine et al. 1984). Just to the east, in the Viso eclogitic ophiolites, radiometric ages at around 50 My indicate that deep subduction was active during the Early Eocene (Duchêne et al. 1997). Concurrently, the growth of the Queyras wedge is supposed to have continued. However, our data do not allow for detailing early deformation events within what we here define as the initial tectonic phase (D1). In the Briançonnais domain just west of the Queyras, the syntectonic deposition of the “Flysch Noir” (Debelmas et al. 1988) records the growth of the wedge during the Lutetian and Bartonian. Cessation of sedimentation in the Briançonnais domain during the Priabonian is explained by the accretion of the Briançonnais nappes to the wedge. In the Queyras Schistes lustrés no field observation allows us for proposing a direction of thrusting. However, in an overall Alpine context, this direction is likely to be toward the north or the NW (Schmid & Kissling 2000; Ceriani et al. 2001; Bucher et al. 2003 and 2004; Ceriani & Schmid 2004).

After the Eocene, during the development of collision, the external arc of the Western Alps is progressively tectonized. Concurrently, in the internal arc, several new contractions occur within the nappe stack, followed by the onset of an ex-

tensional tectonic regime (e.g., Sue & Tricart 2002). Our post-nappe folding phases (D2 to D4) in the Queyras were formed in this context. To the east, E-W trending folds were initially described within the Dora-Maira massif by Vialon (1966), who considered a single “transverse” folding phase. In fact, according to Mawhin et al. (1983), the north-facing folds concentrate in the central and southern part of the massif (e.g., Val Lucerna) and predate the south-vergent folds such as those visible in the northern part of the massif (e.g., Val Susa). We compare them to our F2 and F3 folds respectively. West of the Queyras, our F2 and F3 folds extend into the Briançonnais zone but their axial direction exhibits an arcuate regional pattern, and due to very different lithologies, the tectonic style also dramatically changes (Tricart 1986). The last folding phase in the Queyras (orogen-parallel F4 folds) is better developed in the western Queyras. This phase is in fact most developed in the Briançonnais zone and extends westward into the internal-most fringe of the external zone. In all the internal zones, this phase clearly represents the last alpine contraction, resulting in east-vergent post-nappe folds and east-directed thrusts i.e. to the so-called backfolds and backthrusts (see also Bucher et al. 2003). Even if alternative interpretations were proposed (e.g., Caby 1996), this phase is responsible for the major backfold (“pli en retour” of the French geologists) that separates the overturned internal Briançonnais nappe stack (eastern side of the Briançonnais fan) from the rest of the Briançonnais zone (see Tricart & Sue 2006 for a review).

The post-nappe folds are not directly dated in the Queyras Schistes lustrés, and the correspondence with the polystage structures dated further north in the Schistes lustrés of the Cottian Alps by Agard et al. (2002) remains to be documented since clear superimposition of four generations of folds and associated schistosity are not reported by these authors. Nevertheless, bracketing allows us for proposing an Oligocene age for the F2 to F4 folding sequence. Indeed, fission-track analyses in zircon and apatites show that the final exhumation of the Queyras Schistes lustrés to upper crustal conditions widely occurred in Miocene times (Schwartz 2002). The associated brittle deformation is related to an ongoing extensional tectonic regime affecting the entire Queyras-Briançonnais wedge (Sue & Tricart 2003). Our D5 event represents this extension.

11. Conclusions

The huge volume of apparently monotonous calcschist-rich series exposed in the Queyras mountains does not derive from thick deep-sea sedimentation (« Schistes lustrés trough ») but mainly results from tectonic thickening through two distinct processes: (1) stacking of thin-skinned nappes (D1 phase) during the Paleocene-Eocene under blueschist facies metamorphic conditions, associated with the formation of a syn-subduction wedge, and (2) repeated folding of the nappe stack (D2 to D4 phases) during the Oligocene when metamorphism evolved from blueschist to greenschist facies conditions, associated with the growth of what has become a syncollision wedge. D4,

the last phase of contraction, is responsible for the general N-S trend of the presently exposed structures. From the Miocene onwards these structures were exhumed under brittle conditions, and an extensional regime prevailed (D5 phase, not detailed here).

The general structure of the Piedmont Schistes lustrés has been poorly investigated by earlier studies because of the monotonous calcschist-rich series, which were believed to be stratigraphically undecipherable. The peculiar style that we describe in the ocean-derived “Schistes lustrés” in fact results from a conjunction of the following factors:

- Thin-skinned thrusting, resulting from shallow-level decollement in the ocean (“scalp tectonics”) along the widespread serpentinite-derived breccias that characterize this very low spreading ocean.
- Regional-scale boudinage (“mega-boudinage”) of the thin ophiolitic sole of the thrust-sheets during early stacking and folding, favoured by the density of faults in the oceanic basement and the ductility contrast between mafic and ultramafic rocks.
- Intense multistage refolding of the nappe stack under blueschist to greenschist facies conditions allowing for the calcschist-rich series to remain remarkably ductile.

The scattering of ophiolitic bodies of varied size across the Queyras Schistes-lustré pile could evoke the impression of a tectonic melange, similar to those forming in subduction zones. In fact, isolated ophiolitic bodies may have different origins: (1) tectonic boudins derived from the detached oceanic substratum of the Schistes lustrés series, in the core of early recumbent folds; (2) olistoliths still enclosed within their hosts sediments and bearing witness of fault-scarp collapse during ocean spreading; (3) tectonic lenses inserted within thrust surfaces and derived from either boudins or olistoliths.

But for the “scalp tectonics”, inherent to an oceanic origin, a comparable scenario may be reconstructed. It involves with early thin-skinned thrusting and megaboudinage, followed by repeated folding of the entire nappe stack in the part of the Queyras wedge which derives from the distal European margin and which was not detailed in this study (1 in Fig.5).

The formation of the Queyras Schistes lustrés complex starts with the stacking of ocean- and distal margin-derived thrust-sheets in an active margin context. This early structure was essentially reconstructed through the analysis of the associated HP-LT metamorphism, allowing for the identification of different units that followed slightly different P-T paths. The presently exposed structure essentially results from severe and repeated refolding of the early accretionary wedge during continental collision. The complexity of this structure may be explained by the ductility contrast between calcschist-rich series, Triassic dolomites associated with evaporites, and the basalts and gabbros associated with serpentinites. This complexity is best visible when observing the structures along a section oriented parallel to the belt since the dominant fold system is now oriented normal to this belt.

Acknowledgements

Many thanks are due to Romain Bousquet, Stefan Bucher and Stefan Schmid who greatly helped in refining both the content and language of this paper.

REFERENCES

- AGARD, P. 1999: Evolution métamorphique et structurale des métapélites dans l'orogène alpin: exemple des Schistes lustrés des Alpes occidentales (Alpes cottiennes). Unpublished thesis, University of Paris 6, 278 pp.
- AGARD, P., JOLIVET, L. & GOFFÉ, B. 2001: Tectonometamorphic evolution of the Schistes lustrés complex: implication for the exhumation of HP and UHP rocks in the Western Alps. *Bull. Soc. géol. France* 172, 617–636.
- AGARD, P., MONIE, P., JOLIVET, L. & GOFFÉ, B. 2002: Exhumation of the Schistes Lustrés complex: in situ laser probe Ar-40/Ar-39 constraints and implications for the Western Alps. *J. metam. Geol.* 20, 599–618.
- BARFETY, J. C., LEMOINE, M., DE GRACIANSKY, P. C., TRICART, P. & MERCIER, D. 1997: Carte géologique de France (1/50 000) feuille Briançon (823). *Bur. Rech. Géol. Min. Orléans*.
- BOHLEN, S. R. & BOETTCHER, A. L. 1982: The quartz-coesite transformation: a precise determination and the effects of other components. *J. Geophys. Res.* 87, 7078–7083.
- BUCHER, S., SCHMID, S. M., BOUSQUET, R. & FÜGENSCHUH, B. 2003: Late-stage deformation in a collisional orogen (Western Alps): nappe refolding, backthrusting or normal faulting? *Terra Nova* 15, 109–117.
- BUCHER, S., ULARDIC, C., BOUSQUET, R., CERIANI, S., FÜGENSCHUH, B., GOUFFON, Y. & SCHMID, S. M. 2004: Tectonic evolution of the Briançonnais units along a transect (ECORS-CROP) through the Italian-French Western Alps. *Eclogae geol. Helv.* 97, 321–345.
- CABY, R. 1996: Low angle extrusion of high-pressure rocks and the balance between outward and inward displacements of middle penninic units in the western Alps. *Eclogae geol. Helv.* 89, 229–267.
- CARON, J. M. 1977: Lithostratigraphie et tectonique des Schistes lustrés dans les Alpes cottiennes septentrionales et en Corse orientale. *Mém. Sci. géol. Strasbourg* 48, 326p.
- 1979: Relation entre métamorphisme et déformation dans les Alpes cottiennes. *Eclogae geol. Helv.* 72, 497–507.
- CERIANI, S., FÜGENSCHUH, B. & SCHMID, S. M. 2001: Multi-stage thrusting at the « Penninic Front » in the Western Alps between Mont-Blanc and Pelvoux massifs. *Int. J. Earth Sciences* 90, 685–702.
- CERIANI, S. & SCHMID, S. M. 2004: From N-S collision to WNW-directed post-collisional thrusting and folding: structural study of the Frontal Penninic Units in Savoie (Western Alps, France). *Eclogae geol. Helv.* 97, 347–369.
- CHOPIN, C., HENRY, C. & MICHARD, A. 1991: Geology and Petrology of the coesite bearing terrain, Dora Maira massif, Western Alps. *Europ. J. Mineral.* 3, 263–291.
- DEBELMAS, J. & LEMOINE, M. 1966: Carte géologique de France (1/50 000), feuille Guillestre (847). Service de la Carte géologique de France Paris.
- DEBELMAS, J., KERCKHOVE, C. & DESMONS, J. 1988: Sur l'âge de la phase méso-alpine dans les zones internes des Alpes franco-italiennes. *C. R. Acad. Sci., Paris sér. II* 306, 1237–1240.
- DUCHENE, S., Blichert-Toft, J., LUIS, B., TÉLOUK, P., LARDEAUX, J. M. & ALBARÈDE, F. 1997: The Lu-Hf dating of garnets and the ages of the Alpine high-pressure metamorphism. *Nature* 387, 586–589.
- DUMONT, T., LEMOINE, M. & TRICART, P. 1984a: Périodicité de la sédimentation pélagique du Jurassique supérieur jusque dans le Crétacé supérieur au dessus de la croûte océanique téthysienne ligurienne: la série supra-ophiolitique du lac des Cordes (zone piémontaise des Alpes occidentales au SE de Briançon). *C. R. Acad. Sci., Paris sér. II* 15, 1069–1072.
- 1984b: Tectonique synsédimentaire triasico-jurassique dans l'unité piémontaise de Rochebrune au Sud-Est de Briançon. *Bull. Soc. géol. France* (7) 26, 193–204.
- ERNST, W. G. 1979: Coexisting sodic and calcic amphiboles from relatively high pressure metamorphic belts and the stability of barroisitic amphibole. *Mineral. Mag.* 43, 269–278.
- GASPARIK, T. & LINDSLEY, D. H. 1980: Phase equilibria at high pressure of pyroxene containing monovalent and trivalent ions. *Mineral. Soc. Amer., Monograph series* 7, 309–339.

- GIDON, M., KERCKHOVE, C., MICHARD, A., TRICART, P., GOTTELAND, P., GOUT, C., LEBLANC, D., LEFEVRE, R., LE GUERNIC, J., MÉGARD-GALLI, J. & MICHEL-NOËL, G. 1994: Carte géologique de France (1/50 000), feuille Aiguille de Chambeyron (872). Bur. Rech. Géol. Min. Orléans.
- GOFFÉ, B. & VELDE, B. 1984: Contrasted metamorphic evolutions in the thrust cover units of Briançonnais zone (French Alps): a model for the conservation of HP-LT metamorphic assemblages. *Earth and Planet. Sci. Lett.* 66, 351–360.
- GOFFÉ, B., SCHWARTZ, S., LARDEAUX, J. M., BOUSQUET, R. 2004: Exploratory notes to the map: metamorphic structure of the western and ligurian Alps. *Mitt. der Österr. Mineral. Ges.* 149, 125–144.
- HANSEN, E. 1971: *Strain facies*. 207pp., Springer-Verlag, Berlin Heidelberg New York.
- HEINRICH, H. & ALTHAUS, E. 1988: Experimental determination of the reactions $4 \text{ lawsonite} + 1 \text{ albite} = 1 \text{ paragonite} + 2 \text{ zoisite} + 2 \text{ quartz} + 6 \text{ H}_2\text{O}$ and $4 \text{ lawsonite} + 1 \text{ jadeite} = 1 \text{ paragonite} + 2 \text{ zoisite} + 1 \text{ quartz} + 6 \text{ H}_2\text{O}$. *N. Jb. Mineral. Monatsh.* 11, 516–528.
- HOLLAND, T. J. B. 1980: The reaction albite = jadeite + quartz determined experimentally in the range 600–1200°C. *Amer. Mineral.* 65, 129–134.
- LAGABRIELLE, Y. 1987: Les ophiolites marqueurs de l'histoire tectonique des domaines océaniques: le cas des Alpes franco-italiennes (Queyras, Piémont) comparaison avec les ophiolites d'Antalya (Turquie) et du Coast Range de Californie. Unpublished thesis, University of Brest, 335pp.
- LAGABRIELLE, Y. & CANNAT, M. 1990: Alpine Jurassic ophiolites resemble the modern central Atlantic basement. *Geology* 18, 319–322.
- LAGABRIELLE, Y. & LEMOINE, M. 1997: Alpine, Corsican and Apennine ophiolites: the slow-spreading ridge model. *C. R. Acad. Sci., Paris sér. II* 325, 909–920.
- LAGABRIELLE, Y. & POLINO, R. 1987: Carte structurale des hautes vallées du Guil et du Haut Val Pellice. CNR Centro di studio sui problemi dell'orogeno delle Alpi occidentale, Torino.
- 1988: Un schéma structural du domaine des Schistes lustrés ophiolitifères au nord-ouest du massif du Mont Viso (Alpes Sud-Occidentales) et ses implications. *C. R. Acad. Sci., Paris sér. II* 306, 921–928.
- LEFÈVRE, R. & MICHARD, A. 1965: La Jadéite dans le métamorphisme alpin, à propos des gisements de type nouveau de la bande d'Acciglio (Alpes cottiennes italiennes). *Bull. Soc. géol. France* 7, 248–254.
- LEMOINE, M. 1967: Brèches sédimentaires marines à la frontière entre les domaines briannonnais et piémontais dans les Alpes occidentales. *Geol. Rdsch.* 1, 320–337.
- LEMOINE, M. & TRICART, P. 1979: Une partie des Schistes et des ophiolites du Queyras (Alpes françaises) résultent-ils de sédimentation et d'écroulements au pied d'un escarpement océanique? *C. R. Acad. Sci., Paris sér. D* 288, 1655–1658.
- 1986: Les Schistes lustrés piémontais des Alpes occidentales: approche stratigraphique, structurale et sédimentologique. *Eclogae geol. Helv.* 79, 271–294.
- 1993: From oceanic closure to continental collision: A synthesis of the “Schistes lustrés” metamorphic complex of the Western Alps: Alternative interpretation. *Geol. Soc. Amer. Bull.* 105, 845–849.
- LEMOINE, M., BOURBON, M. & TRICART, P. 1978: Le Jurassique et le Crétacé prépiémontais à l'Est de Briançon (Alpes occidentales) et l'évolution de la marge européenne de la Téthys: données nouvelles et conséquences. *C. R. Acad. Sci., Paris* 286, 1655–1658.
- LEMOINE, M., MARTHALER, M., CARON, M., SARTORI, M., AMAUDRIC DU CHAFFAUT, S., DUMONT, T., ESCHER, A., MASSON, H., POLINO, R. & TRICART, P. 1984: Découverte de foraminifères planctoniques du Crétacé supérieur dans les Schistes lustrés du Queyras (Alpes occidentales): conséquences paléogéographiques et tectoniques. *C. R. Acad. Sci., Paris sér. II* 11, 727–731.
- LEMOINE, M., BAS, T., ARNAUD-VANNEAU, A., ARNAUD, A., DUMONT, T., GIDON, M., BOURBON, M., DE GRACIANSKY, P.-C., RUDKIEWICZ, J.-L., MÉGARD-GALLI, J. & TRICART, P. 1986: The continental margin of the Mesozoic Tethys in the Western Alps. *Marine and Petroleum Geol.* 3, 179–199.
- LEMOINE, M., DE GRACIANSKY, P.-C. & TRICART, P. 2000: De l'océan à la chaîne de montagnes: tectonique des plaques dans les Alpes. 207p., Gordon & Breach Science, Paris.
- LOMBARDO, B., NERVO, R., COMPAGNONI, R., MESSIGA, B., KIENAST, J. R., MEVEL, C., FIORA, L., PICCARDO, G. B. & LANZA, R. 1978: Osservazioni preliminari sulle ophioliti metamorfiche del Monviso (Alpi occidentali). *Rend. Soc. ital. Mineral. Petrol.* 34, 253–305.
- MARESCH, W. V. 1977: Experimental study on glaucophane an analysis on present knowledge. *Tectonophysics* 43, 109–125.
- MAWHIN, B., JEANNETTE, D. & TRICART, P. 1983: Relations entre structures longitudinales et transverses au cœur de l'arc alpin occidental: exemple du Val Germanasca (Massif cristallin Dora-Maira). *C. R. Acad. Sci., Paris sér. II* 297, 749–752.
- MESSIGA, B., KIENAST, J. R., REBAY, G., RICCARDI, P. & TRIBUZIO, R. 1999: Cr-rich magnesiochloritoid eclogites from the Monviso ophiolites (Western Alps, Italy). *J. metam. Geol.* 17, 287–299.
- MICHARD, A., CHOPIN, C. & HENRY, C. 1993: Compression versus extension in the exhumation of the Dora-Maira coesite-bearing unit, Western Alps, Italy. *Tectonophysics* 221, 173–193.
- MOODY, J. B., MEYER, D. & JENKINS, J. E. 1983: Experimental characterization of the greenschist-amphibolite boundary in mafic system. *Amer. J. Sci.* 28, 48–92.
- NISIO, P. & LARDEAUX, J. M. 1987: Retromorphic Fe-rich talc in low-temperature eclogites: example from Monviso (Italian Western Alps). *Bull. Mineral.* 110, 427–437.
- OBERHÄNSLI, R., BOUSQUET, R., ENGI, M., GOFFÉ, B., GOSSO, G., HANDY, M., KOLLER, F., LARDEAUX, J. M., POLINO, R., ROSSI, P., SCHUSTER, R., SCHWARTZ, S. & SPALLA, I. 2004: Metamorphic structure of the Alps. 1:000000. CGMW, Paris.
- PHILIPPOT, P. 1988: Déformation et écolitisation progressives d'une croûte océanique subductée: le Monviso, Alpes occidentales. Contraintes cinématiques durant la collision alpine. *Doc. trav. Centre Géol. Géophys. Montpellier* 19, 269pp.
- SCHMID, S. M. & KISSLING, E. 2000: The arc of the western Alps in the light of geophysical data on deep crustal structure. *Tectonics* 19, 62–85.
- SCHWARTZ, S. 2002: La zone piémontaise des Alpes occidentales: un paléo-complexe de subduction. Arguments métamorphiques, géochronologiques et structuraux. *Doc. Bur. Rech. Géol. Min. Orléans* 302: 313pp.
- SCHWARTZ, S., LARDEAUX, J. M., GUILLLOT, S. & TRICART, P. 2000a: Diversité du métamorphisme écolitique dans le massif ophiolitique du Monviso (Alpes occidentales, Italie). *Geodin. Acta* 13, 169–188.
- SCHWARTZ, S., LARDEAUX, J. M., & TRICART, P. 2000b: La zone d'Acciglio (Alpes cottiennes): un nouvel exemple de croûte continentale écolitisée dans les Alpes occidentales. *C. R. Acad. Sci., Paris* 312, 859–866.
- SPEAR, F. S. 1993: Metamorphic Phase Equilibria and Pressure-Temperature-Time Paths. *Mineral. Soc. Amer., Monograph series*, 1–799.
- SUE, C. & TRICART, P. 2002: Widespread normal faulting in the Internal Western Alps: a new constrain on arc dynamics. *J. geol. Soc.* 159, 61–70.
- 2003: Neogene to ongoing normal faulting in the inner western Alps. *Tectonics* 22(5), doi:10.1029/2002TC001426.
- TAKESHITA, H., SHIMOYA, H. & ITAYA, T. 1994: White mica K-Ar ages in blueschist-facies rocks from the Piemonte “calc-schists” of the western Italian Alps. *The Island Arc* 3, 151–162.
- TRICART, P. 1975: les rétrocharriages dans les Alpes franco-italiennes, évolution des structures sur la transversale Embrunais-Queyras (Hautes-Alpes). *Sc. Géol. Bull. Strasbourg*, 28, 239–259.
- TRICART, P. 1980: Tectonique superposées dans les Alpes occidentales au Sud du Pelvoux, évolution structurale d'une chaîne de collision. Unpublished Thesis Strasbourg Univ., 407pp.
- 1984: From passive margin to continental collision: a tectonic scenario for the Western Alps. *Amer. J. Sci.* 284, 97–120.
- 1986: Le chevauchement de la zone briannonnaise au Sud-Est du Pelvoux: clé des rapports zone externe-zones internes dans les Alpes occidentales. *Bull. Soc. géol. France* 8, 233–244.
- TRICART, P. & LEMOINE, M. 1983: Serpentinitic oceanic bottom in South Queyras ophiolites (French Western Alps): record of the incipient oceanic opening of the Mesozoic Ligurian Tethys. *Eclogae geol. Helv.* 76, 611–629.
- 1986: From faulted blocks to megamullions and megaboudins: Tethyan heritage in the structure of the Western Alps. *Tectonics* 5, 95–118.

- 1988: A l'origine de la structure des Schistes lustrés à ophiolites du Queyras (Alpes françaises): un mode atypique d'obduction, conséquence de la structure particulière de la croûte océanique ligurienne. *C. R. Acad. Sci., Paris sér. II* 306, 301–306.
 - 1991: The Queyras ophiolite West of Mont Viso (Western Alps): indicator of a peculiar ocean floor in the Mesozoic Tethys. *J. Geodyn.* 13, 163–181.
- TRICART, P. & SUE, C. 2006: Faulted backfold versus reactivated backthrust: the role of inherited structures during late extension in the frontal Piémont nappes east of Pelvoux (Western Alps). *Int. J. Earth Sci.*, DOI 10.1007/s00531-006-0074-x.
- TRICART, P., BOURBON, M. & LAGABRIELLE, Y. 1982: Révision de la coupe Péouvou-Roche Noire (zone piémontaise, Alpes franco-italiennes): bréchification synsédimentaire d'un fond océanique ultrabasique. *Géol. alp. Grenoble* 58, 105–113.
- TRICART, P., GOUT, C. & LEMOINE, M. 1985a: Mosaïque de blocs faillés et injection de serpentinites dans la croûte océanique téthysienne: l'exemple des ophiolites de Chabrière (Haute Ubaye, Alpes occidentales françaises). *C. R. Acad. Sci., Paris sér. II* 16, 817–820.
- TRICART, P., AMAUDRIC DU CHAFFAUT, S., AYOUB, C., BALLÈVRE, M., CABY, R., GOUT, C., LAGABRIELLE, Y., LEBLANC, D., LE MER, O., PHILIPPOT, P. & SABY, P. 2003: Carte géologique de France (1/50 000), feuille Aiguilles-Col Saint Martin (848). *Bur. Rech. Géol. Min. Orléans*.
- TRICART, P., SCHWARTZ, S., SUE, C. & LARDEAUX, J. M. 2004: Evidence of synextension tilting and doming during final exhumation from analysis of multistage faults (Queyras Schistes lustrés, Western Alps). *J. struct. Geol.* 26, 1633–1645.
- VIALON, P. 1966: Etude géologique du massif cristallin Dora-Maira, Alpes cottiennes internes, Italie. Unpublished thesis, University of Grenoble, 282pp.

Manuscript received February 9, 2006

Revision accepted June 26, 2006

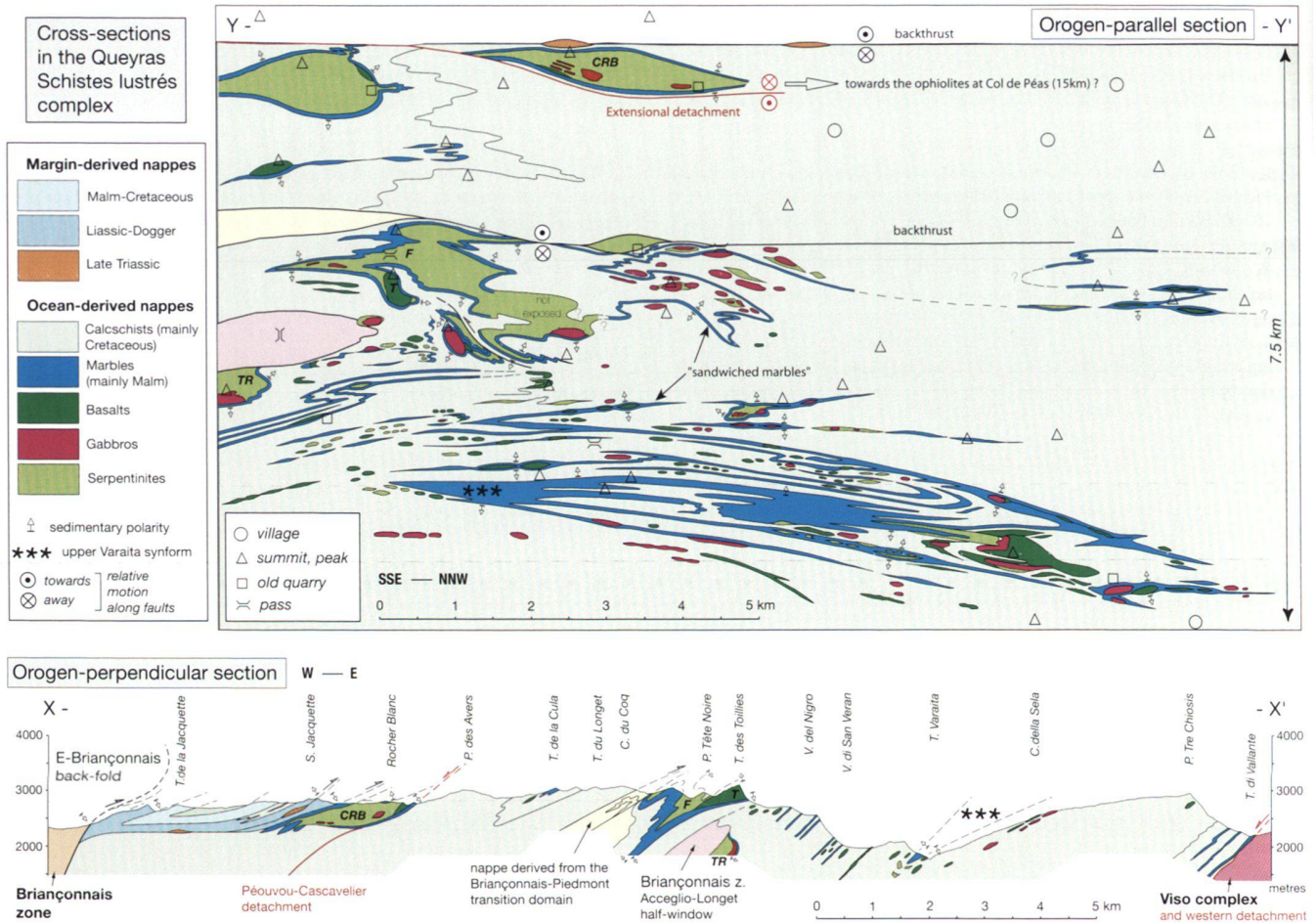

Plate 1

Cross-sections in the Queyras Schistes lustrés complex (location in Fig. 2). The ophiolitic massifs with abbreviated names are located in Fig. 2. The names of the villages, peaks, summits, passes and old quarries are given in Fig. 5. The orogen-perpendicular section XX' crosses the west-dipping Schistes lustrés tectonic pile between the main Briançonnais nappe stack to the west and the Viso ophiolitic nappe stack to the east (after Tricart et al. 2003, slightly modified). Since the section is nearly oriented E-W, it mainly displays the nearly N-S trending structures, which are also the latest ones: (i) the east-vergent folds (backfolds) and the associated thrusts (backthrusts, in black), resulting from the D4 deformation phase in the western part of the section, and (ii) the west-dipping extensional faults (in red) resulting from the D5 phase. The orogen-parallel section YY' was constructed by projecting the mapped structures onto a vertical plane oriented N170°E. The axis for projection is oriented N80°E, 30°W and corresponds to the mean axis of the F2 and F3 folds. The plunge of the projection axis results in a slight vertical expansion of beds and structures in the section. The important vertical development (7.5 km) of the section was allowed by the remarkably constant westward plunge of the F2 and F3 folds axes in the entire Queyras area. The section itself is represented with identical vertical and horizontal scales. Projection was operated from the west into the upper part of the section and from the east into its lower part. Since the validity of the construction decreases with distance, the projection plane was located in the eastern Queyras where the folded structure is most complex. The result of this general blind projection was only very locally corrected by hand-made adjustments where the axial plunge value was modified by late flexures and fault-associated drag-folds and where the offset of beds along late faults was too important (D5 event). The continuity of beds was extrapolated as little as possible, essentially where the structures are hidden beneath quaternary deposits.

Nevertheless the constructed structure is remarkably coherent at both regional and local scales. It is controlled by several generations of folds, identified as the F2 north-vergent recumbent folds and the F3 south-vergent folds, superimposed onto F1 perfectly isoclinal folds ("sandwiched marbles" and/or ophiolitic bands with opposite polarities). A vertical evolution in the general style of folding and boudinage is consistent with the regional west-to-east increase in the syntectonic metamorphic conditions. On the other hand, the submeridian F4 backfolds do not appear correctly (upper part of the section: compare with section XX') and the late west-dipping tectonic contacts are projected as horizontal lines onto the section.