

New Theridomyidae (Rodentia, Mammalia) in the Oligocene Molasse of Switzerland and Savoy

Autor(en): **Mayo, Néstor A.**

Objektyp: **Article**

Zeitschrift: **Eclogae Geologicae Helvetiae**

Band (Jahr): **80 (1987)**

Heft 3

PDF erstellt am: **23.09.2024**

Persistenter Link: <https://doi.org/10.5169/seals-166036>

Nutzungsbedingungen

Die ETH-Bibliothek ist Anbieterin der digitalisierten Zeitschriften. Sie besitzt keine Urheberrechte an den Inhalten der Zeitschriften. Die Rechte liegen in der Regel bei den Herausgebern.

Die auf der Plattform e-periodica veröffentlichten Dokumente stehen für nicht-kommerzielle Zwecke in Lehre und Forschung sowie für die private Nutzung frei zur Verfügung. Einzelne Dateien oder Ausdrucke aus diesem Angebot können zusammen mit diesen Nutzungsbedingungen und den korrekten Herkunftsbezeichnungen weitergegeben werden.

Das Veröffentlichen von Bildern in Print- und Online-Publikationen ist nur mit vorheriger Genehmigung der Rechteinhaber erlaubt. Die systematische Speicherung von Teilen des elektronischen Angebots auf anderen Servern bedarf ebenfalls des schriftlichen Einverständnisses der Rechteinhaber.

Haftungsausschluss

Alle Angaben erfolgen ohne Gewähr für Vollständigkeit oder Richtigkeit. Es wird keine Haftung übernommen für Schäden durch die Verwendung von Informationen aus diesem Online-Angebot oder durch das Fehlen von Informationen. Dies gilt auch für Inhalte Dritter, die über dieses Angebot zugänglich sind.

| | | | | |
|---------------------|---------|-------|----------------|----------------------|
| Eclogae geol. Helv. | Vol. 80 | Nr. 3 | Pages 995–1085 | Basel, December 1987 |
|---------------------|---------|-------|----------------|----------------------|

New Theridomyidae (Rodentia, Mammalia) in the Oligocene Molasse of Switzerland and Savoy

By NÉSTOR A. MAYO¹⁾

ZUSAMMENFASSUNG

Es werden achtzehn Taxa – unter ihnen zwölf neue und zwei wieder eingeführte – von drei Theridomyidae Unterfamilien beschrieben. Von der Unterfamilie Theridomyinae: *Isoptychus*; *Isoptychus bumbachensis* n. sp.; *Blainvillimys*; *B. blainvillei* und *Blainvillimys stehlini* n. sp. Von der Unterfamilie Issiodoromyinae: *Issiodoromys*; *I. (Issiodoromys)*; *I. (Saboyanomys)* n. subg.; *I. (S.) weidmanni* n. subg. n. sp.; *I. (S.) oppligeri* n. sp.; *I. (S.) rickenbachensis* n. sp.; *Nesokerodon*; *N. balmensis* n. sp.; *N. aarwangensis* n. sp.; *Oensingenomys* n. gen.; *O. ravelensis* n. gen. n. sp. und *O. huerzeleri* n. sp. Von der Unterfamilie Archaeomyinae: *Toeniodus*; *T. curvistriatus*; *T. ernii* n. sp. und *Archaeomys (Archaeomys) kaelini* n. sp.

Sämtliche neuen Taxa stammen vom oligozänen Molassebecken der Schweiz und Savoyen. Sie werden für die biostratigraphische Zonierung der Süßwassermolasse als Leitfossilien gebraucht und ihr Alter kann zwischen dem obersten Unteroligozän (Zone von Balm) und dem oberen Oligozän (Zone von Rickenbach) eingestuft werden. Sämtliche Taxa wurden aufgrund der maximalen verfügbaren Merkmale des Kauapparates (Maxillar- und Mandibularfragmente und Zahnstrukturen) und der Foramina (weniger dem Selektionsdruck unterworfen) bestimmt.

RESUMEN

Dieciocho taxa de tres Subfamilias de Theridomyidae, entre ellos doce nuevos y dos reintroducidos, son descritos. De la Subfamilia Theridomyinae: *Isoptychus*; *Isoptychus bumbachensis* n. sp.; *Blainvillimys*; *B. blainvillei* y *Blainvillimys stehlini* n. sp. De la Subfamilia Issiodoromyinae: *Issiodoromys*; *I. (Issiodoromys)*; *I. (Saboyanomys)* n. subg.; *I. (S.) weidmanni* n. subg. n. sp.; *I. (S.) oppligeri* n. sp.; *I. (S.) rickenbachensis* n. sp.; *Nesokerodon*; *N. balmensis* n. sp.; *N. aarwangensis* n. sp.; *Oensingenomys* n. gen.; *O. ravelensis* n. gen. n. sp. y *O. huerzeleri* n. sp. De la Subfamilia Archaeomyinae: *Toeniodus*; *T. curvistriatus*; *T. ernii* n. sp. y *Archaeomys (Archaeomys) kaelini* n. sp.

Todos los taxa nuevos provienen de la cuenca molásica oligocena de Suiza y de Saboya. Ellos son empleados como fósiles índices en la escala bioestratigráfica de la Molasa de Agua Dulce y sus edades estimadas van desde el Oligoceno Inferior más superior (zona de ensamble de Balm) al Oligoceno Superior (zona de ensamble de Rickenbach). Todos los taxa han sido determinados usando el máximo de caracteres disponibles en los aparatos masticatorios (fragmentos maxilares, mandibulares y estructuras dentarias), entre ellos los foramina (menos dependientes de las presiones de selección).

ABSTRACT

Eighteen taxa of three Subfamilies of Theridomyidae are described, among them twelve new and two reintroduced. Of the Subfamily Theridomyinae: *Isoptychus*; *Isoptychus bumbachensis* n. sp.; *Blainvillimys*; *B. blainvillei* and *Blainvillimys stehlini* n. sp. Of the Subfamily Issiodoromyinae: *Issiodoromys*; *I. (Issiodoromys)*; *I. (Saboyanomys)* n. subg.; *I. (S.) weidmanni* n. subg. n. sp.; *I. (S.) oppligeri* n. sp.; *I. (S.) rickenbachensis* n. sp.; *Nesokerodon*; *N. balmensis* n. sp.; *N. aarwangensis* n. sp.; *Oensingenomys* n. gen.; *O. ravelensis* n. gen. n. sp. and *O. huerzeleri* n. sp. Of the Subfamily Archaeomyinae: *Toeniodus*; *T. curvistriatus*; *E. ernii* n. sp. and *Archaeomys (Archaeomys) kaelini* n. sp.

¹⁾ Naturhistorisches Museum, Augustinergasse 2, CH-4001 Basel.

All the new taxa were found in the Oligocene Molasse basin of Switzerland and Savoy. They are used as fossil indices in the biostratigraphical scale of the Lower Freshwater Molasse and their estimated age is from the top of the Lower Oligocene (assemblage zone of Balm) to the Upper Oligocene (assemblage zone of Rickenbach). All the taxa have been determined using the maximum available characters of the masticatory apparatus (maxillary and mandibular fragments and dentary structure) among them the foramina (less dependently of the selection pressures).

CONTENTS

| | |
|--|------|
| Introduction..... | 996 |
| Taxonomic procedure..... | 998 |
| Terminology..... | 1000 |
| Measurements..... | 1005 |
| Abbreviations..... | 1008 |
| Subfamily Theridomyinae..... | 1009 |
| Genus <i>Isoptychus</i> | 1009 |
| <i>Isoptychus bumbachensis</i> n. sp..... | 1013 |
| Genus <i>Blainvillimys</i> | 1016 |
| <i>Blainvillimys blainvillei</i> | 1018 |
| <i>Blainvillimys stehlini</i> n. sp..... | 1020 |
| Subfamily Issiodoromyinae..... | 1025 |
| Genus <i>Issiodoromys</i> (<i>Issiodoromys</i>)..... | 1025 |
| Subgenus <i>Issiodoromys</i> (<i>Issiodoromys</i>)..... | 1026 |
| Subgenus <i>Issiodoromys</i> (<i>Saboyanomys</i>) n. subg..... | 1026 |
| <i>I. (Saboyanomys) weidmanni</i> n. subg. n. sp..... | 1026 |
| <i>I. (Saboyanomys) oppligeri</i> n. sp..... | 1032 |
| <i>I. (Saboyanomys) rickenbachensis</i> n. sp..... | 1035 |
| Genus <i>Nesokerodon</i> | 1039 |
| <i>Nesokerodon balmensis</i> n. sp..... | 1041 |
| <i>Nesokerodon aarwangensis</i> n. sp..... | 1046 |
| Genus <i>Oensingenomys</i> n. gen..... | 1048 |
| <i>Oensingenomys ravelensis</i> n. gen. n. sp..... | 1051 |
| <i>Oensingenomys huerzeleri</i> n. sp..... | 1054 |
| Subfamily Archaeomyinae..... | 1057 |
| Genus <i>Toeniodus</i> | 1057 |
| <i>Toeniodus curvistriatus</i> | 1059 |
| <i>Toeniodus ernii</i> n. sp..... | 1068 |
| Genus <i>Archaeomys</i> | 1076 |
| Subgenus <i>Archaeomys</i> (<i>Archaeomys</i>)..... | 1076 |
| <i>Archaeomys (Archaeomys) kaelini</i> n. sp..... | 1076 |
| Acknowledgments..... | 1082 |
| Bibliography..... | 1083 |

Introduction

The biozonation of the Lower Freshwater Molasse of Switzerland and Savoy will soon be published. This work is based on the study of a considerable quantity of fossil-remains. Among them the eomyids, cricetids, lagomorphs and theridomyids proved to be the best fossil index. This paper is about the last group of rodents mentioned above, and the purpose here is to describe species that are used as reference fossils in the biozonation.

During the elaboration of our biostratigraphic scale (ENGESSER & MAYO 1987), a special study of the rodent Family Theridomyidae ALSTON 1876 took place. Therefore several papers were published concerning theridomyids (MAYO 1980, 1981, 1982 and

1983), or where the theridomyids were used as biostratigraphic references (MAYO 1984 and 1986 in: ENGESSER et al.) and others will follow. In the case of Issiodoromyinae, a monograph (MAYO 1987) will supply additional information. For this reason, the descriptions in this paper are largely concerned with the systematics. The first part concerning the Subfamily Archaeomyinae has been published (MAYO 1983). Nevertheless, the increase in knowledge has necessitated the elevation in rank of the taxa from subgenera to genera.

The study of this Family (which is for the first time restricted to the successive beds of a single basin) has shown some of the problems of the previously proposed lines of successional species, in which species were found in different basins, and were considered as distributed all over Europe (THALER 1966, and VIANEY-LIAUD 1973, 1976 and 1979); an assumption that I find mistaken. It is well known that parallelisms are very typical in the phylogeny of the rodents, and this that applies especially to the Theridomyidae. The principal problem concerning this Family is that after STEHLIN & SCHAUB (1951), LAVOCAT (1952), DECHASEUX (1963) and THALER (1966), the literature has tended to allocate the different species to only one or two genera, with the purpose of recognizing only one or two lines of evolution within each Subfamily. The genus *Theridomys* JOURDAN 1837 is an example of this. On the basis of a reduced number of characters, it was possible to place species together that were once thought separate.

BOSMA (1974) clearly saw such problems and went back to the previously abandoned point of view of STEHLIN & SCHAUB (1951) and LAVOCAT (1952). For this she had well founded arguments: "VIANEY-LIAUD (1972b) [1973] and HARTENBERGER (1973) considered *Isoptychus* to be synonymous with *Theridomys*, as they believed that the *Theridomys* species evolved from the *Isoptychus* species. In our opinion, supposed phylogenetical relations are no good reason for the allocation to one genus. Most species of *Isoptychus* and *Theridomys* show consistent differences in dental structure and therefore it is preferable to maintain both genera. Species proving to be intermediate in dental structure between *Isoptychus* and *Theridomys* may be referred to one genus or the other in an arbitrary way" (1974, p. 80). This elementary principle that genera are established by generic characters, in the study of theridomyids has been forgotten in recent years. Unfortunately BOSMA, who realized this, could not continue her studies on this group of rodents. Nevertheless, the discovery of fossil remains of *Isoptychus bumbachensis* n. sp. in the Molasse basin of Switzerland – living approximately at the same time as *Theridomys lembronicus* BRAVARD, in GERVAIS, 1848–52, or even younger – has demonstrated that BOSMA's point of view was right. On the other hand, the study of skull fragments, foramina, mandibles and dental structure has allowed the reintroduction of the *Isoptychus* genus, back into Theridomyinae as well as others. *Trechomys* LARTET 1869 has enough generic characters to be maintained separately from *Theridomys* JOURDAN 1837. I believe *Theridomys* arose from *Trechomys*. Until now, we have had a gap between the species that permits us to establish this opinion (*Trechomys major* and *Theridomys lembronicus*). Probably this gap may be filled when the study of the basins in Spain is ready. In spite of this, *Isoptychus* is not a single taxon. At the moment there is evidence that suggests that it will be possible in the near future, to separate it into two subgenera, one with two lines of successional species, with one larger than the other. The same problems of the Theridomyinae occur with two other Subfamilies: Archaeomyinae LAVOCAT 1952 and Issiodoromyinae LAVOCAT 1952. Only one line of successional species

was recognized for each of them. The study of theridomyids in the Molasse basin of Switzerland and Savoy demonstrates that both Subfamilies are very complicated. Some of these problems, concerning Archaeomyinae, can be found in my papers cited above (1981 and 1983), those concerning Issidoromyinae will be presented in this paper.

Taxonomic procedure

Under "previous diagnoses" are mentioned some authors who did not offer a real diagnosis although it is possible to find it in their descriptions.

Emended diagnoses are given for most of the taxa, as it seems necessary for the proposition of several new taxa and also for the reintroduction of others which in the relatively recent literature were considered synonyms, or not distinguished at all on the basis of too few numbers of characters. For this purpose a considerable number of generic and subgeneric characters are proposed, and several of the old ones have been reevaluated. The importance of the generic or specific characters must be comprehended by their utilization, and any additional explanation will generally not be offered in this paper.

The generic characters have been based on the complete masticatory apparatus. This is because the maxillary and mandibular fragments are not infrequently represented in the beds, associated with the more frequent dentary structures. The maxillary and mandibular fragments permit us to follow the modifications of the masticatory apparatus, which occur by adaptations to many specific niches in the different sequences of the basin beds. Characters based on the masticatory system are very good, because it is well known that they have been subjected to greater selection pressure. On the contrary, foramina are less involved in such selection pressure. Thus, a reasonable balance between the characters permits us to follow the relationship of a new lineage as distinct from others that have arisen due to parallelisms. The foramina connected with the masticatory apparatus, have also been used as generic characters. Skulls are very rare in stratigraphic localities. For this reason I do not pay much attention to the cranial foramina, in spite of this I do not agree with LANDRY (1957, p. 8) in the taxonomic value of them, but I am closer to the opinion of LAVOCAT (1952 and 1971), PATTERSON & WOOD (1982) and WAHLERT (1974, 1977 and 1978)²). Slight modifications in the structure or in the position of these characters have been used to fit the boundaries of interspecific variation. Nevertheless, the modification of the dentary structure has been taken into account, as the results in regard interspecific variation are the most useful. In all cases, the maximum available characters have been used.

In the literature there are some cases where a relatively great difference of position of the incisive foramina has been considered only of interspecific value (see BOSMA 1974, Pl. II, Fig. 4 and 5). In my view such a relatively large modification in the position and the structure of the incisive foramina has a higher taxonomic importance. In the case referred to, it is possible to see the concurrence in the specimens of other important characters above the species level. For instance, the fossette for the *M. masseter superficialis* in *Isoptychus headonensis* BOSMA 1974 and the near absence of it in *Isoptychus pseudosiderolithicus* DE BONIS 1964, which has a more distinctive masseteric ridge and so on (I could

²) Prof. Landry who has read this manuscript in part, told me that he is now in agreement with this opinion.

not examine the specimens). The same occurs with the two specimens of *Isoptychus* figured by VIANEY-LIAUD (1973, p. 306, Fig. 5). In both cases, similar different characters concerning the fossa for the superficial masseteric muscle are represented. In addition, the presence of a fully developed mesoloph in *I. headonensis* and the incomplete development of the mesoloph in *I. pseudosiderolithicus* may be an important character distinguishing the taxa at a higher level. VIANEY-LIAUD (1979, p. 148) identified the species *I. headonensis* BOSMA 1974 as belonging to the genus *Thalerimys* TOBIEN 1972. This opinion is followed also by HOOKER (1986, p. 422). But at least in the maxillary fragment assigned to *I. headonensis*, there are represented several diagnostic characters of *Isoptychus*, which cannot be found in the species *pseudosiderolithicus*. On the other hand, I have the same opinion as HOOKER (1986) about the value of the wrinkled enamel in isolation from other characters. I believe that it is the same applies to teeth with many protuberances and no other related characters.

Something similar occurs with the structure of the infraorbital canal ventral to the infraorbital foramen. Concerning Theridomyidae, I stand by my previous point of view about the value of this character, as I have found it to be very useful (1982, p. 699–701, Fig. 1). That is, when there are several maxillary fragments of the same taxon available in a layer, its range of variation is very small and above all, a similar structure is maintained in all of the specimens. A deep infraorbital canal should be considered as a “primitive” generic character. In the transition towards loss of it, a single specimen can have a part of the maxilla without the canal and an other one with a very shallow canal, for instance, like the Holotype of *Protechimys* (*Protechimys*) *gervaisi* (THALER 1966). But loss and acquisition of a deep infraorbital canal with high variation of its external ridge – as considered by VIANEY-LIAUD (1973) for the “*Theridomys*” and “*Blainvillimys*” lines – does not occur in the same genus. In Theridomyids it seems to be that the tendency is for the gradual loss of the deep infraorbital canal in Theridomyinae, to maintain it with slight modifications in Issiodoromyinae and to lose it completely in Archaeomyinae.

Applying the Student t-test, the 5 per cent level of significance – as is usual – has been chosen. For the Pearson’s coefficient of variation SIMPSON et al. (1960) has been followed. But FREUDENTHAL & CUENCA’s coefficient of variation has also been taken into account (FREUDENTHAL & CUENCA BESCOS 1984). Concerning the Theridomyidae populations of stratigraphic localities, most of the Pearson’s coefficient of variation for length of $M^{1/2}$ or $M_{1/2}$ is between 4 and 6 (as example see p. 1079, Tab. 54). Rarely it was found to be $c8$ and when it is really higher than 8 – with N good enough –, generally there was clear evidence of other closely related species represented in the sample. Typical examples of this are the samples with Theridomyidae of the carstic fissure filling of Pech Desse and Pech du Fraysse (see VIANEY-LIAUD 1976 and 1979), where it is possible to apply the SIMPSON’s rule: “Much higher values [than 10] usually indicate that the sample was not pure, for instance, that it included animals of decidedly different ages”. I am also following GINGERICH (1974 and 1976) in the interpretation of the values of V for the Pearson’s coefficient of variation. Values of V higher than 8 for the length of $M^{1/2}$ and $M_{1/2}$ – contrary to the opinion of VIANEY-LIAUD (1976 and 1979) and VIANEY-LIAUD & LEGENDRE (1986) – are considered as representative of more than one species. It should be assumed that where N is too small for V to be significant, that despite this, V will be shown. This because it is useful for comparisons with other stratigraphic samples with few or only a

single specimen, and this can be compared by using the logarithmic method of plotting. As an exception, where V is very high because there are too few specimens, it will be considered useless to mention it.

Terminology

The terminology for the teeth of STEHLIN & SCHAUB (1951) has been followed. I am also using some terms described in previous papers (1981, p. 1011 and 1983, p. 832, 833 and 898, Fig. 54) although this is with reference to other genera (Fig. 1).

Pseudograben is the union in the upper teeth between the sinus and some syncline, or in the lower ones between the sinusid and some synclinid. This union is variable. Its deepness changes with the genera and species. Generally, all the Oligocene generic taxa of Theridomyidae – with the exception of *Isoptychus* – follow this evolutionary tendency. Although in mosaic: with different rhythm and on different teeth. The pseudograben is an intermediary step. Its union occurs during the evolutionary process from a shallow to a relatively deep depth. Its presence in some teeth (for instance in M^1 – M^2) or absence in others (e.g. P^4 or M^3) shows the differences among or within different lines of evolution. The pseudograben always permits us to see, at least at some point in its stage of wear, the union of the sinus with some syncline, or the sinusid with some synclinid. At some posterior stage of wear, the sinus or the sinusid will be separated from the syncline or synclinid. The sinus could be joined in a pseudograben in the upper teeth with the following syncline: in *Toeniodus* – although only shallowly – with I or II syncline; in *Protechimys*, *Archaeomys*, *Monarchaeomys*, *Rhombarchaeomys*, *Issidoromys*, *Nesokerodon* and *Oensingenomys* with the II syncline. The sinusid is joined in the lower teeth with the following synclinids: *Toeniodus* with IV synclinid (see explanation p. 1070–71). *Theridomys*, *Trechomys* and *Blainvillimys* also with the IV synclinid but only shallow in depth. *Protechimys*, *Issidoromys*, *Nesokerodon* and *Oensingenomys* with the III synclinid. The pseudograben stage in the lower teeth of *Archaeomys*, *Monarchaeomys* and *Rhombarchaeomys* is as yet unknown (Fig. 1).

Graben is a posterior evolutionary stage. The union between sinus or sinusid respectively with a syncline or synclinid is fully developed. The pseudograben is now transformed into a graben, and the separation of the sinus or sinusid with the syncline or synclinid does not occur any more in any stage of wear (Fig. 1).

Semigraben is sinus-like or sinusid-like, but very much longer. It appears when the labial aperture of the graben in the upper teeth, or the lingual in the lowers, is closed by abrasion. The extrasinus or extrasinusid distance (see below, p. 1005) is generally very small. The presence of graben and pseudograben and sinus or sinusid and semigraben is shown in some species, with a distinct boundary or grade of evolution in the same population. In such rare cases it will be designated in an arbitrary way as “semigraben” or “sinus” and “sinusid”, depending of the predominant evolutionary stage in the population (see below, p. 1005 and Fig. 1).

Tubular syncline or synclinid is a relatively “primitive” stage of evolution in Theridomyidae (see MAYO 1980, p. 1014, Fig. 2 and 1983, p. 898, Fig. 54). In unworn teeth it is generally very broad. In the worn stage it is a more or less broad island of enamel on the occlusal surfaces. It is typical for Theridomyinae, Issidoromyinae and some synclines of Archaeomyinae.

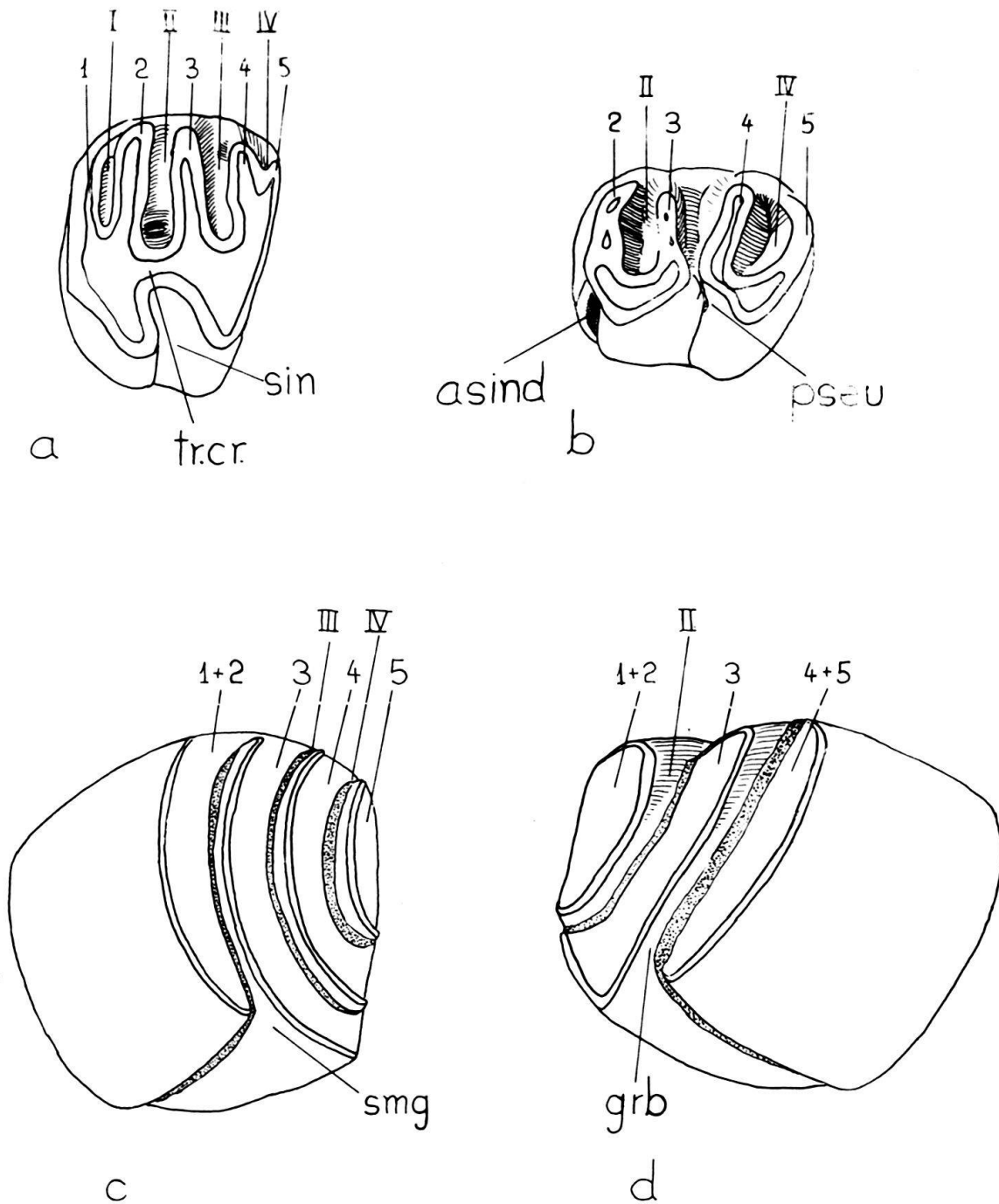

Fig. 1. Dental nomenclature of the teeth. - a = left upper molar. b = left lower molar of *Nesokerodon*. c = left upper molar. d = left lower molar of *Archaeomys*. Abbreviations: 1,2,3,4 and 5 = antyclines or antyclinids; I, II, III, IV and V = synclines or synclinids; pseu = pseudograben; sin = sinus; sind = sinusid; grab = graben; semig = semigraben Tr.cr. = transversal crest.

Pseudolaminar syncline or synclinid in unworn teeth is narrower or somewhat laminar, but in the worn stage is even tubular. It occurs in *Theridomys*, *Blainvillimys*, primitive *Archaeomyids* and in earlier stages of evolution of *Archaeomys* (*Archaeomys*).

Laminar syncline or synclinid is an evolved stage. In unworn teeth the synclines or synclinids are narrower. In the completely worn stage they clearly maintain the laminar stage, and the tubular stage does not appear and more. Generally in the evolution of this stage, the syncline or synclinid begins to fill partially with cellular cement. It is typical for the earlier stages of evolution of Archaeomyinae, but occurs in mosaic; also in some synclines and synclinids of Theridomyinae.

Filling laminar syncline or synclinid. – The synclines or synclinids are filled with a relative fine lamina of cellular cement.

Fully filling laminar syncline or synclinid is the upper most stage of evolution. Only in unworn teeth at a shallow level could there be some space without cellular cement. Soon, in the worn stage there appears a thick lamina of cellular cement sandwiched between a thick border of enamel, and another very much finer. This lamina of cement occurs together with the dentine in the assymetrical excavation which occurs between the enamel crests of the occlusal surface in worn stage.

Hypsodontic teeth. – Teeth with post-eruptional growth. I am following MONES (1968, p. 14 and 1982, p. 107) which recognizes two types: protohypsodont and euhypsodont.

Protohypsodontic teeth. – Teeth with a high crown and limited growth.

Euhypsodontic teeth. – Teeth with an ever growing high crown.

Semihypsodontic teeth. – This term seems to have been introduced by VIANEY-LIAUD (1976, p. 34) but not in a constant sense (cf. VIANEY-LIAUD 1976, p. 5). I am using it in a sense closer to PATTERSON & WOOD (1982, p. 416) for design cheek teeth that display unilateral hypsodonty. The upper teeth are lingually high crowned but with limited growth and almost brachyodont or lower crowned labially. In the semihypsodontic teeth of the Theridomyidae (and this is a difference of views from VIANEY-LIAUD and PATTERSON & WOOD), the crown does not have significant post-eruptional growth. The sinus or sinusid are completely closed at the moment of eruption by its base. Then, only the roots are growing. Nevertheless, it is quite possible that in Issidoromyinae at some moment of its evolution from semihypsodontic teeth toward protohypsodontic teeth there appears the grade of posteruptional growth. In this case I suggest the use of MONES's term: protohypsodontic teeth.

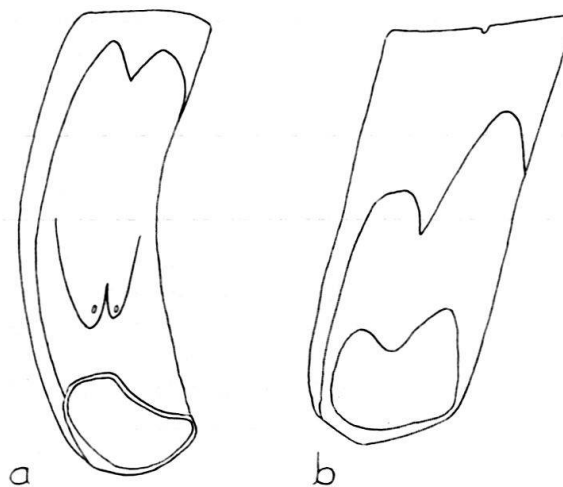

Fig. 2. Lobules on the teeth of *Issidoromys*. – a = labial lobules of the upper teeth. b = lingual lobules of the lower teeth.

Lobules. They occur in pairs on the labial border of the upper teeth or in the lingual of the lowers (Fig. 2). By their morphology, they are key generic or subgeneric characters. On the other hand, their increase or reduction in size are useful at interspecific level. It is possible to separate them as follows:

1. *Lobules without enamel*: 1.1 small and narrow: *Nesokerodon*. 1.2 small and broad: *Oensingenomys* n. gen. 1.3 long and narrow: *Issiodoromys* (*Issiodoromys*).

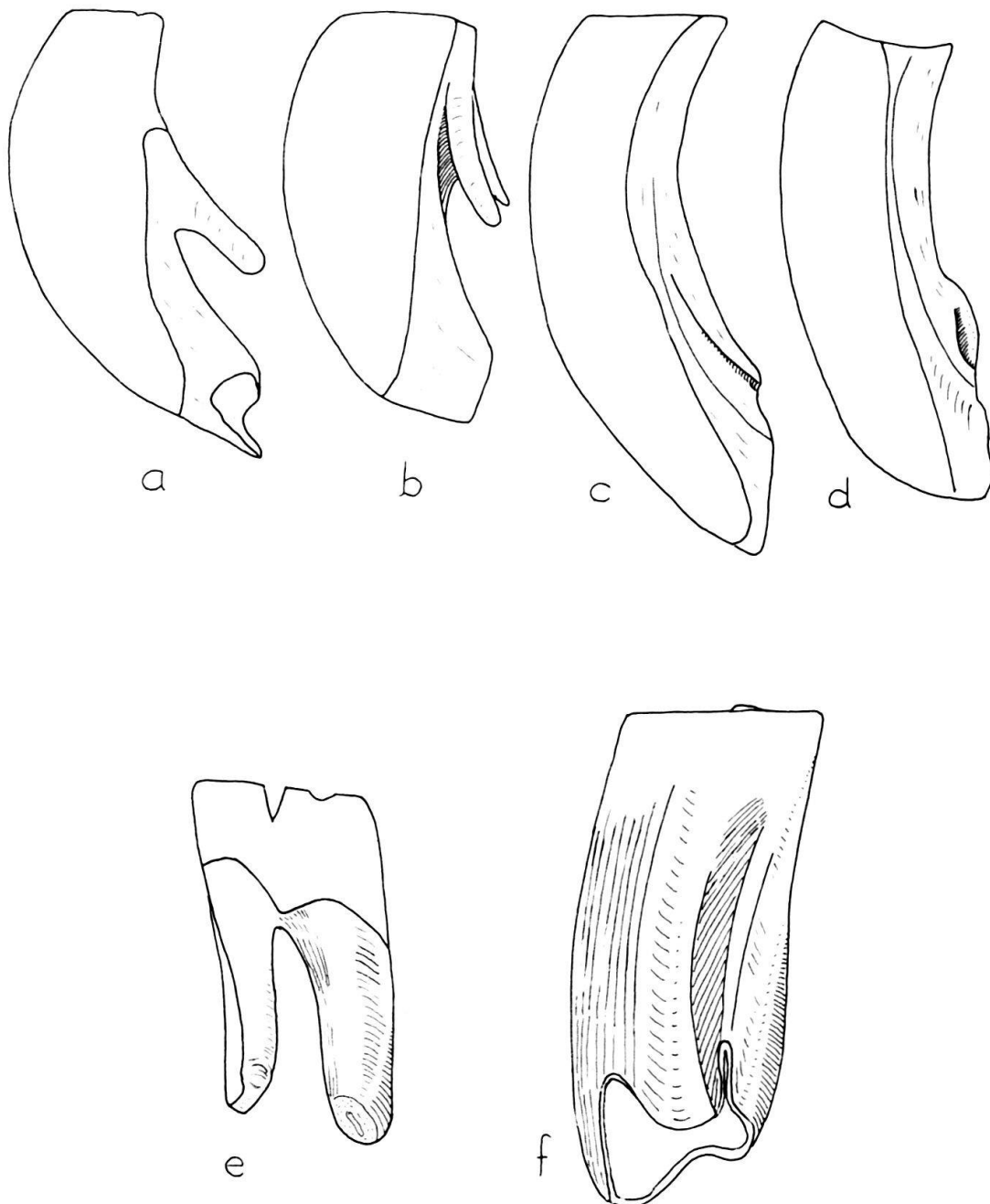

Fig. 3. Process of atrophication of the roots in Issiodoromyinae. – a = normal upper labial roots in *Nesokerodon*. b = normal lower roots in *Nesokerodon*. c = semiatrophied upper labial roots. d = atrophied upper labial roots. e = verstigial upper labial roots. f = slipping crest on lingual lower roots.

2. *Lobules with enamel present but very reduced*: 2.1 long and narrow: *Issidoromys* (*Saboyanomys*) n. subg. The last one (2.1) is, probably, an intermediate stage prior to 1.3.

Normal roots. Roots without signs of atrophy due to hypsodontic (protohypsodontic) processes (Fig. 3).

Semiatrophied roots. – In the upper teeth the small labial roots show some part of their basal root body fused with the cylinder of the crown. The rest of the root is free. With the increase of the hypsodnty, the tendency is to increase the fused part, and to reduce the free part (Fig. 3).

Atrophied root. – Most of the part of the body is fused with the cylinder of the crown (Fig. 3).

Fully atrophied roots: – The roots are completely fused to the cylinder of the crown, but they are still distinguishable (Fig. 3).

Vestigial roots. – The roots are very reduced, only represented by a stump (Fig. 3).

Slipping crest. – The fused part of the root with the loss of its semioval form to acquire a sharp morphology (Fig. 3).

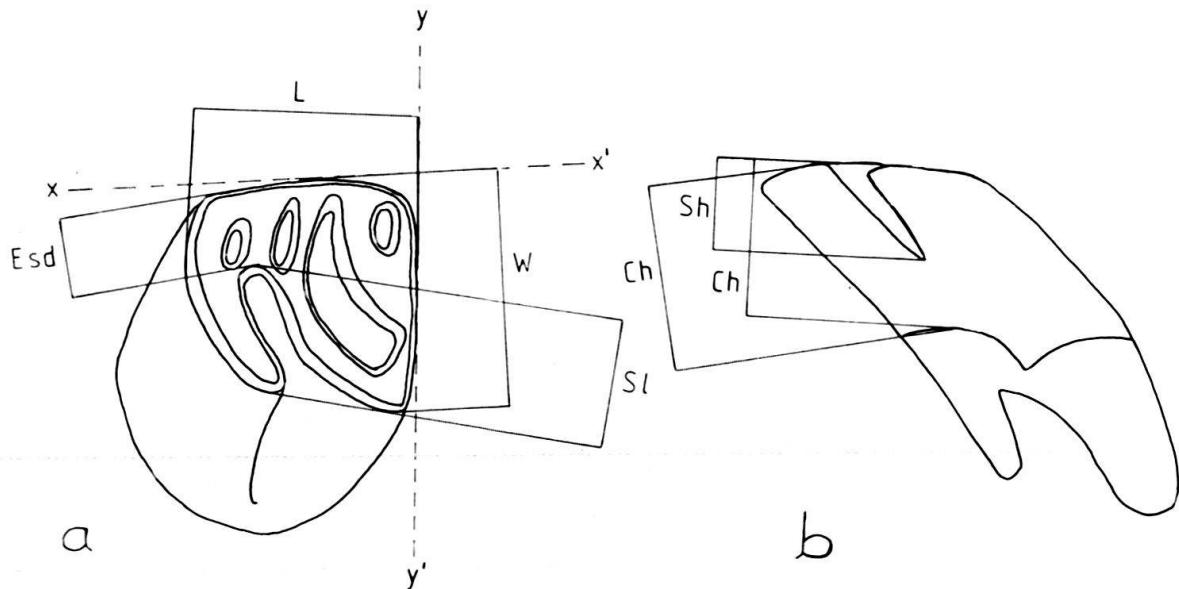

Fig. 4. Measurements of the teeth. – a) Measurements on the crown surface: L = length: the teeth are orientated along an ideal line (y–y') from labial to lingual border of the crown. The length is measured perpendicularly to this line. W = width: The teeth are orientated along an ideal line (x–x') parallel to the labial border in the upper teeth and parallel to the lingual border of the lowers. The width is measured perpendicularly to this line. Sl = sinus length: the length of the sinus is measured perpendicularly to an ideal line which joins the anterior with the posterior border of the sinus or the semigraben in the upper teeth. Sld = sinusid length (not figured): it is the same measurement as Sl but for the lower teeth. Esd = extrasinus distance: it is the measure of the shorter distance between the labial border of the crown and the sinus or semigraben end. Esdd = extrasinusid distance (not figured): is the same measurement as Esd for the lower teeth. b) Measurements in lingual view for the upper teeth (or in labial view for the lowers). Sh = sinus height: the sinus height of the upper teeth is measured between the sinus base and the occlusal surface on an ideal join of the anterior and posterior border of the sinus. Sdh = sinusid height: is measured in the same way as the sinus height but on the lower teeth. Ch = crown height: (for Archaeomyids): the upper teeth are measured between the posterior border of the sinus on the crown surface and the low border of the crown, oriented on a line which carry over the basis of the sinus. For the lower teeth the measurement is the same as the anterior one, but taken from the anterior border of the sinusid on the occlusal surface. For the Theridomyinae, Issidoromyinae and *Toeniodus* the crown height is taken as in sinus or sinusid height but from the low crown border.

Measurements

Length and width are measured on the occlusal surface of the crown in all the Theridomyidae (Fig. 4). To distinguish the variation of the crown size in worn stages, the teeth have been divided into five stages of wear (from SW-1 to SW-5).

Issiorodomyinae. – SW-1: unworn or almost unworn stages; SW-2: pseudograben is represented; SW-3: pseudograben absent and in addition to the II syncline in the upper teeth or to the III synclinid in the lowers, other syncline(s) or synclinid(s) must be represented; SW-4: sinus and II syncline or sinusid and III synclinid are present; SW-5: syncline or synclinid are not represented on the occlusal surface of the teeth (Fig. 5). In the semihypsodontic teeth with low crown height the synclines or synclinids only disappear in a very advanced worn stage. In these cases SW-4 is considered when, on the transversal crest the dentine is represented without enamel-interruptions (Fig. 18). That special case, where the taxon has a part of its lower teeth without pseudograben, will be explain below.

For Theridomyinae and Archaeomyinae the explanation will also be offered below.

Sinus length is the measurement in the upper teeth of the length of the sinus or of the semigraben. One measures on the occlusal surface the distance between the lingual borders and the labial end of the sinus or the semigraben (Fig. 4).

Sinusid length is the same measure as in sinus length, but in the lower teeth.

Extrasinus distance is the measure on the occlusal surface of the distance between the labial end of the sinus and the closer labial border of the crown (Fig. 4).

Extrasinusid distance is the same measure as above but in the lower teeth.

The last four measurements described above establish in quantitative terms a general tendency of the Theridomyidae toward lamination of the teeth and they are also useful when applied to the species of almost all genera.

Sinus height: This measurement could be taken with more frequency than the crown height, especially on the teeth included on maxillary or mandibular bones, or where the

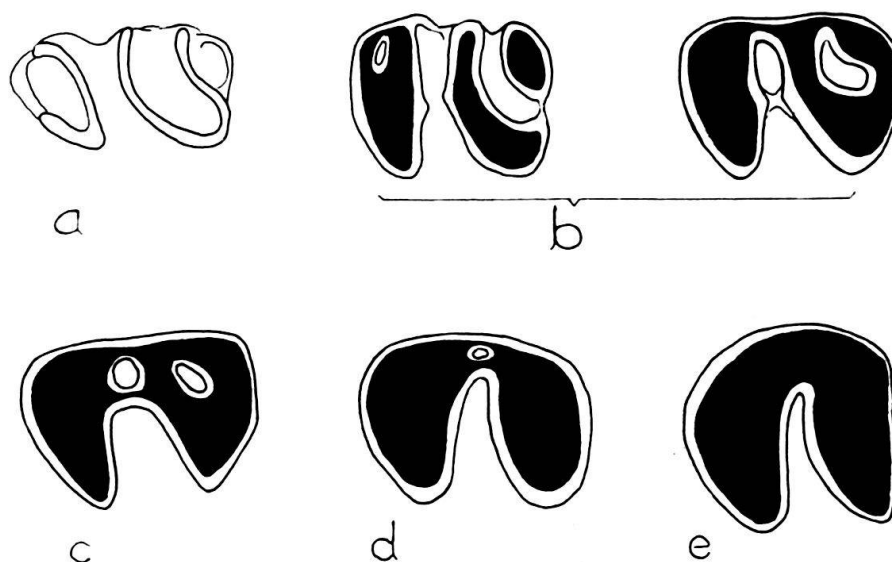

Fig. 5. Different stages of wear on upper teeth of *Issiodoromys*. a = SW-1. b = SW-2. c = SW-3. d = SW-4. e = SW-5.

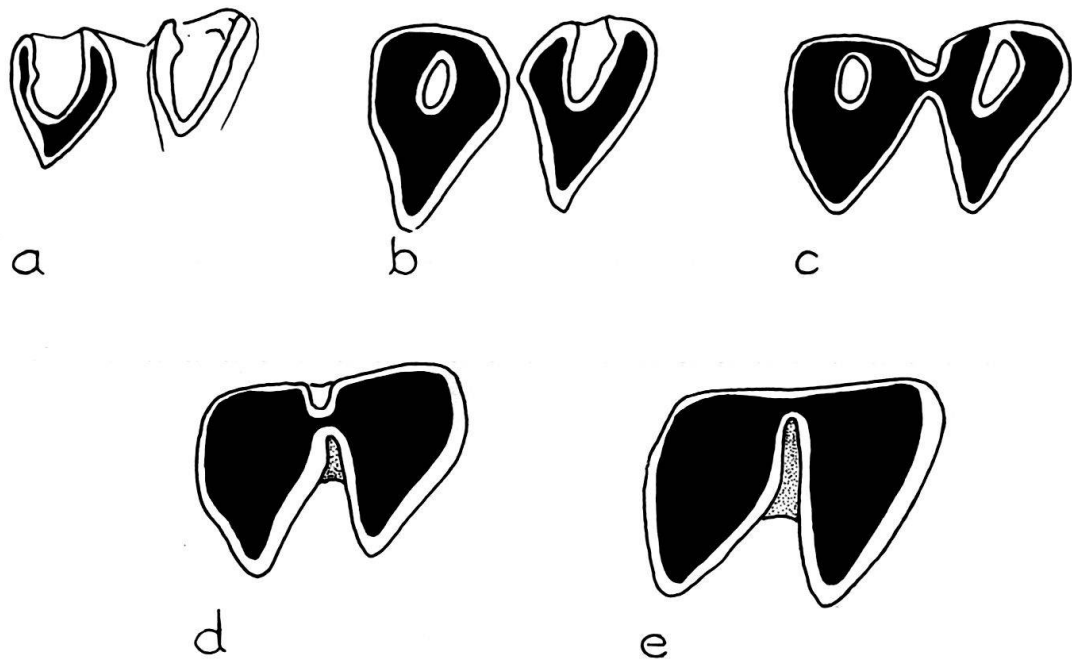

Fig. 5.1. Different stages of wear on lower teeth of *Issiodoromys*. a = SW-1. b = SW-2. c = SW-3. d = SW-4. e = SW-5.

lower enamel border of the crown is damaged or not visible at all. For this reason it is taken into account when establishing the quantitative boundaries among the 5 different stages of wear. This measure is used with the same name in the cases of semigraben, graben or pseudograben. In all genera of Theridomyinae and Issiodoromyinae this measure is taken from the both upper borders of the sinus on the occlusal surface down to the base. In *Archaeomys* genus, where in the worn stage the occlusal surface is very irregular due to asymmetrical excavation of dentine and cement between the enamel crest, one of the sinus borders is frequently very different in height. In spite of this, the measurement is taken as in Theridomyinae to better establish the difference among the different stages of wear (Fig. 4).

Sinusid height is the same measure as sinus height, but on the lower teeth.

Crown height is the extension of the measures above described, down toward the lower enamel border of the crown; oriented through the base of the sinus or the sinusid. In the case of *Archaeomys* and because of the difference with the measurements of the sinus or sinusid height, the measure is taken between the top of the enamel crest of the sinus, sinusid, graben, semigraben or pseudograben on the occlusal surface, down toward the lower enamel border of the crown (Fig. 4).

Lobule height: As well as in the anterior or posterior lobules as in the upper or lower teeth, the lobule height is measured between the lower end of the central cusp of enamel and the top of the enamel border of the lobules. For the orientation, this measure is taken from an imaginary line parallel to the occlusal surface, which must pass between the lower end of the central cusp of enamel and the anterior or posterior enamel border of the

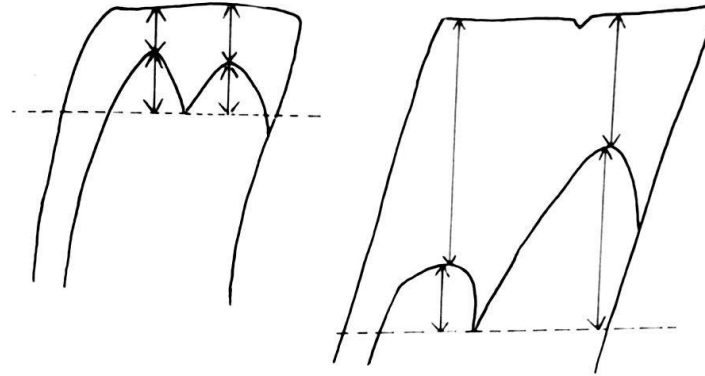

Fig. 6. Measurements of the lobule height and crown height above the lobules (explanation in the text).

measured lobule (Fig. 6) and then, from this imaginary line toward above the top of the enamel border of the lobule.

Crown height above the lobules is the measure of the crown height between the occlusal surface of the crown and the top of the border of the lobule. This measurement is applied to the anterior and posterior lobules in the upper and lower teeth (Fig. 6).

For the measurements of the crown curvature in Issidoromyinae, the method of TOBIEN (1974, p. 201, Fig. 94 and 1978, p. 169, Fig. 22) was followed. In the hypsodontic teeth, a series of circles with values for curvature radii from 1, 2 to 8 mm was used (Fig. 7). All measurements are given in mm.

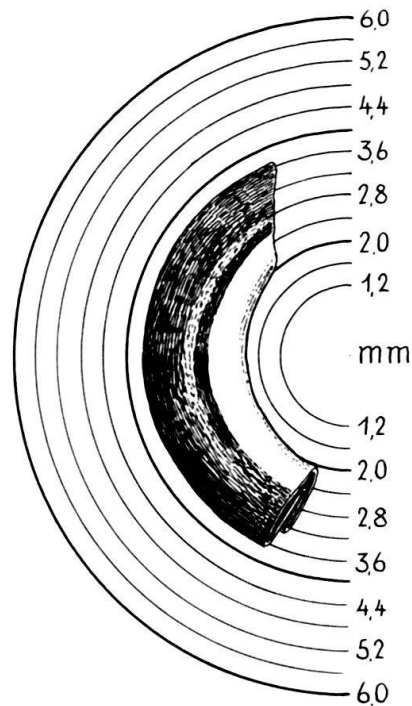

Fig. 7. Series of circles with values from 1, 2 to 6 mm for the measurements of the curvature radii on the lingual border of the hypsodontic teeth.

Abbreviations

| | |
|--------|---|
| BM(NH) | British Museum (Natural History), London, England. |
| BSM | Bayerische Staatssammlung für Paläontologie und Historische Geologie, München, West Germany. |
| IGJGUM | Institut für Geowissenschaften Johannes Gutenberg-Universität Mainz, West Germany. |
| KFSNMB | Kataster Fossiler Säugetiere, Naturhistorisches Museum, Basel (Register of Fossil Mammals of the Museum of Natural History of Basel). |
| LPVUM | Laboratoire de Paléontologie des Vertébrés, Université de Montpellier, France. |
| MGL | Musée géologique, Lausanne, Switzerland. |
| MHNL | Muséum d'Histoire naturelle, Lyon, France. |
| NMB | Naturhistorisches Museum, Basel, Switzerland. |
| NMBer | Naturhistorisches Museum, Bern, Switzerland. |
| NMO | Naturhistorisches Museum, Olten, Switzerland. |
| MNHNP | Muséum National d'Histoire Naturelle de Paris, France. |

For the teeth:

| | |
|----|------------------------------|
| e | – somewhat eroded tooth |
| f | – fragment of tooth |
| SW | – stage of wear of the teeth |

For the figures:

Foramina, fossas and fossetes:

| | |
|-------|--|
| aaf | – anterior alveolar foramen |
| demr | – dorsally external maxillary ridge or external crest of the infraorbital canal, ventral to the infraorbital foramen |
| dpf | – dorsal palatine foramen |
| etf | – ethmoid foramen |
| fml | – fossete for <i>M. masseter lateralis</i> |
| fms | – fossa or fossete for <i>M. masseter superficialis</i> |
| foioc | – fossa on the base of the infraorbital canal |
| if | – incisive foramen or foramina |
| inof | – interorbital fenestra |
| ioc | – infraorbital canal ventral to the infraorbital foramen |
| if | – infraorbital foramen |
| mf | – mental foramen |
| nlf | – nasolachrymal foramen |
| nf | – nutritive foramina |
| occh | – opened canal on the choanaes |
| owlc | – opening in the wall of lacrimal canal |
| pmf | – posterior maxillary foramen |
| pmn | – posterior maxillary notch |
| pmn+f | – posterior maxillary notch and foramen |
| ppf | – posterior palatine foramen |
| ptf | – pterygoid fossa |

Bones or teeth:

| | |
|-----|--------------|
| i | – incisive |
| f | – frontal |
| la | – lacrimal |
| mx | – maxilla |
| pmx | – premaxilla |
| pt | – pterygoid |

Family *Theridomyidae* ALSTON 1876Sub-Family *Theridomyinae* ALSTON 1876Genus *Isoptychus* POMEL 1854

Fig. 7-9

Synonymy. -

- 1848-52 *Theridomys* GERVAIS, p. 2, expl. to Fig. 6 und 7, Table 47, in part.
 1854 *Theridomys (Isoptychus)* POMEL, p. 34 und 35.
 1884 *Isoptychus* SCHLOSSER, p. 34.
 1891-93 *Theridomys (Isoptychus)* ZITTEL, p. 524.
 1898-99 *Theridomys* TROUSSART, p. 392.
 1904 *Theridomys (Isoptychus)* PALMER, p. 353.
 1941 *Trechomys (Isoptychus)* WINGE, p. 117, lapsus calami.
 1951 *Isoptychus* STEHLIN & SCHAUB, p. 37, 39 and 362.
 1952 *Theridomys (Isoptychus)* LAVOCAT, p. 50 and 76.
 1953 *Isoptychus* SCHAUB, p. 394.
 1958 *Theridomys (Isoptychus)* SCHAUB, p. 697.
 1966 *Isoptychus* THALER, p. 65, 66 and 67.
 1972 *Isoptychus* BOSMA & INSOLE, p. 137 and 138.
 1973 *Theridomys (Theridomys)* VIANEY-LIAUD, p. 299, in part.
 1974 *Isoptychus* BOSMA, p. 79.

Type species. - *Isoptychus aquatilis* (GERVAIS 1848-52).

Stratigraphic range. - Oligocene, Rupelien to Lower "Chattien", from *Isoptychus headonensis* zone to Oensingen assemblage zone (see ENGESSER & MAYO 1987).

Geographical distribution. - Central and West Europe.

Previous diagnoses. - POMEL (1854, p. 34-35); LAVOCAT (1952, p. 76); SCHAUB (1953, p. 14); SCHAUB (1958, p. 697-98); THALER (1966, p. 66); BOSMA & INSOLE (1972, 137-138) and BOSMA (1974, p. 79).

Emended diagnosis. - Theridomyinae of low to moderately high semi-hypsodonty, with thick borders of enamel in the antyclines and antyclinids. Maxilla very high in front of P⁴ but with lower height dorsally to M²-M³. Infraorbital canal very deep, not vaulted; with vertical external ridge and many foramina in its floor. Small anterior alveolar foramen at the base of the infraorbital canal. Small palatine vault, relatively wide and without grooves. Posterior border of incisive foramen in front of anterior half of P⁴. Choanaes opened in front of the anterior half of M³. Posterior palatine foramen in front of M². Posterior maxillary notch behind M³. Upper teeth with broad sinus and very broad I-III synclines from top to base. Small IV syncline and short sinus. I-III synclines equal or longer than sinus. Mandible: with relatively elevated mandibular ramus and strong angular process, but not more prolonged than condyloid process. Coronoid process more elevated than condyloid process and curved towards the back. Anterior border of coronoid process behind M₃ with a marked Temporalis crest. A strongly backwards inclined condyloid process with equal distance between the coronoid process and occlusal surface of the cheek teeth. Anterior masseteric shelflike ridge strong and inclined. Lower angular masseteric ridge very prominent. Shallow upper angular masseteric ridge. Lower teeth: P₄ with an entrant on the anterior border and one or two synclinids in the anterior part. M₁₋₃ with very broad sinusid and synclinids from top to base. Three synclinids equal or longer

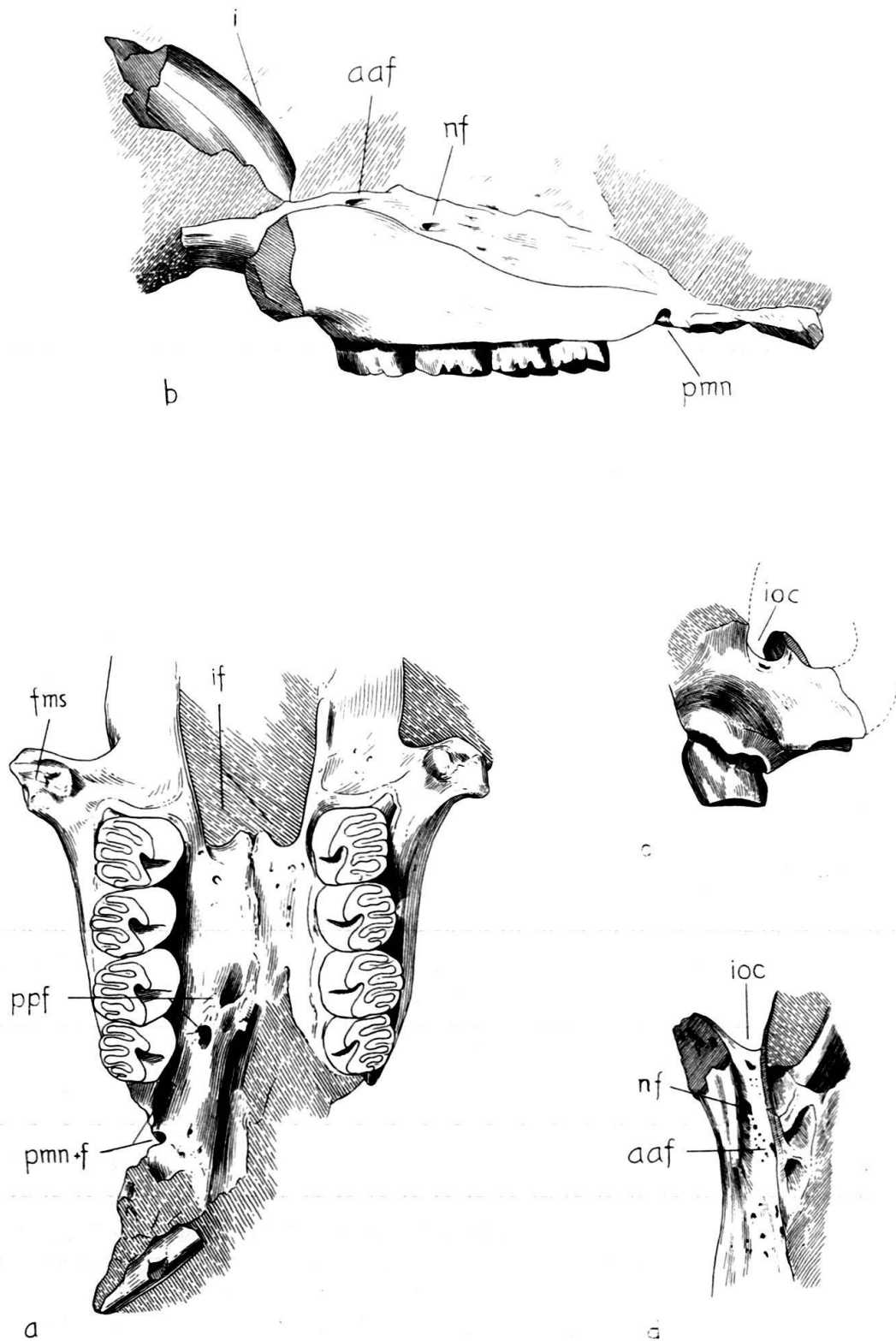

Fig. 8. *Isoptychus aquatilis* (GERVAIS 1848–52) NMB: Ro 57. Fragment of skull with teeth row (Ronzon, France). The specimen shows the typical characters of the genus *Isoptychus* POMEL 1854. a = ventral view. In the original specimen both maxillas are separated one from the other. b = lateral view of the left maxilla. c = frontal view of the left maxilla showing the deep infraorbital canal ventral to the infraorbital foramen. d = dorsal view of the infraorbital canal. – All figures $\times 4$.

than sinusid. Antyclines and antyclinids frequently with protuberances. Tendency to increase in size, semihypsodonty, maintenance of very broad synclines, synclinids, sinus and sinusids in all teeth and an anterior entrant in P₄.

Differential diagnosis. – *Isoptychus* differs from *Theridomys* JOURDAN 1837 in the following characters:

- smaller size,
- lower semihypsodonty,
- different morphology of maxilla,
- different infraorbital canal,
- dorsally higher external maxillary ridge of the infraorbital canal,
- many foramina in the base of the infraorbital canal,
- different longitude of palatine vault,
- different position of the posterior border of the incisive foramen,
- different position of the choanaes,
- different position of the posterior palatine foramen,
- different morphology of the upper teeth,
- shorter and broader sinus,
- smaller 5 antyline in P⁴,
- partial absence of 5 antyline in M³,
- very undeveloped 5 antyline in M¹ and M²,
- longer I, II and III synclines than sinus,
- partial absence of IV syncline in M³,
- smaller IV syncline in P⁴–M²,
- different morphology of the mandible,
- different morphology of the condyloid process,
- longer anterior masseteric ridge,

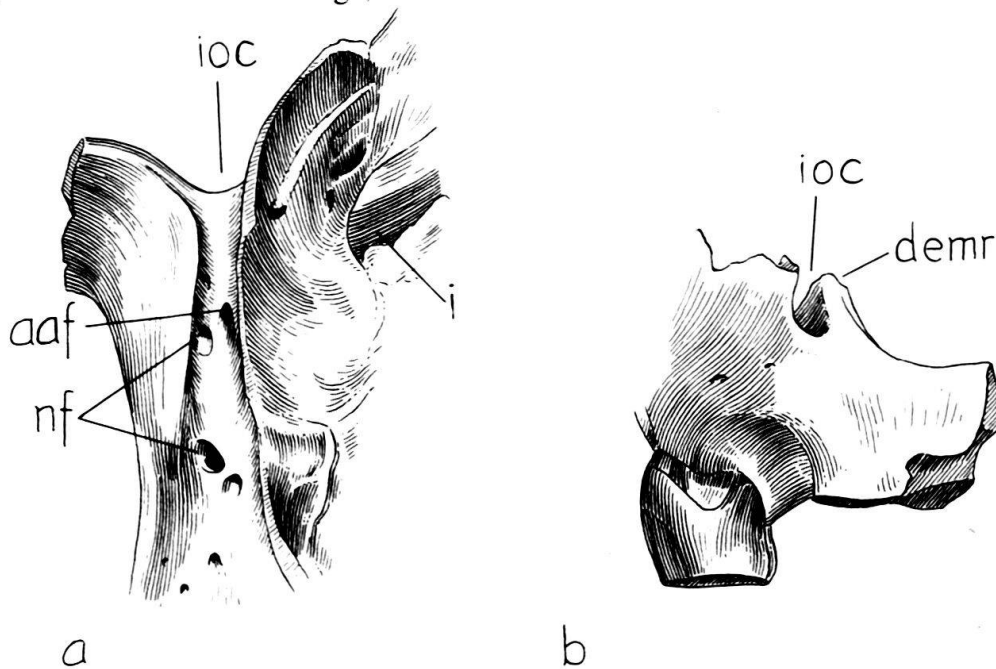
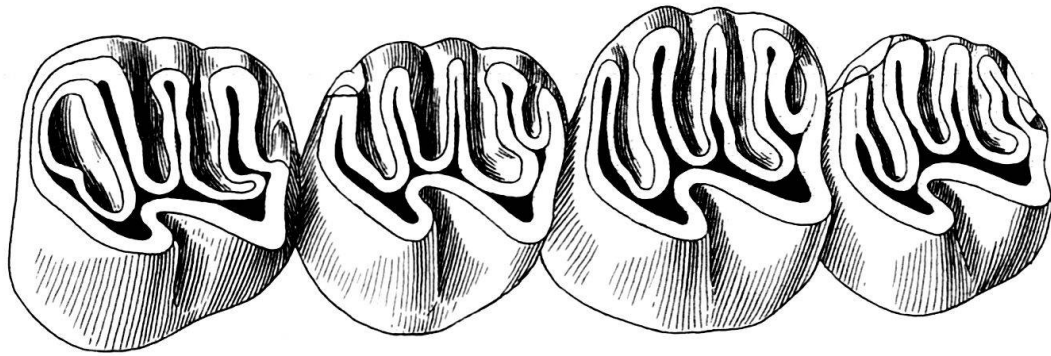
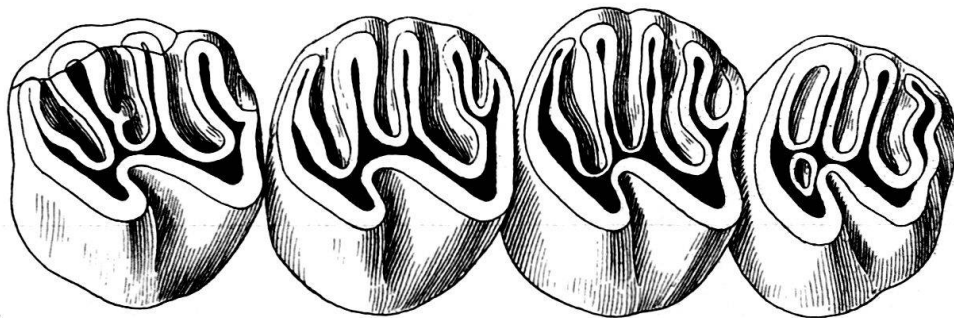

Fig. 9. *Isoptychus aquatilis* (GERVAIS 1848–52). NMB: Rz 57 Left maxilla. (Ronzon, France). a = dorsal view. Shown is the small intraspecific variations in the number of the nutritive foramina on the basis of the infraorbital canal and the position of the anterior alveolar foramen. b = frontal view. – × 6.

- different thickness of enamel in the incisor,
- different morphology of the lower teeth,
- absence of first antyclinid in P_4-M_3 ,
- absence of first synclinid in P_4-M_3 ,
- sinusid shorter than synclinids,
- broader sinusid,
- broader synclinids from top to base,
- frequent presence of protuberances or septums in upper and lower teeth.



c



b

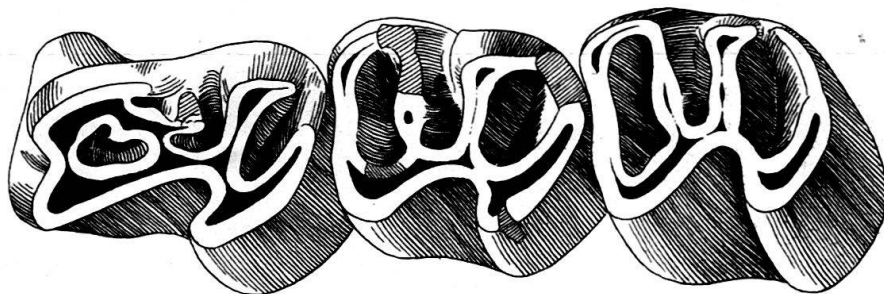

a

Fig. 10. *Isoptychus aquatilis* (GERVAIS 1848-52). a = BM(NH): M¹ 11605. P_4-M_2 sin. b = NMB: Rz 27. P^4-M^3 dex (invers.). c = NMB: Ro 57. P^4-M^3 dex (invers.). Ronzon, France. - All figures $\times 12,5$.

Discussion. – The discovery of *Isoptychus bumbachensis* n. sp. in an assemblage of very evolved genera and species shows clearly that the supposed line of evolution of “*Theridomys*” proposed by VIANEY-LIAUD (1973, p. 1007; 1973, p. 357, Fig. 27 and 1975, p. 769, Tab. 2) is very complex. VIANEY-LIAUD (1985, p. 172) described *Theridomys ludensis* and she stated that this species belongs to a second and different line of evolution to that represented by “*T. aquatilis* – *T. lembronicus*”. Nevertheless, MAYO (1982, p. 699) showed that the species of this supposed line are not successional species, because they have different generic characters. On the basis of the loss and acquisition of these characters, the relationship proposed by VIANEY-LIAUD is very improbable. MAYO (1986, p. 5, Fig. 1, in: ENGESSER et al.) illustrating different teeth, showed this taxon as a new subgenus of *Theridomys*. Now, I believe that *Theridomys* is a very evolved genus of Theridomyinae and probably has its origin in the genus *Trechomys* LARTET 1867. *Isoptychus* does not show a close relationship with *Theridomys* s. st. Therefore it is referred to as a separate genus with different successional species and two or three lines of evolution. One of these lines consists of larger species than the others. One of the lines with smaller species is *Isoptychus* (*Isoptychus*) subgenus. It is distinguishable by several subgeneric characters. The other line with smaller species is a new subgenus of *Isoptychus* to which belongs *Isoptychus ludensis*. The line with the large species, *I. bumbachensis* n. sp., I believe belongs to this new subgenus, but this matter is not completely clear at the moment (see MAYO 1987a).

Isoptychus bumbachensis n. sp.

Fig. II

Synonymy. –

1861 Nager ind. FISCHER, p. 222.

1914 *Theridomys* sp. I STEHLIN, p. 183.

1986 *Theridomys* (n. subg.) n. sp. MAYO, p. 5, Fig. 1, in: ENGESSER et al.

Derivatio nominis. – After Bumbach, type locality of the species.

Holotype. – NMB: Bum 101 (M^{1/2} sin.) in SW-3.

Measurements of the Holotype. – Sinus height: 1,50 · Length: 2,33 · Width: 2,33 · Sinus length: 0,92 · Extrasinus distance: 1,33 · Crown height: 2,00.

Paratypes. – SW-1. – NMB: UM 7023 (D₄ sin.); SW-2. – Bum 107 (M_{1/2} f dex.); SW-3. – NMB: Bum 104 (M^{1/2} sin.); NMB: Bum 105 (P₄ f sin.); 106 f and 108 f (M_{1/2} dex.); NMBer: Bu 30 (M₃ dex.); SW-4. – NMB: Bum 102 (M^{1/2} sin.) and 103 (M_{1/2} sin.).

Definition of the stage of wear. – Upper teeth: SW-1: unworn or almost unworn stages. SW-2: lightly worn. SW-3: some synclines opened. SW-4: all synclines closed. SW-5: very advanced worn stage. Sinus height very reduced. Lower teeth: as for upper teeth.

Type locality. – At the foot of Bumbach stream, Berner Oberland, Canton of Bern, Switzerland, (see KFSNMB).

Type formation. – Uerschli-Nagelfluh (Fluvial conglomerate of Uerschli). See HAUS 1937, p. 14 and 16; HABICHT 1987, p. 417.

Stratum type. – Red motley gray-blue marls with shell of mollusk, bone fragments and particles of lignite. At the foot of the riverside of Bumbach stream.

Stratigraphic range. – Oligocene, Lower “Chattien”, assemblage zone of Bumbach-1 (see ENGESSER & MAYO 1987).

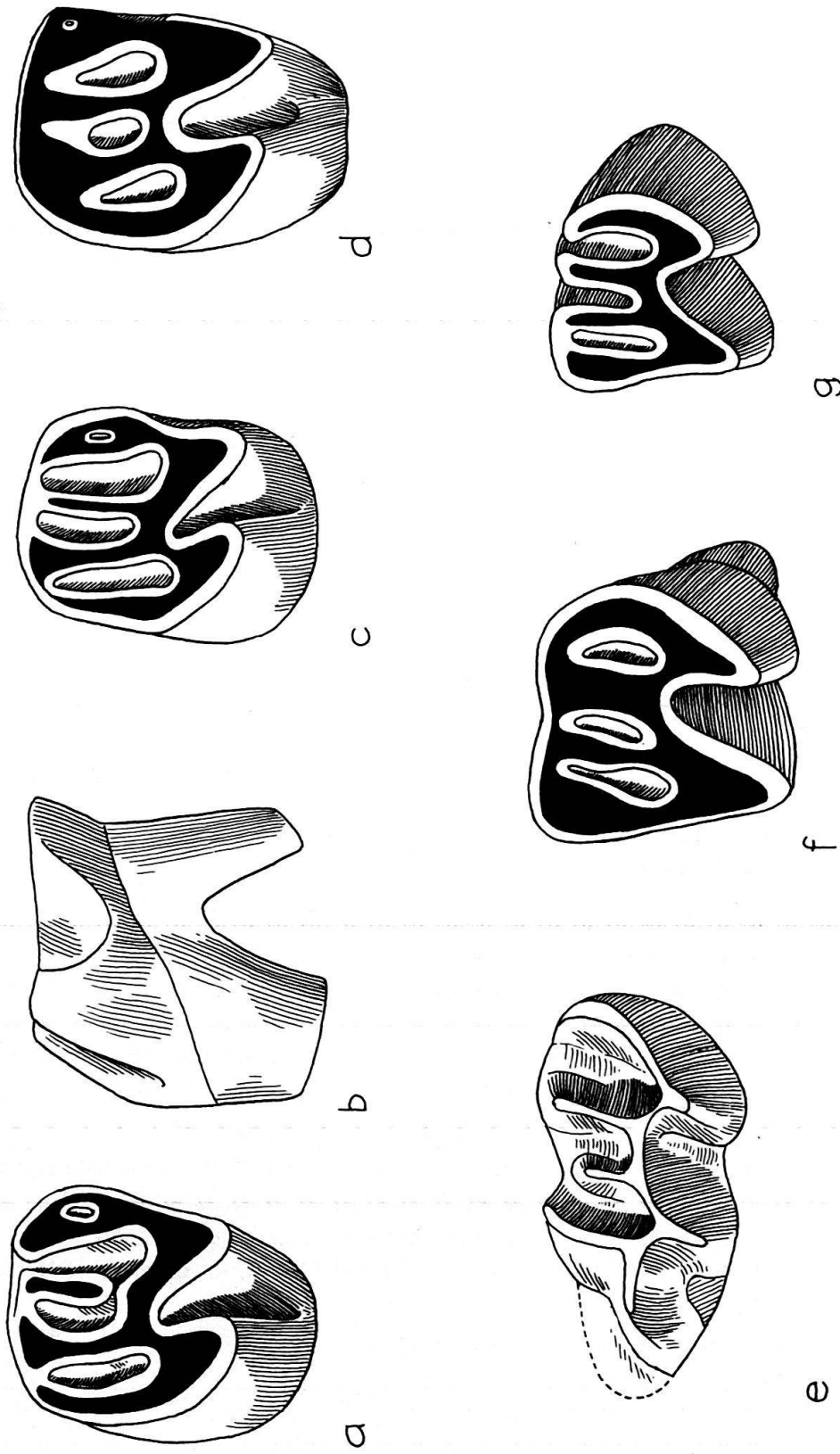

Fig. 11. *Isoptychus bumbachensis* n. sp. a = NMB: Bum 101. $M^{1/2}$ sin. Holotype. b = NMB: Bum 101 $M^{1/2}$ sin. Holotype. Posterior view. c = NMB: Bum 104. $M^{1/2}$ sin. Paratype. d = NMB: Bum 102. $M^{1/2}$ sin. Paratype. e = NMB: UM 7023. D_4 sin. Paratype. f = NMB: Bum 103. $M^{1/2}$ sin. Paratype. g = NMB: Bum 30 dex (invers.). Paratype. Bumbach 1, Switzerland. — All figures $\times 12,5$.

Geographical distribution. – Central Europe.

Diagnosis. – Species of large size and moderately high semihypsodonty. Very broad sinusids and sinus. Synclines and synclinids much broader from top to bottom. $M_{1/2}$ with or without joint between II and III synclines; 3 antycline completely or incompletely formed; P_4 with deep and wide anterior entrant. Poorly represented protuberances in synclines or synclinids.

Differential diagnosis. – *Isoptychus bumbachensis* n. sp. differs from *I. ludensis* in the:

- larger size,
- higher semihypsodonty,
- larger D_4 ,
- broader synclines and synclinids from top to bottom,
- poorly represented protuberances in synclines or synclinids,
- broader and deeper entrant on anterior border of P_4 .

Discussion. – The species *Isoptychus ludensis* (VIANEY-LIAUD 1985) was described on the basis of material found in the carstic fissure filling of Rigal-Jouet (Quercy). The comparison of the material of Bumbach-1 with the sample of Rigal-Jouet showed that the species at Bumbach-1 is larger and has a higher crown. MAYO (1986, p. 5, Fig. 1, in: ENGESSER et al.) considered the species *I. bumbachensis* n. sp. as belonging to a new subgenus of *Theridomys*. In Habach-5 (West Germany), a stratigraphical locality, the species *Isoptychus ludensis* (= *Theridomys ludensis*) was also found. Thanks to the kindness of J. Gad (Mainz) I have compared the material of Bumbach-I with a large

Table 1: Measurements of the cheek teeth of *Isoptychus bumbachensis* n. sp. from Bumbach 1 (Switzerland)

| Tooth | N | | range | \bar{X} | S | V |
|-----------|--------------|-----------------------|-----------|-----------|------|------|
| $M^{1/2}$ | 3 | Sinus height | 1,50–1,67 | 1,59 | 0,12 | 7,58 |
| | 3 | Length | 2,25–2,50 | 2,36 | 0,13 | 5,41 |
| | 3 | Width | 2,25–2,58 | 2,36 | 0,19 | 8,07 |
| | 3 | Sinus length | 0,83–1,00 | 0,88 | 0,06 | 7,27 |
| | 3 | Extrasinus distance | 1,25–1,50 | 1,39 | 0,13 | 9,19 |
| | 2 | Crown height | 1,92–2,17 | 2,05 | 0,18 | 8,64 |
| D_4 | 1 | Sinusid height | – | 1,17 | – | – |
| | 1 | Length | – | > 3,50 | – | – |
| | 1 | Width | – | 1,42 | – | – |
| | 1 | Sinusid length | – | 0,50 | – | – |
| | 1 | Extrasinusid distance | – | 0,83 | – | – |
| | 1 | Crown height | – | 1,58 | – | – |
| $M_{1/2}$ | 2 | Sinusid height | 1,00–1,08 | 1,04 | 0,06 | 5,44 |
| | 1 | Length | – | 2,50 | – | – |
| | 3 | Width | 2,08–2,67 | 2,59 | 0,12 | 4,65 |
| | – | Sinusid length | – | – | – | – |
| | 3 | Extrasinusid distance | 1,17–1,25 | 1,20 | 0,05 | 3,86 |
| 2 | Crown height | 1,50–2,25 | 1,88 | 0,53 | – | |
| M_3 | 1 | Sinusid height | – | 1,50 | – | – |
| | 1 | Length | – | 2,00 | – | – |
| | 1 | Width | – | 1,83 | – | – |
| | 1 | Sinusid length | – | 0,67 | – | – |
| | 1 | Extrasinusid distance | – | 1,00 | – | – |

sample of Habach-5. Also the species *I. bumbachensis* proved to be larger with a higher crown than the sample of Habach-5.

Measurements in the Table 1.

Genus *Blainvillimys* BRAVARD, in GERVAIS 1848–52
(sensu STEHLIN & SCHAUB 1951)

Synonymy. –

- 1848–52 *Blainvillimys* BRAVARD, in: GERVAIS, expl. Pl. 47, Fig. 18, p. 4, in part.
 1848–52 *Theridomys?* GERVAIS, expl. Pl. 47, Fig. 18, p. 4, in part.
 1855 *Blainvillimys* GIEBEL, p. 517, footnote.
 1884 *Theridomys* SCHLOSSER, p. 33 and 34, in part.
 1891–93 *Blainvillimys* ZITTEL, p. 524, in part.
 1898–99 *Blainvilleomys* TROUSSART, p. 392, misprint.
 1904 *Blainvillimys* PALMER, p. 137.
 1951 *Blainvillimys* STEHLIN & SCHAUB, p. 35, 36, 37, 213, 214, 216 and 362.
 1952 *Theridomys (Blainvillimys)* LAVOCAT, p. 77.
 1958 *Blainvillimys* SCHAUB, p. 698.
 1966 *Blainvillimys* THALER, p. 78.
 1973 *Theridomys (Blainvillimys)* VIANEY-LIAUD, p. 325.
 1979 *Archaeomys (Blainvillimys)* VIANEY-LIAUD, p. 205.
 1980 *Theridomys (Blainvillimys)* MAYO, p. 1103.
 1982 *Archaeomys (Blainvillimys)* VIANEY-LIAUD, p. 690 and 695, Fig. w/n.
 1982 *Blainvillimys* MAYO, p. 700, 703, 713, 714 and 715, Fig. 7.

Type species. – *Blainvillimys blainvillei* (GERVAIS 1848–52).

Stratigraphic range. – Lower and Middle Oligocene.

Geographical distribution. – Central and West Europe.

Previous diagnoses. – GERVAIS (1848–52, p. 4, explanation to Fig. 17–18, Plate 47); GIEBEL (1855, p. 517, footnote 2); PALMER (1904, p. 137); STEHLIN (1951, p. 35, in: STEHLIN & SCHAUB); SCHAUB (1951, p. 362, in: STEHLIN & SCHAUB); LAVOCAT (1952, p. 77); SCHAUB (1958, p. 698); THALER (1966, p. 57); VIANEY-LIAUD (1972, p. 1009 and 1973, p. 325–326).

Diagnosis. – Theridomyinae of low to medium semihypsodonty. Very fine enamel on the posterior border of the antyclines in the upper teeth and on the anterior border of the antyclinids in the lower ones. Maxilla with broad infraorbital foramen. Broad and moderate to very deep infraorbital canal. Fossa of anterior alveolar foramen in infraorbital canal with many nutritive foramina. Palatine vault longer than in *Toeniodus*. Posterior border of incisive foramen in front of sinus of P⁴. Choanaes open in front of posterior half of M². Posterior palatine foramen in front of anterior part of M². Open channel in choanaes. Upper teeth: with five antyclines and four synclines. Very thick enamel on anterior border of antyclines, crown and posterior border of sinus. Tubular to pseudolaminar synclines. Thick antyclines in unworn stage and moderately broad synclines. Sinus with tendency to increase in longitude and with labial end mostly between I and II synclines. Most of I synclines of greater or equal size than II in unworn stage. I syncline smaller than II, in advanced worn stage. III with slightly deeper labial and lingual apertures; I, II and IV tubular in worn stage. Mandible: with anterior border or coronoid process behind M₃ and inclined backwards. Condylod process marked above the occlusal surface of the cheek teeth. Anterior shelflike masseteric ridge below P₄ and

anterior part of M_1 . Angular lower ridge more prominent than upper. Anterior border of internal pterygoid fossa in front of anterior part of M_3 . Dental foramen below crown base. Lower teeth with or without I synclinid. I synclinid with a tendency to reduction. Sinusid with the tendency to increase in longitude by reduction of III synclinid. In the very evolved stage presence of a pseudograben or a shallow graben. II and IV synclinids longer than III. P_4 with a deeply opened III synclinid on the lingual border declining to a very shallow one. II without aperture to lingual border. Tubular to laminated synclinids.

Differential diagnoses. – *Blainvillimys* differs from *Toeniodus* in the following characters:

- different morphology of maxilla,
- longer palatine vault,
- absence of sulcus in palatine vault,
- different position of the posterior border of the incisive foramen,
- different morphology of the incisive foramen,
- different position of the aperture of the choanaes,
- different position of posterior palatine foramen,
- presence of posterior maxillary notch,
- presence of infraorbital canal,
- presence of fossa in the infraorbital canal,
- presence of many foramina in fossa of infraorbital canal,
- presence of external dorsal ridge in the maxilla,
- different morphology of D^4 ,
- thicker anterior border of enamel in antyclines of the upper teeth,
- thicker anterior border of enamel in the crown of upper teeth,
- thicker posterior border of enamel of the sinus in upper teeth,
- shorter length of sinus in the upper teeth,
- thicker antyclines and antyclinids of the teeth in unworn stage,
- more represented tubular synclines or synclinids on the teeth,
- different morphology of the mandible,
- different inclination of the anterior shelflike masseteric ridge,
- different position of the union between the anterior shelflike masseteric ridge and the upper angular masseteric ridge,
- different morphology of D_4 ,
- absence of deep fusion of the sinusid with IV synclinid,
- lower teeth without deep graben,
- rare occurrence of shallow pseudograben,
- pseudolaminar III synclinid in P_4 ,
- possible absence of I synclinid in unworn or slightly worn teeth.

From *Archaeomys* (n. subg.) or primitive Archaeomyids in the:

- different morphology of the maxilla,
- higher maxilla dorsally to M^2 – M^3 ,
- shorter palatine vault,
- different position of the posterior border of the incisive foramen,
- different position of the aperture of the choanaes,
- different position of posterior palatine foramen,

- absence of sulcus in palatine vault,
- presence of infraorbital canal,
- maxilla with fossa in association with the anterior alveolar foramen,
- presence of external dorsal ridge in the maxilla,
- different morphology of D⁴,
- lower semihypsodonty,
- thicker anterior border of enamel in the crown of upper teeth,
- shorter length of sinus in the upper teeth,
- more represented tubular synclines and synclinids,
- shorter synclines and synclinids,
- different morphology of the mandible,
- less inclined and lower position of the shelflike masseteric ridge,
- more marked upper angular masseteric sulcus,
- presence of upper angular masseteric ridge in contact with shelflike masseteric ridge,
- more strongly inclined lower border of angular process,
- different position of anterior border of internal pterygoid fossa,
- presence of a deep aperture in lingual border of III synclinid in most of P₄,
- absence of deep aperture in lingual border of II synclinid in P₄,
- absence of deep graben in lower teeth,
- presence of sinusid or shallow pseudogaben.

Blainvillimys blainvillei (GERVAIS 1848–52)

Fig. 12

Synonymy. –

- 1848–52 *Theridomys? blainvillei* GERVAIS, expl. Pl. 47, Fig. 18, p. 4.
 1898–99 *Theridomys blainvillei* THOUSSART, p. 392.
 1951 *Blainvillimys blainvillei* STEHLIN & SCHAUB, p. 362.
 1952 *Theridomys (Blainvillimys) blainvillei* LAVOCAT, p. 77, Pl. 13, Fig. 3.
 1965 *Blainvillimys blainvillei* THALER, p. 79.
 1966 *Blainvillimys blainvillei* THALER, p. 79, Pl. 9, Fig. b–c.
 1973 *Theridomys (Blainvillimys) blainvillei* VIANEY-LIAUD, p. 342, non p. 345, Fig. 24.
 1975 *Theridomys (Blainvillimys) blainvillei* BAHLO, p. 31.
 1979 *Archaeomys (Blainvillimys) blainvillei* VIANEY-LIAUD, p. 187, 201, 204, 205, 215, non 226, 227, nec 230? and 232, Fig. 57.
 1980 *Theridomys (Blainvillimys) blainvillei* MAYO, p. 1101, Fig. 7.
 1982 *Archaeomys (Blainvillimys) blainvillei* VIANEY-LIAUD, p. non 691, 692, in part 694 and 695.
 1982 *Blainvillimys blainvillei* MAYO, p. 703, Fig. 4, p. 704–705.

Neotype. – MNHNP: Lim 539 (M₁–M₃ dex.). All the teeth in SW-3. It is necessary to work out the taxonomic position of *B. blainvillei* (Art. 75 a Int. Code of Zool. Nom). The specimen figured by THALER 1966, Plate 9, Fig. a and b is designated as the Neotype (see STEHLIN & SCHAUB 1951, p. 35; LAVOCAT 1952, p. 77; VIANEY-LIAUD 1973, p. 342; and 1982, p. 692, Note 2; MAYO 1980, p. 1101, Note 2 and 1982, p. 704–705). MNHNP: Lim 538 was not the piece figured by THALER but MNHNP: Lim 539.

Measurements of the Neotype. – Sinusid height: M₁ = 1,28; M₂ = 1,48; M₃ = 1,00. Length: M₁ = 2,24; M₂ = 2,12; M₃ = 1,88. Width: M₁ = ?; M₂ = 2,04; M₃ = 1,72. Sinusid length: M₁ = ?; M₂ = 1,44; M₃ = 1,16. Extrasinusid distance: M₁ = 0,64; M₂ = 0,60;

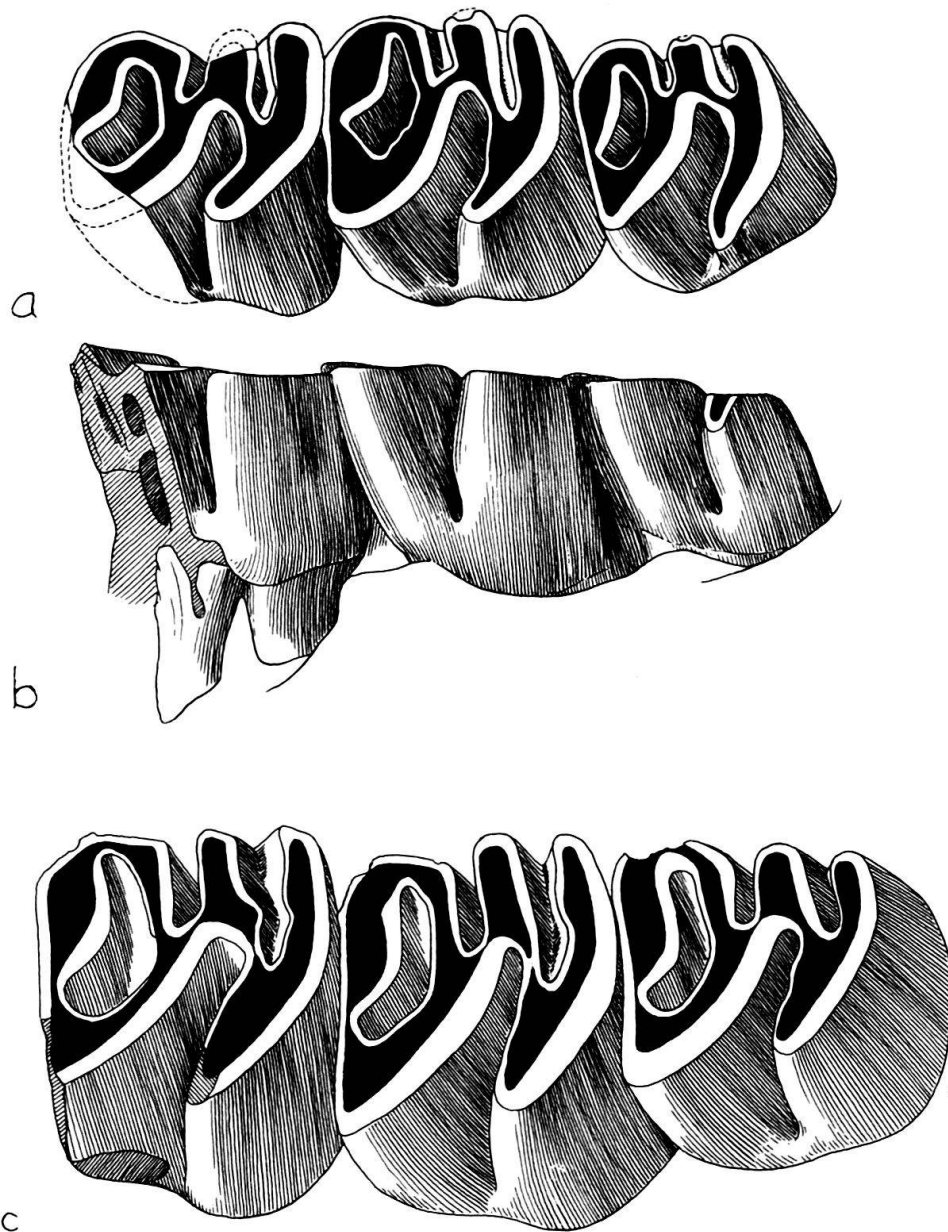

Fig. 12. *Blainvillimys blainvillei* (GERVAIS 1848–52). a = MNHNP: Lim 539. M_1 – M_3 dex (invers.). Neotype. Occlusal view. b = MNHNP: Lim 539. M_1 – M_3 dex (invers.). Neotype. Labial view. c = BM(NH): M 34932. M_1 – M_3 sin. Topotype. Antoingt, France. – All figures $\times 12,5$.

$M_3 = 0,44$: Crown height: $M_1 = ?$; $M_2 = 2,00$; $M_3 = ?$. Width/sinusid length ratio: $M_1 = ?$; $M_2 = 1,42$; $M_3 = 1,48$.

Topotypes. – SW-3. MNHNP: Lim 546 (M_2 – M_3 sin.); BM(NH): 34932 (M_1 – M_3 sin.):

Definition of the stage of wear. – Upper teeth: see new species of *Blainvillimys*. Lower teeth: SW-1: unworn or almost unworn stages. SW-2: II synclinid closed. SW-3: some synclinids opened. SW-4: all synclinids closed and with or without IV synclinid. SW-5: very advanced worn stage. Sinusid height very reduced.

Type locality. – Antoingt, France.

Table 2: Measurements of the lower teeth of *Blainvillimys blainvillei* from Antoingt (France)

| Tooth | N | | range | \bar{X} | S | V |
|------------------|---|-----------------------|-----------|-----------|------|-------|
| M _{1/2} | 3 | Sinus height | 1,33–1,50 | 1,42 | 0,09 | 6,00 |
| | 4 | Length | 2,12–2,40 | 2,28 | 0,13 | 5,55 |
| | 4 | Width | 2,00–2,20 | 2,09 | 0,09 | 4,24 |
| | 4 | Sinusid length | 1,40–1,52 | 1,47 | 0,06 | 3,76 |
| | 5 | Extrasinusid distance | 0,60–0,84 | 0,70 | 0,09 | 13,40 |
| | 4 | Crown height | 1,75–2,33 | 2,08 | 0,26 | 12,62 |
| M ₃ | 3 | Sinusid height | 1,33–1,50 | 1,16 | 0,21 | 18,25 |
| | 3 | Length | 1,88–2,25 | 2,02 | 0,20 | 10,07 |
| | 3 | Width | 1,72–2,08 | 1,85 | 0,20 | 10,65 |
| | 3 | Sinusid length | 1,16–1,20 | 1,17 | 0,02 | 1,97 |
| | 3 | Extrasinusid distance | 0,40–0,56 | 0,47 | 0,08 | 17,84 |
| | 2 | Crown height | 1,58–1,80 | 1,69 | 0,16 | 9,20 |

Other localities. – Romagnat, Saint-Vincent de Barbeyrargues, Sauvetat and Saint Yvoine (France).

Continental basins. – Auvergne and Languedoc (France).

Stratigraphic range. – Middle Oligocene, level of Antoingt.

Geographical distribution. – West Europe.

Diagnosis. – Species of moderately high semihypsodonty. P₄ with a very deep lingual aperture in III synclinid. P₄–M₃ with long sinusid but still with a deep and long tubular III synclinid. II and IV synclinids pseudolaminated. III smaller than IV. Very thick enamel on the anterior border of the sinusid and the posterior border of the crown. Means of width/sinusid length ratio 1,45.

Discussion. – Concerning the problem of the systematic position of *Blainvillimys blainvillei* there are enough explanation in the literature cited below by synonymy. The width/sinusid length ratio was measured on the specimens MNHNP: Lim 539, 546 and BM(NH): 34932.

Measurements in the Table 2.

Statistical test in the Tables 54 and 56.

Blainvillimys stehlini n. sp.

Fig. 13–14

Synonymy. –

- 1922 *Blainvillimys* sp. STEHLIN, p. 577.
- 1965 *Blainvillimys blainvillei* THALER, p. 118, in part.
- 1966 *Blainvillimys* aff. *blainvillei* THALER, 1966, p. 60 and 61, Table 4.
- 1966 *Blainvillimys blainvillei* THALER, p. 63, 79, 201, 203 and 243.
- 1973 primitive *Archaeomys* HÜRZELER, in: RUTSCH & SCHLÜCHTER, Table 1.
- 1973 *Theridomys (Blainvillimys) blainvillei* VIANEY-LIAUD, p. 342 and 345.
- 1975 *Theridomys (Blainvillimys) blainvillei* BÄHLO, p. 160, footnote 7.
- 1976 *Theridomys (Blainvillimys) blainvillei* VIANEY-LIAUD, p. 59.
- 1979 *Archaeomys (Blainvillimys) blainvillei* VIANEY-LIAUD, p. 230.
- 1980 *Archaeomys* n. sp. MAYO, p. 1100 and 1102, Fig. 2 and 4.
- 1982 *Archaeomys (Blainvillimys) blainvillei* VIANEY-LIAUD, p. 691 and 692, Fig. w/n.
- 1982 *Archaeomys (Blainvillimys) blainvillei* évolué VIANEY-LIAUD, p. 694 and 695.
- 1982 *Archaeomys* cf. *gervaisi* VIANEY-LIAUD, p. 691, in part.

1982 *Archaeomys gervaisi* plus évolué VIANEY-LIAUD, p. 692, in part.

1982 *Blainvillimys* n. sp. MAYO, 1982, p. 703, 714 and 715, Fig. 6 and 7.

Derivatio nominis. – After Dr. H. G. Stehlin (1870–1941), Basel.

Holotype. – NMB: UM 2402 (P_4 – M_2 sin.) P_4 in SW-3 and M_1 – M_2 in SW-4.

Measurements of the Holotype. – sinusid height: $P_4 = 1,75$; $M_1 = 1,40$; $M_2 = 1,24$. Length: $P_4 = 3,17$; $M_1 = 2,33$; $M_2 = 2,33$. Width: $P_4 = 1,75$; $M_1 = 2,08$; $M_2 = 2,17$. Sinusid length: $P_4 = 1,69$; $M_1 = 1,83$; $M_2 = 1,83$. Extrasinusid distance: $P_4 = 0,12$; $M_1 = 0,22$; $M_2 = 0,22$. Crown height: $P_4 = 2,42$; $M_1 = 2,58$; $M_2 = 2,04$. Width/sinusid length ratio: $P_4 = 0,59$; $M_1 = 1,14$; $M_2 = 1,19$.

Paratypes. – All the specimens in NMB. D^4 : MH-8. SW-1. – P^4 : Mü 56. $M^{1/2}$: UM 2384f. P_4 : UM 2417. $M^{1/2}$: UM 2424f. SW-2. – P^4 : UM 2374. P_4 : UM 2407 SW-3. – P^4 : UM 2372. $M^{1/2}$: Mü 55f; UM 2377f. M^3 : MH: 5. P_4 : UM; 2405 and 2418(e). M_3 : Mü 31. SW 4. – P^4 : MH-7; UM 2370. $M^{1/2}$: UM 2379; 2381; 2392; MH: 9–10. M^3 : UM 2362; 2378; 2385; 2389 and Mü 29. P_4 : UM 2425 and 2438a. $M^{1/2}$: UM 2375; 2380; 2383; 2399; 2408 and 2412. SW-5. – M_3 : UM 2420. Maxillary fragments: UM 2355 (M^1 – M^3 in SW-4). Mandibular fragments: UM 2398 (P_4 – M_1 in SW-4). UM 2400 (P_4 – M_1 in SW-4).

Table 3: Measurements of the P^4 of *Blainvillimys stehlini* n. sp. from Mümliswil–Hardberg (Switzerland)

| SW | N | Sinus height | Length | Width | Sinus length | Extrasinus distance | Crown height |
|----|---|--------------|-----------|-------|--------------|---------------------|--------------|
| 1 | 1 | 2,92 | 2,33 | 1,60 | 0,83 | 0,68 | 4,00 |
| 2 | 1 | 2,83 | 2,25 | 1,67 | 0,68 | 0,68 | 3,50 |
| 3 | 1 | 2,17 | 2,58 | 2,33 | 1,33 | 0,60 | 3,08 |
| 4 | 2 | 1,67–1,83 | 2,33–2,83 | – | 1,28–1,75 | – | 2,08–2,50 |
| 5 | 1 | 0,92 | 2,33 | 2,42 | 1,67 | 0,76 | 1,67 |



Fig. 13. *Blainvillimys stehlini* n. sp. a = NMB: UM 2402. P_4 – M_2 sin. Holotype. b = NMB: UM 2402. P_4 sin. Holotype. Lingual view of the P_4 for to see the absence of the aperture in the III synclinid. Mümliswil–Hardberg, Switzerland. – $\times 12,5$.

Table 4: Measurements of the M^{1/2} of *Blainvillimys stehlini* n. sp. from Mümliswil–Hardberg (Switzerland)

| SW | N | | range | \bar{X} | S | V |
|----|---|---------------------|-----------|-----------|------|-------|
| 3 | 2 | Sinus height | 2,42–2,58 | 2,50 | 0,11 | 4,53 |
| | 2 | Length | 1,67–1,83 | 1,75 | 0,12 | 6,46 |
| | 2 | Width | 1,67–1,83 | 1,75 | 0,12 | 6,46 |
| | 2 | Sinus length | 1,28–1,33 | 1,30 | 0,35 | 2,70 |
| | 2 | Extrasinus distance | 0,48–0,52 | 0,50 | 0,03 | 5,66 |
| | 2 | Crown height | 3,00–3,08 | 3,04 | 0,06 | 1,86 |
| 4 | 7 | Sinus height | 0,75–2,25 | 1,56 | 0,46 | – |
| | 6 | Length | 2,17–2,33 | 2,22 | 0,04 | 2,94 |
| | 4 | Width | 2,17–2,50 | 2,31 | 0,14 | 6,10 |
| | 7 | Sinus length | 1,25–2,00 | 1,59 | 0,24 | 15,51 |
| | 6 | Extrasinus distance | 0,52–0,68 | 0,63 | 0,06 | 9,61 |
| | 7 | Crown height | 1,75–2,67 | 2,24 | 0,34 | 15,47 |

Definition of the stage of wear. – Upper teeth: SW-1: unworn or almost unworn stage. SW-2: lightly worn. SW-3: III syncline opened. SW-4: III syncline closed and with or without IV syncline. SW-5: very advanced worn stage. Sinus height very reduced. Lower teeth: equal to *B. blainvillei*.

Hypodigm. – Besides Holotype and Paratypes the following specimen: NMB Mü 32 (P⁴) in SW-5.

Type locality. – Mümliswil–Hardberg = Mümliswil–Heitersberg, Canton of Solothurn, Switzerland (see BAUMBERGER 1923, p. 71–72, Fig. 25, 26; MAYO 1980, p. 1096–97, Fig. 1 and 1982, p. 714–718, Fig. 8, 9 and KFSNMB).

Type formation. – Matzendörfer Kalke (Matzendorf limestone). See BAUMBERGER 1927, p. 550; WAIBEL & BURRI 1961, p. 166–67; MAYO 1980, p. 1096–97 and HABICHT 1987, p. 10.

Stratum type. – Gray-cream marls with concretions and shells of mollusk. Thickness 15–30 cm.

Stratigraphic range. – Oligocene, Lower “Chattien”, assemblage zone of Mümliswil–Hardberg (see ENGESSER & MAYO 1987).

Geographical distribution. – Central Europe.

Table 5: Measurements of the M³ of *Blainvillimys stehlini* from Mümliswil–Hardberg (Switzerland)

| SW | N | | range | \bar{X} | S | V |
|----|---|---------------------|-----------|-----------|------|-------|
| 3 | 1 | Sinus height | – | 1,83 | – | – |
| | 1 | Length | – | – | – | – |
| | 1 | Width | – | 2,00 | – | – |
| | 1 | Sinus length | – | 1,33 | – | – |
| | 1 | Extrasinus distance | – | 0,68 | – | – |
| | 1 | Crown height | – | 2,33 | – | – |
| 4 | 5 | Sinus height | 1,00–1,75 | 1,44 | 0,29 | – |
| | 5 | Length | 1,92–2,33 | 2,14 | 0,18 | 8,31 |
| | 5 | Width | 1,75–2,08 | 1,96 | 0,14 | 7,01 |
| | 4 | Sinus length | 1,42–1,58 | 1,53 | 0,08 | 4,95 |
| | 5 | Extrasinus distance | 0,44–0,60 | 0,51 | 0,07 | 12,84 |
| | 5 | Crown height | 1,33–2,50 | 1,98 | 0,47 | – |

Diagnosis. Height of maxilla anterior to P⁴ low, and dorsally to P⁴ higher. Slightly deep infraorbital canal, with wide and shallow fossa. Moderately high semihypsodontic teeth. P⁴–M³ with narrow sinus, and more prolonged than the middle part of the occlusal surface. Synclines: I and II pseudolaminated and very reduced. Mandible: small, slightly inclined and moderately protuberant anterior shelflike masseteric below P₄. Very well marked upper angular masseteric ridge and relative deep sulcus. Most of P₄–M₃ with graben or semigraben; rarely with pseudograben and long sinusid. Without tubular III synclinid. II and IV synclinid laminated and shallowly opened on lingual crown border. I synclinid no represented. M_{1/2} slightly longer than wide. Means of width/sinusid length ratio: 1,16.

Table 6: Measurements of the P₄ of *Blainvillimys stehlini* n. sp. from Mümliswil–Hardberg (Switzerland)

| SW | N | | range | \bar{X} | S | V |
|----|---|-----------------------|-----------|-----------|------|-------|
| 3 | 2 | Sinusid height | 1,75–2,00 | 1,88 | 0,17 | 9,43 |
| | 2 | Length | 3,00–3,17 | 3,09 | 0,12 | 3,90 |
| | 2 | Width | 1,75–1,88 | 1,82 | 0,09 | 5,06 |
| | 2 | Sinusid length | 1,50–1,69 | 1,60 | 0,13 | 8,42 |
| | 2 | Extrasinusid distance | 0,12–0,20 | 0,16 | 0,06 | – |
| | 2 | Crown height | 2,42–2,92 | 2,67 | 0,35 | 13,24 |
| 4 | 4 | Sinusid height | 0,58–2,83 | 1,42 | 0,98 | – |
| | 3 | Length | 2,50–3,25 | 2,92 | 0,38 | 13,09 |
| | 4 | Width | 1,33–2,00 | 1,77 | 0,30 | 17,03 |
| | 4 | Sinusid length | 1,25–1,92 | 1,73 | 0,32 | 18,62 |
| | 2 | Extrasinusid distance | 0,12–0,15 | 0,14 | 0,21 | 15,71 |
| | 4 | Crown height | 1,50–2,17 | 1,88 | 0,29 | 15,25 |

Differential diagnosis. – *Blainvillimys stehlini* n. sp. differs from *B. blainvillei* in the following characters:

- higher semihypsodonty,
- absence of tubular III synclinid,
- longer and laminated synclinids,
- III synclinid rare and only like a shallow notch,
- presence of graben or pseudograben in lower teeth,
- long semigraben,
- absence of real sinusid,
- absence of deep aperture in III synclinid of P₄,
- shorter extrasinusid distance,
- different width/sinusid length ratio.

Discussion. – STEHLIN (1922, p. 577) mentioned the presence of *Blainvillimys* sp. in Mümliswil–Hardberg. The specimen NMB: UM 2355 (M¹–M³) and UM 2402 (P₄–M₂ Holotype) were referred by THALER (1966, p. 60, Tabl. 4) and VIANEY-LIAUD (1973, p. 345, Fig. 24) to *Blainvillimys blainvillei*. The last author also referred the tooth NMB: Mü 31 (M₃) of Mümliswil–Hardberg (non Mümliswil–Näsühöfli as she wrote) to this species. Later, VIANEY-LIAUD (1982, p. 691–695, Fig. w/n) figured again the specimen NMB: UM 2402 as an evolved *B. blainvillei*. MAYÖ (1980, p. 1100, 1102, Fig. 2 and 4; and 1982, p. 713,

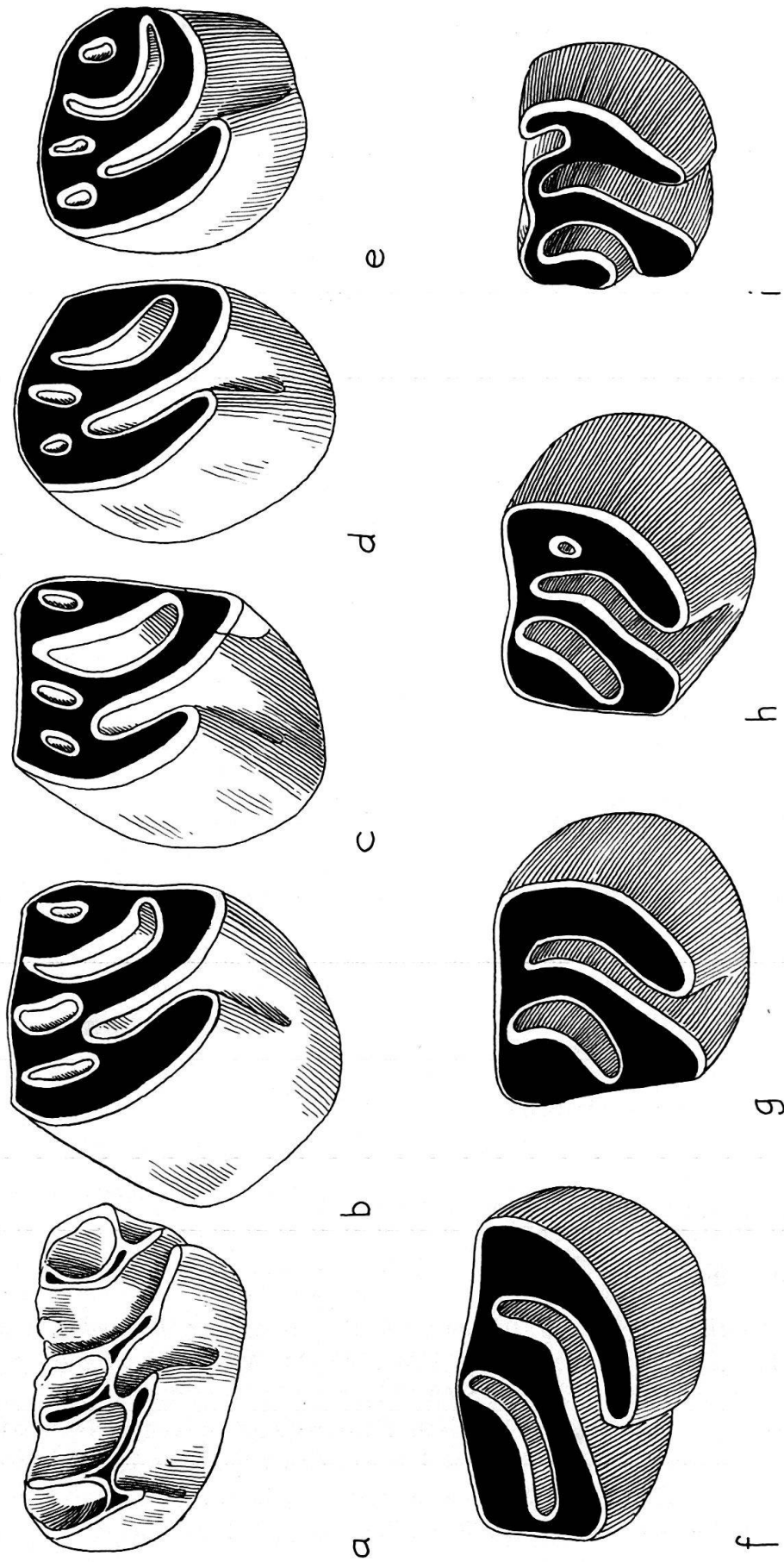

Fig. 14. *Blainvillimys stehlini* n. sp. a = NMB: MH 8. D⁴ dex (invers.). b = NMB: UM 2372. P⁴ dex (invers.). c = NMB: UM 2392. M¹ dex (invers.). d = NMB: UM 2391. M² dex (invers.). e = NMB: UM 2378. M³ sin. f = NMB: UM 2425 dex (invers.). g = NMB: UM 2375. M_{1/2} dex (invers.). h = NMB: UM 2389 M_{1/2} dex (invers.). i = NMB: Mü 33. M₃ dex (invers.). Paratypes. Mümliswil-Hardberg, Switzerland. — All figures × 12.5.

Table 7: Measurements of the $M_{1/2}$ of *Blainvillimys stehlini* n. sp. from Mümliswil–Hardberg (Switzerland)

| SW | N | | range | \bar{X} | S | V |
|----|----|-----------------------|-----------|-----------|------|-------|
| 4 | 10 | Sinusid height | 0,50–1,75 | 1,24 | 0,41 | – |
| | 9 | Length | 2,17–2,58 | 2,31 | 0,13 | 5,56 |
| | 9 | Width | 2,00–2,42 | 2,13 | 0,13 | 6,57 |
| | 8 | Sinusid length | 1,67–2,20 | 1,83 | 0,16 | 8,79 |
| | 9 | Extrasinusid distance | 0,16–0,28 | 0,21 | 0,03 | 15,06 |
| | 9 | Crown height | 1,33–2,75 | 2,01 | 0,56 | – |

715, Fig. 6 and 7) considered the material of *Blainvillimys* of Mümliswil–Hardberg as a new species: first as the genus *Archaeomys*, afterwards as *Blainvillimys*. The specimen NMB: UM 2407 (P_4 sin.) and UM 2424 (unworn fragment of $M_{1/2}$) show a very superficial pseudograben, where the III synclinid is only a slight notch. But, no one specimen shows a typical tubular III synclinid. Ninety six percent of the lower teeth show a graben or semigraben (none a sinusid with a tubular III synclinid). In the process of wear this rare pseudograben shows a longer “sinusid” with a wide notch on the lingual border. The Pearson variation coefficient of the length of $M_{1/2}$ (9 specimens) show a normal value of V (5,56), in spite of the few number of specimens. The comparison by the Student t-test of the sample of *Blainvillimys blainvillei* of Antoingt (4 specimens) with the sample of *B. stehlini* n. sp. of Mümliswil–Hardberg (8 specimens) for the length of $M_{1/2}$ did not show significant differences. But the Student t-test show highly significant differences for sinusid length (N = 11) and for the width/sinusid length ratio (N = 12).

Measurements in the Tables 3–8.

Statistical test in the Tables 54 and 56.

Table 8: Measurements of the M_3 of *Blainvillimys stehlini* n. sp. from Mümliswil–Hardberg (Switzerland)

| SW | N | Sinusid length | Length | Width | Sinusid length | Extrasinusid distance | Crown height |
|----|---|----------------|--------|-------|----------------|-----------------------|--------------|
| 3 | 1 | 1,08 | 1,92 | 1,83 | 1,50 | 0,17 | 1,75 |
| 5 | 1 | 0,42 | 2,17 | 2,00 | 1,92 | 0,17 | 0,58 |

Subfamily *Issiodoromyinae* (SCHLOSSER 1884)

Genus *Issiodoromys* CROIZET, in BLAINVILLE 1840

Type species. – *Issiodoromys pseudanema* GERVAIS 1848–52.

Stratigraphic range. – Oligocene, Upper “Chattien”. From Fornant-7 to Rickenbach assemblage zones in the faunal province of Switzerland and Savoy (see ENGESSER & MAYO 1987).

Geographical distribution. – Central and West Europe.

Previous diagnoses. – CROIZET 1840, in: BLAINVILLE, p. 931–32; GERVAIS 1848–52, p. 27 and 47, explanation to Fig. 6 and 8; POMEL 1854, p. 39–40; LYDEKKER 1885, p. 252; ZITTEL 1891–93, p. 525; VIRET 1929, p. 85; WINGE 1941, p. 22–23 and 131; FREUDENBERG 1941, p. 137; STEHLIN 1951, p. 69, 74 and 247–48 in: STEHLIN & SCHAUB; SCHAUB 1953, p. 190 and 1958, p. 45; VIANEY-LIAUD 1976, p. 34.

Emended diagnosis. – Hypsodont [protohypsodont] Issiodoromyinae. Broad infraorbital foramen. Ascending ramus of anterior zygomatic process with very concave anterior

border. Masseteric apophysis of the anterior zygomatic process with masseteric ridge and horizontal foramen laterally to the ridge. External alveolar border of the maxilla in front of M^2 – M^3 , perpendicular to the abrasive surface of the teeth. Mandible with very elongated longitudinal masseteric ridge and deep tubular masseteric sulcus. Teeth with very elongated lobules. P^4 with normal to atrophied anterior labial root. M^1 – M^2 with atrophied labial roots. M^3 with semiatrophied labial roots. Enamel in the labial border of the upper teeth or in the lingual of the lower ones reduced or missing in the lobules. Lower teeth with two or three roots.

Subgenus *Issiodoromys* (*Issiodoromys*) CROIZET

Issiodoromys (*Saboyanomys*) n. subg.

Issiodoromys (*Issiodoromys*) CROIZET, in BLAINVILLE 1840

Type species. – *I. (Issiodoromys) pseudanema* GERVAIS 1848–52.

Stratigraphic range. – Oligocene, Upper “Chattien”. Upper the Fornant-6 to Rickenbach assemblage zones, in faunal province of Switzerland and Savoy (see ENGESSER & MAYO 1987).

Geographical distribution. – Central and West Europe.

Diagnosis. – Issiodoromyinae without enamel in the lobules on the labial border of the crown in the upper teeth or on the lingual border of the lowers. Lower border of the anterior zygomatic process with short and narrow masseteric apophysis and ridge. Maxilla with broad infraorbital canal on the base, strongly vaulted and with a highly developed external ridge. Anterior alveolar foramen in the base of the infraorbital canal. Posterior border of incisive foramen in front of the posterior prism of P^4 . P^4 smaller than M^1 or M^2 and very inclined to M^1 – M^3 . Most of the I syncline in P^4 opened. Crown of P^4 – M^3 : quadrangular in SW-1 to 3; subcylindrical starting from SW-4. Sinus rectum, blunt, short and broad in P^4 – M^3 in SW-3. In M^1 – M^3 sinus very elongated, curved and sharp starting from SW-4. All teeth with sinus and sinusid, open lingually and labially respectively and closed inside by cellular cement. M^1 – M^2 with atrophied labial roots. P^4 with normal to semiatrophied anterior labial root. Lingual root with narrow base. M^3 with two semiatrophied labial roots or only one posterior semiatrophied labial root, somewhat laminated. Lower teeth with long roots without indication of atrophy.

I. (Saboyanomys) n. subg.

Type species. – *I. (Saboyanomys) weidmanni* n. subg. n. sp.

Stratigraphic range. – Oligocene, Upper “Chattien”, from Fornant-7 to Rickenbach assemblage zones (see ENGESSER & MAYO 1987).

Geographical distribution. – Central and West Europe.

Diagnosis. – Issiodoromyinae with fine enamel layer on the lobules of the crown in the upper teeth and partially on the lower. Lobules of medium size on the labial border of the upper teeth and on the lingual border of the lower. Maxilla with broad and scarcely vaulted infraorbital canal. External ridge slightly developed. Small maxillary height from the labial alveolar border to the dorsal border of the external ridge. Posterior border of

Table 9: Measurements of the P⁴ of *Issiodoromys (Saboyanomys) weidmanni* n. subg. n. sp. from Ruisseau du Bey (Switzerland)

| SW | N | | range | \bar{X} | S | V |
|----|---|--------------|-----------|-----------|------|-------|
| 1 | 3 | Length | 1,58–2,00 | 1,72 | 0,24 | 14,10 |
| | 2 | Width | 1,25–1,42 | 1,34 | 0,12 | 9,00 |
| 3 | 3 | Sinus height | 3,87–4,33 | 4,07 | 0,24 | 5,83 |
| | 5 | Length | 1,60–1,83 | 1,71 | 0,09 | 5,05 |
| | 5 | Width | 1,48–1,68 | 1,58 | 0,09 | 5,87 |
| | 3 | Crown height | 4,17–4,75 | 4,42 | 0,30 | 6,78 |
| 4 | 6 | Sinus height | 2,83–4,17 | 3,57 | 0,54 | 15,04 |
| | 7 | Length | 1,67–1,83 | 1,74 | 0,06 | 3,20 |
| | 7 | Width | 1,50–1,83 | 1,69 | 0,11 | 6,79 |
| | 6 | Crown height | 3,17–4,50 | 3,88 | 0,51 | 13,26 |
| 5 | 3 | Sinus length | 1,83–3,08 | 2,61 | 0,68 | – |
| | 4 | Length | 1,58–1,75 | 1,71 | 0,09 | 4,98 |
| | 4 | Width | 1,33–2,58 | 1,77 | 0,56 | – |
| | 3 | Crown height | 2,17–3,67 | 3,00 | 0,76 | – |

the incisive foramen in front of the posterior prism of P⁴. P⁴ slightly smaller than M¹ or M²; very inclined toward M¹–M² and with semiatrophied to vestigial anterior labial roots, according to species. I syncline of P⁴ closed. M¹–M³ with two atrophied to vestigial roots. P⁴–M³ with lingual root slightly broader than crown cylinder and with the tendency to reduction. Lower teeth lingually concave towards the middle of the crown and with a tendency toward atrophy in the roots.

Differential diagnosis. – *I. (Saboyanomys)* n. subg. differs from *I. (Issiodoromys)* in the following characters:

Table 10: Measurements of the M^{1/2} of *Issiodoromys (Saboyanomys) weidmanni* n. subg. n. sp. from Ruisseau du Bey (Switzerland)

| SW | N | | range | \bar{X} | S | V |
|----|---|--------------|-----------|-----------|------|-------|
| 1 | 1 | Length | – | 1,90 | – | – |
| | 1 | Width | – | 1,17 | – | – |
| 2 | 1 | Sinus height | – | 4,75 | – | – |
| | 2 | Length | 1,75–1,92 | 1,84 | – | – |
| | 2 | Width | 1,42–1,50 | 1,46 | – | – |
| 3 | 1 | Sinus height | – | 5,50 | – | – |
| | 3 | Length | 1,75–2,08 | 1,86 | 0,19 | 10,24 |
| | 3 | Width | 1,33–1,67 | 1,47 | 0,18 | 11,96 |
| | 1 | Crown height | – | 5,83 | – | – |
| 4 | 8 | Sinus height | 4,33–6,00 | 5,36 | 0,55 | 10,31 |
| | 9 | Length | 1,75–2,08 | 1,89 | 0,11 | 5,83 |
| | 8 | Width | 1,33–1,83 | 1,59 | 0,20 | 12,27 |
| | 5 | Crown height | 5,41–6,25 | 5,87 | 0,39 | 6,60 |
| 5 | 9 | Sinus height | 1,75–4,58 | 3,57 | 0,48 | – |
| | 9 | Length | 1,58–1,92 | 1,78 | 0,09 | 5,37 |
| | 8 | Width | 1,50–2,08 | 1,81 | 0,18 | 9,72 |
| | 7 | Crown height | 2,17–5,16 | 4,10 | 1,26 | – |

Table 11: Measurements of the M³ of *Issiodoromys (Saboyanomys) weidmanni* n. subg. n sp. from Ruisseau du Bey (Switzerland)

| SW | N | | range | \bar{X} | S | V |
|----|---|--------------|-----------|-----------|------|-------|
| 2 | 2 | Length | – | 1,75 | – | – |
| | 2 | Width | 1,33–1,58 | 1,46 | 0,18 | 12,15 |
| 3 | 4 | Sinus height | 3,25–4,42 | 3,73 | 0,52 | 13,95 |
| | 4 | Length | 1,75–2,00 | 1,85 | 0,11 | 5,69 |
| | 6 | Width | 1,42–1,75 | 1,59 | 0,13 | 8,15 |
| | 4 | Crown height | 3,67–4,58 | 4,00 | 0,41 | 10,29 |
| 4 | 8 | Sinus height | 2,67–4,00 | 3,36 | 0,43 | 12,88 |
| | 5 | Length | 1,83–1,92 | 1,87 | 0,05 | 2,64 |
| | 5 | Width | 1,58–1,83 | 1,67 | 0,10 | 5,88 |
| | 6 | Crown height | 3,83–4,17 | 3,88 | 0,29 | 7,59 |
| 5 | 2 | Sinus height | 1,25–2,08 | 1,67 | 0,59 | – |
| | 2 | Length | – | 2,00 | – | – |
| | 2 | Width | 2,00–2,25 | 2,13 | 0,18 | 8,32 |
| | 2 | Crown height | 2,08–2,33 | 2,21 | 0,18 | 8,02 |

- presence of enamel on the lobules of the crown,
- larger size of the P⁴,
- different morphology of P⁴ in unworn stage,
- smaller lobules on the labial border of the upper teeth and lingual border of the lowers,
- lower maxillary height from the labial alveolar border to the dorsal border of the infraorbital canal ridge,
- stronger tendency towards atrophy of the labial roots in P⁴,
- broader lingual root than crown cylinder in the upper molars,
- tendency toward atrophy of the roots in the lower teeth.

Table 12: Measurements of the P₄ of *Issiodoromys (Saboyanomys) weidmanni* n. subg. n sp. from Ruisseau du Bey (Switzerland)

| SW | N | | range | \bar{X} | S | V |
|----|---|----------------|-----------|-----------|------|-------|
| 1 | 1 | Length | – | 1,92 | – | – |
| | 1 | Width | – | 1,08 | – | – |
| 3 | 1 | Sinusid height | – | 3,25 | – | – |
| | 1 | Length | – | 1,75 | – | – |
| | 1 | Width | – | 1,75 | – | – |
| | 1 | Crown height | – | 3,75 | – | – |
| 4 | 2 | Sinusid height | 2,08–2,58 | 2,33 | 0,35 | 15,17 |
| | 2 | Length | 2,08–2,17 | 2,13 | 0,06 | 2,99 |
| | 2 | Width | – | 1,50 | – | – |
| | 2 | Crown height | 2,50–3,00 | 2,75 | 0,35 | 12,86 |
| 5 | 2 | Sinusid height | 0,75–2,08 | 1,41 | 0,94 | – |
| | 1 | Length | – | 2,08 | – | – |
| | 2 | Width | 1,42–1,67 | 1,55 | 0,18 | 11,44 |
| | 2 | Crown height | 1,00–2,67 | 1,84 | – | – |

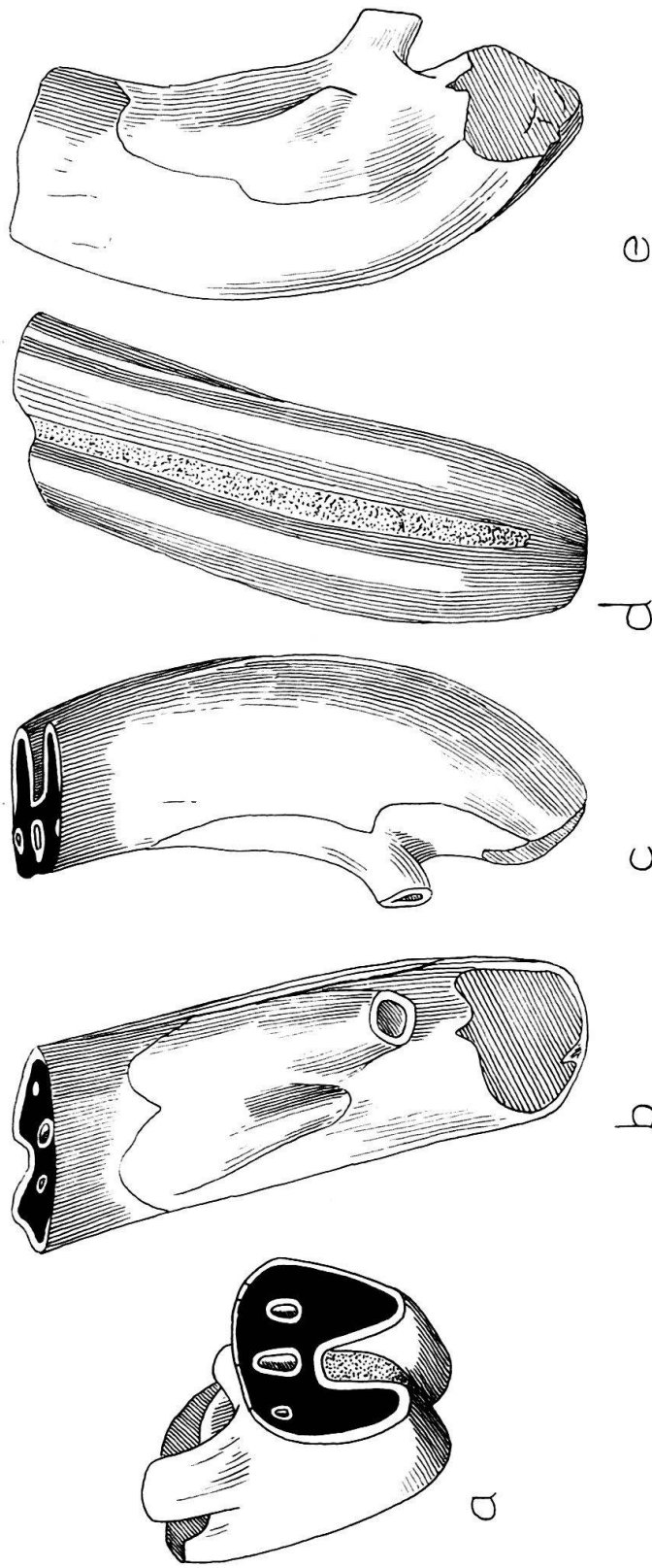

Fig. 15. *Issiodoromys* (*Saboyanomys*) *weidmanni* n. sp. MGL 46368. P⁴ dex (invers.). Holotype. Ruisseau du Bey, Switzerland. a = occlusal view. b = labial view. c = anterior view. d = lingual view. e = posterior view. — All figures × 12,5.

I. (Saboyanomys) weidmanni n. subg. n. sp.

Fig. 15

Derivatio nominis. – After the geologist Dr. Marc Weidmann (Lausanne), principal collector of the material.

Holotype. – MGL 46368. P⁴ dex. in SW-3.

Measurements of the Holotype. – Sinus height: 4,33 · Length: 1,75 · Width: 1,58 · Sinus length: 0,92 · Extrasinus distance: 0,67 · Curvature radius: 4,20 · Crown height: 4,75 · Anterior lobule height: 0,50 · Posterior lobule height: 0,67 · Crown height above anterior lobule: 0,75; above posterior lobule: 0,67.

Paratypes. – SW-1: P⁴. – NMB: RB 1, 2 and 7; M². – NMB: RB 19; M³. – NMB: RB 36. P₄. – MGL 46331; M_{1/2}. – NMB: RB 23. SW-2: M¹. – MGL 46309; M². – NMB: RB 17; M³. – NMB: RB 37; MGL 46303; P₄. – NMB: RB 42 f; M₃. – NMB: RB 43; MGL 46350. SW-3: P⁴. – MGL 46365 and 46370; NMB: RB 3 and 8; M¹. – MGL 46308 and 46314; M². – MGL 46364. M³. – NMB: 39 f and 40; MGL 46321, 46325, 46327 and 46332. P₄. – NMB: RB 42 f; M_{1/2}. – MGL 46323, 46326, 46344 and 46366; NMB: RB 27; M₃. – MGL 46351. SW-4: P⁴. – MGL 46307, 46313, 46317 and 46367; NMB: RB 4–6; M¹. – MGL 46304–06, 46310–11; NMB: 10 and 15; M². – MGL 46287 and NMB: RB 18; M³. – NMB: RB 33, 34, 35, 40 and 41 f; MGL: 46335, 46339 f and 46348; P₄. – MGL 46336 and NMB: RB 39. M_{1/2}. – MGL 46312, 46322, 46328, 46330, 46338, 46346 and 46374. NMB: RB 25, 26, 28, 30 and 32; M₃. – MGL: 46352, 46357 and 46362; NMB: RB 44. SW-5: P⁴. – MGL 46289, 46316 and 46361; NMB: RB 9; M¹. – NMB: RB 11–14 and 16. M². – MGL 46263; NMB: 20–22; M³. – NMB: RB 38 and 41. P₄. – 46328, 4633 (e) and 46369. M_{1/2}. – NMB: 24, 26 and 29; MGL: 46329, 46341, 46342, 46345, 46347, 46354, 46356, 46379 and 46383.

Type locality. – Ruisseau du Bey, North of Method, Switzerland (see JORDI 1955, p. 34). However, the list of the fauna offered by JORDI does not belong to Ruisseau du Bey.

Other locality. – Fornant-7.

Table 13: Measurements of the M_{1/2} of *Issiodoromys (Saboyanomys) weidmanni* n. subg. n. sp. from Ruisseau du Bey (Switzerland)

| SW | N | | range | \bar{X} | S | V |
|----|----|----------------|-----------|-----------|------|-------|
| 1 | 1 | Length | – | 1,75 | – | – |
| | 1 | Width | – | 1,25 | – | – |
| 3 | 4 | Sinusid height | 4,92–5,67 | 5,19 | 0,34 | 6,48 |
| | 5 | Length | 2,25–2,58 | 2,43 | 0,15 | 6,08 |
| | 3 | Width | 1,67–1,83 | 1,77 | 0,09 | 5,20 |
| | 2 | Crown height | 5,00–5,25 | 5,12 | 0,18 | 3,45 |
| 4 | 12 | Sinusid height | 3,67–5,00 | 4,53 | 0,45 | 10,01 |
| | 11 | Length | 2,17–2,58 | 2,39 | 0,13 | 5,38 |
| | 8 | Width | 1,67–2,00 | 1,76 | 0,11 | 6,33 |
| | 12 | Crown height | 4,33–5,50 | 4,89 | 0,39 | 7,96 |
| 5 | 12 | Sinusid height | 1,92–4,83 | 3,55 | 1,01 | – |
| | 11 | Length | 2,17–2,58 | 2,33 | 0,14 | 6,03 |
| | 9 | Width | 1,50–2,17 | 1,88 | 0,19 | 9,99 |
| | 12 | Crown height | 3,00–5,17 | 3,94 | 0,97 | – |

Table 14: Measurements of the M_3 of *Issiodoromys* (*Saboyanomys*) *weidmanni* n. subg. n. sp. from Ruisseau du Bey (Switzerland)

| SW | N | | range | \bar{X} | S | V |
|----|---|----------------|-----------|-----------|------|-------|
| 2 | 2 | Length | 2,00–2,08 | 2,04 | 0,06 | 2,77 |
| | 2 | Width | 1,33–1,58 | 1,46 | 0,18 | 12,15 |
| 3 | 1 | Sinusid height | – | 4,33 | – | – |
| | 1 | Length | – | 2,33 | – | – |
| | 1 | Width | – | 1,75 | – | – |
| | 1 | Crown height | – | 4,67 | – | – |
| 4 | 4 | Sinusid height | 3,75–4,25 | 3,98 | 0,23 | 5,77 |
| | 2 | Length | 1,75–2,17 | 1,96 | 0,30 | 15,15 |
| | 3 | Width | 1,67–3,42 | 2,25 | – | – |
| | 4 | Crown height | 3,92–4,50 | 4,27 | 0,25 | 5,78 |

Type formation. – Untere bunte Mergel (Lower Motley Marls).

Stratum type. – Layer 2 of the JORDI profile (1955, p. 34, Fig. 10).

Stratigraphic range. – Oligocene, Upper “Chattien”, assemblage zone of Fornant-7 (see ENGESER & MAYO 1987).

Geographical distribution. – The same as of the Subgenus.

Diagnosis. – Species of small size and with low hypsodonty. Mean of curvature radii: $P^4 = 4,20$; $M^{1/2} = 3,86$; Boundary of sinus height in SW-4: $M^1 = 6,08–5,16$; $M^2 = 6,00–5,25$. Height of anterior lobule: $M^1 = 0,36–0,40$; $M^2 = 0,58–0,83$; $M_{1/2} = 2,08$. P^4 with a scarcely semiatrophied anterior labial root. Labial roots of $M^{1/2}$ atrophied, lingual roots large and not atrophied. Lower roots large and slightly semiatrophied.

Discussion. – In the stratum 7 from the Fornant profile (see WEIDMANN 1982, p. 18–21, Fig. 5 and 6 in: JUNG) some material of this species was found. It is somewhat less evolved with a slightly lower crown height but of equal size. This is an indication of the gradual chronoclinal evolution, and it cannot be separated into different species or even as a subspecies. The comparison (by the Student t-test) of the sample of Ruisseau du Bey with the sample of Fornant-7 for the lengths of P^4 in SW-3, 4 and 5 (19 specimens) showed not significant differences.

Measurements in the Tables 9–14.

Statistical test in the Tables 54–56.

Table 15: Measurements of the P^4 of *Issiodoromys* (*Saboyanomys*) *oppligeri* n. subg. n. sp. from Fornant-6 (France)

| SW | N | | range | \bar{X} | S | V |
|----|---|--------------|-----------|-----------|------|-------|
| 3 | 2 | Sinus height | 4,50–4,58 | 4,54 | 0,06 | 1,25 |
| | 2 | Length | 1,83–2,17 | 2,00 | 0,24 | 12,02 |
| | 2 | Width | 1,50–1,92 | 1,71 | 0,30 | 17,38 |
| | 2 | Crown height | 4,83–4,92 | 4,88 | 0,06 | 1,31 |
| 4 | 4 | Sinus height | 3,67–4,00 | 3,82 | 0,17 | 4,47 |
| | 4 | Length | 2,00–2,08 | 2,02 | 0,04 | 1,98 |
| | 4 | Width | 1,67–1,92 | 1,79 | 0,11 | 5,98 |
| | 2 | Crown height | 4,08–4,25 | 4,17 | 0,12 | 2,89 |
| 5 | 5 | Sinus height | 2,67–3,75 | 3,22 | 0,44 | 13,74 |
| | 3 | Length | 1,83–2,00 | 1,92 | 0,09 | 4,44 |
| | 5 | Width | 1,67–1,83 | 1,73 | 0,09 | 5,05 |
| | 4 | Crown height | 3,08–4,50 | 3,69 | 0,72 | – |

Table 16: Measurements of the $M^{1/2}$ of *Issiodoromys (Saboyanomys) oppligeri* n. sp. from Fornant-6 (France)

| SW | N | | range | \bar{X} | S | V |
|----|---|--------------|-----------|-----------|------|-------|
| 1 | 1 | Length | – | 1,75 | – | – |
| | 1 | Width | – | 1,17 | – | – |
| 2 | 1 | Length | – | 1,83 | – | – |
| | 1 | Width | – | 1,42 | – | – |
| 3 | 2 | Length | – | 2,08 | – | – |
| | 2 | Width | 1,67–1,83 | 1,75 | 0,11 | 6,46 |
| 4 | 3 | Sinus height | 5,41–6,00 | – | – | – |
| | 3 | Length | 1,83–2,08 | 1,97 | 0,13 | 6,48 |
| | 3 | Width | 1,75–1,83 | 1,80 | 0,05 | 2,56 |
| 5 | 8 | Sinus height | 1,25–4,58 | 3,21 | 1,15 | – |
| | 8 | Length | 1,92–2,33 | 2,08 | 0,13 | 6,37 |
| | 7 | Width | 1,75–2,33 | 2,26 | 0,24 | 10,73 |
| | 7 | Crown height | 2,17–5,00 | 3,88 | 0,95 | – |

Table 17: Measurements of the M^3 of *Issiodoromys (Saboyanomys) oppligeri* n. sp. from Fornant-6 (France)

| SW | N | | range | \bar{X} | S | V |
|----|---|--------------|-----------|-----------|------|-------|
| 1 | 1 | Length | – | 1,75 | – | – |
| | 1 | Width | – | 1,33 | – | – |
| 2 | 1 | Sinus height | – | 4,58 | – | – |
| | 4 | Length | 1,67–1,84 | 1,75 | 0,07 | 3,96 |
| | 4 | Width | 1,67–2,08 | 1,77 | 0,21 | 11,57 |
| | 1 | Crown height | – | 4,67 | – | – |
| 3 | 2 | Sinus height | 3,58–4,42 | 4,00 | 0,59 | 14,85 |
| | 2 | Length | 1,83–2,83 | 2,33 | 0,71 | – |
| | 2 | Crown height | 4,42–4,75 | 4,59 | 0,23 | 5,09 |
| 4 | 2 | Sinus height | 2,33–3,25 | 2,79 | 0,65 | – |
| | 2 | Length | 2,20–2,25 | 2,23 | 0,04 | 1,59 |
| | 2 | Width | 2,08–2,50 | 2,29 | 0,30 | 12,97 |
| | 1 | Crown height | – | 3,25 | – | – |
| 5 | 5 | Sinus height | 1,75–3,33 | 2,57 | 0,74 | – |
| | 3 | Length | 2,00–2,08 | 2,03 | 0,05 | 2,28 |
| | 3 | Width | 2,00–2,17 | 2,08 | 0,09 | 4,08 |
| | 4 | Crown height | 2,50–4,08 | 3,29 | 0,71 | – |

I. (Saboyanomys) oppligeri n. sp.

Fig. 16

Synonymy. –1984 *Issiodoromys* n. sp. MAYO, p. 15 and 23 in: ENGESSER et al.*Derivatio nominis.* – After Mr. Daniel Oppliger (Basel), fossil vertebrate preparator at NMB and one of the collectors of this material.

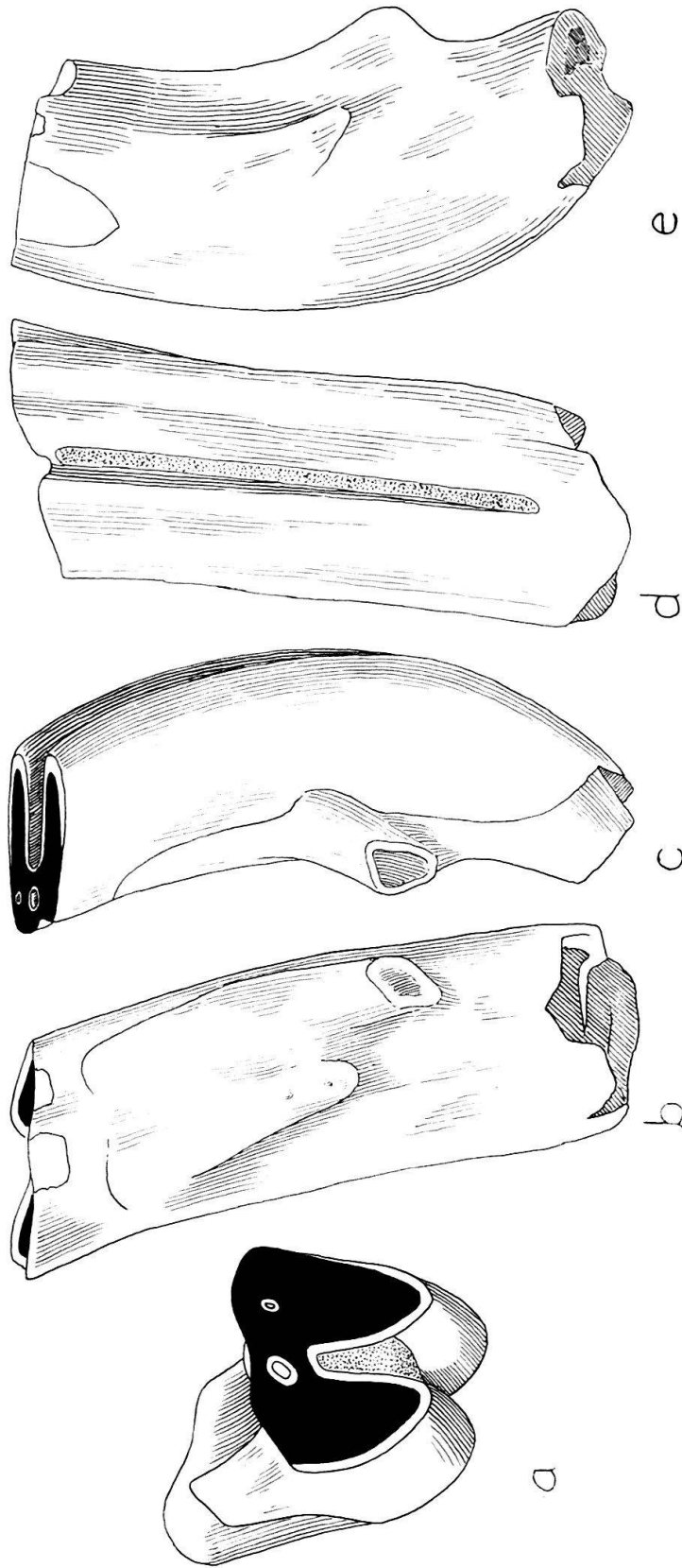

Fig. 16. *Issidoromys* (*Saboyanomys*) *oppligeri* n. sp. NMB: Sav 202. P⁴ dex (invers.). Fornant-6, Savoy, France. a = lingual view. b = labial view. c = anterior view. d = occlusal view. e = posterior view. All figures × 12,5.

Table 18: Measurements of the P₄ of *Issiodoromys (Saboyanomys) oppligeri* n. sp. from Fornant-6 (France)

| SW | N | | range | \bar{X} | S | V |
|----|---|----------------|-----------|-----------|------|-------|
| 4 | 4 | Sinusid height | 2,33–4,33 | 3,33 | 0,82 | – |
| | 2 | Length | 2,00–2,17 | 2,06 | 0,10 | 4,77 |
| | 2 | Width | 1,33–1,58 | 1,46 | 0,18 | 12,15 |
| | 2 | Crown height | 2,67–3,50 | 3,09 | 0,59 | 19,02 |
| 5 | 4 | Sinusid height | 1,25–1,75 | 1,46 | 0,21 | 14,33 |
| | 1 | Length | – | 2,33 | – | – |
| | 4 | Width | 1,42–1,67 | 1,57 | 0,13 | 8,02 |
| | 4 | Crown height | 1,83–2,25 | 2,00 | 0,21 | 10,29 |

Holotype. – NMB: Sav 202, P⁴ dex. in SW-3 terminal.

Measurements of the Holotype. – Sinus height: 4,50 · Length: 21,7 · Width: 1,92 · Sinus length: 1,25 · Extrasinus distance: 0,67 · Curvature radius: 3,60 · Crown height: 4,83 · Height of the lobules not observable.

Paratypes. SW-1. – M¹: NMB: Sav 203; M³: NMB: Sav 204; SW-2. – M²: NMB: Sav 205; M³: NMB: Sav 206–209. SW-3. – P⁴: NMB: Sav 210–211; M¹: NMB: Sav 210–213; M³: NMB: Sav 214–215; P₄: NMB: Sav 216; M₃: NMB: Sav 217. SW-4. – NMB: Sav 218–221; M²: NMB: Sav 222–224; M³: NMB: Sav 225–227; P₄: NMB: Sav 228–230; M_{1/2}: NMB: Sav 231–235; M₃: NMB: Sav 236. SW-5. – P⁴: NMB: Sav 237–241; M¹: NMB: Sav 242–248; M²: NMB: Sav 249; M³: NMB: Sav 250–254; P₄: NMB: Sav 255–258; M_{1/2}: NMB: Sav 259–273; M₃: NMB: Sav 274–276.

Type locality. – Le Fornant, High Savoy, near to Frangy (France).

Type formation. – Molasse rouge (Red Molasse).

Stratum type. – Layer 6 of the profile of Le Fornant river. See WEIDMANN (1982, pl. 18–21, Fig. 5 and 6, in: JUNG).

Stratigraphic range. – Upper Oligocene, assemblage zone of Fornant-6 (see ENGESSER & MAYO 1987).

Geographical distribution. – The same as of the Subgenus.

Diagnosis. – Species of larger size and more hypsodontic than *I. (Saboyanomys) weidmanni*. Mean of curvature radii: P⁴ = 3,9; M^{1/2} = 4,13. Boundary of sinus height viewed in SW-4: M² = 6,00–5,45; M_{1/2} = 5,33–4,92; in SW-5: M¹ = 4,58 and M_{1/2} = 5,00. Height of anterior lobule: M^{1/2} = 0,92; M_{1/2} = 2,42. Upper teeth with more atrophied roots and lowers with more semiatrophied roots than in *S. (Saboyanomys) weidmanni*. Lower teeth with slipping crest.

Table 19: Measurements of the M_{1/2} of *Issiodoromys (Saboyanomys) oppligeri* n. sp. from Fornant-6 (France)

| SW | N | | range | \bar{X} | S | V |
|----|----|----------------|-----------|-----------|------|-------|
| 4 | 6 | Sinusid height | 4,92–5,33 | 5,09 | 0,17 | 3,25 |
| | 6 | Length | 2,33–2,50 | 2,43 | 0,12 | 5,03 |
| | 6 | Width | 1,58–2,00 | 1,79 | 0,17 | 9,75 |
| | 2 | Crown height | 5,00–5,50 | 5,25 | 0,35 | 6,73 |
| 5 | 15 | Sinusid height | 1,33–5,00 | 3,51 | 1,13 | – |
| | 14 | Length | 2,08–2,75 | 2,47 | 0,20 | 7,97 |
| | 12 | Width | 1,67–2,17 | 1,85 | 0,21 | 11,20 |
| | 14 | Crown height | 1,83–5,50 | 4,02 | 1,01 | – |

Table 20: Measurements of the M_3 of *Issiodoromys (Saboyanomys) oppligeri* n. sp. from Fornant-6 (France)

| SW | N | | range | \bar{X} | S | V |
|----|---|----------------|-----------|-----------|------|-------|
| 3 | 1 | Sinusid height | – | 4,67 | – | – |
| | 1 | Length | – | 2,25 | – | – |
| | 1 | Width | – | 1,42 | – | – |
| | 1 | Crown height | – | 4,92 | – | – |
| 4 | 2 | Sinusid height | 3,67–4,33 | 4,00 | 0,47 | 11,67 |
| | 2 | Length | 2,17–2,42 | 2,31 | 0,18 | 7,70 |
| | 2 | Width | 1,75–2,00 | 1,88 | 0,18 | 9,43 |
| | 2 | Crown height | 4,08–4,75 | 4,42 | 0,47 | 10,73 |
| 5 | 3 | Sinusid height | 1,83–3,75 | 2,67 | 0,98 | – |
| | 3 | Length | 2,25–2,42 | 2,30 | 0,10 | 4,26 |
| | 1 | Width | – | 1,58 | – | – |
| | 3 | Crown height | 2,67–4,00 | 3,25 | 0,68 | – |

Differential diagnosis. – *I. (Saboyanomys) oppligeri* n. sp. differs from *I. (Saboyanomys) weidmanni* n. subg. n. sp. in the following characters:

- longer P^4 and $M^{1/2}$,
- higher hypsodonty,
- different mean of the curvature radii,
- different height of the lobules,
- more atrophied roots in upper teeth and more semiatrophied in lowers,
- slipping crest in lingual roots of the lower teeth.

Discussion. – The Student t-test showed the highly significant difference between the samples of *I. (Saboyanomys) oppligeri* n. sp. from Fornant-6 and *I. (Saboyanomys) weidmanni* n. subg. n. sp. in the length of all the P^4 in SW-3 and 4 (15 specimens), and of the $M^{1/2}$ in SW-3, 4 and 5 (35 specimens). Also, the sinus height of the $M^{1/2}$ in SW-3 and 4 (18 specimens) showed a significant difference of 5%. Nevertheless, the length of the $M^{1/2}$ did not show a significant difference. That can be accounted by the greater length of the P_4 and by the special morphological function of the crown construction of $M^{1/2}$ relating to the M_3 .

Measurements in the Tables 15–20.

Statistical test in the Tables 54 and 56.

I. (Saboyanomys) rickenbachensis n. sp.

Fig. 17

Derivatio nominis. – After Rickenbach, type locality of the species.

Holotype. – NMB: UM 625 (P^4 dex.) in SW-4.

Table 21: Measurements of the P^4 of *Issiodoromys (Saboyanomys) rickenbachensis* n. sp. from Rickenbach (Switzerland)

| SW | Sinus height | Length | Width | Crown height |
|----|--------------|--------|-------|--------------|
| 1 | – | 1,50 | 1,25 | – |
| 2 | – | 1,58 | 1,25 | – |
| 4 | 4,83 | 1,83 | 1,75 | 4,92 |

Table 22: Measurements of the $M^{1/2}$ of *Issiodoromys (Saboyanomys) rickenbachensis* n.sp. from Rickenbach (Switzerland)

| SW | N | | range | \bar{X} | S | V |
|----|----|--------------|-----------|-----------|------|-------|
| 2 | 3 | Length | 1,83–2,00 | 1,92 | 0,09 | 4,44 |
| | 3 | Width | 1,42–1,58 | 1,47 | 0,09 | 6,27 |
| 3 | 2 | Length | 2,00–2,17 | 2,09 | 0,12 | 5,76 |
| | 2 | Width | 1,58–1,67 | 1,63 | 0,06 | 3,92 |
| 4 | 2 | Length | 2,00–2,08 | 2,04 | 0,06 | 2,77 |
| | 3 | Width | 1,67–1,75 | 1,70 | 0,04 | 2,56 |
| 5 | – | Sinus height | – | > 6,33 | – | – |
| | 10 | Length | 1,83–2,17 | 1,80 | 0,17 | 8,24 |
| | 11 | Width | 1,42–2,25 | 1,80 | 0,25 | 14,10 |

Measurements of the Holotype. – Sinus height: 4,83 · Length: 1,83 · Width: 1,75. Sinus Length: 1,25. Extrasinus distance: 0,33 · Crown height: 4,92 · Curvature radius: 4,80.

Paratypes. – SW-1: P^4 . – NMB: UM 2831. SW-2: P^4 : NMB: Rick 1. $M^{1/2}$. – NMB: UM 355, HR 259. M^3 . – NMB: UM 1282; Rick 3. P_4 . – NMB: UM 1974. SW-3: $M^{1/2}$ NMB: HR 181; UM 1083. M^3 . – NMB: UM 1310a; $M_{1/2}$. – NMB: HR 1003; Rick 25. SW-4. – $M^{1/2}$. – NMB: UM 1080, 1299; Rick 4. M^3 . – NMB: UM 560, 7119, 1904 and 140. P_4 . – NMB: UM 1094, 1909 and 354; HR 265. $M_{1/2}$. – NMB: UM 628; Rick 26. M_3 . – NMB: HR 1001; Rick 34. SW-5: P^4 . – Rick 24; $M^{1/2}$. – NMB: UM 620, 626, 3200, 621, 2125, 2658, 625 and 2661; Rick 19–11, 2 and 22. M^3 . – NMB: Rick 32, 33. P_4 . – NMB: UM 1935 and 2659. $M_{1/2}$. – NMB: UM 2112, 6160, 1301, 1309, 1302, 1034, 654, 1091, 6159, 676; Rick 27–30. M_3 . – NMB: UM 656 and 1914. Maxillary fragment: NMB: UM 1282 (P^4 – M^3 : P^4 in SW-3, M^1 – M^2 in SW-4 and M^3 in SW-2).

Hypodigm. – In addition to Holotypes and Paratypes the following specimens: P^4 : NMB: UM 2381 in SW-1 and UM 109f in SW-4. $M_{1/2}$: NMB: HR 907.

Type formation. – Molasse alsacienne.

Stratum type. – Knauriger Sandstein (Concretionary Sandstone). See KEHRER (1922, p. 22) and profile in KFSNMB.

Stratigraphic range. – Oligocene, Upper “Chattien”, assemblage zone of Rickenbach (see ENGESSER & MAYO 1987).

Table 23: Measurements of the M^3 of *Issiodoromys (Saboyanomys) rickenbachensis* n.sp. from Rickenbach (Switzerland)

| SW | N | | range | \bar{X} | S | V |
|----|---|--------------|-----------|-----------|------|------|
| 3 | 1 | Length | – | 2,00 | – | – |
| | 1 | Width | – | 1,58 | – | – |
| 4 | 2 | Sinus height | 4,67–4,92 | 4,80 | 0,18 | 3,69 |
| | 3 | Length | 1,83–2,00 | 1,94 | 0,10 | 5,05 |
| | 3 | Width | 1,58–1,83 | 1,72 | 0,13 | 7,42 |
| | 2 | Crown height | – | 5,00 | – | – |
| 5 | 1 | Sinus height | – | 4,75 | – | – |
| | 1 | Length | – | 2,00 | – | – |
| | 1 | Width | – | 1,83 | – | – |
| | 1 | Crown height | – | 5,00 | – | – |

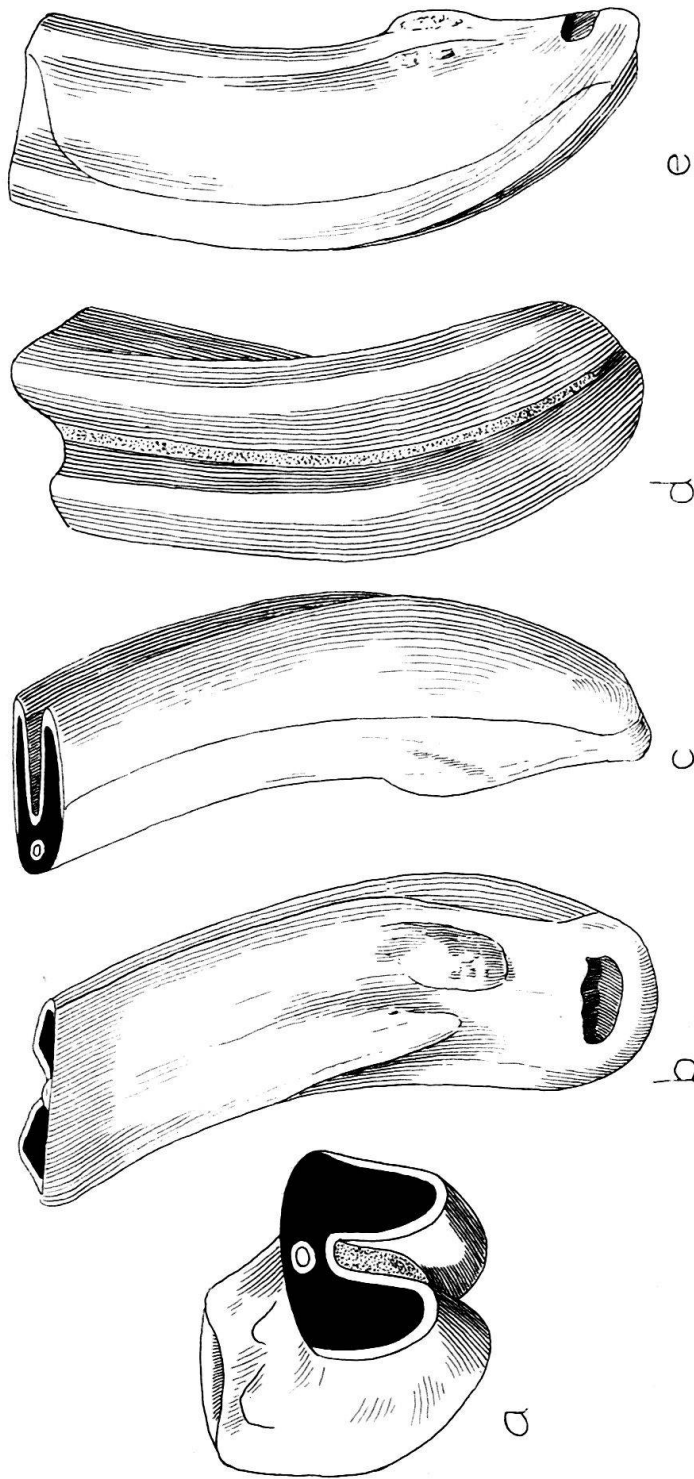

Fig. 17. *Issidoromys* (*Saboyanomys*) *rickenbachensis* n. sp. NMB: UM 625. P⁴ dex (invers). Holotype. Rickenbach, Switzerland. a = occlusal view. b = labial view. c = anterior view. d = lingual view. e = posterior view. — All figures × 12,5.

Table 24: Measurements of the P₄ of *Issidoromys (Saboyanomys) rickenbachensis* n.sp. from Rickenbach (Switzerland)

| SW | N | | range | \bar{X} | S | V |
|----|---|----------------|-----------|-----------|------|-------|
| 4 | 3 | Sinusid height | 4,17–5,50 | 4,75 | 0,68 | 14,34 |
| | 4 | Length | 1,75–2,25 | 2,02 | 0,23 | 11,36 |
| | 4 | Width | 1,33–1,58 | 1,46 | 0,14 | 9,92 |
| | 2 | Crown height | 4,42–4,92 | 4,67 | 0,35 | 7,57 |
| 5 | 2 | Sinusid height | 1,50–3,17 | 2,34 | – | – |
| | 1 | Length | – | 2,00 | – | – |
| | 1 | Width | – | 1,42 | – | – |
| | 2 | Crown height | 2,08–3,50 | 2,79 | – | – |

Geographical distribution. – Central Europe.

Diagnosis. – Species of the same size, but more hypsodont than *I. (S.) oppligeri*. Mean of curvature radii: $M^{1/2} = 4,00$. Boundary of the sinus height viewed in SW-5: 6,17. Height of anterior lobule in $M^{1/2} = 0,58–0,67$. Height of posterior lobule: $M^{1/2} = 0,42–0,58$. $M^{1/2} = 1,25–3,58$. Enamel borders of the crown thick. P⁴ with two vestigial labial roots. $M^{1/2}$ with fully atrophied labial roots. Lower teeth with fully atrophied lingual roots and vestigial labial root.

Differential diagnoses. – *I. (Saboyanomys) rickenbachensis* n. sp. differs from *I. (Saboyanomys) weidmanni* n. subg. n. sp. in the following characters:

- larger size,
- very high hypsodonty,
- different mean of curvature radii,
- different boundaries of sinus and sinusid height,
- different thickness of the enamel borders,
- different height of the anterior and posterior lobules,
- vestigial labial roots in P⁴
- fully atrophied labial roots in $M^{1/2}$,
- vestigial and fully atrophied roots in lower teeth.

From *I. (Saboyanomys) oppligeri* n. sp. in the:

- higher hypsodonty,

Table 25: Measurements of the M_{1/2} of *Issidoromys (Saboyanomys) rickenbachensis* n.sp. from Rickenbach (Switzerland)

| SW | N | | range | \bar{X} | S | V |
|----|----|----------------|-----------|-----------|------|------|
| 3 | 2 | Length | 2,17–2,42 | 2,30 | 0,17 | 7,70 |
| | 2 | Width | 1,33–1,50 | 1,42 | 0,12 | 8,50 |
| 4 | 2 | Length | 2,17–2,33 | 2,25 | 0,11 | 5,03 |
| | 2 | Width | 1,58–1,67 | 1,63 | 0,06 | 3,92 |
| 5 | 9 | Sinusid height | 2,92–6,50 | 4,27 | 1,14 | – |
| | 11 | Length | 2,25–2,75 | 2,43 | 0,13 | 5,22 |
| | 12 | Width | 1,50–2,08 | 1,79 | 0,17 | 9,56 |
| | 9 | Crown height | 3,33–6,67 | 4,78 | 1,09 | – |

In addition:

- the same seven characters as by *I. (Saboyanomys) weidmanni* n. subg. n. sp., starting from character number three (“different mean of curvature radii”).

Measurements in the Tables 21–26.

Statistical test in the Tables 54–56.

Table 26: Measurements of the M_3 of *Issiodoromys (Saboyanomys) rickenbachensis* n.sp. from Rickenbach (Switzerland)

| SW | N | | range | \bar{X} | S | V |
|----|---|----------------|-----------|-----------|------|------|
| 4 | 1 | Sinusid height | – | 5,17 | – | – |
| | 2 | Length | 1,12–1,20 | 1,16 | 0,06 | 4,88 |
| | 2 | Width | 1,83–2,00 | 1,92 | 0,12 | 6,28 |
| | 1 | Crown height | – | 5,33 | – | – |
| 5 | 1 | Sinusid height | – | 4,08 | – | – |
| | 2 | Length | – | 1,16 | – | – |
| | 2 | Width | 1,83–2,08 | 1,96 | 0,18 | 9,04 |

Genus *Nesokerodon* SCHLOSSER 1884

Type species. – *Nesokerodon quercy* SCHLOSSER 1884.

Stratigraphic range. – Lower to Middle Oligocene, from Balm to Aarwangen assemblage zones in the faunal province of Switzerland and Savoy (see ENGESSER & MAYO 1987).

Geographical distribution. – Central and West Europe.

Previous diagnoses. – SCHLOSSER 1884, p. 16–20; LYDEKKER 1885, p. 253; ZITTEL 1891–93, p. 525; VIRET 1929, p. 85.

Emended diagnosis. – Semihypsodont Issiodoromyinae. Maxilla very expanded labially in front of P^4 ; external border against M^2 – M^3 lies perpendicular to the abrasive surface of the crown; labial and lingual alveolar borders very slightly separated; external alveolar border softly curved; infraorbital canal wide to very wide. Ascending ramus of anterior zygomatic process with very concave anterior border. Ventral surface of the masseteric apophysis of the anterior zygomatic process with a relatively wide masseteric fossa. Vertical foramen inside fossa. Posterior border of incisive foramen in front of the contact between P^4 and M^1 . Palatine vault with a groove. Posterior palatine foramen in front of M^2 . Teeth with low to high semihypsodonty. Upper teeth: with subrounded crown on unworn surface; semihypsodonty of slight to moderate sagittal rotation; wear widespread to complete occlusal surface of crown; antyclines and some synclines soon disappear with abrasion; labial border of the crown vertical, or slightly inclined with respect to the labial roots; enamel height in labial border small; lobules very short. P^4 – M^3 with normal labial roots. M^1 and M^2 with labial roots emerging from the labial border of the crown. Lingual root: bent slightly along its length; labial-lingually convex and wide in the posterior half; concavity of its labial border shallow and narrow, without a horizontal space between the labial and lingual roots below the crown. Mandible: with inclined short

shelflike masseteric ridge relatively near to the alveolar border. Lower and upper masseteric ridges; or without lower, but with short and slightly prominent longitudinal masseteric ridge. Without longitudinal masseteric sulcus. Lower teeth with or without antecuspid; with II, III and IV synclinids; with pseudograben (rarely without) and two roots. P_4 of equal or larger size than the lower molars.

Differential diagnoses. – *Nesokerodon* differs from other Issidoromyinae genus in the following characters:

From *Issidoromys* CROIZET in the:

- different infraorbital canal,
- vertical external ridge of infraorbital canal,
- presence of a masseteric fossa on ventral surface of masseteric apophysis of the anterior zygomatic process,
- presence of a vertical foramen inside masseteric fossa,
- presence of semihypsodonty,
- presence of normal labial roots in the upper teeth,
- presence of very small lobules,
- small crown height on the labial border of the upper teeth and on the lingual border of the lowers,
- presence of a barrel form in the crown of the upper teeth,
- presence of a narrow and shallow pseudograben in the upper teeth,
- wider and deeper synclines and synclinids,
- transversal ridge in a more median position on the crown surface of the upper and lower teeth,
- presence of shelflike masseteric ridge in the mandible,
- presence of an angular upper masseteric ridge on the mandible,
- presence of an angular lower masseteric ridge on the mandible,
- absence of a longitudinal sulcus on the mandible.

From *Pseudoltinomys* LAVOCAT 1952, in the:

- greater maxillary height dorsally to M^2 – M^3 ,
- different infraorbital canal (proportionally deeper and more closed in comparison),
- presence of a groove in the palatine vault,
- comparatively shorter palatine vault,
- different position of the incisive foramen,
- reduced synclines.

From *Elfomys* HARTENBERGER 1971 in the:

- comparatively shorter palatine vault,
- much longer incisive foramen,
- higher semihypsodonty,
- absence of brachyodont teeth,
- reduction or absence of the bunodont traces in the teeth,
- much better formed antyclines and antyclinids,
- more developed and deeper synclines and synclinids,
- tendency to increase in size,
- more developed and deeper pseudograben,

- absence of teeth without pseudograben in the upper teeth,
- absence of wrinkled enamel in the teeth.

Discussion. – PALMER (1904, p.458) designated as type species of *Nesokerodon* (SCHLOSSER 1884 to “*Issiodoromys*” *minor* FILHOL 1877. This species cannot be accepted as the type species of the genus according to the Article 167g of the Int. Code of Zoological Nomenclature (see SCHLOSSER 1884, p.15). The reintroduction of the genus *Nesokerodon* SCHLOSSER 1884 is recommended because of the discovery of *Issiodoromys* CROIZET as an invader of the Molasse basin of Switzerland and Savoy, and also it is polyphyletic (see ENGESSER et al. 1986; ENGESSER & MAYO 1987; MAYO 1987 and more details in MAYO 1987a).

Table 27: Measurements of the D⁴ and P⁴ of *Nesokerodon balmensis* n. sp. from Balm (Switzerland)

| Tooth | SW | N | | range | \bar{X} | S | V |
|----------------|----|---|---------------------|-----------|-----------|------|------|
| D ⁴ | | 3 | Sinus height | 0,17–0,50 | 0,30 | 0,12 | – |
| | | 3 | Length | 1,50–1,60 | 1,53 | 0,04 | 3,77 |
| | | 3 | Width | 1,17–1,25 | 1,20 | 0,03 | 3,86 |
| | | 3 | Crown height | 0,58–0,92 | 0,77 | 0,12 | – |
| P ⁴ | 1 | 2 | Sinus height | – | 1,33 | – | – |
| | | 2 | Length | 1,33–1,42 | 1,38 | 0,06 | 4,63 |
| | | 2 | Width | – | 1,17 | – | – |
| | | 2 | Crown height | 1,75–1,83 | 1,79 | 0,06 | 3,16 |
| | 4 | 1 | Sinus height | – | 0,58 | – | – |
| | | 1 | Length | – | 1,50 | – | – |
| | | 1 | Width | – | 1,50 | – | – |
| | | 1 | Sinus length | – | 0,50 | – | – |
| | | 1 | Extrasinus distance | – | 1,00 | – | – |
| | | 1 | Crown height | – | 1,08 | – | – |

Nesokerodon balmensis n. sp.

Fig. 18

Synonymy. –

- 1941 *Oltinomy* sp. STEHLIN, p.213 and 219 in: ERNI.
 1966 *Pseudoltinomy* sp. II. THALER, p.91.
 1976 *Elfomys* sp. VIANEY-LIAUD, p. 21 and 24, in part.
 1976 *Elfomys medius* VIANEY-LIAUD, p. 25 and 32, Table 6; 89 and 93, Fig. 45 and 46, in part.
 1979 *non Elfomys medius* VIANEY-LIAUD, p. 227.

Derivatio nominis. – After Balm, type locality of this species.

Holotype. – NMB: Blm 210. P⁴ sin. in SW-1.

Measurements of the Holotype. – Sinus height: 1,40. Length: 1,04. Width: 1,00. Crown height: 1,80. Width between the paracone and protocone: 0,90.

Paratypes. – D⁴. – NMB: Blm 205; NMO: Blm 81 and 82; D₄. – NMB: Blm 242; NMO: Blm 73. SW-1: P⁴. – NMB: Blm 93. M¹. – NMB: Blm 30 and 208. NMO: Blm 76, 79 and 89. M². – NMB: Blm 88 and 91. M³. – Blm 25, 50 and 80. NMO: Blm 72, 85 and 86. P₄. – NMB: Blm 192. M_{1/2}. – NMB: Blm 23, 187, 193, 198 and 200. NMO: Blm 98 and 125f. M₃. – NMB: Blm 190. SW-2: M¹. – NMB: Blm 32f, 201, 204 and 209. NMO: Blm 77f and 130. M². – NMB: Blm 27, 29, 33e, 78, 90 and 128. NMO: Blm 74f, 72f. M³. –

Table 28: Measurements of the M¹ of *Nesokerodon balmensis* n. sp. from Balm (Switzerland)

| SW | N | | range | \bar{X} | S | V |
|----|---|---------------------|-----------|-----------|------|------|
| 1 | 5 | Sinus height | 1,25–1,50 | 1,37 | 0,10 | 7,03 |
| | 5 | Length | 1,33–1,50 | 1,42 | 0,09 | 6,00 |
| | 5 | Width | 1,00–1,17 | 1,08 | 0,09 | 7,84 |
| | 5 | Crown height | 1,75–2,00 | 1,83 | 0,12 | 6,46 |
| 2 | 5 | Sinus height | 1,17–1,33 | 1,22 | 0,07 | 5,87 |
| | 5 | Length | 1,42–1,58 | 1,50 | 0,06 | 3,77 |
| | 5 | Width | 1,17–1,25 | 1,22 | 0,04 | 3,60 |
| | 4 | Crown height | 1,67–1,83 | 1,75 | 0,07 | 3,73 |
| 4 | 1 | Sinus height | – | 0,75 | – | – |
| | 1 | Length | – | 1,33 | – | – |
| | 1 | Width | – | 1,58 | – | – |
| | 1 | Sinus length | – | 0,58 | – | – |
| | 1 | Extrasinus distance | – | 1,08 | – | – |
| | 1 | Crown height | – | 1,17 | – | – |

NMB: Blm 25, 71, 75 f and 87. P₄. – NMB: Blm 107. M_{1/2}. – NMB: Blm 124, 196 and 199. NMO: Blm 101, 104, 105, 116, 117 and 123. M₃. – NMB: Blm 189. NMO: Blm 110. SW-3: M¹. – NMO: Blm 127 (e). M². – NMB: Blm 21. M³. – NMB: Blm 202. NMO: Blm 84. P₄. – NMB: Blm 108. M_{1/2}. – NMB: Blm 19 and 24. NMO: Blm 97, 100, 106, 113, 114 and 122. M₃. – NMB: Blm 121 and 191. NMO: Blm 94, 109, 111 and 112. SW-4: P⁴. – NMB: Blm 206. M¹. – NMB: Blm 28. M². – NMB: Blm 129. M³. – NMB: Blm 83. M_{1/2}. – NMB: Blm 22, 115 and 188. NMO: Blm 102 and 120. SW-5: P⁴. – NMO: Blm 103 (e). P₄. – NMO: Blm 126.

Table 29: Measurements of the M² of *Nesokerodon balmensis* n. sp. from Balm (Switzerland)

| SW | N | | range | \bar{X} | S | V |
|----|---|---------------------|-----------|-----------|------|-------|
| 1 | 2 | Sinus height | 1,17–1,33 | 1,25 | 0,11 | 9,05 |
| | 2 | Length | 1,36–1,42 | 1,39 | 0,04 | 3,05 |
| | 2 | Width | 1,08–1,25 | 1,17 | 0,12 | 10,32 |
| | 1 | Crown height | – | 1,58 | – | – |
| 2 | 5 | Sinus height | 1,20–1,33 | 1,27 | 0,06 | 4,46 |
| | 8 | Length | 1,33–1,58 | 1,46 | 0,08 | 5,24 |
| | 7 | Width | 1,25–1,50 | 1,33 | 0,10 | 7,26 |
| | 5 | Crown height | 1,42–2,00 | 1,70 | 0,21 | 12,21 |
| 3 | 1 | Sinus height | – | 1,08 | – | – |
| | 1 | Length | – | 1,50 | – | – |
| | 1 | Width | – | 1,33 | – | – |
| | 1 | Sinus length | – | 0,33 | – | – |
| | 1 | Extrasinus distance | – | 1,08 | – | – |
| | 1 | Crown height | – | 1,50 | – | – |
| 4 | 1 | Sinus height | – | 0,83 | – | – |
| | 1 | Length | – | 1,42 | – | – |
| | 1 | Width | – | 1,50 | – | – |
| | 1 | Sinus length | – | 0,50 | – | – |
| | 1 | Extrasinus distance | – | 1,00 | – | – |
| | 1 | Crown height | – | 1,17 | – | – |

Table 30: Measurements of the M³ of *Nesokerodon balmensis* n. sp. from Balm (Switzerland)

| SW | N | | range | \bar{X} | S | V |
|----|---|---------------------|-----------|-----------|------|-------|
| 1 | 6 | Sinus height | 1,00–1,33 | 1,18 | 0,15 | 12,84 |
| | 6 | Length | 1,16–1,25 | 1,19 | 0,04 | 3,05 |
| | 6 | Width | 1,08–1,25 | 1,19 | 0,08 | 6,32 |
| | 6 | Crown height | 1,00–1,67 | 1,38 | 0,26 | 18,67 |
| 2 | 2 | Sinus height | 0,83–1,08 | 0,96 | 0,18 | 18,51 |
| | 4 | Length | 1,17–1,42 | 1,23 | 0,13 | 10,14 |
| | 3 | Width | 1,25–1,33 | 1,27 | 0,05 | 3,62 |
| | 2 | Crown height | 1,25–1,33 | 1,29 | 0,06 | 4,39 |
| 3 | 2 | Sinus height | 0,58–1,08 | 0,83 | 0,35 | – |
| | 2 | Length | 1,33–1,42 | 1,38 | 0,06 | 4,63 |
| | 1 | Width | – | 1,44 | – | – |
| | 2 | Sinus length | 0,42–0,50 | 0,46 | 0,06 | 12,30 |
| | 1 | Extrasinus distance | – | 1,08 | – | – |
| | 2 | Crown height | 1,00–1,42 | 1,21 | 0,30 | – |
| 4 | 1 | Sinus height | – | 0,67 | – | – |
| | 1 | Length | – | 1,42 | – | – |
| | 1 | Width | – | 1,67 | – | – |
| | 1 | Sinus length | – | 0,58 | – | – |
| | 1 | Extrasinus distance | – | 1,17 | – | – |
| | 1 | Crown height | – | 1,08 | – | – |

Definition of the stage of wear. – Upper teeth: see p. 1005. Lower teeth: Some specimens in SW-1 have no pseudograben. For this reason they have no SW-2. For the rest see p. 1005.

Type locality. – Balm on the shores of the brook of Balm, Canton of Solothurn, Switzerland (see ERNI 1941, Fig. 3 and KFSNMB).

Stratum type. – See ERNI 1941, p. 211–212.

Stratigraphic range. – Rupelien, Lower Oligocene, assemblage zone of Balm (see ENGESSER & MAYO 1987).

Geographical distribution. – Central Europe.

Diagnosis. – *Nesokerodon* of small size. Upper teeth with shallow pseudograben and cusped 2 and 4 antyclines. P⁴: somewhat larger than M¹ or M². Antyclines 1 and 5 as cingulums, incipient I and IV synclines. The first one completely open. M¹–M² pentaantycline. Space between lingual and labial roots of crown inclined and cusped. Lower teeth: P₄ with shallow pseudograben; posterior part of the crown wider than the anterior. M_{1/2}: tetraantyclinid; with antesinusid; very shallow pseudograben and only in some part of the teeth; 2 and 4 antyclines cusped; 5 antyclinid as a cingulum. M₃: larger than M_{1/2}, antyclinid 4 more cusped than 2; antyclinid 5 generally as a cingulum. Average thickness of enamel border in the upper teeth: 0,04–0,08.

Table 31: Measurements of the D₄ and P₄ of *Nesokerodon balmensis* n. sp. from Balm (Switzerland)

| Tooth | SW | Sinusid height | Length | Width | Sinusid length | Extrasinusid distance | Crown height |
|----------------|----|----------------|--------|-----------|----------------|-----------------------|--------------|
| D ₄ | | 0,40 | 1,76 | 1,00–1,08 | 0,33–0,42 | 0,67 | 0,72 |
| P ₄ | 1 | 1,00 | 1,50 | 0,92 | – | – | 1,33 |
| P ₄ | 2 | 0,92 | – | 1,08 | – | – | 1,17 |
| P ₄ | 3 | 0,83 | 1,60 | 0,92 | 0,33 | 0,58 | 1,25 |
| P ₄ | 5 | 0,25 | 1,67 | 1,42 | 0,58 | 0,75 | 0,75 |

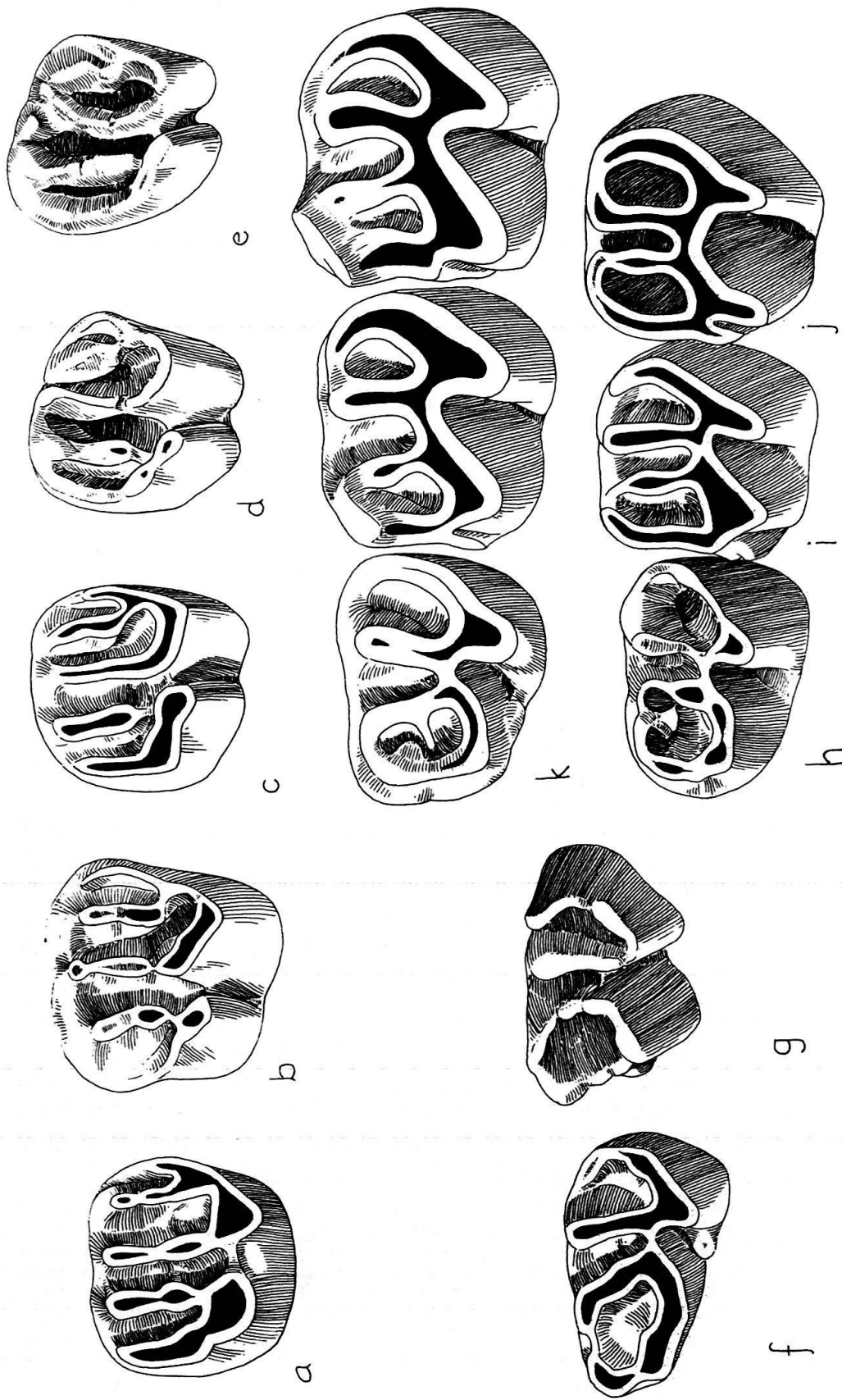

Fig. 18. *Nesokeroodon balmensis* n. sp. and *Nesokeroodon medius* (VIANEY-LIAUD 1976). *Nesokeroodon balmensis* n. sp.: a = NMB; Blm 82. D⁴ dex (invers.). Paratype. b = NMB; Blm 210. P⁴ sin. Holotype. c = NMB; Blm 204. M¹ sin. Paratype. d = NMB; Blm 88. M² sin. Paratype. e = NMB; Blm 25. M³ sin. Paratype. f = NMB; Blm 242. D₄ sin. g = NMB; Blm 190. M₃ dex (invers.). Paratype. h = NMB; Blm 108. P₄ sin. Paratype. i = NMB; Blm 100. M_{1/2} sin. Paratype. j = NMB; Blm 188. M_{1/2} sin. Paratype. Balm, Switzerland. *Nesokeroodon medius* (VIANEY-LIAUD 1976): k = LPVUM: PLA-24. P₄-M₂ sin. Holotype. La Plante 2, Quercy, France. - All figures × 12,5.

Differential diagnoses. – *Nesokerodon balmensis* n. sp. differs from *Nesokerodon nanus* (THALER 1969) in the:

- larger size,
- higher semihypsodonty,
- more detached presence of bunodont appearance,
- more developed syncline I in P⁴.

From *Nesokerodon medius* (VIANEY-LIAUD 1976) in the:

- smaller size,
- lower semihypsodonty,
- less reduced synclines,
- not so thick enamel borders,
- more detached presence of bunodont appearance,
- less developed pseudograben in M₁ and M₂.

Discussion. – VIANEY-LIAUD (1976, p.21) emended the diagnosis of *Elfomys* HARTENBERGER 1971 including in this genus *N. medius* and *N. balmensis* n. sp. (she could not separate these two last species). Unfortunately she excluded in this procedure some important characters of *Elfomys* s. st. or included other ones which do not contain the

Table 32: Measurements of the M_{1/2} of *Nesokerodon balmensis* n. sp. from Balm (Switzerland)

| SW | N | | range | \bar{X} | S | V |
|----|---|-----------------------|-----------|-----------|------|-------|
| 1 | 7 | Sinusid height | 1,08–1,50 | 1,33 | 0,15 | 11,50 |
| | 7 | Length | 1,42–1,58 | 1,49 | 0,06 | 3,71 |
| | 7 | Width | 0,92–1,08 | 0,99 | 0,07 | 7,28 |
| | 6 | Crown height | 1,25–1,75 | 1,57 | 0,18 | 11,39 |
| 2 | 9 | Sinusid height | 1,00–1,33 | 1,18 | 0,16 | 9,77 |
| | 9 | Length | 1,36–1,58 | 1,49 | 0,08 | 5,36 |
| | 9 | Width | 1,00–1,17 | 1,07 | 0,07 | 6,27 |
| | 8 | Crown height | 1,42–1,58 | 1,50 | 0,06 | 4,03 |
| 3 | 8 | Sinusid height | 0,92–1,33 | 1,07 | 0,12 | 11,17 |
| | 8 | Length | 1,42–1,58 | 1,50 | 0,06 | 4,33 |
| | 8 | Width | 1,00–1,17 | 1,11 | 0,08 | 6,86 |
| | 8 | Sinusid length | 0,33–0,50 | 0,45 | 0,06 | 13,27 |
| | 8 | Extrasinusid distance | 0,58–0,75 | 0,68 | 0,07 | 9,81 |
| | 8 | Crown height | 1,33–1,58 | 1,46 | 0,14 | 9,56 |
| 4 | 4 | Sinusid height | 0,67–1,00 | 0,83 | 0,15 | 18,15 |
| | 4 | Length | 1,32–1,67 | 1,49 | 0,14 | 9,54 |
| | 4 | Width | 1,25–1,42 | 1,33 | 0,05 | 5,21 |
| | 3 | Sinusid length | 0,58–0,67 | 0,61 | 0,05 | 8,52 |
| | 4 | Extrasinusid distance | 0,67–0,83 | 0,75 | 0,07 | 8,71 |
| | 4 | Crown height | 1,08–1,42 | 1,23 | 0,17 | 14,20 |
| 5 | 1 | Sinusid height | – | 0,25 | – | – |
| | 1 | Length | – | 1,58 | – | – |
| | 1 | Width | – | 1,75 | – | – |
| | 1 | Sinusid length | – | 0,83 | – | – |
| | 1 | Extrasinusid distance | – | 0,83 | – | – |
| | 1 | Crown height | – | 0,67 | – | – |

Table 33: Measurements of the M_3 of *Nesokerodon balmensis* n. sp. from Balm (Switzerland)

| SW | N | | range | \bar{X} | S | V |
|----|---|-----------------------|-----------|-----------|------|-------|
| 1 | 1 | Sinusid height | – | 1,33 | – | – |
| | 1 | Length | – | 1,50 | – | – |
| | 1 | Width | – | 1,00 | – | – |
| | 1 | Crown height | – | 1,50 | – | – |
| 2 | 2 | Sinusid height | 1,33–1,42 | 1,38 | 0,06 | 4,63 |
| | 2 | Length | 1,58–1,75 | 1,67 | 0,12 | 7,22 |
| | 2 | Width | 1,08–1,17 | 1,13 | 0,06 | 5,66 |
| | 2 | Crown height | – | 1,58 | – | – |
| 3 | 6 | Sinusid height | 0,92–1,17 | 1,06 | 0,09 | 8,08 |
| | 6 | Length | 1,33–1,59 | 1,47 | 0,10 | 6,92 |
| | 6 | Width | 1,00–1,50 | 1,18 | 0,19 | 16,39 |
| | 6 | Sinusid length | 0,36–0,58 | 0,48 | 0,09 | 19,21 |
| | 6 | Extrasinusid distance | 0,50–0,58 | 0,53 | 0,04 | 7,45 |
| | 6 | Crown height | 1,17–1,42 | 1,32 | 0,10 | 7,39 |

species of the Eocene at all (more details in MAYO 1987a). For this reason, and because the characters of *N. nanus*, *N. medius* or *N. balmensis* n. sp. fit together better with those of *Nesokerodon* SCHLOSSER 1884, they are included in this genus. The $M_{\frac{1}{2}}$ of the Holotype of *N. medius* VIANEY-LIAUD, (LPVUM, PLA 24) – the only specimen from the fissure filling of La Plante-2 which belongs without doubt to *N. medius* – appears larger and has a greater crown height than the teeth of *N. balmensis* n. sp. from Balm. The comparison by the Student-t test of the sample of *N. balmensis* n. sp. (27 specimens) with the type of *N. medius* for the length of $M_{\frac{1}{2}}$ (2 specimens), showed great significant differences. It is also necessary to take into account that the Pearson's coefficient of variation of *N. medius* from La Plante-2 for the $M_{\frac{1}{2}}$ (41 specimens) is 8,83% (after VIANEY-LIAUD 1976, p. 85, Table 20). However, the coefficient for the same teeth of *N. balmensis* n. sp. (29 specimens) is only 5,17. This result, using statistical methods, suggests that in the carstic fissure filling of La Plante-2 there is a heterochronic mixture of specimens of different ages. VIANEY-LIAUD (letter of 30.1.1985) wrote me that the measurements of Table 6 (1976, p. 32) belong to Balm and not to Montalbán.

Measurements in the tables: 27–33.

Statistical test in the tables: 54 and 56.

Nesokerodon aarwangensis n. sp.

Fig. 19

Synonymy. –

- 1914 *Nesokerodon quercyi* STEHLIN, p. 183.
- 1966 *Issiodoromys pseudanema* THALER, p. 203, Table 9.
- 1969 *Issiodoromys pseudanema* HUGUENEY, p. 200.
- 1976 *Issiodoromys quercyi* VIANEY-LIAUD, p. 60 in part, 68 and 70, Table 17, Fig. 35.
- 1983 *Issiodoromys quercyi* MAYO, p. 903, Fig. 55.

Holotype. – NMB: Aw 62, left maxillary fragment with D^4 – M^2 . M^1 in SW-2 and M^2 in SW-1.

Measurements of the Holotype. – Sinus height: $D^4 = 0,58$; $M^1 = 4,83$; $M^2 = > 4,00$. Length: $D^4 = 2,67$; $M^1 = 2,08$; $M^2 = 1,92$. Width: $D^4 = 1,92$; $M^1 = 1,83$; $M^2 = 1,50$. Si-

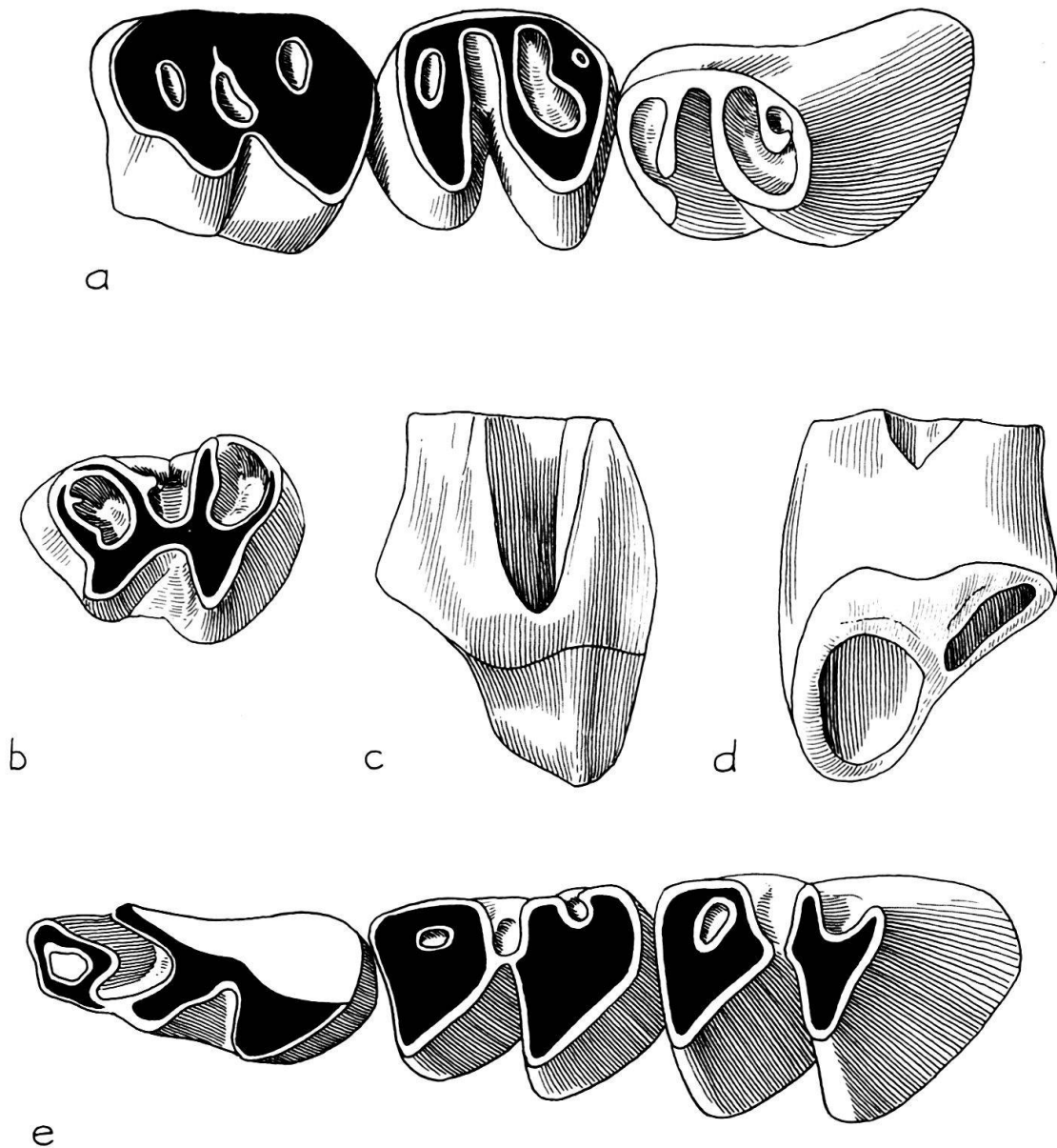

Fig. 19. *Nesokerodon aarwangensis* n. sp. a = NMB: Aw 62. D^4 - M^2 sin. Holotype. b = NMB: Aw 63. P_4 sin. Paratype. c = labial view. d = lingual view. e = NMB: Aw 61. D_4 - M_2 dex (invers.). Paratype. Aarwangen 1, Switzerland. – All figures $\times 12,5$.

nus length: $D^4 = 0,58$. Extrasinus distance: $D^4 = 1,08$. Crown height: $D^4 = 1,00$; $M^1 = 5,00$. Maxillary height in front of P^4 between alveolar border and infraorbital crest: 3,08.

Paratypes. – NMB: Aw 61; right mandibular fragment with D_4 - M_2 . M_1 in SW-3 and M_2 in SW-2. NMB: Aw 63 (P_4) in SW-3.

Type locality. – Aarwangen-1, (see KFSNMB).

Type formation. – Aarwangen Molasse (see MARTIN 1906, p. 98; HEIM & HARTMANN 1919, p. 68; BAUMBERGER 1927, p. 560 and HABICHT 1987, p. 8–11).

Stratigraphic range. – Oligocene, Lower “Chattien”, assemblage zone of Aarwangen-1 (see ENGESSER & MAYO 1987).

Geographical distribution. – Central Europe.

Diagnosis. – Teeth with high semihypsodonty. Upper teeth with very bent crown labially-lingually. Very high maxilla in front of P⁴. M¹–M² with very short labial crown height, relative to the lingual one. Very small lobules. IV syncline very reduced. II syncline without a labial aperture. Mandible with longitudinal masseteric ridge moderately well developed. Lower teeth lingually concave to the crown base. P₄ large and molars very inclined to forward.

Differential diagnosis. – *Nesokerodon aarwangensis* n. sp. differs from *Nesokerodon quercyi* in the following characters:

- more elevated maxillary height in front of P⁴,
- larger size of the teeth,
- higher semihypsodonty,
- labially-lingually more bent upper crown,
- wider sinus,
- IV syncline very reduced, better developed masseteric ridge on the mandible,
- more forwardly inclined lower teeth,
- presence of a marked angle between the anterior border of the crown and anterior root in the lower molars,
- deeper concavity on the lingual border of the lower molars,
- greater size of P₄,
- thicker cellular cement on the sinusid.

Table 34: Measurements of the cheek teeth of *Nesokerodon aarwangensis* n. sp. from Aarwangen-1 (Switzerland)

| Tooth | SW | Sinus(id) height | Length | Width | Sinus(id) length | Extrasinus(id) distance | Crown height |
|----------------|----|------------------|--------|--------|------------------|-------------------------|--------------|
| D ⁴ | – | 0,58 | 2,67 | 1,92 | 0,58 | 1,08 | 1,00 |
| M ¹ | 2 | 4,83 | 2,08 | 1,83 | – | – | 5,00 |
| M ² | 1 | – | 1,92 | 1,50 | – | – | – |
| D ₄ | – | 0,25 | ~ 3,17 | ~ 1,50 | – | – | 0,67 |
| P ₄ | 3 | 2,00 | 2,17 | 1,58 | 0,67 | 0,92 | 2,50 |
| M ₁ | 4 | 3,42 | 2,50 | 1,67 | 1,00 | 0,50 | 3,58 |
| M ₂ | 3 | 4,00 | 2,25 | 1,67 | – | – | 4,17 |

Discussion. – STEHLIN (1914, p.183) determined the Issidoromyinae material of Aarwangen-1 as *Nesokerodon quercyi* SCHLOSSER 1884. THALER (1966, p.203, Table 9) and HUGUENEY (1969, p.200) identified this material as *Issidoromys pseudanema* GERVAIS 1848–52 on the basis of its considerable crown height. VIANEY-LIAUD (1976, p.60, 68 and 70, Table 17, Fig. 35) and MAYO (1983, p.903, Fig. 55) considered that it belongs to *I. quercyi*. Nevertheless, the better preparation of the material allowed it to be described as a new species.

Measurements in the Table 34.

Oensingenomys n. gen.

Synonymy. – See type species.

Type species. – *Oensingenomys ravellensis* n. gen. n. sp.

Stratigraphic range. – Oligocene, Lower “Chattien”, from Oensingen to Boningen assemblage zones (see ENGESSER & MAYO 1897).

Geographical distribution. – Central Europe.

Diagnosis. – Semihypsodont Issiodoromyinae with strong sagittal rotation in the upper teeth. Very high maxilla dorsal to P^4 , but compressed on M^2 – M^3 . Deep and narrow infraorbital canal and with a high external ridge. Long palatine vault. Posterior border of incisive foramen in front of posterior prism of P^4 . Posterior palatine foramen in front of contact between M^2 and M^3 . Choanae opened in front of first prism of M^3 . Posterior maxillary foramen behind M^3 , relatively far from maxillar border. Upper teeth with strongly dissimilar abrasion. Tooth rows much more curved than in Nesokerodon. Distance between lingual and labial alveolar borders in M^2 – M^3 greater than in Nesokerodon. Lingual half of upper teeth in the early stage of wear more abraded than the opposite side. Occlusal surface convex in the labial half and concave in the lingual half. The antycline and syncline weakly worn. Labial border of upper crown and of lingual root very bent. Normal labial roots of upper teeth with the base in the lower part of the crown. Lingual roots very short, strongly bent and with a tendency to lamination. Crown base with a broad space between labial and lingual roots. Mandible: with slightly to moderately prominent anterior masseteric ridge, parallel to cheek teeth and hold of the alveolar border; broad to very broad ventral part of mandible below the masseteric ridge, owing to pneumatic process. Upper and lower angular masseteric ridges behind the anterior

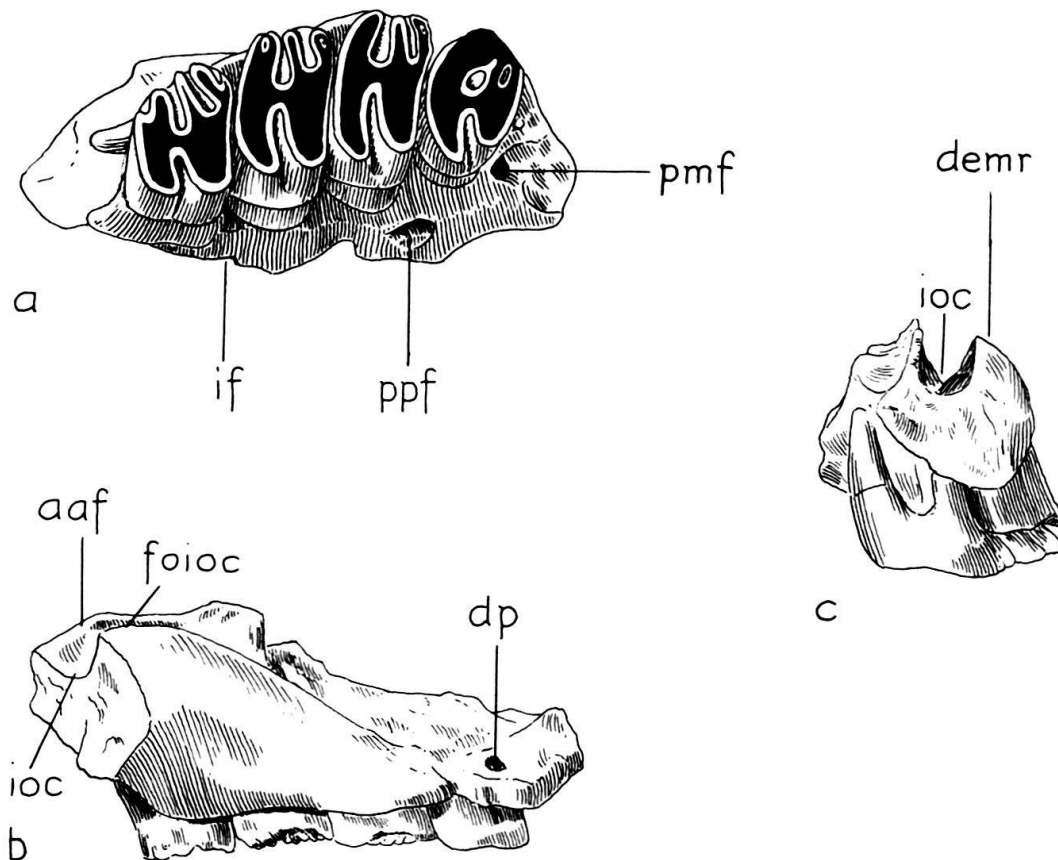

Fig. 20. *Oensingenomys ravelensis* n. gen. n. sp. NMB: UM 486. Left maxillary fragment with P^4 – M^3 . Holotype. a = ventral view. b = labial view. c = frontal view. Oensingen, Switzerland. – All figures $\times 3$.

masseteric ridge. Upper angular masseteric ridge with a very slight groove. M_3 with three roots. M_1 or M_2 with two or three roots. P_4 smaller than molars.

Differential diagnoses. – *Oensingenomys* n. gen. differs from *Issiodoromys* in the following characters:

- presence of semihypsodonty,
- different morphology of the maxilla,
- deeper and not vaulted infraorbital canal,
- presence of masseteric fossa on the ventral surface of the masseteric apophysis of the anterior zygomatic process,
- different length of the palatine vault,
- slightly different position of the posterior border of the incisive foramen,
- different position of the anterior border of the choanae,
- different position of the posterior palatine foramen,
- absence of posterior maxillary sulcus on the external border of the maxilla behind M^3 ,
- vertical external ridge of the infraorbital canal,
- presence of vertical foramen inside the masseteric fossa of the masseteric apophysis of the maxilla,
- compressed maxilla dorsally to M^2 – M^3 ,
- strongly curved tooth row,
- longer distance between the labial and lingual alveolar border of the maxilla beside M^2 ,
- different morphology of the mandible,
- absence of the long longitudinal masseteric ridge,
- absence of a deep sulcus above the masseteric ridge,
- absence of teeth with atrophied roots,
- presence of synclines and anticlines, very weakly worn in advanced stage of wear,
- unequal abrasion of the occlusal surface of the upper teeth,
- upper teeth much wider in fully worn stage,
- broader and shorter lobules.

From *Nesokerodon* in the:

- different morphology of the maxilla,
- much deeper and narrower infraorbital canal,
- larger maxillary height in front of P^4 ,
- low maxillary height dorsally to M^2 – M^3 ,
- different length of the palatine vault,
- slightly different position of the posterior border of the incisive foramen,
- different position of the anterior border of the choanae,
- different position of the posterior palatine foramen,
- absence of posterior maxillary sulcus on the external border of the maxilla behind M^3 ,
- very bent tooth row and labial alveolar border of the maxilla,
- larger distance between the lingual and labial alveolar border in the maxilla beside M^2 ,
- presence of a protuberance of bone on the labial border of the maxillary alveolus below the crown,
- different morphology of the mandible,
- different masseteric ridges,
- deep position of the masseteric ridge with reference to the alveolar border,

- very broad ventral part of the mandibular ramus below the masseteric ridge,
- pneumatic process of the mandible,
- absence of the shelflike masseteric ridge,
- horizontal position of the anterior masseteric ridge,
- different position of the lower angular masseteric ridge, and its absence below the anterior masseteric ridge,
- dissimilar abrasion of occlusal surface of the upper teeth,
- convex part of the occlusal crown surface on the synclines and antyclines,
- upper teeth much wider in advanced worn stage,
- presence of very weakly worn synclines and antyclines in the advanced state of wear,
- presence of a broad space below the upper crown, between the labial and lingual roots,
- more inclined labial border of the upper crown,
- more bent upper tooth rows,
- more bent lingual roots in the upper teeth,
- tendency towards lamination of the lingual roots of the upper teeth,
- more concave or laminated lingual roots in the upper teeth,
- absence of barfel form in the crown of the upper teeth,
- labial roots of the upper teeth with their base in the lower part of crown,
- M_3 with three roots,
- M_1 and M_2 with two or three roots.

Oensingenomys ravelensis n. gen. n. sp.

Fig. 20–21

Synonymy. –

- 1914 *Nesokerodon minor* STEHLIN, p. 18.
 1951 *Issiodoromys minor* STEHLIN, p. 71 and 72, Fig. 90 and 92.
 1966 *Issiodoromys minor* THALER, p. 201 and 203, Table 9.
 1976 *Issiodoromys* cf. *pauffiensis* VIANEY-LIAUD, p. 55 and 57, Table 13b, in part; non Fig. 32a, b and d; only Fig. 32c.
 1981 *Issiodoromys minor* HUGUENEY, p. 64.
 1982 *Issiodoromys* aff. *pauffiensis* VIANEY-LIAUD, p. 691.
 1982 *Issiodoromys minor* MAYO, p. 710.
 1983 *Issiodoromys minor* MAYO, p. 905 and 907.
 1984 *Issiodoromys pauffiensis* MAYO, p. 26, in: ENGESSER et al.

Table 35: Measurements of the P^4 of *Oensingenomys ravelensis* n. gen. n. sp. from Oensingen (Switzerland)

| SW | N | | range | \bar{X} | S | V |
|----|---|---------------------|-----------|-----------|------|-------|
| 3 | 1 | Sinus height | – | 1,33 | – | – |
| | 1 | Length | – | 1,75 | – | – |
| | 1 | Width | – | 1,92 | – | – |
| | 1 | Sinus length | – | 0,83 | – | – |
| | 1 | Extrasinus distance | – | 1,08 | – | – |
| | 1 | Crown height | – | 1,75 | – | – |
| 4 | 2 | Sinus height | – | 0,50 | – | – |
| | 2 | Length | 1,83–1,92 | 1,88 | 0,06 | 3,39 |
| | 2 | Width | 2,25–2,42 | 2,33 | 0,12 | 5,15 |
| | 2 | Sinus length | – | 1,00 | – | – |
| | 2 | Extrasinus distance | 1,25–1,33 | 1,29 | 0,06 | 4,39 |
| | 2 | Crown height | 0,92–1,17 | 1,05 | 0,18 | 16,92 |

Table 36: Measurements of the $M^{1/2}$ and M^3 of *Oensingomys ravellensis* n. gen. n. sp. from Oensingen (Switzerland)

| Tooth | SW | N | | range | \bar{X} | S | V |
|-----------|----|---|---------------------|-----------|-----------|------|------|
| $M^{1/2}$ | 2 | 1 | Sinus height | – | 2,42 | – | – |
| | | 1 | Length | – | 1,50 | – | – |
| | | 1 | Width | – | 1,67 | – | – |
| | | 1 | Crown height | – | 2,75 | – | – |
| $M^{1/2}$ | 3 | 1 | Sinus height | – | 1,50 | – | – |
| | | 1 | Length | – | 1,75 | – | – |
| | | 1 | Width | – | 2,08 | – | – |
| | | 1 | Sinus length | – | 1,00 | – | – |
| | | 1 | Extrasinus distance | – | 1,08 | – | – |
| | | 1 | Crown height | – | 2,08 | – | – |
| $M^{1/2}$ | 4 | 4 | Sinus height | 0,33–0,58 | 0,44 | 0,13 | – |
| | | 4 | Length | 1,75–1,92 | 1,83 | 0,07 | 3,79 |
| | | 4 | Width | 2,67–2,92 | 2,81 | 0,10 | 3,70 |
| | | 4 | Sinus length | 1,33–1,58 | 1,48 | 0,11 | 7,13 |
| | | 4 | Extrasinus distance | 1,25–1,33 | 1,31 | 0,04 | 3,05 |
| | | 4 | Crown height | 0,58–1,08 | 0,83 | 0,24 | – |
| M^3 | 2 | 1 | Sinus height | – | 1,75 | – | – |
| | | 1 | Length | – | 1,50 | – | – |
| | | 1 | Width | – | 1,42 | – | – |
| | | 1 | Crown height | – | 2,25 | – | – |

Holotype. – NMB: UM 486, left maxillary fragment with P^4 – M^3 . All teeth in SW-3.

Measurements of the Holotype. – Sinus height: P^4 = 0,50; M^1 = 0,58; M^2 = 0,50; M^3 = 0,33. Length: P^4 = 1,92; M^1 = 1,83; M^2 = 1,83; M^3 = 1,83. Width: P^4 = 2,42; M^1 = 2,67; M^2 = 2,83; M^3 = 2,33. Sinus length: P^4 = 1,00; M^1 = 1,33; M^2 = 1,50; M^3 = 0,92. Extrasinus distance: P^4 = 1,33; M^1 = 1,33; M^2 = 1,33; M^3 = 1,25. Crown height: P^4 – M^3 = 7,17. Distance between lingual and labial alveolar borders over M^2 : 3,83. The same measurements dorsally between the wall of the skull and the labial maxillary border: 2,50. Width of the infraorbital canal: 0,83. Anterior border of the alveolar foramen dorsally in near position to lower anterior crown border of P^4 . Height of the maxilla in front of P^4 between the alveolar border and crest of the infraorbital canal: 3,58. Frontal depth of the infraorbital canal (without fossa): 0,92.

Paratypes. – All in the collection of the NMB. D_4 . – UM 7163. SW-1: P_4 . – UM 6855. SW-3: P^4 . – UM 2189. M^1 . – UM 491, UM 7164f, M^2 . – UM 7165. $M_{1/2}$. – UM 468, 492, 2193, 6853 and 6854. SW-4: $M_{1/2}$. – UM 496 and 2192. Maxillary fragments: UM 226 (P^4 – M^2 : in SW-3) and UM 6851 (M^2 – M^3 in SW-2). Mandibular fragments: UM 2929

Table 37: Measurements of the D_4 and P_4 of *Oensingomys ravellensis* n. gen. n. sp. from Oensingen (Switzerland)

| Tooth | SW | Sinusid height | Length | Width | Sinusid length | Extrasinusid distance | Crown height |
|-------|----|----------------|--------|-------|----------------|-----------------------|--------------|
| D_4 | – | – | 2,87 | 1,25 | 0,42 | 0,75 | – |
| P_4 | 1 | 1,42 | 1,42 | 0,92 | – | – | 1,92 |
| P_4 | 2 | 1,17 | 1,67 | 1,25 | – | – | 1,58 |
| P_4 | 3 | 1,08 | 1,75 | 1,33 | 0,58 | 0,67 | 1,42 |
| P_4 | 4 | 0,50 | 2,00 | 1,50 | 1,16 | 0,58 | 1,17 |

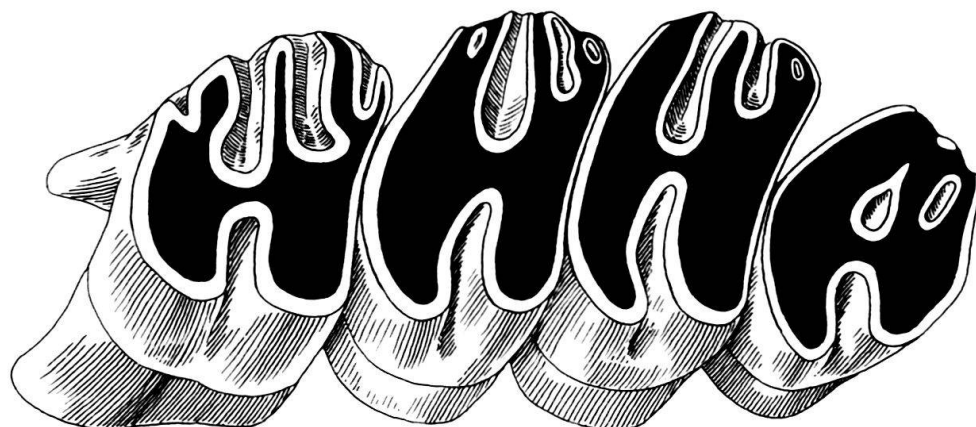

Fig. 21. *Oensingenomys ravelensis* n. gen. n. sp. NMB: UM 486. P⁴-M³ sin. Holotype. Oensingen, Switzerland. - × 12,5.

(P₄-M₃: P₄ and M₃ in SW-3; M₂ in SW-4; M, f); UM 495 (P₄-M₁: P₄ in SW-2 and M₂ in SW-3).

Hypodigm. - In addition to the Holotype and Paratype the specimen UM 228 f.

Type locality. - Oensingen-Ravellen (Canton of Solothurn, Switzerland). See STEHLIN (1914, p. 180); BAUMBERGER (1923, p. 36-38, Fig. 15); MAYO (1980, p. 1096-97, Fig. 1 and 1982, p. 714-18, Fig. 8 and 9).

Type formation. - Oensingen limestone. See BAUMBERGER 1923, p. 36-38 and 1927, p. 554-56, Fig. 4 and 5; WAIBEL & BURRI 1961, p. 187-88 and MAYO 1980, p. 1096-97, Fig. 1 and 1982, p. 714-18, Fig. 9.

Stratum type. - Lacustrine limestone of brown colour with 2,5 m of thickness. 2,3 m above the Eocene siderolitic Formation.

Stratigraphic range. - Oligocene, Lower "Chattien", assemblage zone of Oensingen (see ENGESSER & MAYO 1987).

Geographical distribution. - Faunal province of Switzerland and Savoy.

Diagnosis. - Species of small size and medium semihypsodonty. Maxilla with a very deep infraorbital canal. Infraorbital canal with a deep fossa in its base. Anterior alveolar foramen partially open at the base of the canal, inside the anterior border of the fossa. Anterior alveolar foramen dorsal to base of anterior border of P⁴. Labial alveolar border of maxilla almost parallel to occlusal surface of M²-M³. Sinus or sinusid without cellular cement. Lingual roots anterior-posteriorly narrow.

Discussion. - STEHLIN (1914, p. 18 and 1951, p. 71-72, Fig. 90 and 92) determined the material of *Oensingenomys ravellensis* n. gen. n. sp. as *Nesokerodon* or *Issiorodomys minor* SCHLOSSER 1884. He described the strong increase of the occlusal surface in the upper worn teeth as a normal sagittal rotation of the semihypsodontic teeth. THALER (1966, p. 201 and 203, Table 9) maintained this opinion. VIANEY-LIAUD (1976, p. 55, 57 and 59, Fig. 32 and Table 13b) observed that the teeth of Oensingen are greater in size than those of *Nesokerodon minor*. For this reason she considered with some doubt, this material as *Issiorodomys* cf. *pauffiensis* VIANEY-LIAUD 1976. HUGUENEY (1981, p. 64) identified it as *I. minor*. Later VIANEY-LIAUD (1982, p. 691) determined this material as *I. aff. pauffiensis*. MAYO (1982, p. 710 and 1983, p. 905 and 907) indicated that it belonged to a different

Table 38: Measurements of the $M_{1/2}$ and M_3 of *Oensingenomys ravellensis* n. gen. n. sp. from Oensingen (Switzerland)

| Tooth | SW | N | | range | \bar{X} | S | V |
|-----------|----|---|-----------------------|-----------|-----------|------|-------|
| $M_{1/2}$ | 3 | 6 | Sinusid height | 1,58–2,08 | 1,79 | 0,17 | 9,59 |
| | | 6 | Length | 1,68–2,08 | 1,96 | 0,15 | 7,64 |
| | | 6 | Width | 1,33–2,33 | 1,63 | 0,37 | – |
| | | 6 | Sinusid length | 0,58–0,83 | 0,72 | 0,10 | 14,51 |
| | | 6 | Extrasinusid distance | 0,67–0,83 | 0,73 | 0,06 | 8,80 |
| | | 6 | Crown height | 1,92–2,42 | 2,16 | 0,18 | 8,27 |
| $M_{1/2}$ | 4 | 3 | Sinusid height | 0,75–1,25 | 1,00 | 0,25 | – |
| | | 3 | Length | 2,00–2,17 | 2,08 | 0,09 | 4,08 |
| | | 3 | Width | 1,60–2,00 | 1,84 | 0,21 | 11,50 |
| | | 3 | Sinusid length | 0,83–1,17 | 1,03 | 0,18 | 17,16 |
| | | 3 | Extrasinusid distance | 0,75–0,92 | 0,81 | 0,10 | 12,17 |
| | | 2 | Crown height | 1,08–1,50 | 1,29 | 0,30 | – |
| M_3 | 3 | 1 | Sinusid height | – | 1,00 | – | – |
| | | 1 | Length | – | 2,25 | – | – |
| | | 1 | Width | – | 1,83 | – | – |
| | | 1 | Sinusid length | – | 0,92 | – | – |
| | | 1 | Extrasinusid distance | – | 0,83 | – | – |
| | | 1 | Crown height | – | 1,08 | – | – |

taxon to *I. minor*. MAYO (1984, p. 26, in: ENGESSER et al.) considered it may be *I. pauffiensis* VIANEY-LIAUD, 1976. Nevertheless, a painstaking preparation and more detailed examination of this material has permitted its separation as a new genus and species.

Measurements in the Tables 35–38.

Oensingenomys huerzeleri n. sp.

Fig. 22

Derivatio nominis. – After Dr. Johannes Hürzeler (Basel), collector of the material.

Holotype. – NMB: UM 3775, left maxillary fragment with P^4 – M^3 , P^4 and M^3 in SW-2 and M^1 and M^2 in SW-3.

Measurements of the Holotype. – Sinus height: $P^4 = 2,42$; $M^1 = 2,50$; $M^2 = 3,17$; $M^3 = 2,58$. Length: $P^4 = 2,08$; $M^1 = 2,25$; $M^2 = 2,42$; $M^3 = 1,75$. Width: $P^4 = 1,92$; $M^1 = 2,42$; $M^2 = 2,50$; $M^3 = 1,92$. Sinus length: $P^4 = 0,75$; $M^1 = \sim 1,17$; $M^2 = \sim 1,17$. Extrasinusid distance: $M^1 = 1,17$; $M^2 = 1,25$. Length of P^4 – $M^3 = 8,50$.

Paratypes. – All the material in the collections of NMB. SW-2: $M^{1/2}$. – UM 5052. SW-3: P^4 . – UM 5065 and 6038 f. M^3 . – UM 3780. $M^{1/2}$. – UM 5052. SW-4: $M^{1/2}$. – UM 3779, 5056 f, 5063 f, 5064 f and 5066 f. Mandibular fragments: UM 5051 (P_4 – M_3 ; P_4 and M_3 in SW-3; M_1 and M_2 in SW-4). UM 3776 (P_4 – M_3 ; P_4 and M_3 in SW-3 and M_1 and M_2 in SW-4).

Hypodigm. – In addition to the Holotype and Paratype the specimen UM 6039 (D₄e).

Type locality. – Boningen (Canton of Solothurn, Switzerland). See KFSNMB.

Type formation. – Aarwangen Molasse (see HABICHT 1987, p. 8–11).

Stratum type. – Green-gray lacustrine marls bed of ca. 40 cm thickness, with mollusc shells, below a hard limestone bed of 50 cm thickness.

Table 39: Measurements of the upper check teeth of *Oensingenomys huerzeleri* n. sp. from Boningen (Switzerland)

| Tooth | SW | N | | range | \bar{X} | S | V |
|------------------|----|---|---------------------|-----------|-----------|------|-------|
| P ⁴ | 3 | 2 | Sinus height | 2,42–3,42 | 2,92 | 0,71 | – |
| | | 2 | Length | 2,08–2,17 | 2,13 | 0,06 | 2,99 |
| | | 2 | Width | 1,92–2,08 | 2,00 | 0,11 | 5,66 |
| | | 2 | Sinus length | 0,75–0,92 | 0,84 | 0,12 | 14,40 |
| | | 1 | Extrasinus distance | – | 1,08 | – | – |
| | | 1 | Crown height | – | 2,92 | – | – |
| M ^{1/2} | 3 | 2 | Sinus height | 2,50–3,17 | 2,84 | 0,47 | 16,71 |
| | | 2 | Length | 2,25–2,42 | 2,34 | 0,12 | 5,15 |
| | | 2 | Width | 2,42–2,50 | 2,46 | 0,06 | 2,30 |
| | | 2 | Sinus length | – | 1,17 | – | – |
| | | 2 | Extrasinus distance | 1,17–1,25 | 1,21 | 0,06 | 4,68 |
| | | 2 | Crown height | 3,42–3,92 | 3,67 | 0,35 | 9,63 |
| M ^{1/2} | 4 | 5 | Sinus height | 1,25–3,00 | 2,33 | 0,70 | – |
| | | 5 | Length | 2,25–2,50 | 2,38 | 0,10 | 4,03 |
| | | 1 | Width | – | 2,83 | – | – |
| | | 3 | Sinus length | 1,42–1,50 | 1,45 | 0,03 | 3,19 |
| | | 1 | Extrasinus distance | – | 1,42 | – | – |
| | | 5 | Crown height | 1,75–3,50 | 2,80 | 0,69 | – |
| M ³ | 2 | 1 | Sinus height | – | 2,58 | – | – |
| | | 1 | Length | – | 1,75 | – | – |
| | | 1 | Width | – | 1,92 | – | – |
| | | 1 | Crown height | – | 3,00 | – | – |

Stratigraphic range. – Oligocene, top of Lower “Chattien”, assemblage zone of Boningen (see ENGESSER & MAYO 1987).

Geographical distribution. – Central Europe.

Diagnosis. – Species of large size and high semihypsodonty. Labial border of the maxilla in front of M²–M³ not parallel to occlusal surface. Upper teeth: with very broad and short lobules; very broad space below the crown between labial and lingual roots and very laminated lingual roots. Sinus relatively open and with cellular cement. Mandible with anterior masseteric ridge of moderate size (below P₄ and M₁) in very deep position relating to the alveolar border. Very broad ventral part of the mandible below the masseteric ridge owing to pneumatic process.

Differential diagnosis. – *O. huerzeleri* n. sp. differs from *O. ravellensis* n. gen. n. sp. in the following characters:

- larger size,
- higher semiphypsodonty,
- different labial border of the maxilla in front of M²–M³,
- broader space below the crown between labial and lingual roots,
- more laminated lingual roots,
- sinus with cellular cement,
- more opened sinus,
- longer anterior masseteric ridge,
- more pneumatic mandible.

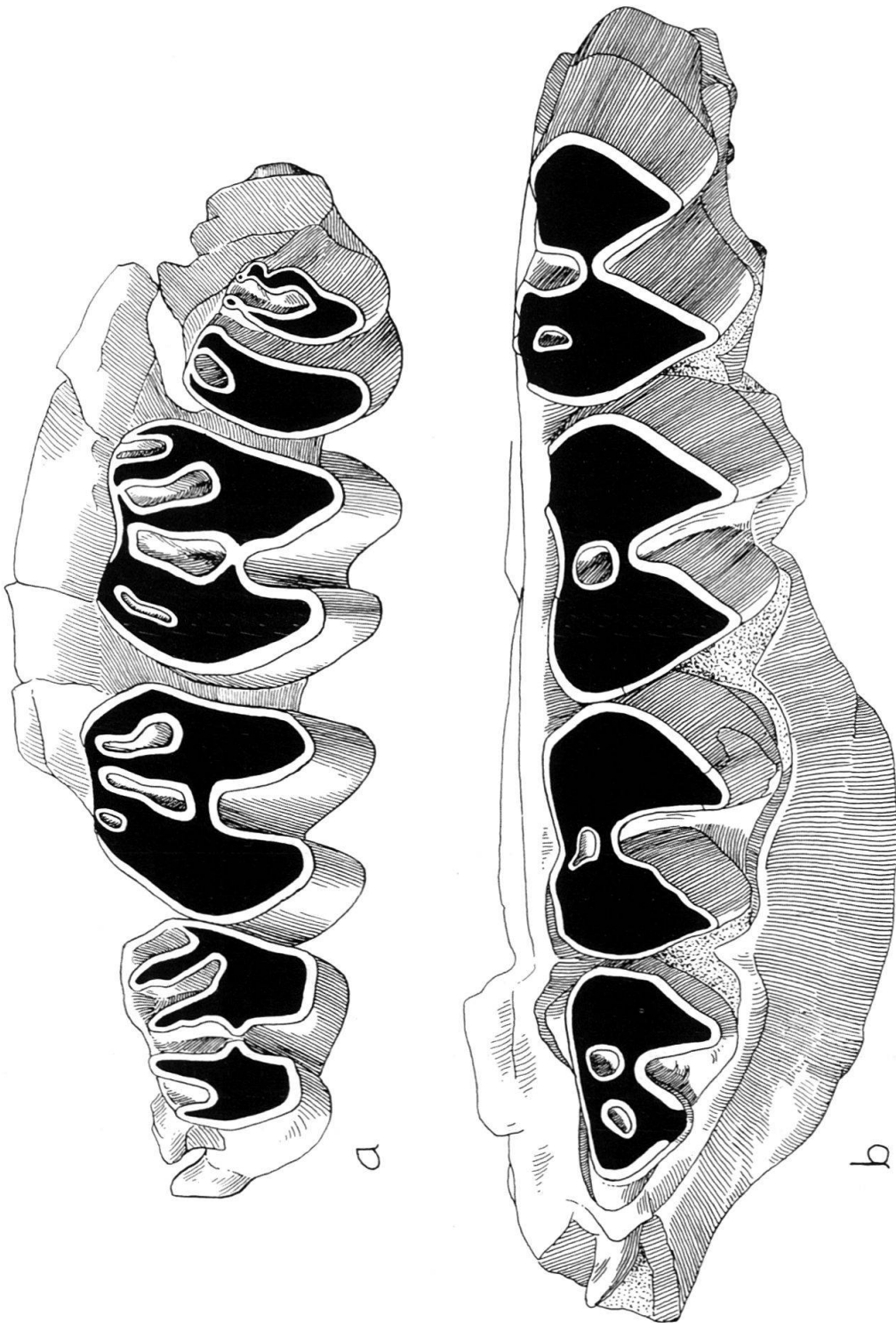

Fig. 22. *Oensingenomys huerzeleri* n. sp. a = NMB: UM 3775. Left maxillary fragment with P⁴-M³. Holotype. b = NMB: UM 5051. P₄-M₃ sin. Paratype. Boningen, Switzerland. - All figures × 12.5.

Discussion. – STEHLIN identified the teeth of this species as *Issiodoromy quercyi* SCHLOSSER 1884 (1928, labels). THALER (1966, p. 203) – with doubts – HUGUENEY (1969, p. 200, Fig. 116) and VIANEY-LIAUD (1976, p. 60, 67 and 69, Table 16d, Fig. 34 and 1979, p. 215 and 227) were of the same opinion. Nevertheless, a painstaking preparation of the material permitted its separation as a new species.

Measurements in the Tables 39–40.

Table 40: Measurements of the lower cheek teeth of *Oensingenomys huerzelei* n. sp. from Boningen (Switzerland)

| Tooth | SW | N | | range | \bar{X} | S | V |
|------------------|----|---|-----------------------|-----------|-----------|------|-------|
| P ₄ | 3 | 2 | Sinusid height | 0,92–1,58 | 1,25 | 0,47 | – |
| | | 2 | Length | 1,83–2,08 | 1,96 | 0,18 | 9,04 |
| | | 2 | Width | 1,42–1,50 | 1,46 | 0,06 | 3,87 |
| | | 2 | Sinusid length | – | 0,83 | – | – |
| | | 2 | Extrasinusid distance | 0,42–0,58 | 0,50 | 0,11 | – |
| | | 2 | Crown height | 1,58–2,00 | 1,79 | 0,30 | 16,59 |
| P ₄ | 4 | 1 | Sinusid height | – | 1,25 | – | – |
| | | 1 | Length | – | – | – | – |
| | | 1 | Width | – | 1,58 | – | – |
| | | 1 | Sinusid length | – | 0,83 | – | – |
| | | 1 | Extrasinusid distance | – | 0,50 | – | – |
| | | 1 | Crown height | – | – | – | – |
| M _{1/2} | 2 | 1 | Sinusid height | – | 3,00 | – | – |
| | | 1 | Length | – | 2,75 | – | – |
| | | 1 | Width | – | 1,92 | – | – |
| | | 1 | Sinusid length | – | 1,17 | – | – |
| | | 1 | Extrasinusid distance | – | 0,75 | – | – |
| | | 1 | Crown height | – | 3,25 | – | – |
| M _{1/2} | 3 | 2 | Sinusid height | 1,92–2,92 | 2,42 | 0,71 | – |
| | | 2 | Length | 2,42–2,50 | 2,46 | 0,06 | 2,30 |
| | | 2 | Width | – | 1,83 | – | – |
| | | 2 | Sinusid length | 1,08–1,17 | 1,13 | 0,06 | 5,66 |
| | | 2 | Extrasinusid distance | – | 0,75 | – | – |
| | | 2 | Crown height | 2,17–3,17 | 2,67 | 0,71 | – |
| M _{1/2} | 4 | 7 | Sinusid height | 1,17–2,50 | 1,77 | 0,56 | – |
| | | 7 | Length | 2,33–2,75 | 2,50 | 0,15 | 5,88 |
| | | 7 | Width | 1,75–2,08 | 1,89 | 0,12 | 6,09 |
| | | 7 | Sinusid length | 1,08–2,25 | 1,38 | 0,41 | – |
| | | 7 | Extrasinusid distance | 0,42–0,83 | 0,62 | 0,13 | – |
| | | 6 | Crown height | 1,58–3,00 | 2,25 | 0,56 | – |
| M ₃ | 3 | 2 | Sinusid height | 2,17–2,75 | 2,46 | 0,41 | 16,67 |
| | | 2 | Length | 2,42–2,67 | 2,55 | 0,18 | 6,95 |
| | | 2 | Width | – | 2,00 | – | – |
| | | 2 | Sinusid length | 1,00–1,08 | 1,04 | 0,06 | 5,44 |
| | | 2 | Extrasinusid distance | 0,50–0,75 | 0,63 | 0,18 | – |
| | | 1 | Crown height | – | 3,17 | – | – |

Subfamily *Archaeomyinae* LAVOCAT 1952

Genus *Toeniodus* POMEL 1854

Synonymy. –

1854 *Toeniodus* POMEL, p. 36 (correct original spelling Art. 32 cii).

1859 *Taeniodus* GERVAIS, p. 31 (incorrect emendation of the original spelling).

- 1891–93 *Theridomys* ZITTEL, p. 554, in part.
 1904 *Taeniodus* PALMER, p. 659.
 1904 *Toeniodus* PALMER, p. 681.
 1941 *Trechomys* WINGE, p. 117.
 1941 *Pararchaeomys* STEHLIN, p. 213.
 1951 *Taeniodus* SCHAUB, p. 253, 364 and 365, in: STEHLIN & SCHAUB.
 1952 *Taeniodus* LAVOCAT, p. 79 and 81.
 1953 *Taeniodus* SCHAUB, p. 41, Fig. 22 and 23, non Fig. 24.
 1958 *Taeniodus* SCHAUB, p. 701.
 1966 *Taeniodus* THALER, p. 51, 59 and 74.
 1972 *Taeniodus* BAHLO, p. 18.
 1975 *Taeniodus* BAHLO, p. 18.
 1979 *Archaeomys* (*Taeniodus*) VIANEY-LIAUD, p. 198.

Stratigraphic range. – Oligocene, Rupelian to Lower “Chattien”. From Balm to Grenchen-I assemblage zones (see ENGESSER & MAYO 1987).

Geographical distribution. – Central and West Europe.

Previous diagnoses. – See POMEL (1854, p. 37); LAVOCAT (1953, p. 79) and SCHAUB (1958, p. 701).

Emended diagnosis. – Maxilla without infraorbital canal. Anterior alveolar foramen dorsal to P⁴ and open laterally; without depressions or nutritive foramina. Infraorbital foramen oval, without pinching. Narrow ascending ramus of anterior zygomatic process with slightly concave anterior border. Palatine vault very short. Incisive foramen very long with its posterior border in front of I syncline of P⁴. Posterior palatine foramen in front of the posterior prism of M¹ and with or without channel opening into the choanae. Choanae opened in front of anterior border of M². With posterior maxillary foramen. Mandible with small shelflike masseteric ridge below P₄ and pronounced low angular ridge. Upper angular masseteric ridge slightly represented and with a groove. Anterior border of coronoid process in front of M₃. Condylod process much higher than cheek teeth. Upper teeth penta or hexaantycline. Lower ones pentaantyclinid. Semihypsodontic teeth with wide synclines or synclinids and fine antyclines or antyclinids in unworn stage. II syncline tubular. Other synclines pseudolaminar or laminar. Sinus very prolonged, anteroversus and ends generally in front of I syncline. I syncline frequently longer than II. III syncline open to labial and posterior borders of crown. Posterior opening generally deeper than labial on M¹ and M². In unworn stage I synclinid open or closed to anterior border of crown. II open to anterior border and closed to the lingual. III lingually open and sometimes superficially joined with II. IV fused with sinusid in a graben or united in a pseudograben. D₄ with graben and anterograben or antero-pseudograben. Upper teeth with two small labial roots and one lingual root. Lower teeth with two small anterior roots and one posterior root.

Differential diagnoses. – *Toeniodus* differs from *Blainvillimys* in the following characters:

- different morphology of the maxilla,
- strongly expanded labial border of the maxilla in front of P⁴,
- shorter palatine vault,
- presence of sulcus in palatine vault,
- different position of the posterior border of the incisive foramen,
- different morphology of the incisive foramen,

- different position of the posterior palatine foramen
- presence of posterior maxillary foramen,
- absence of an infraorbital canal,
- absence of depression associated with anterior alveolar foramen,
- absence of nutritive foramina associated with the depression and the anterior alveolar foramen,
- finer antyclines and antyclinids of the teeth in the unworn stage,
- finer anterior borders of enamel in the antyclines of the upper teeth,
- different morphology of D^4 ,
- finer posterior borders of enamel in the antyclinids of the lower teeth,
- longer sinus in the upper teeth,
- different morphology of the mandible,
- different inclination of the anterior shelflike masseteric ridge,
- different position of the union between the anterior shelflike masseteric ridge and the upper angular masseteric ridge,
- different morphology of the D_4 ,
- presence of graben or deep pseudograben in the lower teeth,
- fusion of the IV synclinid with the sinusid in a graben or joined in a pseudograben,
- constant presence of the I synclinid in unworn or moderately worn teeth.

From *Archaeomys* (n. subg.) or primitive Archaeomyids in the:

- different morphology of the maxilla,
- different infraorbital foramen,
- much shorter palatine vault,
- longer incisive foramen,
- different position of the posterior palatine foramen,
- weak upper masseteric ridge,
- different position of the shelflike masseteric ridge,
- different position of the anterior border of the coronoid process,
- different condyloid process,
- lower crown height of the teeth,
- different morphology of the D^4 ,
- more open syncline of the upper teeth in the unworn stage,
- a generally different position of the end of the sinus,
- deeper aperture of the III syncline on the labial border of the crown,
- shallower aperture of the III syncline on the posterior border of the crown,
- different morphology of the D_4 ,
- the fusion of the IV synclinid and the sinusid in a graben or joined in a pseudograben,
- constant presence of the I synclinid in the slightly or moderately worn lower teeth.

Toeniodus curvistriatus POMEL 1854

Fig. 23–30

Synonymy. –

1839 ?*Echimys curvistriatus* LAIZER & PARIEU, p. 25, nomen nudum.

1854 *Toeniodus curvistriatus* POMEL, p. 36.

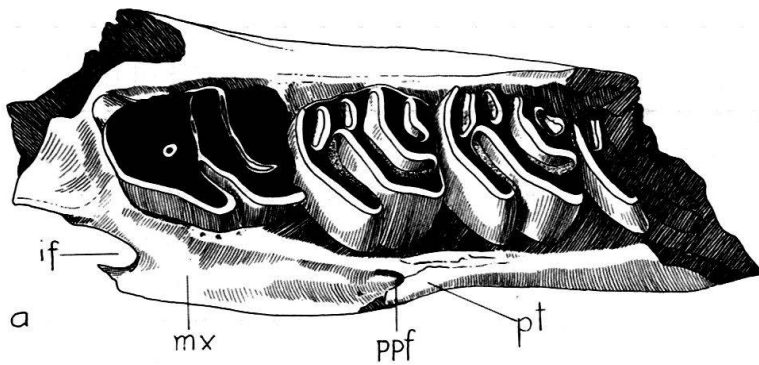
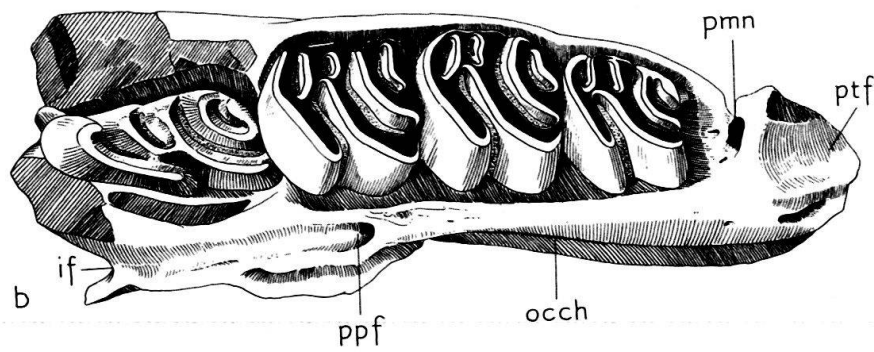
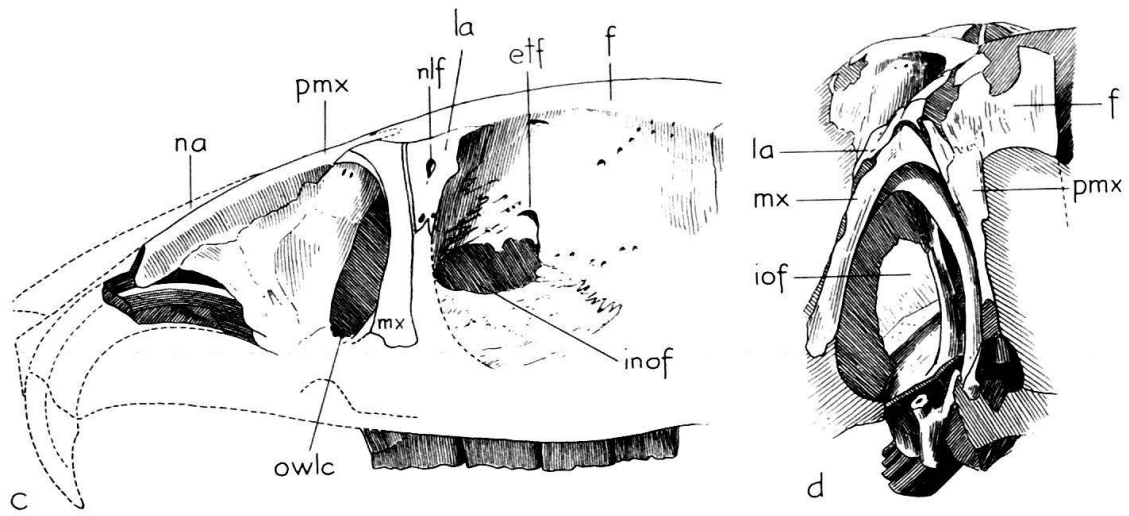

Fig. 23. *Toeniodus curvistriatus* POMEL 1854. MNHNP: THE-1. Skull fragment with teeth row. a = D⁴-M³ f. sin. b = P⁴-M³ dex (invers.). c = lateral view. d = frontal view. Paralectotype. Sauvetat, France. - All figures × 4.

- 1859 *Taeniodus curvistriatus* GERVAIS, p. 31.
 1891 *Theridomys curvistriatus* ZITTEL, p. 554.
 1904 *Taeniodus curvistriatus* PALMER, p. 659.
 1904 *Toeniodus curvistriatus* PALMER, p. 681.
 1941 *Trechomys curvistriatus* WINGE, p. 117.
 1951 "*Pararchaeomys*" *curvistriatus* SCHAUB, p. 365, in: STEHLIN & SCHAUB.
 1951 non *Taeniodus curvistriatus* SCHAUB, p. 79, 252, 365, 415 and 416, Fig. 106 and 107, in: STEHLIN & SCHAUB.
 1952 *Taeniodus curvistriatus* LAVOCAT, p. 79, Plate 13, Fig. 6.
 1953 non *Taeniodus curvistriatus* SCHAUB, p. 41, Fig. 22 and 23.
 1966 *Taeniodus curvistriatus* THALER, p. 74 and 75 in part.
 1966 *Blainvillimys* aff. *blainvillei* THALER, p. 75.
 1979 *Taeniodus curvistriatus* VIANEY-LIAUD, p. 198 non 227.
 1979 *Archaeomys* (*Taeniodus*) *curvistriatus* VIANEY-LIAUD, p. 232.
 1981 *Taeniodus curvistriatus* HUGUENEY, p. 334, in: BRUNET et al.

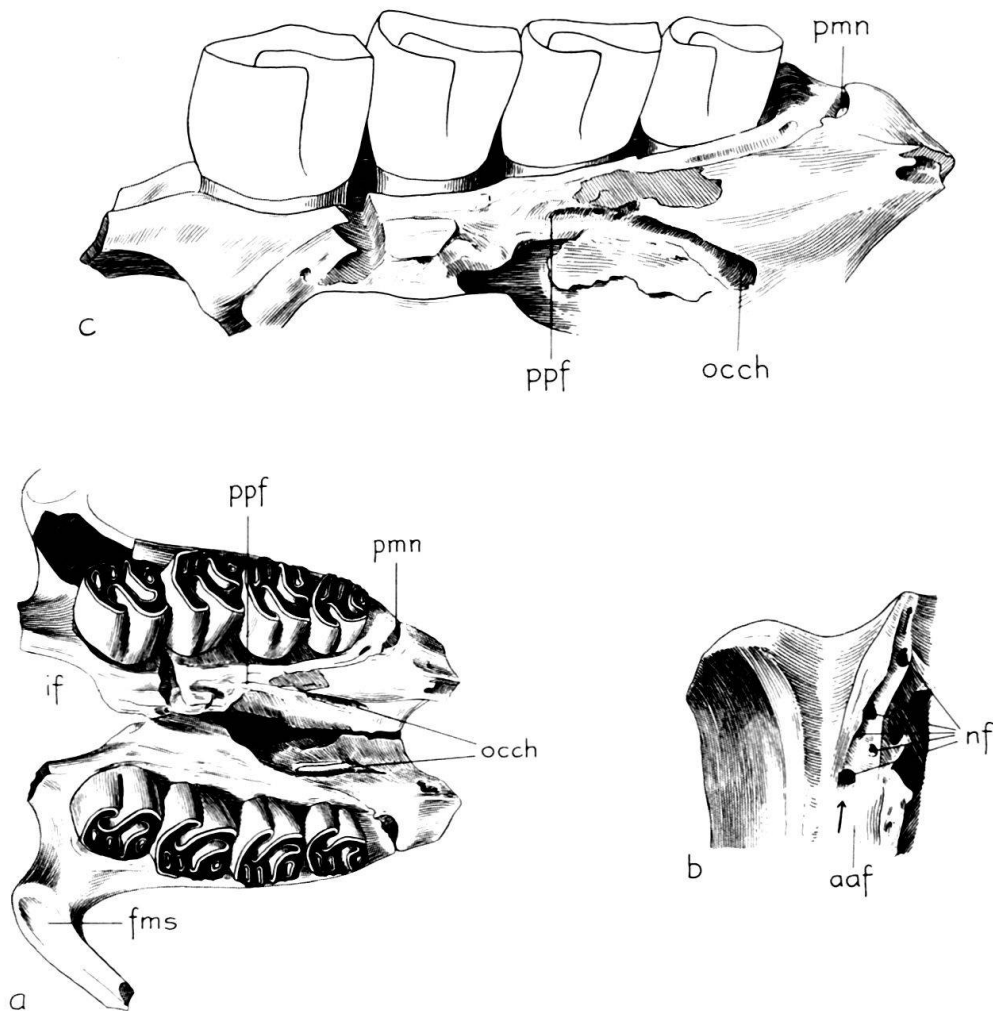

Fig. 24. *Toeniodus curvistriatus* POMEL 1854. BM(NH): M 27689. Palate with teeth row. a = ventral view. The right cheek teeth – somewhat fragmentary – is reconstructed on the basis of the left one. – $\times 4$. b = dorsal view with the canal of the anterior alveolar foramen opened, showing many nutritive foramina. – $\times 8,33$. c = lingual view of the left maxilla. – $\times 8,33$. St. Yvoine, France.

Lectotype. – MNHNP: THE-3 (fragment of mandible with P_4-M_3 dex. in SW-2)³). LAVOCAT (1952, p. 79) designated as Lectotype the specimen MHNL: Co-3 (P_4-M_3 dex.) and as Paralectotype the specimen MHNL: Co-2 (P^4-M^3); both with dubious reference to the Cournon locality. However, these specimens cannot belong to the syntype series applied by POMEL, 1854 and they did not come with any certainty from the type locality Sauvetat, France. For this reason, they cannot be designated the types (see THALER 1966, p. 74–75). Furthermore, *Echimys curvistriatus* LAIZER & PARIEU 1839 is a nomen nudum, because no description of LAIZER & PARIEU (1839, p. 206) was ever printed. For this reason it is not possible to take into account the type designation of PALMER (1904, p. 681). The specimens mentioned by THALER (1966, p. 74–75, Pl6, Fig. a, b, c) belong to the POMEL collection (and came from the Museum of Oran) and are the syntypes series. I select as Lectotype the specimen MNHNP: THE-3 (explained above) and as Paralectotypes the specimens MNHNP: THE-1 (a fragment of skull with P^4-M^3 dex. and D^4-M^2 sin.) and THE-2 (a fragment of mandible with P_4-M_2 sin.).

Topotypes. – Maxilla: BM(NH): 25543 (ex 27760 XII) P^4-M^2 f dex.; 27702 P^4-M^3 sin.; CCJR 201 P^4-M^3 sin. (labeled «Cournon» but by its lithology appears belong to Sauvetat). Mandibles: BM(NH): 25537 D_4-M_3 sin.; 25539 (ex 27760 VIII) P_4-M_3 dex.; 25541 (ex 27760 X) P_4-M_3 f dex.; 25548 M_1-M_3 dex.; 25553 (ex 27760d) P_4-M_3 sin.; 25554a P_4-M_3 sin.; 25554b P_4-M_2 sin.; 25554c D_4-M_3 dex.; 34900 M_1-M_3 sin. Isolated teeth: 25542 (ex 27760 XI) $M_1 + M_2$ sin. Measurements of P_4 , $M_{1/2}$ and M_3 of the specimens BM(NH): 25537; 25554a; 25554b; 25554c and 25548 together with the Lectotype and Paralectotype are offered in Table 41.

Type locality. – Sauvetat (France).

Other localities. – St. Yvoine and Cournon? (France); Grenchen-I (Switzerland).

Table 41: Measurements of the lower cheek teeth of *Toeniodus curvistriatus* POMEL, 1854 from La Sauvetat (France)

| Tooth | N | | range | \bar{X} | S | V |
|-----------|----|-----------------------|-----------|-----------|------|-------|
| P_4 | 4 | Sinusid height | 1,25–1,60 | 1,44 | 0,19 | 12,42 |
| | 4 | Length | 2,33–2,50 | 2,42 | 0,09 | 3,73 |
| | 4 | Width | 1,40–1,52 | 1,48 | 0,05 | 3,57 |
| | 2 | Sinusid length | 1,52–1,60 | 1,56 | 0,06 | 3,63 |
| | 2 | Extrasinusid distance | – | 0,00 | – | – |
| | 2 | Crown height | 1,67–2,00 | 1,84 | 0,23 | 12,72 |
| $M_{1/2}$ | 12 | Sinusid height | 0,92–1,60 | 1,20 | 0,23 | 19,15 |
| | 13 | Length | 1,84–2,17 | 2,03 | 0,09 | 4,37 |
| | 13 | Width | 1,67–1,83 | 1,72 | 0,08 | 4,90 |
| M_3 | 4 | Sinusid height | 0,92–1,42 | 1,17 | 0,24 | – |
| | 5 | Length | 1,67–1,83 | 1,74 | 0,06 | 3,33 |
| | 5 | Width | 1,08–1,67 | 1,40 | 0,24 | 17,15 |
| | 3 | Crown height | 1,25–1,67 | 1,39 | 0,24 | 17,45 |

³) When this paper was at the press I received two papers from M. Huguency (Lyon; 1986, Rev. scient. Bourbonnais and 1987: Ann. Paléont.), where she has designated as Lectotype of *T. curvistriatus* the same specimen: MNHNP: Lim 585 (ex THE-3). In addition Huguency has explained the correct spelling of *Toeniodus*.

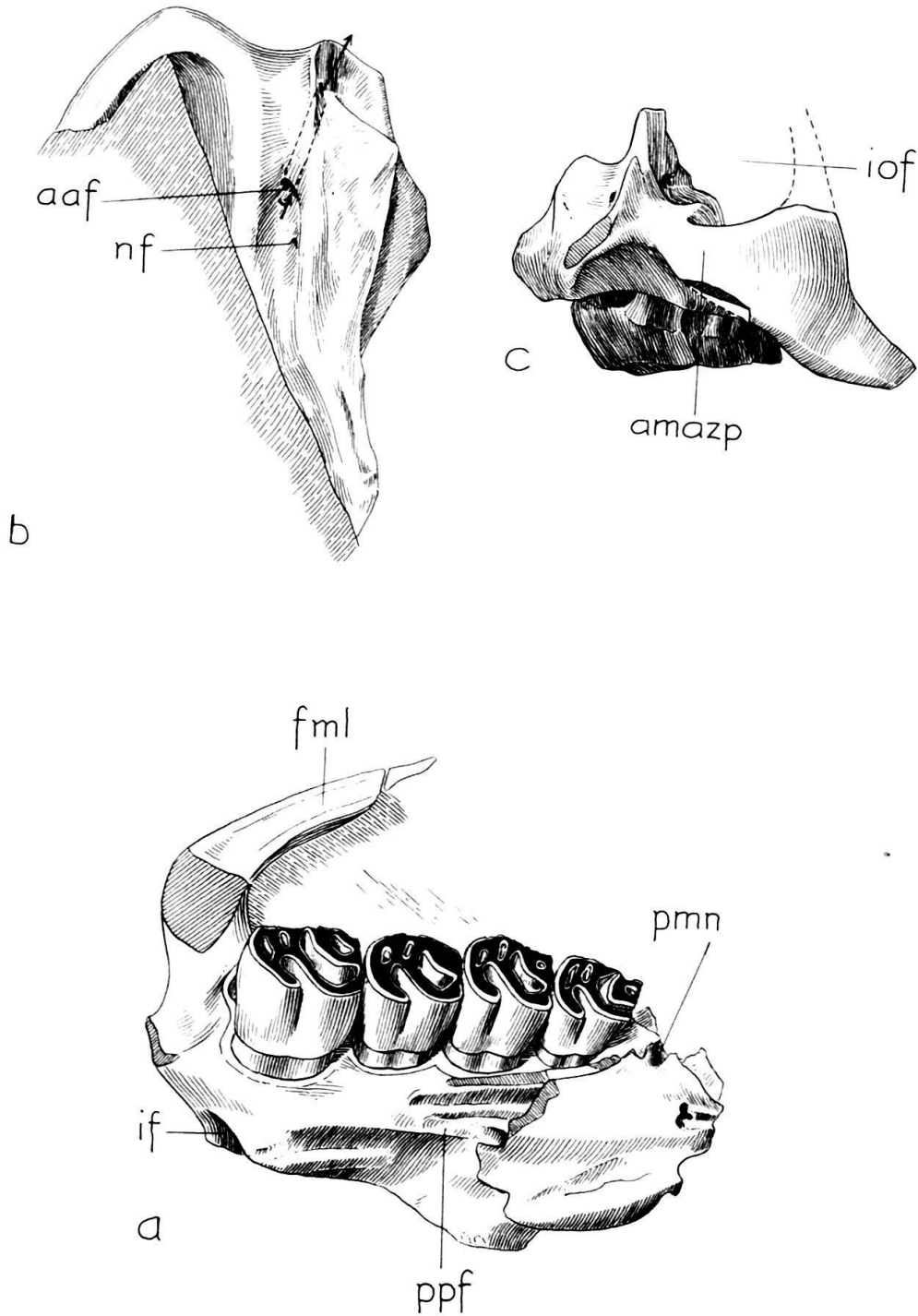

Fig. 25. *Toeniodus curvistriatus* POMEL 1854. BM (NH): M 27702. Left maxillary fragment with P⁴-M³. a = ventral-lingual view. b = dorsal view. c = frontal view. Sauvetat, France. - All figures × 6.

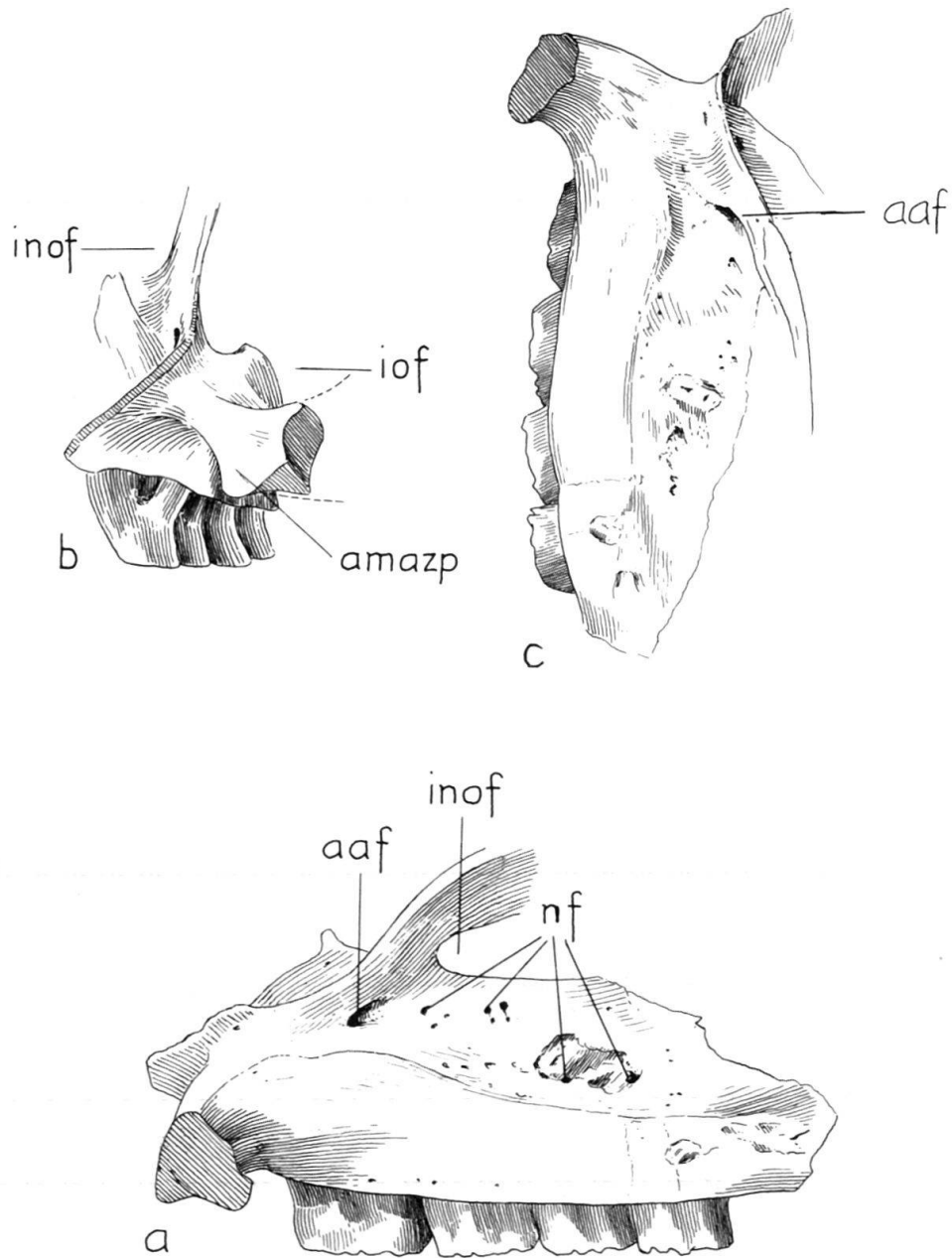

Fig. 26. *Toeniodus curvistriatus* POMEL 1854. BM(NH): CCJR 201. Left maxillary fragment with P⁴-M³. a = labial view. b = frontal view. c = dorsal view. Sauvetat, France. - All figures × 6.

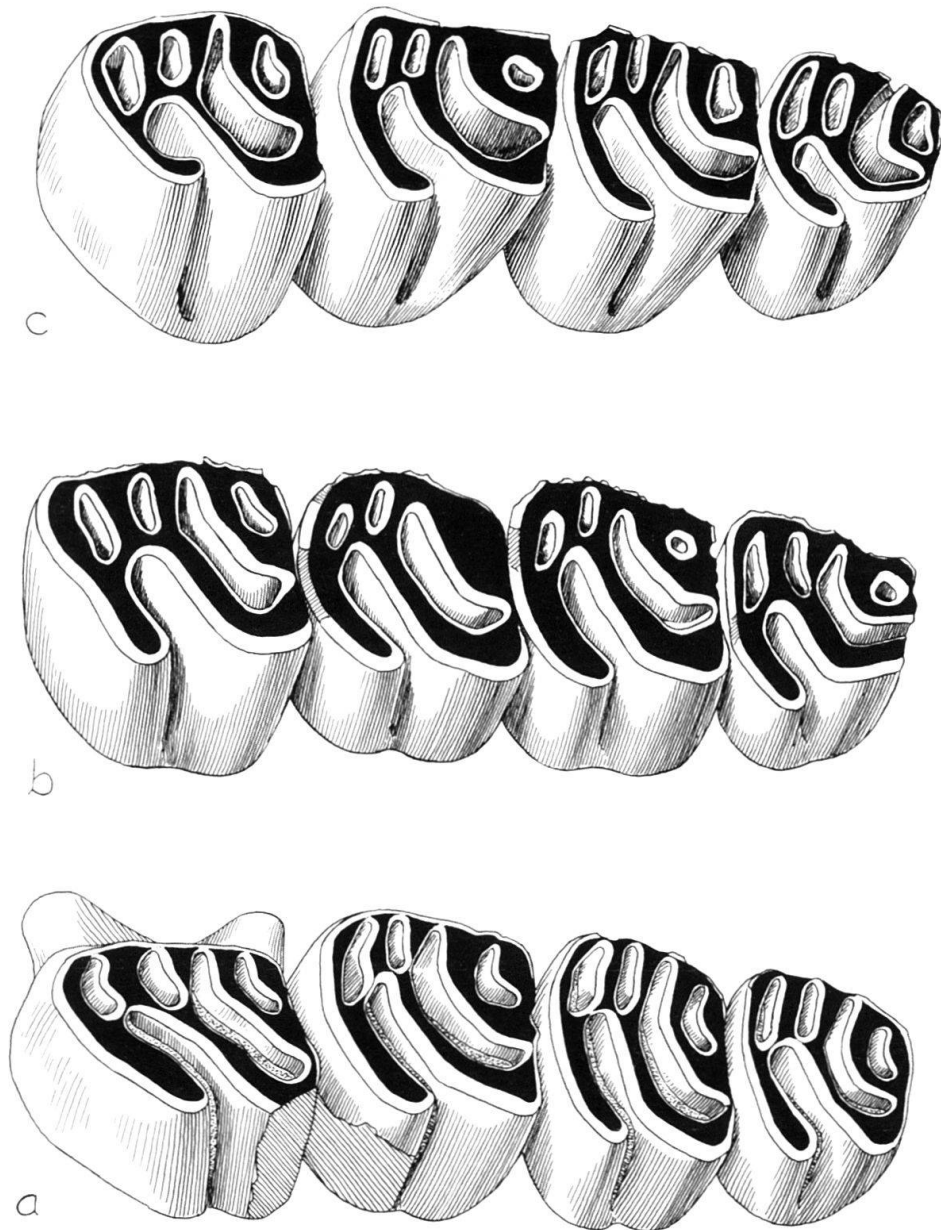

Fig. 27. *Toeniodus curvistriatus* POMEL 1854. a = BM(NH): CCJR 201. P⁴-M³ sin. Sauvetat, France. b = BM(NH): M 27702. P⁴-M³ sin. Sauvetat, France. c = BM(NH): M 27689. P⁴-M³ sin. St. Yvoine, France. – All figures $\times 12,5$.

Table 42: Measurements of the D⁴ and P⁴ of *Toeniodus ernii* n. sp. from Balm (Switzerland)

| Tooth | SW | N | | range | \bar{X} | S | V |
|----------------|----|---|---------------------|-----------|-----------|------|-------|
| D ⁴ | – | 1 | Sinus height | – | 0,83 | – | – |
| | | 1 | Length | – | 2,42 | – | – |
| | | 1 | Width | – | 1,25 | – | – |
| | | 1 | Crown height | – | 1,17 | – | – |
| P ⁴ | 1 | 1 | Sinus height | – | 2,08 | – | – |
| | | 1 | Length | – | 1,75 | – | – |
| | | 1 | Width | – | 1,50 | – | – |
| | | 1 | Sinus length | – | 0,67 | – | – |
| | | 1 | Extrasinus distance | – | 0,42 | – | – |
| | | 1 | Crown height | – | 2,58 | – | – |
| P ⁴ | 4 | 3 | Sinus height | 1,00–1,17 | 1,06 | 0,10 | 9,29 |
| | | 3 | Length | 1,92–2,00 | 1,95 | 0,05 | 2,37 |
| | | 3 | Width | 1,75–2,25 | 2,02 | 0,25 | 12,54 |
| | | 3 | Sinus length | 0,92–1,25 | 1,08 | 0,17 | 15,23 |
| | | 3 | Extrasinus distance | 0,50–0,58 | 0,55 | 0,05 | 8,35 |
| | | 3 | Crown height | 1,25–1,58 | 1,47 | 0,19 | 12,96 |

Stratigraphic range. – Oligocene, Lower “Chattien”, from Grenchen-I (faunal province of Switzerland and Savoy) to St. Yvoine (locality somewhat lower in age than Antoingt) of the West faunal province (see ENGESSER & MAYO 1987).

Geographical distribution. – Central and West Europe.

Table 43: Measurements of the M^{1/2} of *Toeniodus ernii* n. sp. from Balm (Switzerland)

| SW | N | | range | \bar{X} | S | V |
|----|---|---------------------|-----------|-----------|------|-------|
| 1 | 1 | Length | – | 1,50 | – | – |
| | 1 | Width | – | 1,00 | – | – |
| | 1 | Extrasinus distance | – | 0,42 | – | – |
| 3 | 4 | Sinus height | 1,58–1,83 | 1,73 | 0,11 | 6,10 |
| | 3 | Length | 1,67–1,92 | 1,78 | 0,13 | 7,17 |
| | 3 | Width | 1,42–1,67 | 1,59 | 0,14 | 9,10 |
| | 3 | Sinus length | 0,83–1,08 | 1,00 | 0,14 | 14,48 |
| | 3 | Extrasinus distance | 0,42–0,50 | 0,47 | 0,05 | 9,76 |
| | 4 | Crown height | 1,83–2,17 | 2,02 | 0,14 | 7,15 |
| 4 | 6 | Sinus height | 1,08–1,42 | 1,27 | 0,13 | 10,71 |
| | 6 | Length | 1,67–1,83 | 1,74 | 0,06 | 3,47 |
| | 5 | Width | 1,50–1,75 | 1,61 | 0,13 | 8,15 |
| | 6 | Sinus length | 0,92–1,33 | 1,08 | 0,16 | 15,23 |
| | 4 | Extrasinus distance | 0,33–0,50 | 0,44 | 0,08 | 18,51 |
| | 6 | Crown height | 1,42–1,92 | 1,63 | 0,17 | 10,67 |
| 5 | 2 | Sinus height | 0,75–0,83 | 0,79 | 0,06 | 7,16 |
| | 2 | Length | – | 1,67 | – | – |
| | 2 | Width | 1,75–1,92 | 1,84 | 0,12 | 6,55 |
| | 2 | Sinus length | 1,17–1,33 | 1,25 | 0,11 | 9,05 |
| | 2 | Extrasinus distance | 0,42–0,50 | 0,46 | 0,06 | 12,30 |
| | 2 | Crown height | 1,00–1,08 | 1,04 | 0,06 | 5,44 |

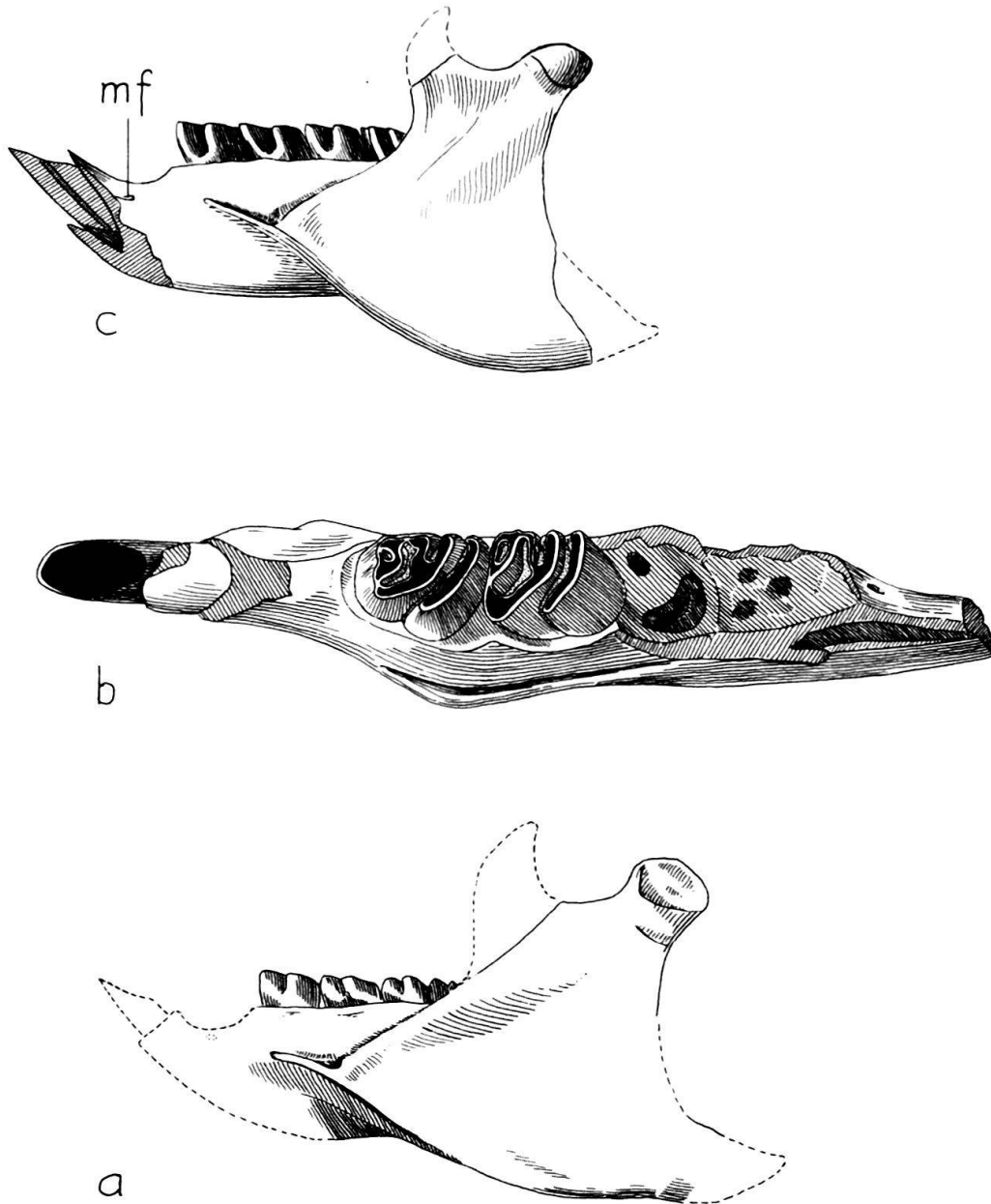

Fig. 28. *Toeniodus curvistriatus* POMEL 1854. a = MNHNP: THE-3. Right mandibular fragment with P₄-M₃ (invers.). Lectotype. Labial view. Sauvetat, France. - × 3. b = MNHNP: THE-4. Left mandibular fragment with P₄-M₁. Paralectotype. Dorsal view. Sauvetat, France. - × 6. c = BM(NH): M 25554a. Left mandibular fragment with P₄-M₃. Labial view. Sauvetat, France. - × 3.

Emended diagnosis. - Species of *Toeniodus* of large size with elevated crown height. Upper teeth pentaantyclines. With anterograben in D₄. Posterior border of the 4 anty-clinid deeply connected with the lingual border of the crown.

Measurement in the Table 41.

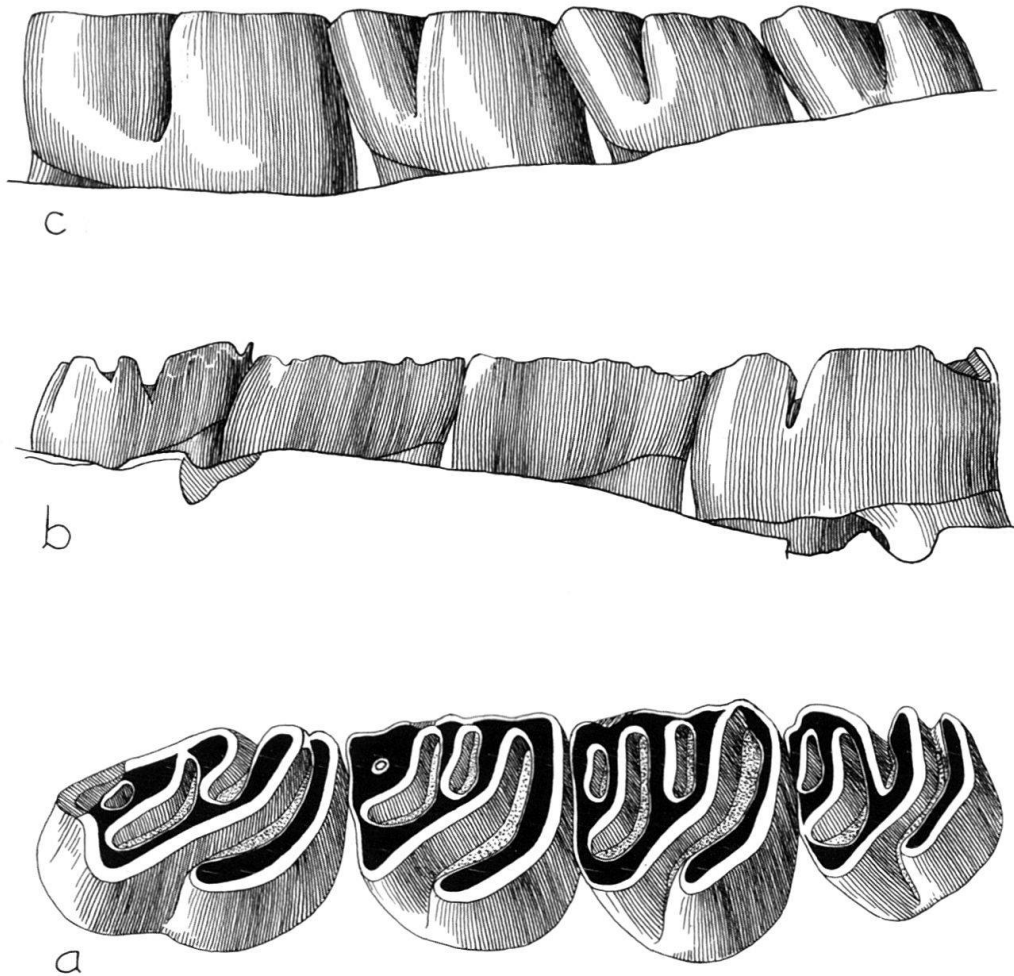

Fig. 29. *Taeniodus curvistriatus* POMEL 1854. a = MNHNP: THE-3. P₄-M₃. Lectotype. Occlusal view. b = lingual view. c = labial view. Sauvetat, France. – All figures × 12,5.

Toeniodus ernii n. sp.

Fig. 31

Synonymy. –

- 1941 *Pararchaeomys* n. sp. STEHLIN, 1941, p. 213, in: ERNI.
 1951 "*Pararchaeomys*" *curvistriatus* SCHAUB, 1951, p. 365, in: STEHLIN & SCHAUB.
 1951 *Taeniodus curvistriatus* SCHAUB, 1951, p. 79, 252, 365, 415 and 416, Fig. 106 and 107.
 1953 *Taeniodus curvistriatus* SCHAUB, p. 41, Fig. 22 and 23.
 1966 *Taeniodus curvistriatus* THALER, p. 74 and 75.
 1979 *Taeniodus curvistriatus* VIANEY-LIAUD, p. 227.

Derivatio nominis. – After the Swiss geologist Dr. A. Erni (1885–1945), collector of a part of the material described here.

Holotype. – NMB: Blm 43 (M_{1/2} sin) in SW-1, figured by STEHLIN & SCHAUB 1951, p. 252, Fig. 416.

Measurements of the Holotype. – Sinus height: 1,67. Length: 1,92, Width: 1,33; Crown height: 2,08.

Paratypes. – D⁴. – NMB: Blm 244. D₄. – NMB: Blm 243f and 246f. SW-1: P⁴. – NMB: Blm 61; M^{1/2}. – NMB: Blm 90f; M³. – NMB: Blm 55 and 223. NMO: Blm 136 and 141. P₄.

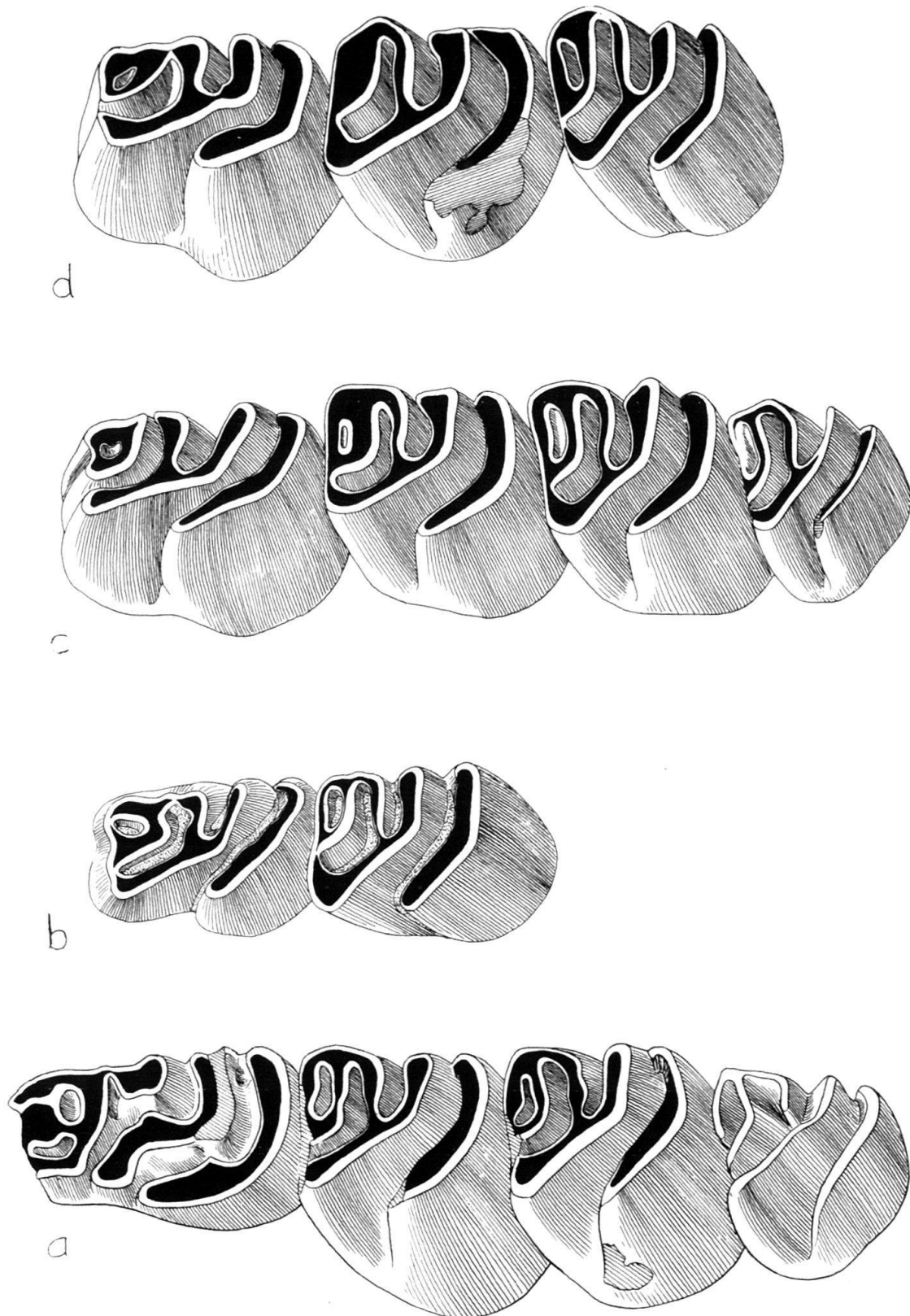

Fig. 30. *Toeniodus curvistriatus* POMEL 1854. a = BM(NH): M 25537. D₄-M₃ sin. b = MNHNP: THE-4. P₄-M₂ sin. Paralectotype. c = BM(NH): 25554a. P₄-M₃ sin. d = BM(NH): M 25554b. P₄-M₂ sin. Sauvetat, France. - All figures × 12,5.

Table 44: Measurements of the M^3 of *Toeniodus ernii* n. sp. from Balm (Switzerland)

| SW | N | | range | \bar{X} | S | V |
|----|---|---------------------|-----------|-----------|------|-------|
| 1 | 4 | Sinus height | 1,33–1,42 | 1,38 | 0,05 | 3,78 |
| | 3 | Length | 1,33–1,67 | 1,44 | 0,20 | 13,60 |
| | 4 | Width | 1,17–1,25 | 1,21 | 0,05 | 3,82 |
| | 2 | Sinus length | 0,76–0,83 | 0,80 | 0,05 | 6,23 |
| | 2 | Extrasinus distance | 0,48–0,50 | 0,49 | 0,02 | 2,89 |
| | 4 | Crown height | 1,83–1,92 | 1,88 | 0,05 | 2,77 |
| 2 | 3 | Sinus height | 1,25–1,50 | 1,36 | 0,13 | 9,39 |
| | 4 | Length | 1,25–1,50 | 1,40 | 0,10 | 7,54 |
| | 3 | Width | 1,17–1,33 | 1,28 | 0,09 | 7,24 |
| | 1 | Sinus length | – | 0,75 | – | – |
| | 1 | Extrasinus distance | – | 0,58 | – | – |
| | 3 | Crown height | 1,67–1,75 | 1,72 | 0,05 | 2,68 |
| 3 | 7 | Sinus height | 0,92–1,42 | 1,22 | 0,18 | 15,05 |
| | 7 | Length | 1,33–1,67 | 1,49 | 0,13 | 8,88 |
| | 7 | Width | 1,33–1,58 | 1,41 | 0,11 | 7,67 |
| | 7 | Sinus length | 0,80–1,00 | 0,90 | 0,08 | 9,14 |
| | 7 | Extrasinus distance | 0,50–0,67 | 0,54 | 0,06 | 12,05 |
| | 7 | Crown height | 1,33–1,83 | 1,56 | 0,18 | 11,91 |
| 4 | 2 | Sinus height | 0,92–1,00 | 0,96 | 0,06 | 5,89 |
| | 2 | Length | 1,33–1,67 | 1,50 | 0,24 | 16,03 |
| | 2 | Width | 1,25–1,42 | 1,34 | 0,12 | 9,00 |
| | 2 | Sinus length | 0,75–0,83 | 0,79 | 0,06 | 7,16 |
| | 2 | Extrasinus distance | 0,42–0,58 | 0,50 | 0,11 | – |
| | 2 | Crown height | 1,33–1,42 | 1,38 | 0,06 | 4,63 |
| 5 | 4 | Sinus height | 0,17–0,67 | 0,48 | 0,24 | – |
| | 4 | Length | 1,58–1,75 | 1,71 | 0,08 | 4,98 |
| | 4 | Width | 1,58–1,83 | 1,71 | 0,11 | 6,28 |
| | 4 | Sinus length | 1,00–1,42 | 1,27 | 0,18 | 14,56 |
| | 3 | Extrasinus distance | 0,50–0,60 | 0,56 | 0,05 | 9,45 |
| | 3 | Crown height | 0,67–0,92 | 0,80 | 0,13 | 15,70 |

– NMB: Blm 92. $M_{1/2}$. – NMB: Blm 45 and 47; NMO: Blm 66. M_3 . – NMB: Blm 39. SW-2: M^3 . – NMB: Blm 211, 225 and 234. NMO: Blm 146. $M_{1/2}$. – NMB: Blm 46, 214 and 218; NMO: Blm 168, 169, 171, 182 and 183. M_3 . – NMB: Blm 215. SW-3: P^4 . – NMB: Blm 222, 238 and 239. $M^{1/2}$. – NMB: Blm 60 and 85; NMO: Blm 138 and 139 (e). M^3 . – NMB: Blm 51, 56 and 62. NMO: Blm 135, 150 and 154. $M_{1/2}$. – NMB: Blm 81, 86 and 91. M_3 . – NMB: Blm 36, 67, 216 and 224. SW-4: $M^{1/2}$. – NMB: Blm 53, 54, 57, 227 and 236; NMO: Blm 147. M^3 . – NMB: Blm 59 and 226 (e); NMO: Blm 134. P_4 . – NMB: Blm 92 and 245. $M_{1/2}$. – NMB: Blm 35, 40, 42, 219 and 229. NMO: Blm 167, 172 and 177. M_3 . – NMB: Blm 212 and 213. SW-5: $M^{1/2}$. – NMO: Blm 155. NMB: Blm 231. M^3 . – NMO: Blm 137, 140, 156 and 157. NMB: Blm 38. $M_{1/2}$. – NMB: Blm 37 and 241. M_3 . – NMB: Blm 247.

Definition of the stage of wear. – Upper teeth: SW-1: unworn or almost unworn. SW-2: lightly worn. SW-3: III syncline open. SW-4: III syncline closed. SW-5: very worn stage. Extrasinus distance longer and Sinus height very reduced. Lower teeth: SW-1: unworn or almost unworn. SW-2: I synclinid open or closed, but others opened. SW-3: II synclinid closed, III synclinid open and graben present. SW-4: almost without graben or

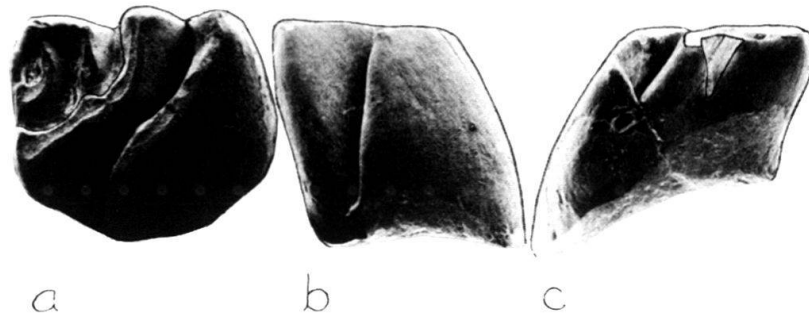

Fig. 31. *Toeniodus ernii* n. sp. NMB: BLM 43. $M_{1/2}$ sin. Holotype. a = occlusal view. b = labial view. c = lingual view. Balm, Switzerland. – All figures $\times 12,5$.

semigraben present, III synclinid closed or slightly open. SW-5: Semigraben with longer Extrasinusid distance and Sinusid height very reduced. (For P_4 SW-4 has place with II or III synclinids opened).

Type locality. – Balm, on the shores of the brook of Balm, canton of Solothurn, Switzerland (see ERNI 1941, Fig. 3 and KFSNMB).

Stratigraphic range. – Lower Oligocene, Rupelien, assemblage zone of Balm (see ENGESSER & MAYO 1987).

Geographical distribution. – Central Europe.

Diagnosis. – Pentaantycline species of *Toeniodus* of small size and low crown height. D_4 with antero-pseudograben or antero-graben. Graben of lower teeth present even in a very advanced stage of wear. Posterior border of 4 antyclinid without a deep connection with the lingual border of the crown. Sinusid height of $M_{1/2}$ in SW-1: 1,83–1,50. Semigraben emerging only in a very advanced stage of wear. Sinusid height of $M_{1/2}$ in SW-5: 0,16–0,12. Extrasinusid distance of $M_{1/2}$ in SW-5: 0,16–2,28.

Differential diagnoses. – *Toeniodus ernii* n. sp. differs from *T. curvistriatus* in the following characters:

- smaller size,
- lower crown height,

Table 45: Measurements of the P_4 of *Toeniodus ernii* n. sp. from Balm (Switzerland)

| SW | N | | range | \bar{X} | S | V |
|----|---|-----------------------|-----------|-----------|------|------|
| 4 | 2 | Sinusid height | 0,58–0,83 | 0,71 | 0,18 | – |
| | 2 | Length | – | 2,50 | – | – |
| | 2 | Width | 1,42–1,58 | 1,50 | 0,11 | 7,54 |
| | 2 | Sinusid length | – | 1,50 | – | – |
| | 2 | Extrasinusid distance | – | 0,17 | – | – |
| | 2 | Crown height | 0,92–1,25 | 1,09 | 0,23 | – |
| 5 | 1 | Sinusid height | – | 0,50 | – | – |
| | 1 | Length | – | 2,33 | – | – |
| | 1 | Width | – | 1,58 | – | – |
| | 1 | Sinusid length | – | 1,42 | – | – |
| | 1 | Extrasinusid distance | – | 0,50 | – | – |
| | 1 | Crown height | – | 0,92 | – | – |

- partial absence of anterogaben in the D₄,
- partial presence of anteropseudogaben in the D₄,
- shallow fusion of the posterior border of the 4 antyclinid with the lingual border of the crown,
- presence of the I synclinid in all stage of wear.

From *T. avus* STEHLIN & SCHAUB 1951 in the:

- slightly smaller size,
- presence of a graben in the lower teeth until a deeply worn stage,
- much longer sinusid length,
much shorter extrasinusid distance.

From *T. hexalophodus* BAHLO 1972 in the:

- smaller size,
- lower crown height,
- absence of hexaantycline morphotype,
- different morphology of the D⁴,
- partially different morphology of the D₄,
- absence of cement in the sinus, sinusid, syncline or synclinid.

Discussion. – STEHLIN (1941, p. 213, in: ERNI) considered the teeth of the new species here described, as a new genus and species: “*Pararchaeomys* n. sp.”. The real generic position of this material was showed by SCHAUB (1951, p. 79 and 252, Fig. 106, 107, 415

Table 46: Measurements of the M_{1/2} of *Toeniodus ernii* n. sp. from Balm (Switzerland)

| SW | N | | range | \bar{X} | S | V |
|----|---|-----------------------|-----------|-----------|------|-------|
| 1 | 4 | Sinusid height | 1,42–1,83 | 1,61 | 0,18 | 11,38 |
| | 4 | Length | 1,58–1,92 | 1,79 | 0,15 | 8,17 |
| | 4 | Width | 1,08–1,33 | 1,17 | 0,12 | 10,12 |
| | 4 | Crown height | 1,58–2,17 | 1,94 | 0,26 | 13,41 |
| 2 | 8 | Sinusid height | 1,00–1,67 | 1,23 | 0,25 | – |
| | 8 | Length | 1,75–2,08 | 1,87 | 0,11 | 6,01 |
| | 8 | Width | 1,33–1,75 | 1,54 | 0,13 | 8,25 |
| | 8 | Crown height | 1,33–2,00 | 1,57 | 0,30 | 18,97 |
| 3 | 3 | Sinusid height | 0,75–1,08 | 0,89 | 0,17 | 19,41 |
| | 3 | Length | 1,67–1,83 | 1,75 | 0,08 | 4,57 |
| | 3 | Width | 1,42–1,67 | 1,53 | 0,13 | 8,34 |
| | 3 | Crown height | 1,00–1,33 | 1,14 | 0,17 | 15,14 |
| 4 | 8 | Sinus height | 0,42–0,92 | 0,68 | 0,18 | – |
| | 8 | Length | 1,75–2,00 | 1,85 | 0,09 | 4,71 |
| | 8 | Width | 1,58–1,92 | 1,68 | 0,13 | 7,92 |
| | 8 | Crown height | 0,67–1,33 | 0,99 | 0,25 | – |
| 5 | 2 | Sinusid height | 0,12–0,16 | 0,14 | 0,03 | – |
| | 2 | Length | 1,83–1,92 | 1,88 | 0,06 | 3,39 |
| | 2 | Width | 1,67–1,83 | 1,75 | 0,11 | 6,46 |
| | 2 | Sinusid length | 1,33–1,58 | 1,46 | 0,18 | 12,15 |
| | 2 | Extrasinusid distance | 0,16–0,28 | 0,22 | 0,08 | – |
| | 2 | Crown height | 0,50–0,67 | 0,59 | 0,12 | – |

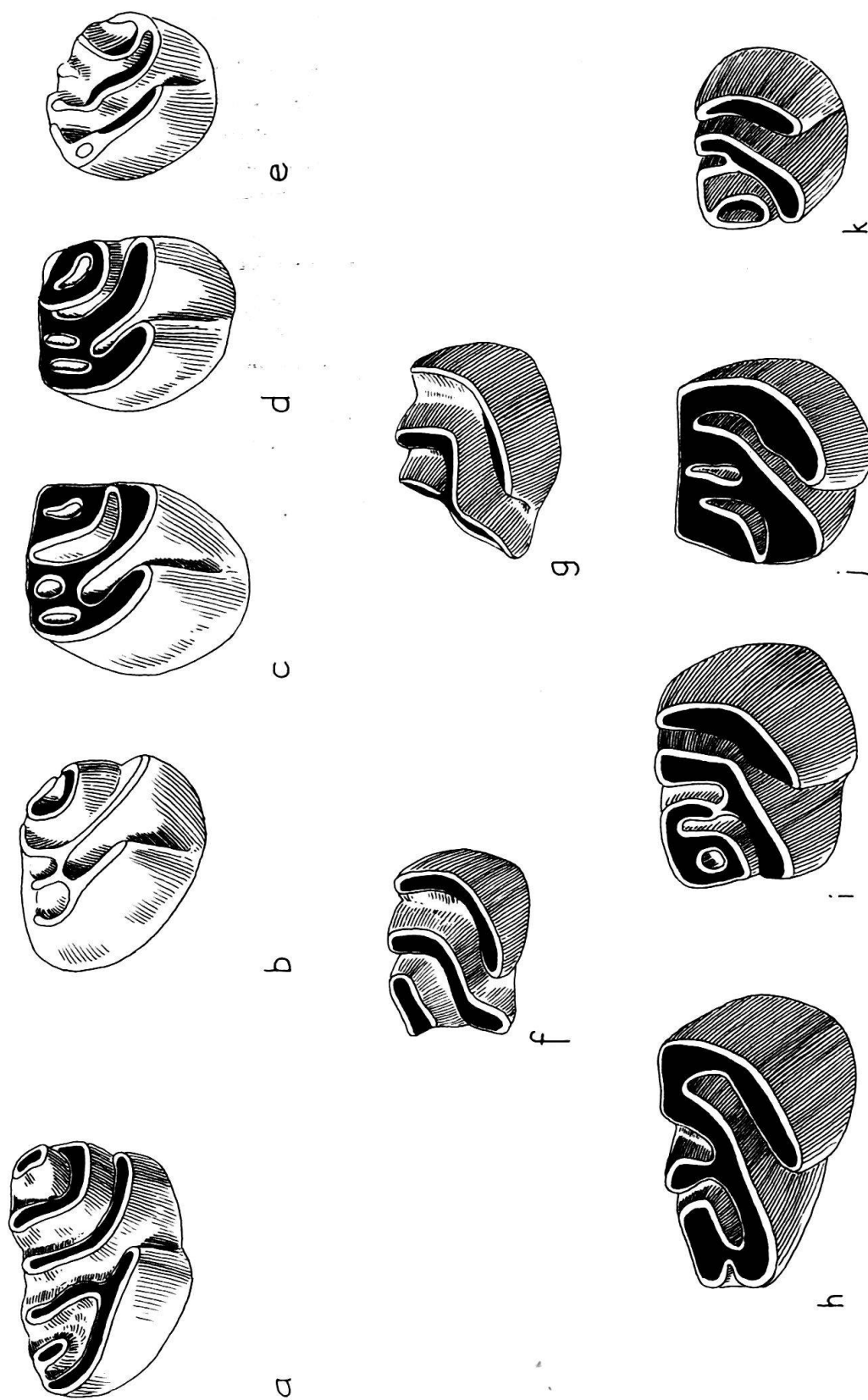

Fig. 32. *Toeniodus ernii* n. sp. a = NMB: Blm 244. D⁴ dex (invers.). b = NMB: Blm 61. P⁴ sin. c = NMB: Blm 53 dex (invers.). d = NMB: Blm 240. M² sin. e = NMB: Blm 141. M³ sin. f = NMB: Blm 243. D₄ dex (invers.). g = NMB: Blm 264. D₄ sin. h = NMB: Blm 245. P₄ sin. i = NMB: Blm 218. M₁ sin. j = NMB: Blm 40. M₂ dex (invers.). k = NMB: Blm 215. M₃ sin. Paratypes. Balm, Switzerland. — All figures × 12,5.

Table 47: Measurements of the M_3 of *Toeniodus ernii* n. sp. from Balm (Switzerland)

| SW | N | | range | \bar{X} | S | V |
|----|---|-----------------------|-----------|-----------|------|-------|
| 1 | 1 | Sinusid height | – | 0,83 | – | – |
| | 1 | Length | – | 1,50 | – | – |
| | 1 | Width | – | 1,08 | – | – |
| | 1 | Crown height | – | 1,25 | – | – |
| 2 | 1 | Sinusid height | – | 0,75 | – | – |
| | 1 | Length | – | 1,42 | – | – |
| | 1 | Width | – | 1,17 | – | – |
| | 1 | Crown height | – | 1,08 | – | – |
| 3 | 3 | Sinusid height | 0,50–1,00 | 0,77 | 0,23 | – |
| | 4 | Length | 1,34–1,68 | 1,55 | 0,16 | 10,41 |
| | 4 | Width | 1,25–1,44 | 1,34 | 0,08 | 5,84 |
| | 3 | Crown height | 0,92–1,25 | 1,12 | 0,18 | 15,83 |
| 4 | 1 | Sinusid height | – | 0,75 | – | – |
| | 2 | Length | 1,58–1,75 | 1,67 | 0,12 | 7,22 |
| | 2 | Width | 1,25–1,50 | 1,38 | 0,18 | 12,86 |
| | 1 | Crown height | – | 1,00 | – | – |
| 5 | 1 | Sinusid height | – | 0,58 | – | – |
| | 1 | Length | – | 1,58 | – | – |
| | 1 | Width | – | 1,50 | – | – |
| | 1 | Sinusid length | – | 1,00 | – | – |
| | 1 | Extrasinusid distance | – | 0,33 | – | – |
| | 1 | Crown height | – | 0,92 | – | – |

and 416, in: STEHLIN & SCHAUB) and by LAVOCAT (1952, p. 80). Nevertheless, the first author estimated in the afore mentioned work and also in his paper of 1953 (p. 41, Fig. 22 and 23) that the teeth from Balm belong to *Toeniodus curvistriatus* POMEL 1854. THALER (1966, p. 74–75) and VIANEY-LIAUD (1979, p. 227) were of the same opinion. However, comparison of the teeth of *T. curvistriatus* from Sauvetat (France) with those of *T. ernii* n. sp. from Balm show clearly, that the first species is more evolved than the second. *T. curvistriatus* is larger, slightly more semihypsodont, and the lamination of the 4 antyclinid is deeper in its fusion with the lingual border of the crown in the lower teeth, than those of *T. ernii* n. sp. In *T. curvistriatus* the anterior border of enamel of the graben is located in the upper portion of the crown, somewhat independent of the posterior enamel border. For instance, it remains open toward the lingual border, even when the very fine posterior enamel border is closed in a semigraben (Fig. 30). The Student t-test shows a high significance (1%) in the comparison of the length of all the $M_{1/2}$ from Balm (21 specimens) with all of the $M_{1/2}$ (recognized without doubt), that came from Sauvetat (13 specimens). The M^3 (NMB: Balm 141, Fig. 32e) is anomalous. It has a small hole in the first antycline, but it is not possible to take it as a real syncline. However, it could be the first stage of development of a syncline. In this case *T. ernii* n. sp. could be an ancestral species of *T. curvistriatus* and *T. hexalophodus*, something that is suggested by the two different morphotypes of the D_4 of *T. ernii* n. sp.

Measurements in the Tables 42–47.

Statistical test in the Tables 54 and 56.

Table 48: Measurements of the P⁴ of *Archaeomys (Archaeomys) kaelini* n. sp. from Fornant-6 (France)

| SW | N | | range | \bar{X} | S | V |
|----|---|---------------------|-----------|-----------|------|------|
| 2 | 1 | Sinus height | — | 3,75 | — | — |
| | 1 | Length | — | 2,58 | — | — |
| | 1 | Width | — | 1,92 | — | — |
| | 1 | Sinus length | — | 1,50 | — | — |
| | 1 | Extrasinus distance | — | 0,36 | — | — |
| | 1 | Crown height | — | 4,50 | — | — |
| 3 | 4 | Sinus height | 2,17–2,50 | 2,34 | 0,15 | 6,49 |
| | 2 | Length | 2,50–2,58 | 2,54 | 0,06 | 2,23 |
| | 3 | Width | 2,67–3,08 | 2,92 | 0,22 | 7,45 |
| | 3 | Sinus length | 2,17–2,25 | 2,20 | 0,05 | 2,10 |
| | 5 | Extrasinus distance | 0,08–0,33 | 0,24 | 0,12 | — |
| | 4 | Crown height | 2,83–3,17 | 3,00 | 0,15 | 5,11 |
| 4 | 5 | Sinus height | 1,17–2,83 | 1,88 | 0,60 | — |
| | 5 | Length | 2,33–2,75 | 2,52 | 0,15 | 5,97 |
| | 5 | Width | 2,33–2,83 | 2,68 | 0,21 | 7,74 |
| | 3 | Sinus length | 2,42–2,67 | 2,53 | 0,13 | 5,05 |
| | 3 | Extrasinus distance | 0,08–0,25 | 0,19 | 0,09 | — |
| | 4 | Crown height | 1,58–2,67 | 2,17 | 0,46 | — |
| 5 | 2 | Sinus height | 0,33–0,67 | 0,50 | 0,24 | — |
| | 2 | Length | 2,83–2,92 | 2,87 | 0,06 | 2,21 |
| | 4 | Width | 2,42–2,92 | 2,57 | 0,24 | 9,34 |
| | 0 | Sinus length | — | — | — | — |
| | 1 | Extrasinus distance | — | 0,12 | — | — |
| | 1 | Crown height | — | 1,33 | — | — |

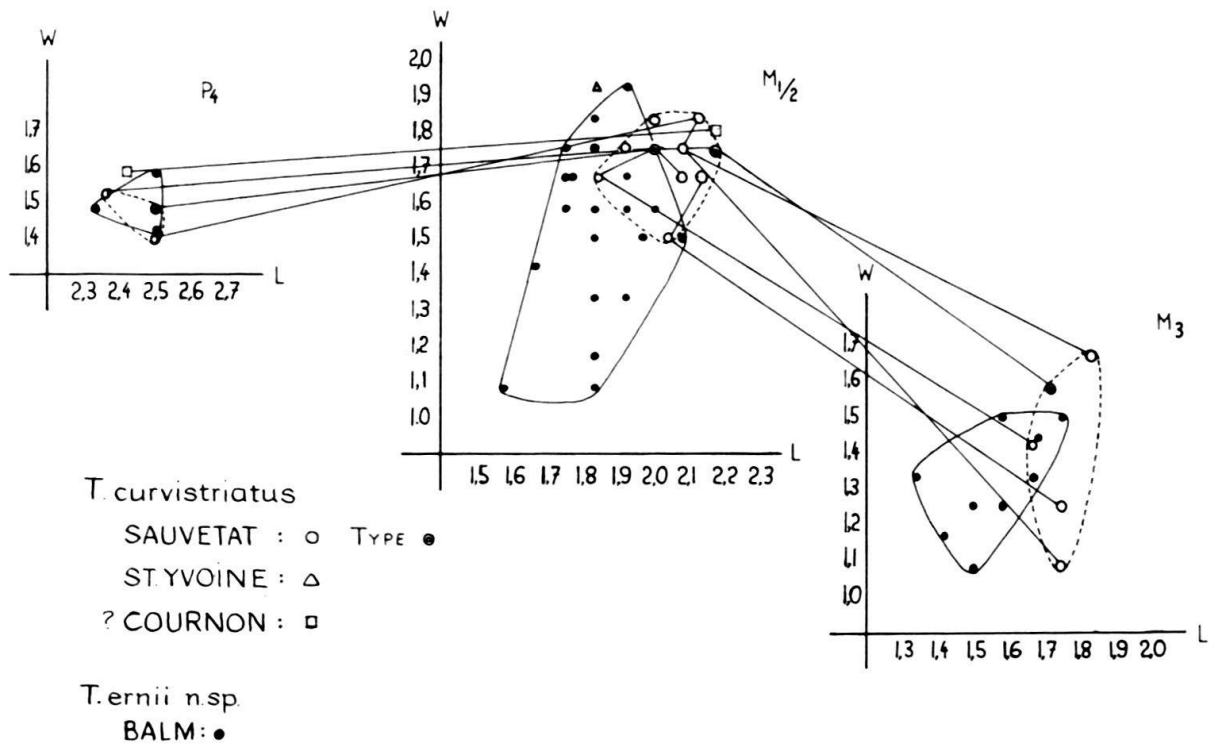

Fig. 33. Scatter diagrams of length against width in P₄, M₁, M₂ and M₃ of *Toeniodus curvistriatus* POMEL 1854 from Sauvetat (Type locality), St. Yvoine and ? Cournon, France and *Toeniodus ernii* n. sp. from Balm, Switzerland.

Genus *Archaeomys* LAIZER & PARIEU 1839Subgenus *Archaeomys* (*Archaeomys*) LAIZER & PARIEU 1839

Type species. – *Archaeomys* (*Archaeomys*) *laurillardi* BRAVARD, in: GERVAIS 1848–52.

Archaeomys (*Archaeomys*) *kaelini* n. sp.

Fig. 34–35

Synonymy. –

- 1984 *A.* (*Archaeomys*) aff. *helveticus* MAYO, p. 16, in: ENGESSER et al.
 1986 *A.* (*Archaeomys*) n. sp. MAYO, p. 5, in: ENGESSER et al.
 1987 *A.* (*Archaeomys*) n. sp. MAYO, p. 29.

Derivatio nominis. – After Mr. D. Kaelin (Balsthal), collector of the material of Breitenhöchi.

Holotype. – NMB: Sav 280 P⁴ in SW-3.

Measurements of the Holotype. – Sinus height: 3,75. Length: 2,58. Width: 1,92. Sinus length: 1,50. Extrasinus distance: 0,36. Crown height: 4,50.

Paratypes. – All in the collections of NMB. D⁴: Sav 281f. and 282f. D₄: Sav 283. P⁴: Sav 284–301. M^{1/2}: Sav 302–339. M³: Sav 340–354. P₄: 355–360. M_{1/2}: 361–390. M₃: 391–397.

Definition of the stage of wear. – To find some regularity in the teeth structure in the middle stage of wear SW-3 and 4 was a difficult matter for the upper teeth, especially in regards the sinus height. As a rule, most of the upper teeth in some advanced stage of wear show a semigraben very closed to the labial border. But with increased of wear, the lamellae of enamel can overtake the labial border of the crown. On the basis of this labile regularity the stages of wear are present in the following way: Upper teeth: SW-1 unworn or almost unworn stage with graben and all the synclines “opened”. SW-2: slightly worn. SW-3: semigraben is present. SW-4: “graben” is present. SW-5: very advanced worn stage;

Table 49: Measurements of the M^{1/2} of *Archaeomys* (*Archaeomys*) *kaelini* n. sp. from Fornant-6 (France)

| SW | N | | range | \bar{X} | S | V |
|----|----|---------------------|-----------|-----------|------|-------|
| 3 | 11 | Sinus height | 1,08–4,08 | 2,35 | 0,80 | – |
| | 10 | Length | 2,00–2,42 | 2,10 | 0,13 | 6,22 |
| | 12 | Width | 1,83–3,00 | 2,57 | 0,37 | 14,32 |
| | 8 | Sinus length | 1,83–2,83 | 2,23 | 0,38 | 16,92 |
| | 10 | Extrasinus distance | 0,02–0,17 | 0,09 | 0,05 | – |
| | 10 | Crown height | 1,75–4,08 | 2,93 | 0,64 | – |
| 4 | 5 | Sinus height | 0,83–2,92 | 1,97 | 0,86 | – |
| | 7 | Length | 2,08–2,50 | 2,27 | 0,17 | 7,62 |
| | 8 | Width | 2,08–3,00 | 2,54 | 0,38 | 14,92 |
| | 4 | Crown height | 1,08–2,75 | 1,98 | 0,75 | – |
| 5 | 7 | Sinus height | 0,08–1,83 | 0,94 | 0,68 | – |
| | 8 | Length | 2,00–2,42 | 2,17 | 0,14 | 6,66 |
| | 8 | Width | 2,50–3,08 | 2,74 | 0,21 | 7,68 |
| | 5 | Sinus length | 2,50–2,67 | 2,57 | 0,07 | 2,75 |
| | 7 | Extrasinus distance | 0,08–0,20 | 0,11 | 0,05 | – |
| | 8 | Crown height | 0,50–2,67 | 1,32 | 0,84 | – |

Table 50: Measurements of the M³ of *Archaeomys (Archaeomys) kaelini* n. sp. from Fornant-6 (France)

| SW | N | | range | \bar{X} | S | V |
|----|---|---------------------|-----------|-----------|------|-------|
| 2 | 1 | Sinus height | – | 3,58 | – | – |
| | 1 | Length | – | 1,92 | – | – |
| | 1 | Width | – | 1,83 | – | – |
| | 1 | Sinus length | – | 1,67 | – | – |
| | 1 | Extrasinus distance | – | 0,24 | – | – |
| | 1 | Crown height | – | 4,00 | – | – |
| 3 | 7 | Sinus height | 1,92–2,58 | 2,20 | 0,28 | 12,59 |
| | 6 | Length | 1,83–2,17 | 2,00 | 0,12 | 5,94 |
| | 7 | Width | 1,75–2,33 | 2,00 | 0,19 | 9,57 |
| | 3 | Sinus length | 1,75–2,33 | 2,02 | 0,29 | 14,35 |
| | 2 | Extrasinus distance | 0,04–0,16 | 0,10 | 0,08 | – |
| | 5 | Crown height | 2,17–2,67 | 2,47 | 0,19 | 7,72 |
| 4 | 4 | Sinus height | 0,58–1,75 | 1,21 | 0,52 | – |
| | 2 | Length | 2,33–2,42 | 2,38 | 0,06 | 2,68 |
| | 3 | Width | 2,25–2,58 | 2,39 | 0,17 | 7,21 |
| | 1 | Sinus length | – | 2,25 | – | – |
| | 1 | Extrasinus distance | – | 0,04 | – | – |
| | 4 | Crown height | 0,92–2,25 | 1,69 | 0,63 | – |

Table 51: Measurements of the P₄ of *Archaeomys (Archaeomys) kaelini* n. sp. from Fornant-6 (France)

| SW | N | | range | \bar{X} | S | V |
|----|---|----------------|-----------|-----------|------|-------|
| 2 | 2 | Sinusid height | 2,67–2,75 | 2,71 | 0,06 | 2,09 |
| | 2 | Length | 2,83–2,92 | 2,88 | 0,06 | 2,21 |
| | 2 | Width | 1,50–1,67 | 1,59 | 0,12 | 7,58 |
| | 2 | Crown height | 3,33–3,67 | 3,50 | 0,24 | 6,87 |
| 3 | 4 | Sinusid height | 2,00–2,42 | 2,19 | 0,22 | 10,04 |
| | 2 | Length | – | 3,58 | – | – |
| | 3 | Width | 1,67–2,08 | 1,89 | 0,21 | 10,93 |
| | 4 | Crown height | 2,92–3,33 | 3,06 | 0,18 | 5,95 |

Table 52: Measurements of the M_{1/2} of *Archaeomys (Archaeomys) kaelini* n. sp. from Fornant-6 (France)

| SW | N | | range | \bar{X} | S | V |
|----|----|----------------|-----------|-----------|------|-------|
| 2 | 1 | Sinusid height | – | 2,67 | – | – |
| | 1 | Length | – | 2,00 | – | – |
| | 1 | Width | – | 2,08 | – | – |
| | 1 | Crown height | – | 3,83 | – | – |
| 3 | 4 | Sinusid height | 1,67–2,25 | 1,88 | 0,26 | 13,78 |
| | 6 | Length | 2,00–2,50 | 2,17 | 0,17 | 8,10 |
| | 3 | Width | 2,08–2,42 | 2,22 | 0,18 | 7,92 |
| | 5 | Crown height | 2,17–2,92 | 2,57 | 0,28 | 11,09 |
| 4 | 12 | Sinusid height | 0,67–2,08 | 1,39 | 0,41 | – |
| | 10 | Length | 2,00–2,42 | 2,16 | 0,12 | 5,68 |
| | 9 | Width | 2,08–2,75 | 2,38 | 0,24 | 10,09 |
| | 10 | Crown height | 1,42–2,75 | 2,10 | 0,43 | – |
| 5 | 7 | Sinusid height | 0,33–1,67 | 0,81 | 0,53 | – |
| | 6 | Length | 2,00–2,67 | 2,20 | 0,25 | 11,50 |
| | 7 | Width | 2,33–2,75 | 2,58 | 0,20 | 7,59 |
| | 7 | Crown height | 0,58–2,08 | 1,52 | 0,59 | – |

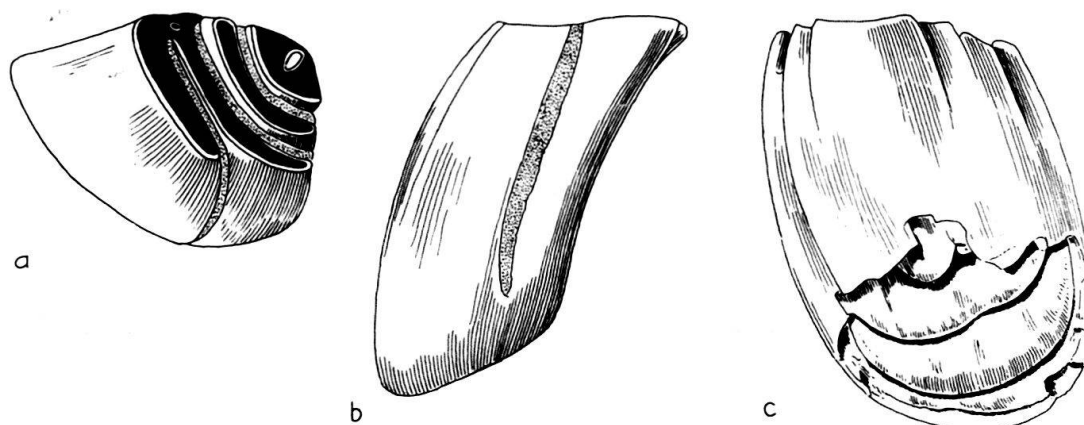

Fig. 34. *Archaeomys (Archaeomys) kaelini* n. sp. NMB: Sav 280. P⁴ sin. a = occlusal view. b = lingual view. c = posterior-labial view. See the filling laminae III and IV synclines. – All figures $\times 8,33$.

sinus height very reduced and semigraben is again present. Lower teeth: SW-1 and SW-2 as in the upper teeth. SW-3: graben is present. SW-4: semigraben is present. SW-5: sinusid height is very reduced. P⁴ with pseudograben or sinus.

Type locality. – Le Fornant river, Le Fornant, High Savoy, near to Frangy (France). See profile in WEIDMANN (1982, p. 18–21, Fig. 5 and 6, in: JUNG).

Other localities. – Breitenhöchi and Le Lendar (Switzerland), Chavanne (Savoy, France).

Stratum type. – Layer 6 of profile of Le Fornant river. See WEIDMANN (1982, p. 18–21, Fig. 5 and 6, in: JUNG).

Type formation. – Molasse rouge (Red Molasse).

Stratigraphic range. – Oligocene, Upper “Chattien”, assemblage zone of Fornant-6 (see ENGESSER & MAYO 1987).

Geographical distribution. – Central Europe.

Diagnosis. – Species of medium size and high semihypsodonty. Filling laminae to fully filling laminae syncline or synclinids in upper and lower teeth. Without semilaminae or

Table 53: Measurements of the M₃ of *Archaeomys (Archaeomys) kaelini* n. sp. from Fornant-6 (France)

| SW | N | | range | \bar{X} | S | V |
|----|---|-----------------------|-----------|-----------|------|-------|
| 3 | 2 | Sinusid height | 1,67–2,00 | 1,84 | 0,23 | 12,72 |
| | 3 | Length | 2,08–2,25 | 2,17 | 0,08 | 3,93 |
| | 3 | Width | 2,17–2,25 | 2,20 | 0,05 | 2,10 |
| | 2 | Crown height | 2,67–2,92 | 2,80 | 0,18 | 6,32 |
| 4 | 3 | Sinusid height | 1,00–1,67 | 1,28 | 0,34 | – |
| | 2 | Length | – | 2,08 | – | – |
| | 3 | Width | 2,00–2,25 | 2,14 | 0,13 | 5,97 |
| | 3 | Crown height | 1,42–2,17 | 1,78 | 0,38 | – |
| 5 | 1 | Sinusid height | – | 0,00 | – | – |
| | 1 | Length | – | 2,25 | – | – |
| | 1 | Width | – | 2,50 | – | – |
| | 1 | Sinusid length | – | 2,67 | – | – |
| | 1 | Extrasinusid distance | – | 0,04 | – | – |
| | 1 | Crown height | – | 0,50 | – | – |

Table 54: Values of the Pearson's coefficient of variation (V) for the length of the upper and lower teeth

| Tooth | N | Taxon | range | \bar{X} | S | V |
|------------------|----|---------------------------------------|-----------|-----------|------|-------|
| M ^{1/2} | 3 | <i>I. bumbachensis</i> n.sp. | 2,25–2,50 | 2,36 | 0,13 | 5,41 |
| M _{1/2} | 4 | <i>B. blainvillei</i> | 2,12–2,40 | 2,28 | 0,13 | 5,55 |
| M ₃ | 3 | <i>B. blainvillei</i> | 1,88–2,25 | 2,02 | 0,20 | 10,07 |
| P ⁴ | 6 | <i>B. stehlini</i> n.sp. | 2,25–2,83 | 2,44 | 0,22 | 9,05 |
| M ^{d/2} | 6 | <i>B. stehlini</i> n.sp. | 2,17–2,33 | 2,22 | 0,06 | 2,94 |
| M ³ | 5 | <i>B. stehlini</i> n.sp. | 1,92–2,33 | 2,15 | 0,18 | 8,31 |
| P ₄ | 7 | <i>B. stehlini</i> n.sp. | 2,50–3,25 | 2,95 | 0,33 | 11,05 |
| M _{1/2} | 9 | <i>B. stehlini</i> n.sp. | 2,17–2,58 | 2,31 | 0,13 | 5,56 |
| P ⁴ | 20 | <i>I. (S.) weidmanni</i> n.subg.n.sp. | 1,58–2,00 | 1,72 | 0,10 | 5,84 |
| M ^{1/2} | 24 | <i>I. (S.) weidmanni</i> n.subg.n.sp. | 1,58–2,08 | 1,84 | 0,12 | 6,37 |
| M ³ | 12 | <i>I. (S.) weidmanni</i> n.subg.n.sp. | 1,75–2,00 | 1,87 | 0,10 | 5,24 |
| P ₄ | 4 | <i>I. (S.) weidmanni</i> n.subg.n.sp. | 1,92–2,17 | 2,06 | 0,10 | 5,04 |
| M _{1/2} | 28 | <i>I. (S.) weidmanni</i> n.subg.n.sp. | 1,75–2,58 | 2,35 | 0,18 | 7,64 |
| M ₃ | 6 | <i>I. (S.) weidmanni</i> n.subg.n.sp. | 1,75–2,33 | 2,07 | 0,19 | 9,30 |
| P ⁴ | 9 | <i>I. (S.) oppligeri</i> n.sp. | 1,83–2,17 | 1,98 | 0,11 | 5,54 |
| M ^{1/2} | 15 | <i>I. (S.) oppligeri</i> n.sp. | 1,75–2,33 | 2,02 | 0,15 | 7,39 |
| M ³ | 12 | <i>I. (S.) oppligeri</i> n.sp. | 1,67–2,83 | 2,00 | 0,32 | 16,19 |
| P ₄ | 4 | <i>I. (S.) oppligeri</i> n.sp. | 2,00–2,33 | 2,13 | 0,16 | 7,46 |
| M _{1/2} | 21 | <i>I. (S.) oppligeri</i> n.sp. | 2,08–2,75 | 2,44 | 0,19 | 7,79 |
| M ₃ | 6 | <i>I. (S.) oppligeri</i> n.sp. | 2,17–2,42 | 2,29 | 0,10 | 4,49 |
| P ⁴ | 5 | <i>I. (S.) rickenbachensis</i> n.sp. | 1,50–1,83 | 1,68 | 0,14 | 8,12 |
| M ^{1/2} | 19 | <i>I. (S.) rickenbachensis</i> n.sp. | 1,83–2,33 | 2,01 | 0,13 | 6,46 |
| M ³ | 7 | <i>I. (S.) rickenbachensis</i> n.sp. | 1,83–2,17 | 1,99 | 0,10 | 5,16 |
| P ₄ | 5 | <i>I. (S.) rickenbachensis</i> n.sp. | 1,75–2,25 | 2,02 | 0,20 | 9,87 |
| M _{1/2} | 17 | <i>I. (S.) rickenbachensis</i> n.sp. | 2,17–2,75 | 2,36 | 0,15 | 6,32 |
| M ₃ | 4 | <i>I. (S.) rickenbachensis</i> n.sp. | 1,12–1,20 | 1,16 | 0,03 | 2,82 |
| D ⁴ | 3 | <i>N. balmensis</i> n.sp. | 1,50–1,60 | 1,53 | 0,06 | 3,77 |
| P ⁴ | 3 | <i>N. balmensis</i> n.sp. | 1,33–1,50 | 1,42 | 0,08 | 6,00 |
| M ^{1/2} | 24 | <i>N. balmensis</i> n.sp. | 1,33–1,58 | 1,45 | 0,07 | 5,18 |
| M ³ | 13 | <i>N. balmensis</i> n.sp. | 1,16–1,42 | 1,26 | 0,12 | 9,36 |
| P ₄ | 3 | <i>N. balmensis</i> n.sp. | 1,50–1,67 | 1,59 | 0,08 | 5,37 |
| M _{1/2} | 29 | <i>N. balmensis</i> n.sp. | 1,32–1,67 | 1,50 | 0,08 | 5,17 |
| M ₃ | 9 | <i>N. balmensis</i> n.sp. | 1,33–1,75 | 1,52 | 0,12 | 8,13 |
| P ⁴ | 3 | <i>O. ravellensis</i> n.gen.n.sp. | 1,75–1,92 | 1,83 | 0,08 | 4,64 |
| M ^{1/2} | 8 | <i>O. ravellensis</i> n.gen.n.sp. | 1,50–1,92 | 1,78 | 0,13 | 7,65 |
| P ₄ | 4 | <i>O. ravellensis</i> n.gen.n.sp. | 1,42–2,00 | 1,71 | 0,24 | 13,98 |
| M _{1/2} | 10 | <i>O. ravellensis</i> n.gen.n.sp. | 1,68–2,17 | 2,00 | 0,13 | 6,69 |
| M ^{1/2} | 7 | <i>O. huerzeleri</i> n.sp. | 2,25–2,50 | 2,37 | 0,09 | 4,03 |
| M _{1/2} | 10 | <i>O. huerzeleri</i> n.sp. | 2,33–2,75 | 2,52 | 0,15 | 5,85 |
| P ₄ | 4 | <i>T. curvistriatus</i> | 2,33–2,50 | 2,42 | 0,09 | 3,73 |
| M _{1/2} | 13 | <i>T. curvistriatus</i> | 1,84–2,17 | 2,03 | 0,09 | 4,37 |
| M ₃ | 5 | <i>T. curvistriatus</i> | 1,67–1,83 | 1,74 | 0,06 | 3,33 |
| P ⁴ | 4 | <i>T. ernii</i> n.sp. | 1,75–2,00 | 1,90 | 0,10 | 5,55 |
| M ^{1/2} | 12 | <i>T. ernii</i> n.sp. | 1,50–1,92 | 1,72 | 0,10 | 5,99 |
| M ³ | 20 | <i>T. ernii</i> n.sp. | 1,33–1,75 | 1,51 | 0,16 | 10,95 |
| P ₄ | 3 | <i>T. ernii</i> n.sp. | 2,33–2,50 | 2,44 | 0,10 | 4,02 |
| M _{1/2} | 25 | <i>T. ernii</i> n.sp. | 1,67–2,08 | 1,84 | 0,10 | 5,73 |
| M ₃ | 9 | <i>T. ernii</i> n.sp. | 1,34–1,75 | 1,56 | 0,13 | 8,45 |
| P ⁴ | 10 | <i>A. (A.) kaelini</i> n.sp. | 2,33–2,92 | 2,60 | 0,18 | 6,92 |
| M ^{1/2} | 25 | <i>A. (A.) kaelini</i> n.sp. | 2,00–2,50 | 2,17 | 0,16 | 7,31 |
| M ³ | 11 | <i>A. (A.) kaelini</i> n.sp. | 1,83–2,42 | 2,08 | 0,20 | 9,66 |
| P ₄ | 4 | <i>A. (A.) kaelini</i> n.sp. | 2,83–3,58 | 3,23 | 0,41 | 12,66 |
| M _{1/2} | 23 | <i>A. (A.) kaelini</i> n.sp. | 2,00–2,67 | 2,16 | 0,17 | 7,89 |
| M ₃ | 6 | <i>A. (A.) kaelini</i> n.sp. | 2,08–2,25 | 2,15 | 0,08 | 3,89 |

laminar syncline or synclinids in worn stage. D^4 with II syncline and without I. P^4 with pseudograben in SW-1 or SW-2 and long sinus and II syncline after SW-3. M^1-M^3 : with graben in SW-1 or SW-2 and semigraben after SW-3; pseudograben, sinus or II syncline absent. Enamel crest on crown surface very thin. Lamellae in lower teeth with angular disposition.

Differential diagnoses. – *A. (Archeomys) kaelini* n. sp. differs from *A. (Archeomys) intermedius* VIANEY-LIAUD 1977 in the following characters:

- robuster shape,
- higher semihypsodonty,
- absence of tubular and pseudolaminar synclines in M^1-M^3 ,
- longer synclines,
- longer semigraben,
- presence of filling to fully filling laminated synclines,
- absence of pseudograben in M^1-M^3 ,
- considerably thicker cellular cement in sinus and sinusid,
- different position of the posterior palatine foramen,
- presence of many foramina in palatine sulcus,
- D^4 without I syncline.

From *A. (Archeomys) helveticus* VIANEY-LIAUD 1977 in the:

- D^4 with II syncline,
- smaller size,

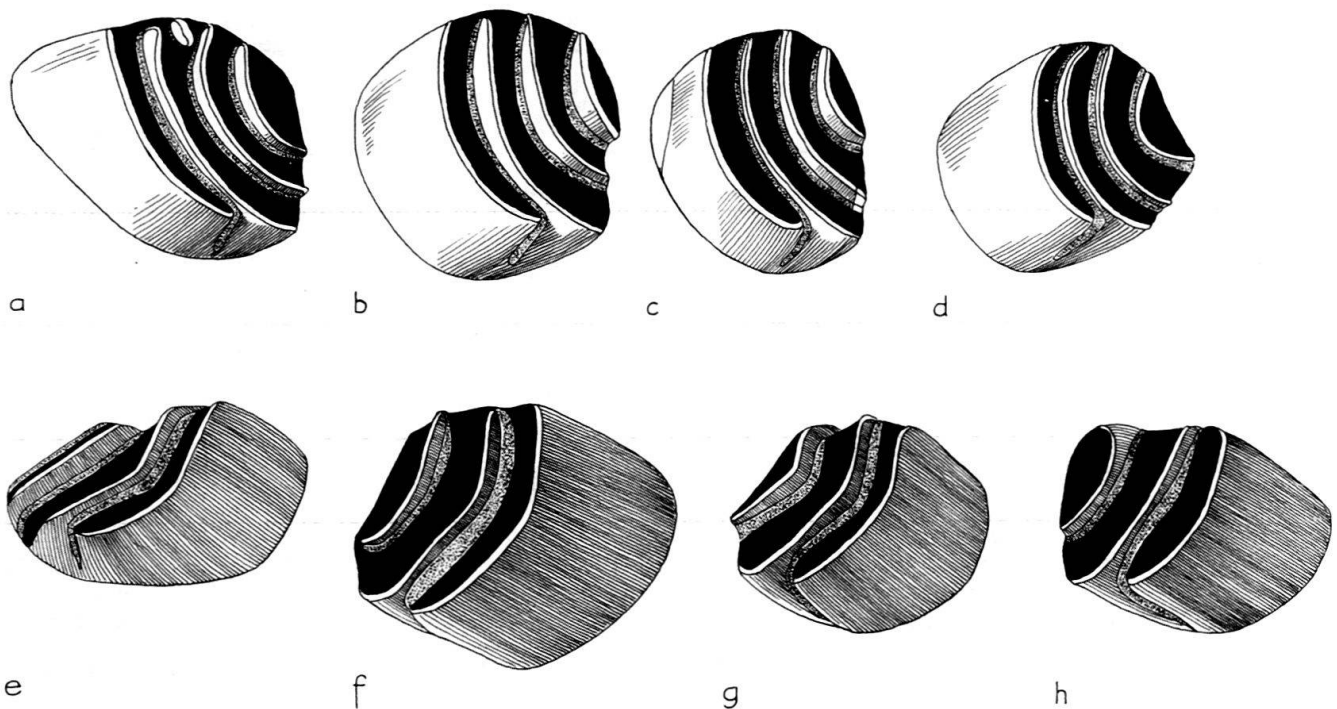

Fig. 35. *Archeomys (Archeomys) kaelini* n. sp. a = NMB: Sav 284. P^4 dex (invers.). b = NMB: SAV 302. M^1 dex (invers.). c = NMB Sav 303. M^2 sin. d = NMB: Sav 340. M^3 dex (invers.). e = NMB: Sav 355. P_4 sin. f = NMB: Sav 361. $M_{1/2}$ dex (invers.). g = NMB: Sav 362. $M_{1/2}$ dex (invers.). h = NMB: Sav 391. M_3 dex (invers.). Fornant-6, Savoy, France. – All figures $\times 8,33$.

DEVELOPMENT AND STRATIGRAPHICAL RANGE OF THE THERIDOMYIDAE
IN THE OLIGOCENE OF THE MOLASSE BASIN OF SWITZERLAND AND SAVOY

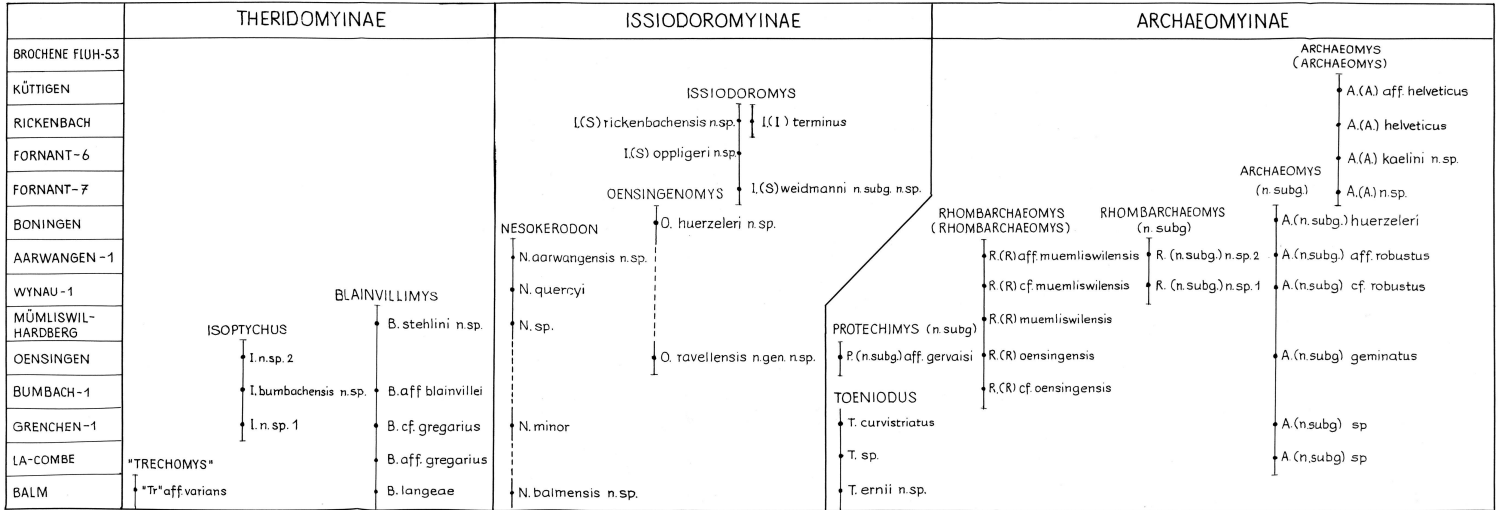

Table 56: Student-t Test for the length of upper and lower teeth

| Tooth | SW | N | X ₁ | Taxon ₁ | X ₂ | Taxon ₂ | Measurement | σ ² | s | t | 95% | 99% |
|------------------|-----------|----|----------------|---|----------------|---|----------------|----------------|------|------|-----|-----|
| M _{1/2} | * | 11 | 1,45 | <i>B. blainvillei</i> | 1,84 | <i>B. stehlini</i> | Sinusid length | 0,02 | 0,10 | 3,98 | + | + |
| M _{1/2} | * | 12 | 1,45 | <i>B. blainvillei</i> | 1,16 | <i>B. stehlini</i> | Ratio W/sd.l | 0,004 | 0,04 | 7,79 | + | + |
| P ⁴ | 3 + 4 + 5 | 19 | 1,72 | <i>I. (S.) weidmanni</i> (R. du Bey) | 1,67 | <i>I. (S.) weidmanni</i> (Fornant-7) | Length | 0,005 | 0,04 | 1,23 | - | - |
| P ⁴ | 3 + 4 | 15 | 1,74 | <i>I. (S.) weidmanni</i> | 2,06 | <i>I. (S.) oppligeri</i> | Length | 0,004 | 0,04 | 8,68 | + | + |
| M _{1/2} | 3 + 4 + 5 | 35 | 1,75 | <i>I. (S.) weidmanni</i> | 2,05 | <i>I. (S.) oppligeri</i> | Length | 0,112 | 0,12 | 2,59 | + | + |
| M _{1/2} | 4 + 5 | 43 | 2,36 | <i>I. (S.) weidmanni</i> | 2,44 | <i>I. (S.) oppligeri</i> | Length | 0,027 | 0,05 | 1,60 | - | - |
| M _{1/2} | 3 + 4 + 5 | 31 | 2,05 | <i>I. (S.) oppligeri</i> | 2,00 | <i>I. (S.) rickenbachensis</i> | Length | 0,019 | 0,05 | 1,10 | - | - |
| M _{1/2} | 4 + 5 | 38 | 2,43 | <i>I. (S.) oppligeri</i> | 2,34 | <i>I. (S.) rickenbachensis</i> | Length | 0,033 | 0,06 | 1,58 | - | - |
| M _{1/2} | * | 29 | 1,49 | <i>N. balmensis</i> | 1,75 | <i>N. medius</i> | Length | 0,004 | 0,04 | 5,89 | + | + |
| M _{1/2} | * | 34 | 1,99 | <i>T. curvistriatus</i> | 1,86 | <i>T. ernii</i> | Length | 0,006 | 0,03 | 4,27 | + | + |

* All the available SW

- lower semihypsodonty,
- constant presence of II syncline in the worn P⁴,
- presence of filling laminar synclines or synclinids,
- shorter synclines or synclinids,
- thinner cellular cement in the sinus and sinusid,
- thinner antyclines or antyclinids.
- thinner enamel crest on upper or lower teeth.

Discussion. – MAYO (1984, p. 16, in: ENGESSER et al.) indicated *A. (Archaeomys) kaelini* n. sp. from Fornant-6 as different to *A. (Archaeomys) helveticus* VIANEY-LIAUD 1977. MAYO (1986, p. 5, in: ENGESSER et al.) identified with some doubt the poor material from Talent-6 as *Archaeomys (Archaeomys)* n. sp. from Fornant-6. It could be expected that some morphotypes with pseudograben in unworn or slightly worn teeth, are placed together with morphotypes with graben instead pseudograben, as in the case of the fissure filling of Pech Desse and Pech du Fraysse (Quercy). But in the 52 upper molars from Fornant-6 there are none with pseudograben or a II syncline. That means that of the population 100% have graben or semigraben and the II syncline is completely absent. On the strength of these characters, *A. (Archaeomys) kaelini* n. sp. is a distinguishably different species to *A. (Archaeomys) intermedius*. On the other hand, of the 18 P⁴ there are none represented without a II syncline (see MAYO 1987, p. 29). This character, the smaller size, lower crown height, etc. permits the separation of *A. (Archaeomys) kaelini* n. sp. from *A. (A.) helveticus*. The examination of the IV syncline is especially recommended in all comparison (see MAYO 1987, p. 27–28, Fig. 3). The characters of the maxilla were observed in the specimen from Breitenhöchi.

Measurements in the Tables 48–53.

Statistical test in the Tables 54 and 56.

Acknowledgments

This work was supported by the Swiss National Science Foundation (projects No 2.099–0.78 and 2.887–0.83) and by the Max Geldner Stiftung. Dr. J. P. Berger, H. Bucher, Dr. B. Engesser, D. Kälin, D. Oppliger, Dr. D. Rigassi, M. Weick and Dr. M. Weidmann collected some part of the material described in this paper. U. Oberli and D. Oppliger prepared, in part, the fossil material. I am also indebted to the following institutions and persons for access to collections or lent me fossil material: Prof. Dr. V. Fahlbusch, (BSM); Dr. J. Hooker, BM(NH); Dr. M. Hugueney, FSL; J. Gad, IGJGUM; Dr. L. Ginsburg, MNHNP; Dr. A. Pfister, (NMBer); Prof. Dr. N. Schmidt-Kittler, IGJGUM; Dr. M. Vianey-Liaud, LPVUM and Dr. M. Weidmann, MGL. D. Kälin (Balsthal) made a generous donation to NMB of his private collection of which some part is described in this paper. Dr. Matter, Dr. D. Rigassi and Dr. M. Weidmann provided me with information about the Swiss Molasse. Dr. J. P. Berger gave me dating of charophyt material. I profited from the stimulating discussions and exchanges of information with Dr. B. Engesser during the elaboration of our work. Dr. R. Guggenheim and his collaborator M. Düggelein made the stereoscan photos. O. Garraux prepared the drawings. P. Schwarz and J. Zimmermann helped me in the picking of the washed materials. The manuscript was read in part by Prof. S. O. Landry Jr. and completely by A. Eaton, Dr. and Mrs. T. Harrison. All these people I would like to thank. To my wife Lic. Zs. Vályi-Nagy I am also owe my thanks for typing the manuscript and helping me to prepare it for the press.

BIBLIOGRAPHY

- ALSTON, E. R. (1876): On the classification of the order Glires. – Proc. zool. Soc. Lond. 1876, 61–98.
- BAHLO, E. (1972): *Taeniodus hexalophodus* and *Paracricetodon walgeri*, zwei neue Nagerspezies (Rodentia, Mammalia) aus dem Oligozän von Heimersheim bei Alzey (Rheinhausen, Westdeutschland). – Mainzer geowiss. Mitt. 1, 17–23.
- (1975): Die Nagetierfauna von Heimersheim bei Alzey (Rheinhausen, Westdeutschland) aus dem Grenzbe-
reich Mittel-/Oberoligozän und ihre stratigraphische Stellung. – Abh. hess. Landesamt Bodenforsch. 71,
1–182.
- BAUMBERGER, E. (1923): Das Bohnerz im Juragebirge. In: Eisen- und Manganerze der Schweiz. – Beitr. Geol.
Schweiz, geotech. Ser. (13)1, 3–125.
- (1927): Die stampischen Bildungen der Nordschweiz und ihrer Nachbargebiete mit besonderer Berücksichti-
gung der Molluskenfaunen. – Eclogae geol. Helv. 20/4, 533–578.
- BLAINVILLE, M. (1840): Rapport sur plusieurs Mémoires de Paleontologie. – C. R. Acad. Sci. (Paris) 10, 925–932.
- BONIS, L. DE (1964): Etude de quelques Mammifères du Ludien de la Débruge (Vaucluse). – Ann. Paléont. 50/2,
1–36.
- BOSMA, A. A. (1974): Rodent Biostratigraphy of the Eocene-Oligocene transitional strata of the Isle of Wight. –
Spec. Publ. Utrecht micropaleont. Bull. 1, 1–126.
- BOSMA, A. A., & INSOLE A. N. (1972): Theridomyinae (Rodentia, Mammalia) from the Osborne Beds (Late
Eocene), Isle of Wight, England. – Koninkl. Nederl. Akad. Wet. (B), 75/2, 131–144.
- BRUNET, M., HUGUENEY, M., & JEHENNE, Y. (1981): Cournon-Les Soumèroux: Un nouveau site à vertébrés
d'Auvergne; sa place parmi les faunes de l'Oligocène supérieur d'Europe. – Géobios 14/3, 323–359.
- DECHAUSEUX, C. (1963): Étude sur les rongeurs Adelomys, Oltinomys et Trechomys. – Ann. Paléont. 49, 221–260.
- ENGESSER, B., HÜRZELER, J. & MAYO, N. A. (1986): Die Säugetiere des Talent-Profiles. Provisorische Faunen-Listen
und Altersbestimmungen. – Schweiz. paläont. Ges. Exk. vom 27. April 1986, 1–7.
- ENGESSER, B., & MAYO, N. A. (1987): A biozonation of the Lower Freshwater Molasse (Oligocene and Agenian) of
Switzerland and Savoy on the basis of fossil mammals. – Münchener geowiss. Abh. [in press.].
- ENGESSER, B., MAYO, N. A., & WEIDMANN, M. (1984): Nouveaus gisements de mammifères dans la Molasse
subalpine vaudoise et fribourgeoise. – Mém. suisses Paléont. 107, 1–39.
- ERNI, A. (1941): Ein Tertiäraufschluss am Südfuss der Balmfluh bei Solothurn. Eclogae geol. Helv. 34, 209–219.
- FILHOL, H. (1877): Recherches sur les Phosphorites du Quercy. Etude des Fossiles qu'on y rencontre et spe-
cialement des mammifères. – Ann. Soc. géol. France (Paris) 8/1, 1–340.
- FISCHER-OOSTER, C. V. (1861): Übersicht aller bisher bekannten Fundorte fossiler Pflanzen aus der Molasseperiode
im Canton Bern. – Bern. Mitt. 369, 73–79.
- FREUDENBERG, H. (1941): Die Oberoligozänen Nager von Gaimersheim bei Ingolstadt und ihre Verwandten. –
Paleontographica (A) 42 1–164.
- FREUDENTHAL, M., & CUENA-BESCOS, G. (1984): Size variation of fossil rodent populations. – Scr. geol. 76, 1–28.
- GERVAIS, P. (1848–52): Zoologie et Paléontologie françaises (animaux vertébrés). – Arthus Bertrand, Paris.
- (1859): Zoologie et Paléontologie françaises (animaux vertébrés). – 2 ed. Arthus Bertrand, Paris.
- GIEBEL, C. G. (1855): Odontographie. Vergleichende Darstellung des Zahnsystems der Lebenden und Fossilen
Wirbelthiere. – Ambrosius Abel, Leipzig.
- GINGERICH, P. D. (1974): Size variability of the teeth in living mammals and the diagnosis of closely related
sympatric fossil species. – J. Paleont. 48/5, 895–903.
- (1976): Paleontology and phylogeny: patterns of evolution at the species level in early Tertiary mammals. –
Amer. J. Sci., 276, 1–28.
- HABICHT, J. K. A. (1987): Internationales Stratigraphisches Lexikon. Europa, 7b Schweiz. Schweizerisches Mittel-
land (Molasse). – Schweiz. Geol. Kommission 1/7, 1–528.
- HARTENBERGER, J. L. (1971): La Systématique des Theridomyoidea (Rodentia). – C. R. Acad. Sci. (Paris) 273,
1917–1920.
- (1973): Etude systématique des Theridomyoidea (Rodentia) de l'Eocène supérieur. – Mém. Soc. géol. France
[n.s.] (57), 117, 1–74.
- HAUS, H. (1937): Geologie der Gegend von Schangnau im oberen Emmental (Kanton Bern), ein Beitrag zur
Stratigraphie und Tektonik der subalpinen Molasse und des Alpenrandes. – Beitr. geol. Karte Schweiz, [N. F.]
75, 1–93.
- HEIM, A., & HARTMANN, A. (1919): Untersuchungen über die petroführende Molasse der Schweiz. – Beitr. geol.
Schweiz, [6], 1–36.

- HOOKER, J. J. (1986): Mammals from the Bartonian (middle/late Eocene) of the Hampshire Basin, southern England. – *Bull. brit. mus. nat. Hist.* 39/4, 191–478.
- HUGUENEY, M. (1969): Les Rongeurs (Mammalia) de l'Oligocène supérieur de Coderet-Bransat (Allier). – *Doc. Lab. Géol. Fac. Sci. Lyon* 34, 1–227.
- (1980): La Faune de Mammifères de l'Oligocène moyen de Saint-Menoux (Allier) 1^{re} partie. Rongeurs (Mammalia, Rodentia). – *Rev. scient. Bourbonnais*, 57–72.
- INTERNATIONAL COMMISSION ON ZOOLOGICAL NOMENCLATURE (1985): International Code of Zoological Nomenclature. – 3rd, Univ. California Press. London, Berkeley and Los Angeles, 1–338.
- JORDI, H. A. (1955): Geologie der Umgebung von Yverdon (Jurafuss und mittelländische Molasse). – *Beiträge zur Geologischen Karte der Schweiz*, [N. F.], 99, I–XIII, 1–84.
- JOURDAN, M. (1837): Mémoire sur un rongeur fossile des calcaires d'eau douce du centre de la France, considéré comme un type générique nouveau, le genre *Theridomys*. – *C. R. V.*, 483–484.
- JUNG, P. (1982): Nouveaux résultats biostratigraphiques dans le bassin molassique, depuis le Vorarlberg jusqu'en Haute Savoie. – *Doc. Lab. Géol. Lyon H.S.* 7/11–24.
- KEHRER, L. (1922): Beiträge zur Kenntnis der Geologie von Olten-Aarburg und Umgebung. – *Mitt. Aarg. natf. Ges.* 16, 1–46.
- LAIZER, L. DE, & PARIEU, M. DE (1839): Addition à deux Mémoires précédemment présentés sur des rongeurs fossiles de l'Auvergne. – *C. R. Acad. Sci. (Paris)* 8, 206.
- LANDRY, S. O. Jr. (1957): The interrelationships of the New and Old World Hystricomorph Rodents. – *Univ. Calif. Publ. Zool.* 56/1, 1–118.
- LARTET, M. E. (1869): Sur le *Trechomys bonduelli* et sur deux autres rongeurs fossiles de l'Eocène. – *Ann. sci. nat. (Paris)* 12/5, 155–166.
- LAVOCAT, R. (1952): Révision de la faune de Mammifères oligocènes d'Auvergne et du Velay. – *Sci. et Avenir*, Paris.
- (1971): Essai sur les relations du maxillaire et du palatin dans la région orbito-temporale des Rongeurs. – *Abh. hess. Landesamt Bodenforsch.* 60, 117–120.
- (1974): What is an Hystricomorph? – *Symp. zool. Soc. Lond.* 34, 7–20.
- LYDEKKER, R. (1885): Catalogue on the Fossil Mammalia in the British Museum (Natural History). – Taylor & Francis, London.
- MARTIN, R. (1906): Die untere Süsswassermolasse in der Umgebung von Aarwangen. – *Eclogae geol. Helv.* 9, 77–117.
- MAYO, N. A. (1980): Die Archaeomyinae LAVOCAT, 1952 (Rodentia: Mammalia) von Oensingen und Mümliswil (Oberoligozän) im Zusammenhang mit der stratigraphischen Einstufung dieser beiden Fundstellen. – *Eclogae geol. Helv.* 73/3, 1095–1107.
- (1981): Das Problem der oberoligozänen Nagetierart *Archaeomys chinchilloides* GERVAIS 1848 (Mammalia). – *Eclogae geol. Helv.* 74/3, 1007–1926.
- (1982): Bemerkungen zur Systematik und Evolution einiger Theridomyidae und Cricetidae (Rodentia, Mammalia) des Oligozäns: Antwort an M. VIANEY-LIAUD. *Eclogae geol. Helv.* 75/3, 697–719.
- (1983): Neue Archaeomyinae LAVOCAT 1952 (Rodentia, Mammalia) der Schweizer Molasse. *Biostratigraphie und Evolution*. – *Eclogae geol. Helv.* 76/3, 827–910.
- (1987): La heterocronicidad de algunas faunas de mamíferos fósiles con Theridomyidae del Oligoceno, en las fisuras rellenas de las "Fosforitas del Quercy". – *Int. Symp. Mamm. Biostr. Paleocol. Europ. Paleogene. Mainz*, 1–34.
- (1987a): The Development of the Theridomyidae in the Oligocene of the Molasse of Switzerland and Savoy. – *Münchener Geowiss. Abh.* [in press.].
- (1987b): Neue Issiodoromyinae (Rodentia, Mammalia) der oligozänen Molasse der Schweiz und Savoyens. – [In preparation].
- MONES, A. (1968): Proposición de una nueva terminología relacionada con el crecimiento de los molares. – *Zool. Platense* 1/3, 13–14.
- (1982): An equivocal nomenclature: What means hypsodonty? – *Paläont. Z.*, 56(1/2), 107–111.
- PALMER, T. S. (1904): Index Generum Mammalium: a list of the genera and families of mammals. – *North American Fauna* 23, 1–984.
- PATTERSON, B., & WOOD, A. (1982): Rodents from the Deseadan Oligocene of Bolivia and the Relationships of the Caviomorpha. – *Bull. Mus. Comp. Z.* 149/7, 371–543.
- POMEL, M. (1954): Catalogue méthodique et descriptif des Vertébrés Fossiles. – *Ann. sci. litt. ind. Auvergne* 25, 337–380, and 26, 81–229.

- RUTSCH, R. F. & SCHLÜCHTER, CHR. (1973): Stratigraphische Gliederung der Molasse im bernischen Mittelland. – Mitt. natf. Ges. Bern [N. F.] 30, 86–90.
- SCHAUB, S. (1953): La Trigonodontie des Rongeurs Simplicidentés. – Ann. Paléont. 39, 29–57.
- (1958): Simplicidentata (= Rodentata) In: PIVETEAU, J. (Ed.): Traité de Paléontologie (p. 659–818). – Masson, Paris.
- SCHLOSSER, M. (1884): Die Nager des europäischen Tertiärs. – Paleontographica, 31, 1–143.
- SIMPSON, G. G., ROE, A., & LEWONTIN, R. C. (1960): Quantitative Zoology. – Harcourt, Brace & World, New York.
- STEHLIN, H. G. (1914): Übersicht über die Säugetiere der Schweizerischen Molassenformation, ihre Fundorte und ihre stratigraphische Verbreitung. – Verh. natf. Ges. Basel 25, 179–193.
- (1922): Säugetierpaläontologische Bemerkungen zur Gliederung der oligocänen Molasse. – Eclogae geol. Helv. 16/5, 575–581.
- STEHLIN, H. G. & SCHAUB, S. (1951): Die Trigonodontie der simplicidentaten Nager. – Schweiz. paläont. Abh. 67, 1–385.
- THALER, L. (1965): Une échelle de zones biochronologiques pour les Mammifères du Tertiaire d'Europe. – C. R. somm. Séance Soc. géol. France 4, 118.
- (1966): Les rongeurs fossiles du Bas-Languedoc dans leurs rapports avec l'histoire des faunes et la stratigraphie du Tertiaire d'Europe. – Mém. Mus. natl. Hist. nat. (Paris) (C), 17, 1–295.
- TOBIEN, H. (1972): Mikromammalier aus dem alttertiären Melaninton von Nordhessen. Teil 2: Rodentia, Biostratigraphie, Biostratonomie. – Notizbl. hess. Bodenforsch. 100, 7–40.
- (1974): Zur Gebissstruktur, Systematik und Evolution der Genera *Amphilagus* und *Titanomys* (Lagomorpha, Mammalia) aus einigen Vorkommen im jüngeren Tertiär Mittel- und Westeuropas. – Mainzer geowiss. Mitt. 3, 95–214.
- (1978): Brachyodonty and Hypsodonty in some Paleogene Eurasian Lagomorphs. – Mainzer geowiss. Mitt. 6, 161–175.
- TROUSSART, E. L. (1898–99): Catalogus Mammalium tam Viventium quam Fossilium. – Friedländer & Son, Berolini, 2t.
- VIANEY-LIAUD, M. (1972): Un cas de parallélisme intragenérique: l'évolution du genre *Theridomys* (Rodentia, Theridomyidae) à l'Oligocene moyen. – C. R. Acad. Sci. Paris, 274 (D), 1007–1010.
- (1973): L'évolution du genre *Theridomys* à l'Oligocène moyen. Intérêt biostratigraphique. – Bull. Mus. natl. Hist. nat. (Paris) (3) 98, 295–371.
- (1976): Les Issiodoromyinae (Rodentia, Theridomyidae) de l'Eocène Supérieur à l'Oligocène Supérieur en Europe occidentale. – Paleovertebrata 7/1–2, 1–115.
- (1977): Nouveaux Theridomyinae du Paléogène d'Europe occidentale. – C. R. Acad. Sci. Paris, 284, (D), 1277–1280.
- (1979): Evolution des rongeurs à l'Oligocène en Europe occidentale. – Paleontographica (A) 166/4–6, 135–236.
- (1980): La paléontologie du Quercy: les Phosphorites. – Quercy Recherche, Cahors 34, 24–42.
- (1982): Observations à la note de N. MAYO (1980) sur les Archaeomyinae de Oensingen et Mümliswil (Oligocene de la molasse suisse). – Eclogae geol. Helv. 75/3, 689–696.
- (1985): Nouvelle quantification de l'hypsodontie chez les Theridomyidae: l'exemple de *Theridomys ludensis* n. sp. – Paleovertebrata, 15/3, 159–172.
- VIANEY-LIAUD, M. & LEGENDRE, S. (1986): Les faunes des phosphorites du Quercy: Principes méthodologiques en paléontologie des mammifères fossiles. – Eclogae geol. Helv. 79/3, 917–944.
- VIRET, J. (1929): Les faunes de Mammifères de l'Oligocène supérieur de la Limagne bourbonnaise. – Ann. Univ. Lyon [n. s.] I: Sci., Méd. 47, 1–328.
- WAHLERT, J. H. (1974): The Cranial Foramina of Protrogomorphus Rodents; an Anatomical and Phylogenetic Study. – Bull. Mus. Comp. Z. 146/8: 363–410.
- (1977): Cranial Foramina and Relationships of *Eutypomys* (Rodentia, Eutypomyidae). – Amer. Mus. Nov. 2626, 1–8.
- (1978): Cranial Foramina and Relationships of the Eomyidea (Rodentia, Geomorpha). Skull and Upper Teeth of *Kansasimys*. – Amer. Mus. Nov. 2645, 1–16.
- WAIBEL, A. & BURRI, F. (1961): Juragebirge und Rheintalgraben. – Lex. stratig. int. Europe 1/7, 1–314.
- WINGE, H. (1941): The interrelationships of the Mammalian genera. – Kobenhavn, C. A. Reitzels, 2, 1–376.
- ZITTEL, K. A. (1891–93): Paleozoologie. – R. Oldenburg, München.

Manuscript received 29 June 1987

Revision accepted 2 August 1987

