

Planches 34-75

Objektyp: **Group**

Zeitschrift: **Cahiers d'archéologie romande**

Band (Jahr): **142 (2013)**

PDF erstellt am: **24.09.2024**

Nutzungsbedingungen

Die ETH-Bibliothek ist Anbieterin der digitalisierten Zeitschriften. Sie besitzt keine Urheberrechte an den Inhalten der Zeitschriften. Die Rechte liegen in der Regel bei den Herausgebern.

Die auf der Plattform e-periodica veröffentlichten Dokumente stehen für nicht-kommerzielle Zwecke in Lehre und Forschung sowie für die private Nutzung frei zur Verfügung. Einzelne Dateien oder Ausdrucke aus diesem Angebot können zusammen mit diesen Nutzungsbedingungen und den korrekten Herkunftsbezeichnungen weitergegeben werden.

Das Veröffentlichen von Bildern in Print- und Online-Publikationen ist nur mit vorheriger Genehmigung der Rechteinhaber erlaubt. Die systematische Speicherung von Teilen des elektronischen Angebots auf anderen Servern bedarf ebenfalls des schriftlichen Einverständnisses der Rechteinhaber.

Haftungsausschluss

Alle Angaben erfolgen ohne Gewähr für Vollständigkeit oder Richtigkeit. Es wird keine Haftung übernommen für Schäden durch die Verwendung von Informationen aus diesem Online-Angebot oder durch das Fehlen von Informationen. Dies gilt auch für Inhalte Dritter, die über dieses Angebot zugänglich sind.

Planches 34-75

Pl. 34: 621- K13871-2; 622- K13814-1; 623- K13826-6; 624- K13825-2; 625- K13871-3; 626- K13814-14.

Pl. 35: 627- K13821-3; 628- K13821-5; 629- K13814-42; 630- K13814-40; 631- K13814-35; 632- K13814-47; 633- K13814-36; 634- K13871-27; 635- K13814-38/R270; 636- K13814-37; 637- K13814-39; 638- K13871-14/R313; 639- K13821-1; 640- K13826-4; 641- K13871-72.

Pl. 36: 642- K13871-56; 643- K13890-22; 644- K13871-78; 645- K13825-8; 646- K13814-80; 647- K13814-34; 648- K13814-72; 649- K13814-31; 650- K13814-33.

Pl. 37: 651- K13871-50; 652- K13871-68; 653- K13871-10/R317; 654- K13814-25; 655- K13814-73; 656- K13826-8; 657- K13871-15; 658- K13814-79; 659- K13825-5; 660- K13890-3; 661- K13871-19; 662- K13871-93; 663- K13825-12.

Pl. 38: 664- K13814-59; 665- K13814-62; 666- K13871-89; 667- K13814-32; 668- K13814-23/R271; 669- K13826-1; 670- K13871-103; 671- K13814-54; 672- K13814-18; 673- K13825-7; 674- K13814-22; 675- K13871-46; 676- K13821-2; 677- K13867-1; 678- K13814-19; 679- K13871-91; 680- K13971-52; 681- K13814-28; 682- K13871-54; 683- K13871-60; 684- K13871-99; 685- K13871-7; 686- K13871-49; 687- K13826-5.

Pl. 39: 688- K13808-106; 689- K13808-105; 690- K13808-8; 691- K13808-011; 692- K13808-009; 693- K13808-12; 694- K13808-13; 695- K13808-26; 696- K13808-24; 697- K13808-10; 698- K13808-81; 699- K13808-54.

Pl. 40: 700- K13808-52; 701- K13808-38.

Pl. 41: 702- K13808-3; 703- K13808-37; 704- K13808-51; 705- K13808-36.

Pl. 42: 706- K13808-46; 707- K13808-66; 708- K13808-70; 709- K13808-56; 710- K13808-86; 711- K13808-87; 712- K13808-28; 713- K13808-89; 714- K13808-84; 715- K13808-40.

Pl. 43: 716- K13808-49; 717- K13808-61; 718- K13808-35; 719- K13808-62; 720- K13808-55; 721- K13808-3; 722- K13808-1.

Pl. 44: 723- K13808-29; 724- K13808-22; 725- K13808-73; 726- K13808-31; 727- K13808-21; 728- K13808-32; 729- K13808-27; 730- K13808-4; 731- K13808-23; 732 a et b- K13808-98; 733- K13808-90; 734- K13808-69; 735- K13808-41; 736- K13808-43; 737- K13827-1; 738- K13866-3/R234.

Pl. 45: 739- K13248-68/R264; 740- K13866-6; 741- K16257-15; 742- K16257-12; 743- K16257-14; 744- K16257-21; 745- K16068-37; 746- K16054-4/R191; 747- K13211-1; 748- K13876-106; 749- K13866-4; 750- K16068-43; 751- K16257-8.

Pl. 46: 752- K13815-3/R251; 753- K13815-2; 754- K16257-13; 755- K16058-1; 756- K16284-2; 757- K16068-42; 758- K18754-160; 759- K18782-3; 760- K18863-11; 761- K18416-5.

Pl. 47: 762- K18780-233; 763- K18907-2; 764- K18404-17/R345; 765- K18782-4; 766- K18752-1.

Pl. 48: 767- K18907-1/R284; 768- K13830-1; 769- K13869-4; 770- K13869-5; 771- K13189-3; 772- K16328-3.

Pl. 49: 773- K13189-7; 774- K13869-7; 775- K13897-8; 776- K13869-8.

Pl. 50: 777- K13897-7; 778- K13830-5; 779- K13831-2; 780- K16061-3; 781- K13830-12; 782- K13835-9; 783- K13835-10; 784- K13830-10.

Pl. 51: 785- K16284-5; 786- K13869-9; 787- K18016-1; 788- K13869-10; 789- K13162-23; 790- K18040-9; 791- K13189-1; 792- K13189-9; 793- K13198-7/R69; 794- K13891-1; 795- K18039-4/R239; 796- K18199-1; 797- K13830-11; 798- K18201-16; 799- K13889-4; 800- K13190-9; 801- K13889-3; 802- K16469-4; 803- K16469-2; 804- K13163-5.

Pl. 52: 805- K16316-1; 806- K13198-5; 807- K13191-4; 808- K13191-5; 809- K13191-6; 810- K13196-48; 811- K13198-1.

Pl. 53: 812- K16273-1/R229; 813- K16256-2/R245; 814- K16086-1; 815- K16279-71; 816- K16259-6; 817- K18375-2; 818- K18373-2; 819- K16277-2; 820- K16262-1.

Pl. 54: 821- K18170-29; 822- K16289-66; 823- K13196-531; 824- K13196-482; 825- K16289-68; 826- K13196-526; 827- K13192-25; 828- K13196-429/R111; 829- K13191-104; 830- K13196-94/R104; 831- K13196-149/R33; 832- K13196-390/R53; 833- K13192-41; 834- K13196-195/R16; 835- K13196-195/R102; 836- K16052-30/R186.

Pl. 55: 837- K13196-233; 838- K13196-377; 839- K13191-169; 840- K13196-465; 841- K13191-170; 842- K13198-9/R38; 843- D417.

Pl. 56: 844- K13197-10/R39; 845- K13191-76; 846- K18215-58/R174; 847- K16289-42/R196; 848- K13197-69/R52; 849- K16289-58; 850- K13196-105; 851- K18170-13; 852- K13196-434; 854- K13198-6/R62.

Pl. 57: 854- K16057-1; 855- K13217-3/R263; 856- K18023-2; 857- K18029-2; 858- K13892-15; 859- K13248-27; 860- K16328-25; 861- K13876-55; 862- K16318-24; 863- K16328-12; 864- K18244-3; 865- K13212-40; 866- K13248-56; 867- K16189-8/R231; 868- K18009-6/R258; 869- K13812-4/R225; 870- K18935-2/R291.

Pl. 58: 871- K18912-3/R346; 872- K13875-3; 873- K18780-116/R298; 874- K13837-5; 875- K18776-134/R378; 876- K18368-1; 877- K13827-3/R254; 878- K13180-106; 879- K13827-5/R262; 880- K18758-44; 881- K13876-92.

Pl. 59: 882- K18934-1/R354; 883- K13843-8; 884- K13248-19; 885- K16257-54; 886- K18780-9/R376; 887- K18758-26; 888- K18378-4; 889- K18003-1; 890- K18293-14; 891- K13872-15; 892- K18011-1; 893- K18011-2; 894- K18287-2; 895- K18011-5; 896- K18011-4; 897- K18385-2; 898- K13191-362.

Pl. 60: 899- K18023-1; 900- K18007-1; 901- K18368-2; 902- K16328-4; 903- K13158-7; 904- K13189-13; 905- K18287-1; 906- K13843-9; 907- K18007-2; 908- K18011-3.

Pl. 61- 909- Z. 7-132; 910- Z. 7-131.

Pl. 62: 911- Z. 5-561; 912- Z.15/16-11; 913- Z. 12-34.

Pl. 63: 914- Z. 5-103; 915- Z. 12-103; 916- Z. 12-78; 917- Z. 12-40; 918- Z. 7-21; 919- Z. 12-1; 920- Z. 5-9/R13; 921- Z. 5-421/R56; 922- Z. 5-139/R18; 923- Z. 7-150; 924- Z. 12-102; 925- Z. 5-434/R14.

Pl. 64: 926- Z. 12-63; 927- Z. 5-258/R25; 928- Z. 15-12; 929- Z. 5-37/R12; 930- Z. 5-246; 931- Z. 5-478; 932- Z. 5-155; 933- Z. 7-97; 934- Z. 1-116; 935- Z. 7-13; 936- Z. 5-134; 937- Z. 7-17; 938- Z. 7-123; 939- Z. 7-67; 940- Z. 5-174; 941- Z. 12-51; 942- Z. 5-99; 943- Z. 12-41/R66; 944- Z. 7-110; 945- Z. 5-18; 946- Z. 5-43.

Pl. 65: 947- Z. 5-191; 948- Z. 5-66; 949- Z. 5-101; 950- Z. 7-18/R23; 951- Z. 7-33; 952- Z. 5-484; 953- Z. 5-203/R63; 954- Z. 5-401; 955- Z. 5-16/R21; 956- Z. 5-348; 957- Z. 15/16-8; 958- Z. 5-79; 959- Z. 5-97; 960- Z. 12-79/R82; 961- Z. 5-379; 962- Z. 5-6/R15; 963- Z. 12-28; 964- Z. 12-17/R78; 965- Z. 15-10.

Pl. 66: 966- Z. 1-112; 967- Z. 5-497/R9; 968- Z. 7-90; 969- Z. 12-88; 970- Z. 5-486; 971- Z. 5-411; 972- Z. 5-255; 973- Z. 12-108; 974- Z. 5-100/R26; 975- Z. 5-430; 976- Z. 5-7; 977- Z. 5-534; 978- Tr. 11-1; 979- Z. 12-61/R54; 980- Z.12-97/R70.

Pl. 67: 981- Z. 5-140; 982- Z. 5-344; 983- Z. 5-10; 984- Z. 1-99; 985- Z. 12-86; 986- Z. 5-105; 987- Z. 5-429; 988- Z. 5-552/R62; 989- Z. 1-98; 990- Tr. 3-1A; 991- Tr. 3-11 B; 992- Str. 3-3; 993- Z. 5-104; 994- Z. 5-498; 995- Z. 5-208; 996- Z. 12-69; 997- Z. 12-2; 998- Z. 5-46; 999- Z. 7-10; 1000- Z. 7-95; 1001- Z. 7-116; 1002- Z. 5-238; 1003- Z. 5-135; 1004- Z. 7-105/R60; 1005- Z. 5-98; 1006- Z. 12-91/R68; 1007- Z. 5-114; 1008- Z. 12-75; 1009- Z. 1-115.

Pl. 68: 1010- Z. 5-551; 1011- Z. 5-183/R28; 1012- Z. 5-549; 1013- Z. 15/16-9; 1014- Z. 12-18; 1015- Z. 5-240; 1016- Z. 5-189; 1017- Z. 5-146; 1018- Z. 7-89; 1019- K18311-1; 1020- K18973-1; 1021- K16131-4; 1022- K22570-1.

Pl. 69: 1023- K16130-2; 1024- K16130-7; 1025- K16130-5; 1026- K16130-4; 1027- K16131-15/R2; 1028- K18120-5; 1029- K16131-28; 1030- K16131-25; 1031- K18323-8; 1032- K16131-7; 1033- K22583-3; 1034- K16113-1; 1035- K16130-16; 1036- K16130-6; 1037- K18119-4; 1038- K18324-14; 1039- K16035-5; 1040- K18139-14.

Pl. 70: 1041- K18106-3; 1042- K18132-8; 1043- K18986-5; 1044- K22709-1; 1045- K18113-1; 1046- K18119-13; 1047- K18953-6; 1048- K19000-1; 1049- K16130-12.

Pl. 71: 1050- K18119-2/R30; 1051- K16131-12/R1; 1052- K16131-16; 1053- K18120-2; 1054- K18120-3; 1055- K16110-4.

Pl. 72: 1056- K16043b-5/R24; 1057- K16101-7; 1058- K16038-5; 1059- K16131-18/R4.

Pl. 73: 1060- K16130-1; 1061- K22564-1/R106; 1062- K16133-3; 1063- K18312-3; 1064- K18113-3; 1065- K16131-32; 1066- K18953-4; 1067- K16131-31; 1068- K16373-1; 1069- K22564-14; 1070- K18349-10; 1071- K18120-4; 1072- K16130-14; 1073- K16135-5; 1074- K18119-6/R33.

Pl. 74: 1075- K18120-1; 1076- K16130-15; 1077- K16110-5; 1078- K18119-9; 1079- K16131-9.

Pl. 75: 1080- K16128-3; 1081- K16105-1; 1082- K18312-5; 1083- K18340-9; 1084- K16130-17; 1085- K16373-2; 1086- K18106-1; 1087- K16131-8; 1088- K16378-1; 1089- K18348-3; 1090- K18119-10/R31; 1091- K18121-2; 1092- K16130-3; 1093- K16130-8.

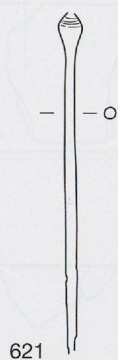

621

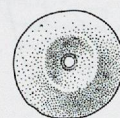

622

5 cm



623

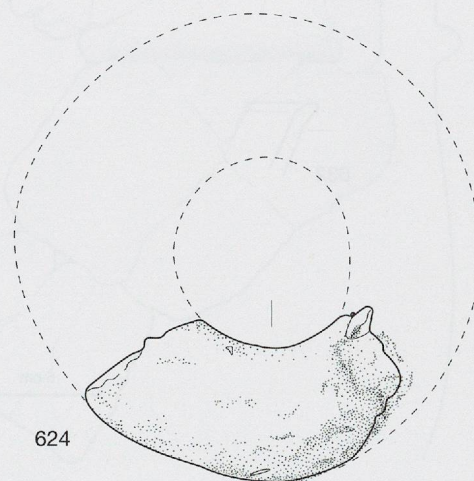

624



625

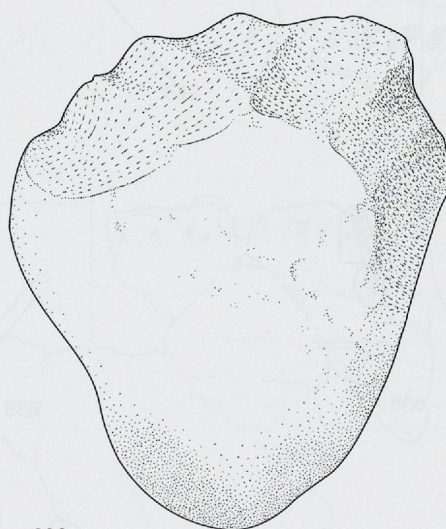

626



351

Onnens VD-Clos Dessous (éch. 1/2). Bronze. 621: épingle. Terre cuite. 622: fusaïole. 623: flanc de croissant. 624: anneau. Pierre. 625: lissoir. 626: galet taillé.

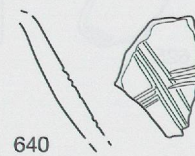
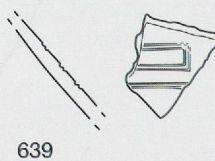
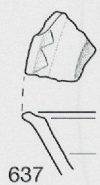
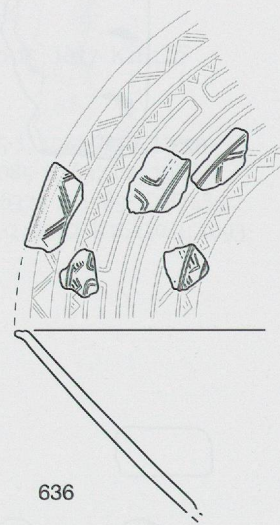
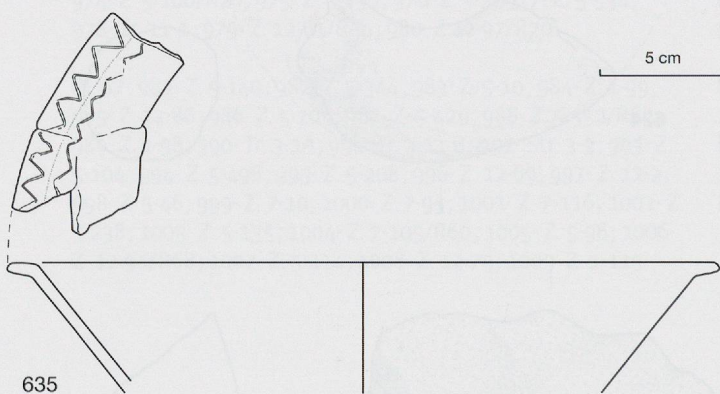
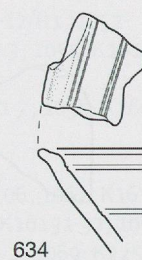
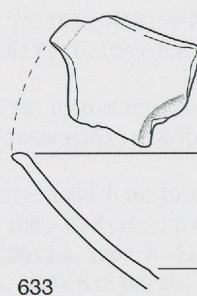
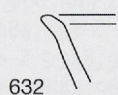
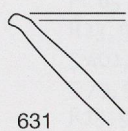
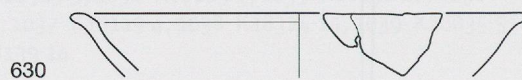
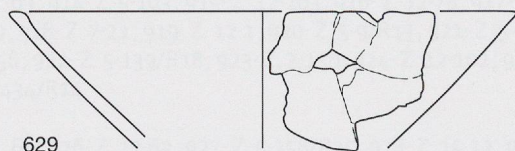
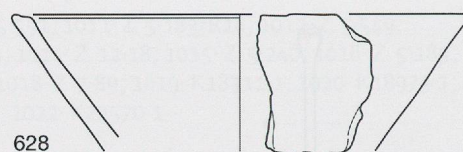
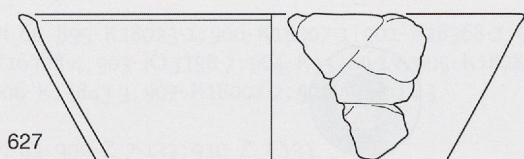

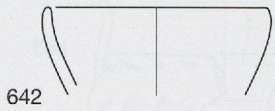

642

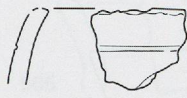

643

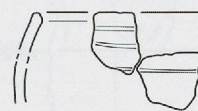

644



645

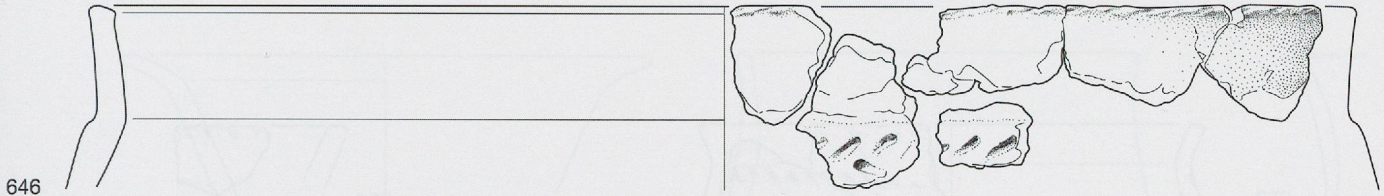

646

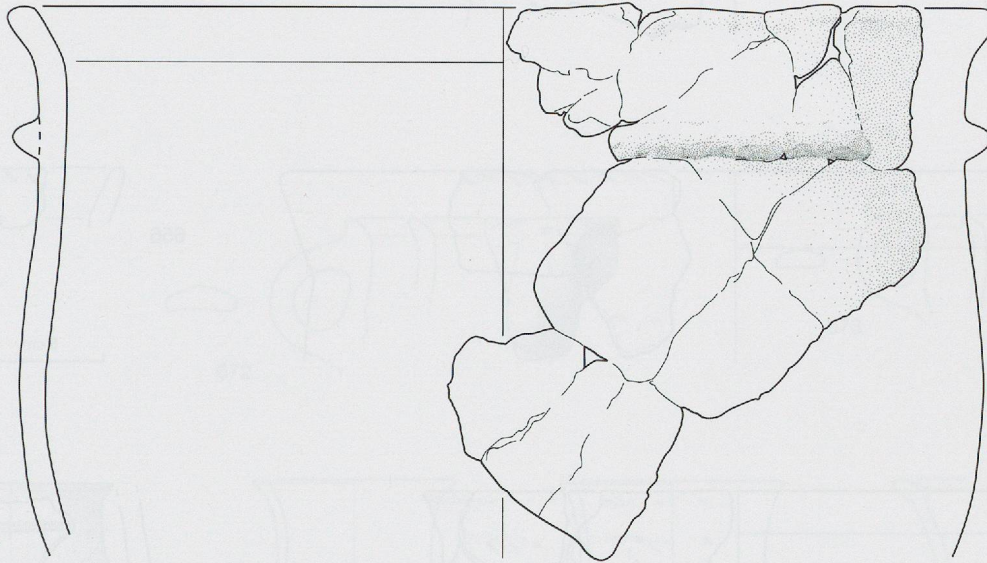

647

5 cm

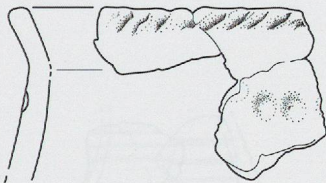

648

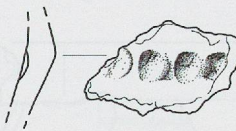

649



650

Onnens VD-Clos Dessous (éch. 1/3). 642-645: bols. 646-650: pots en pâte grossière.

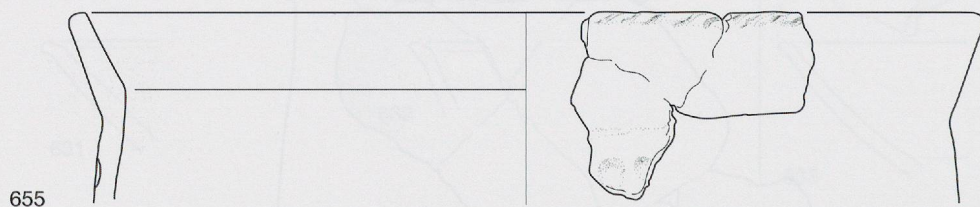
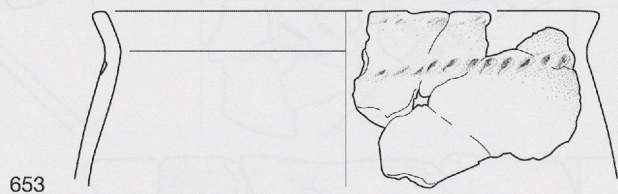
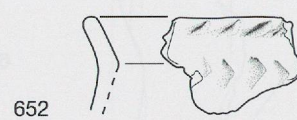
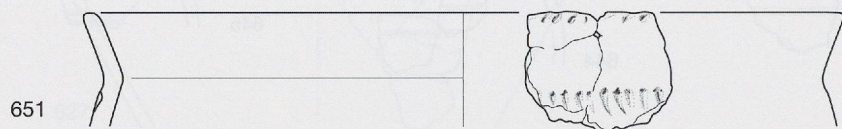

5 cm

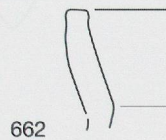
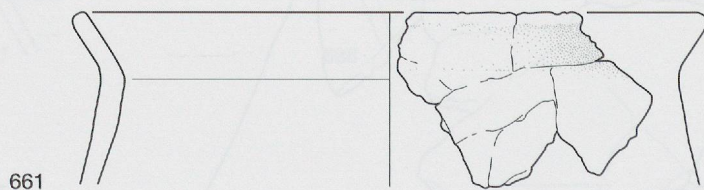
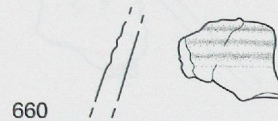
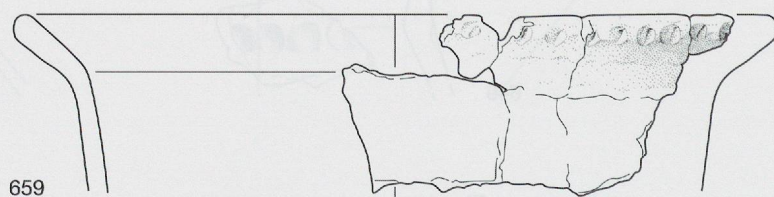
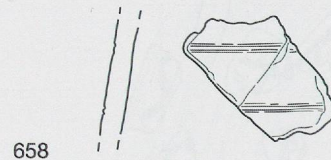
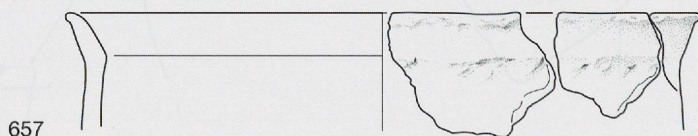

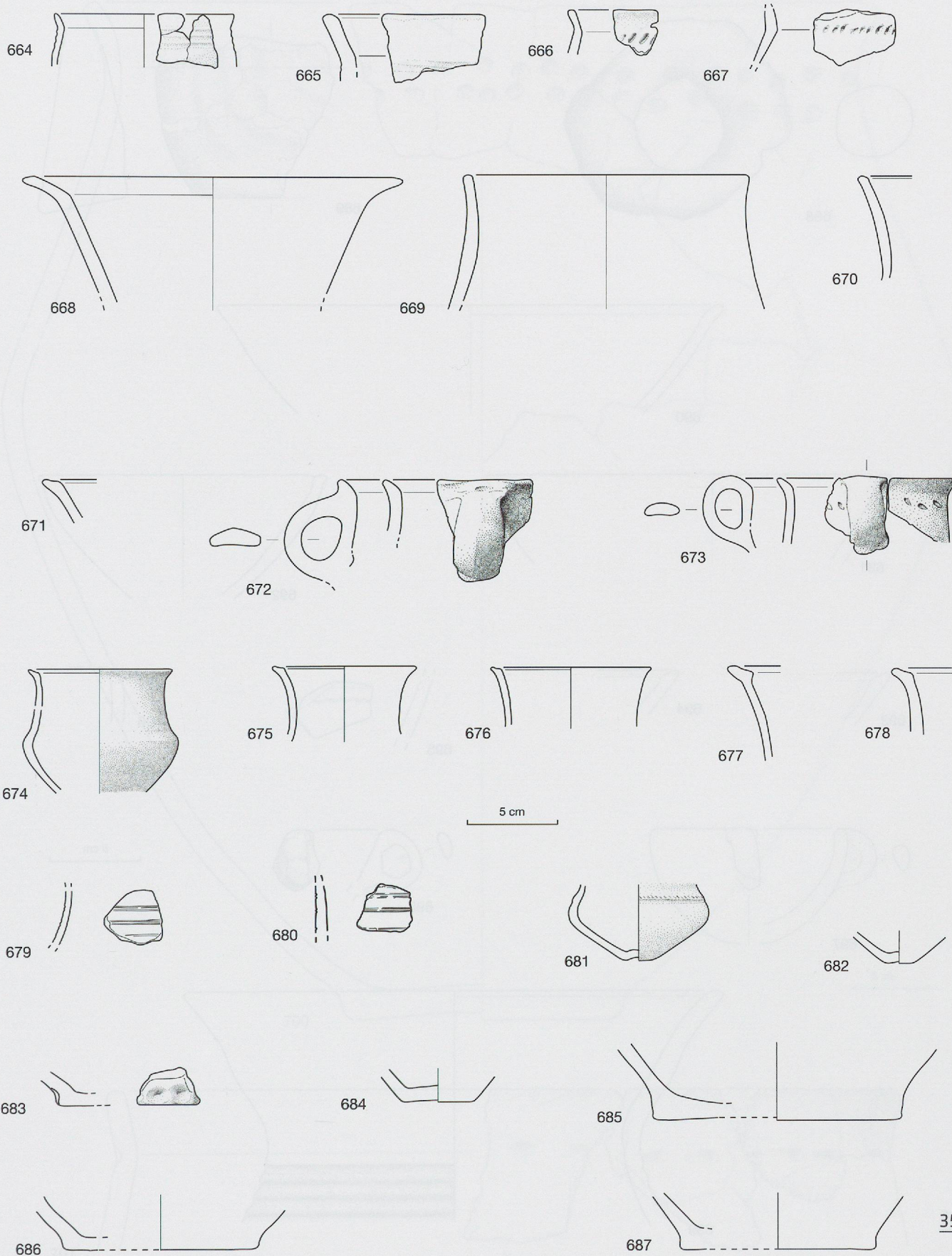

Onnens VD-Clos Dessous (éch. 1/3). 664-671: pots en pâte fine et moyenne. 672-673: pichets. 674-678: gobelets à épaulement. 679-681: panses décorées. 682-687: fonds.

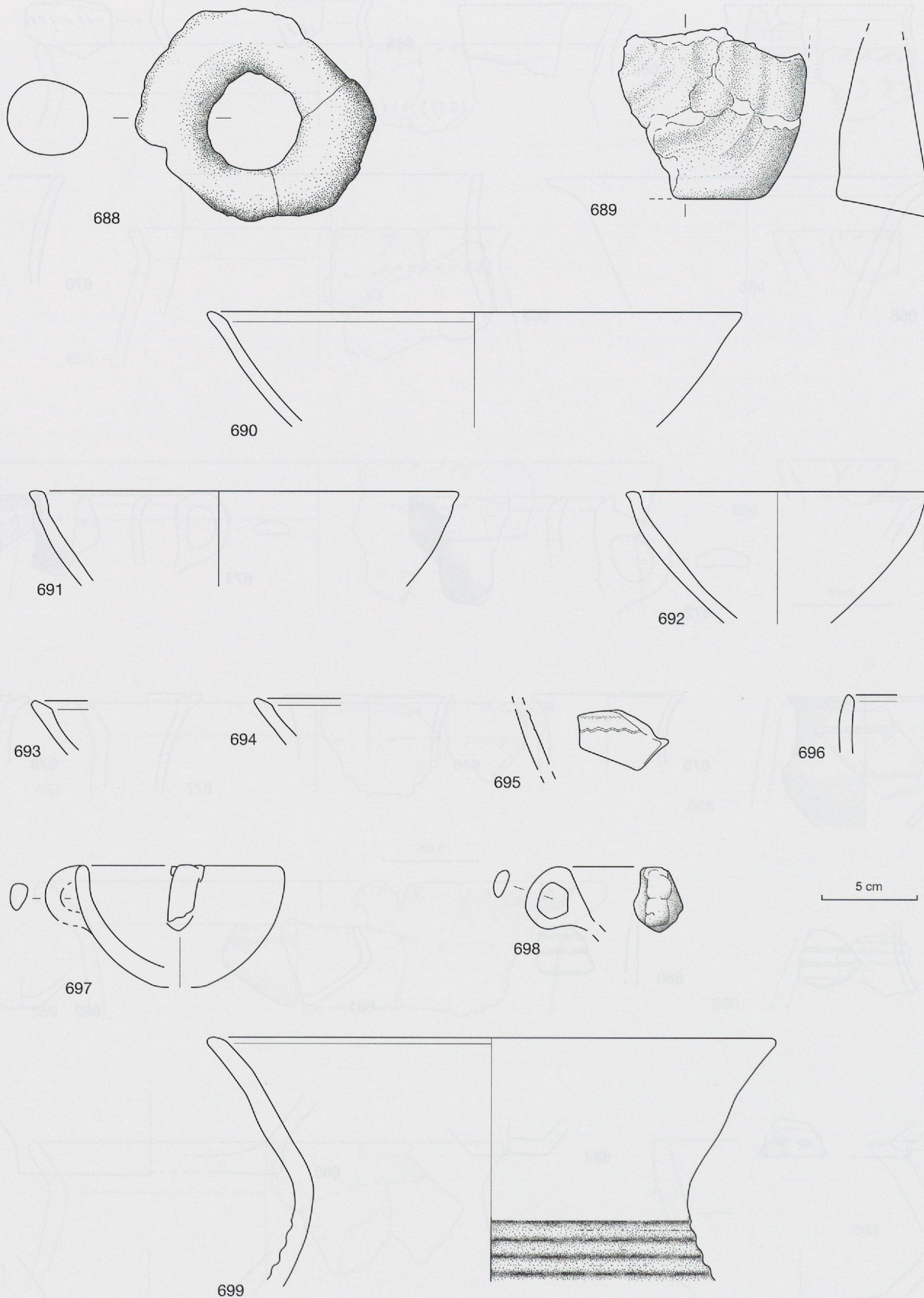

Onnens VD-Le Motti (éch. 1/3). Mobilier de la zone de rejet nord. Terre cuite. 688 : anneau. 689 : croissant. Céramique. 690-695 : écuelles. 696 : bol. 697-698 : tasses. 699 : pot en pâte grossière à bord en entonnoir.

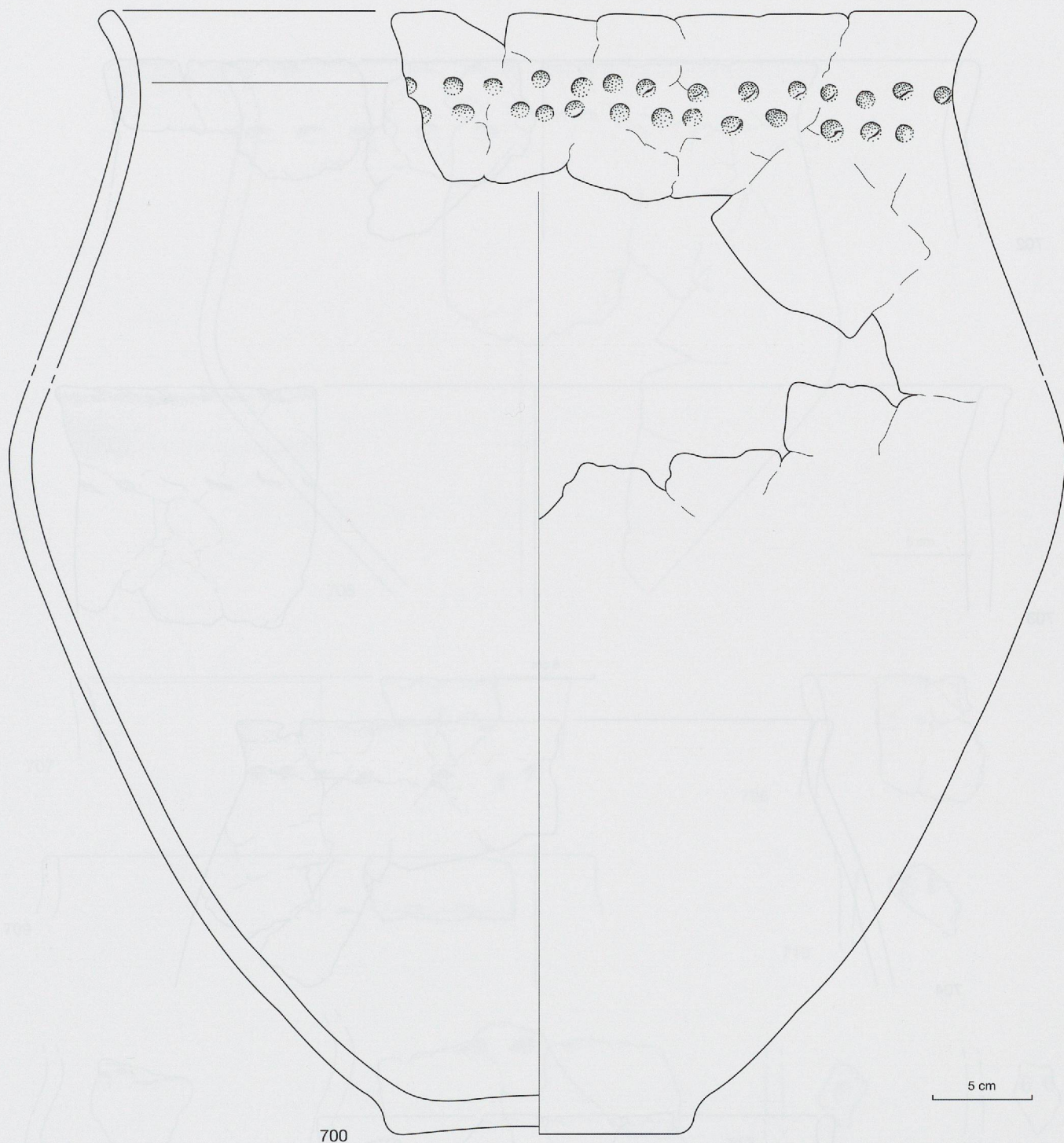

700

5 cm

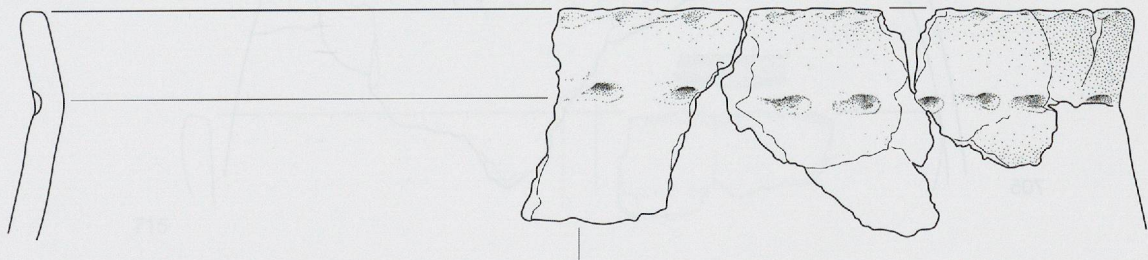

701

357

Onnens VD-Le Motti (éch. 1/3). Pots en pâte grossière.

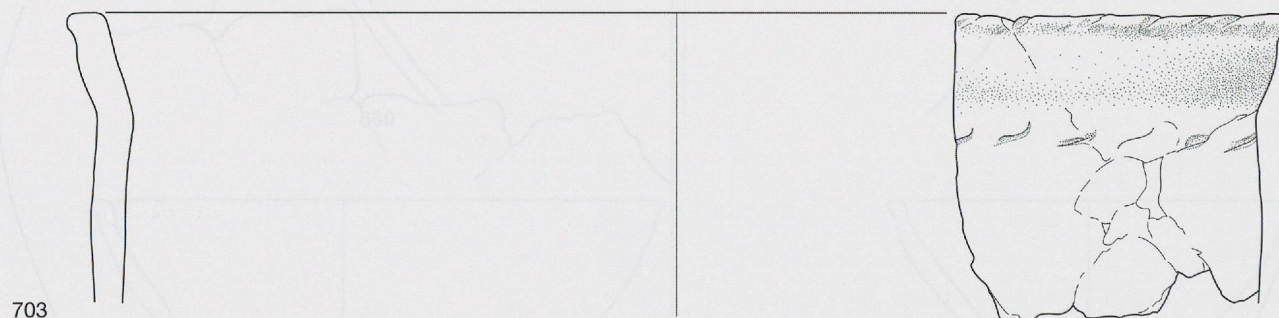
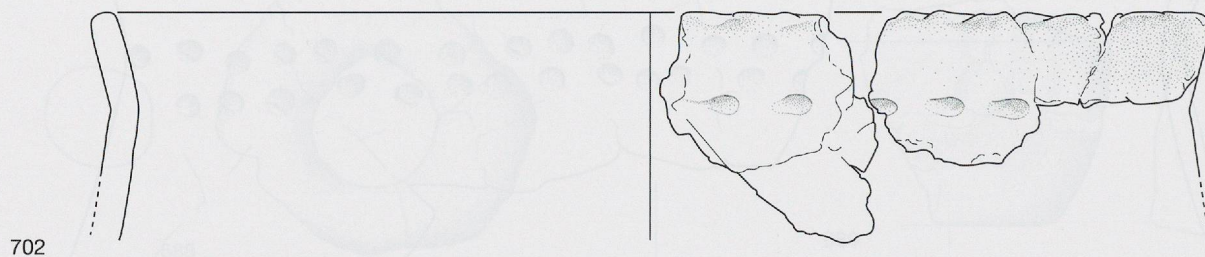

5 cm

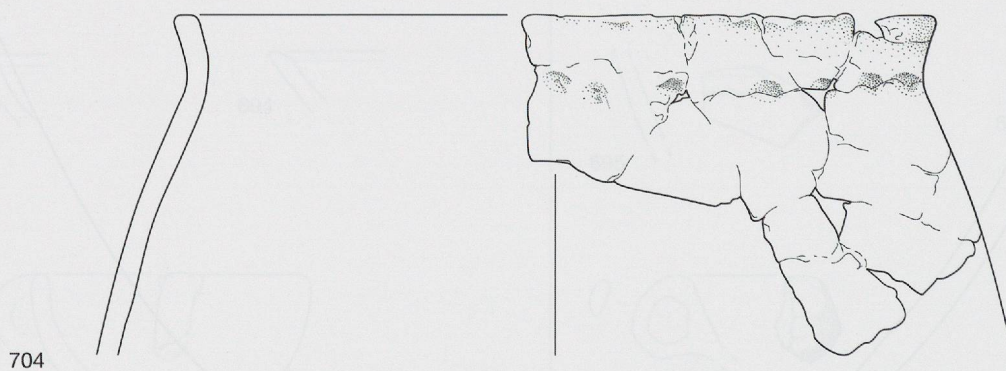

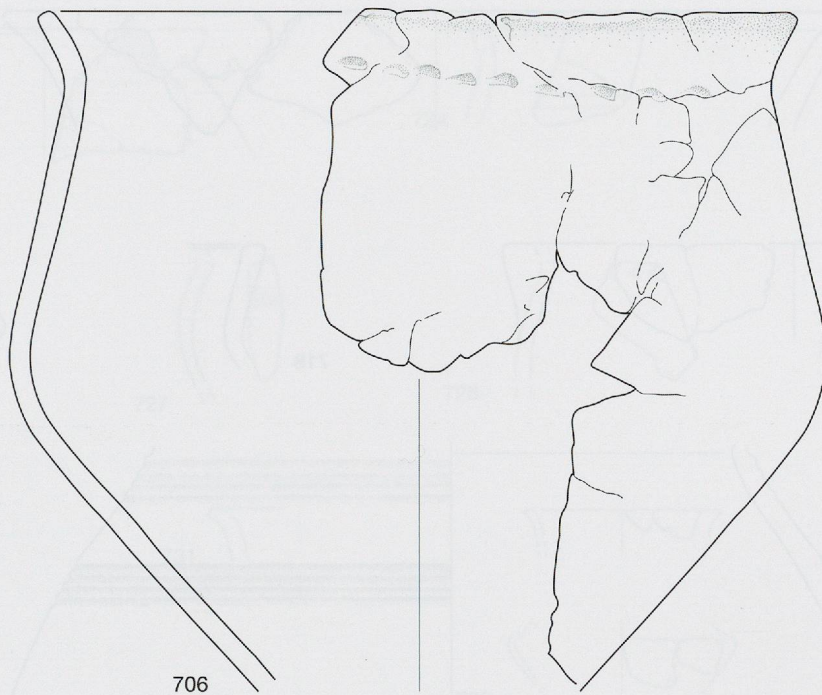

5 cm

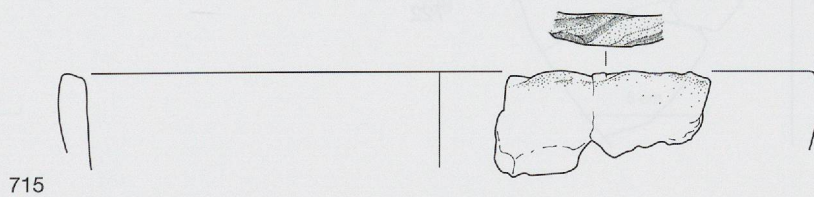
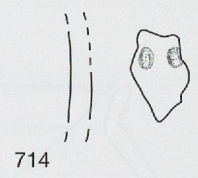
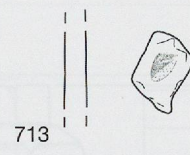
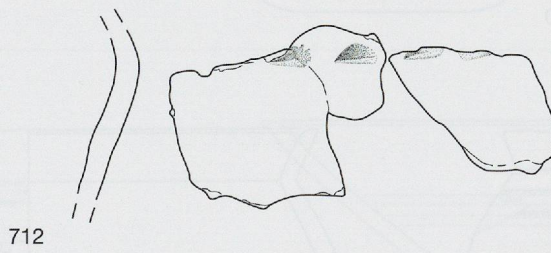
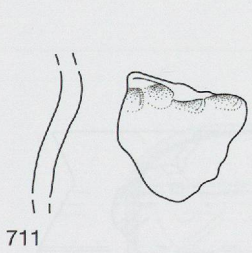
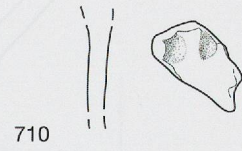
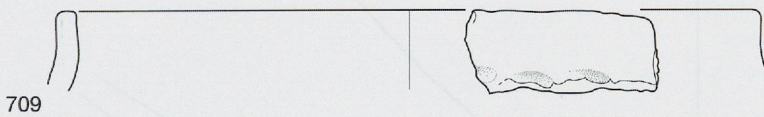
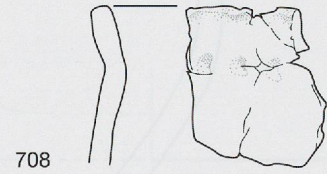
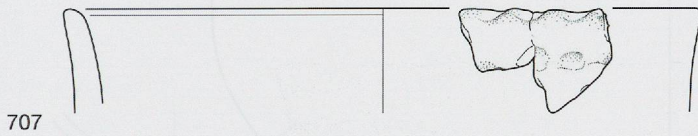

Onnens VD-Le Motti (éch. 1/3). Pots en pâte grossière.

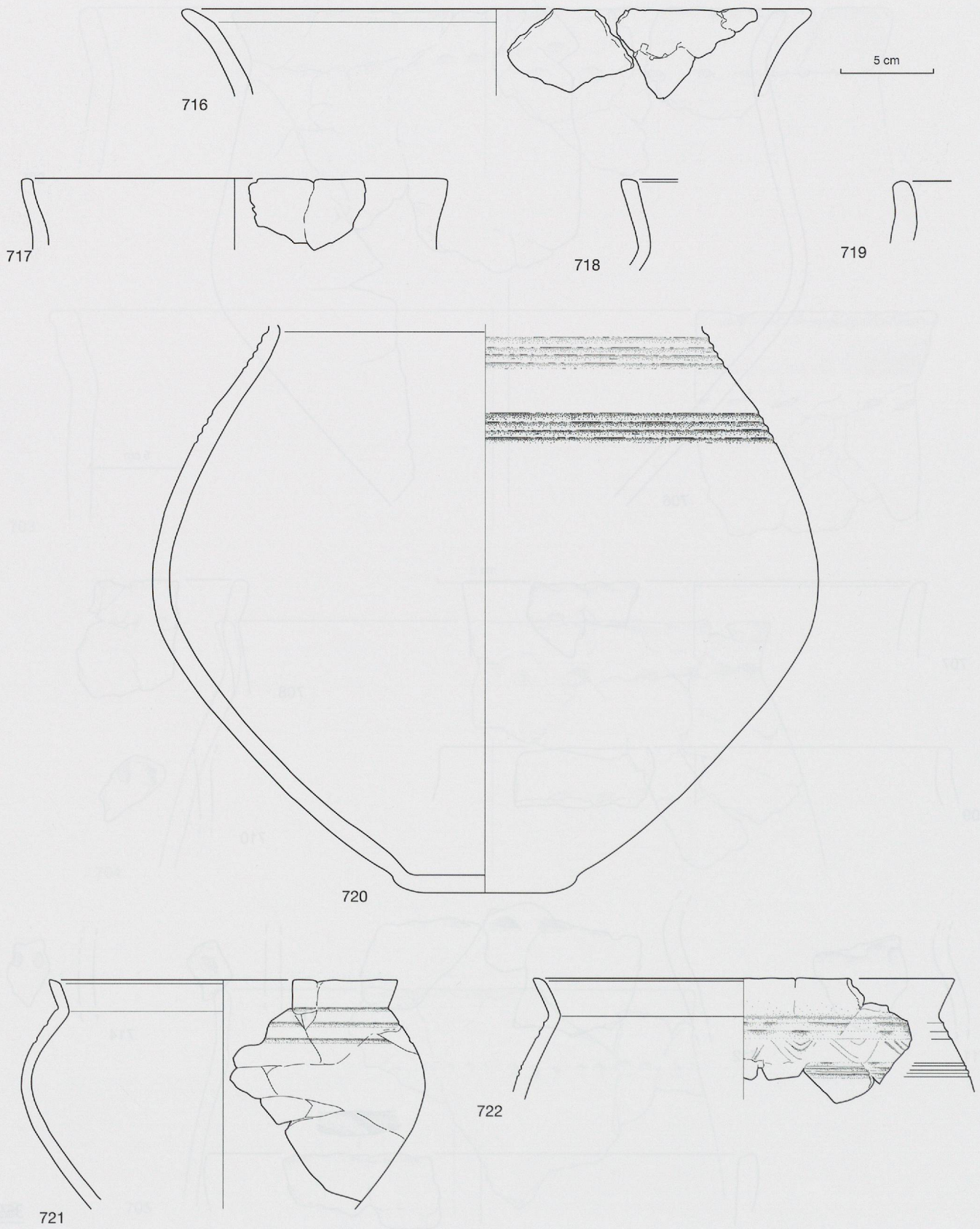

Onnens VD-*Le Motti* (éch. 1/3). 716-719 : pots en pâte grossière. 720-722 : pots en pâte moyenne.

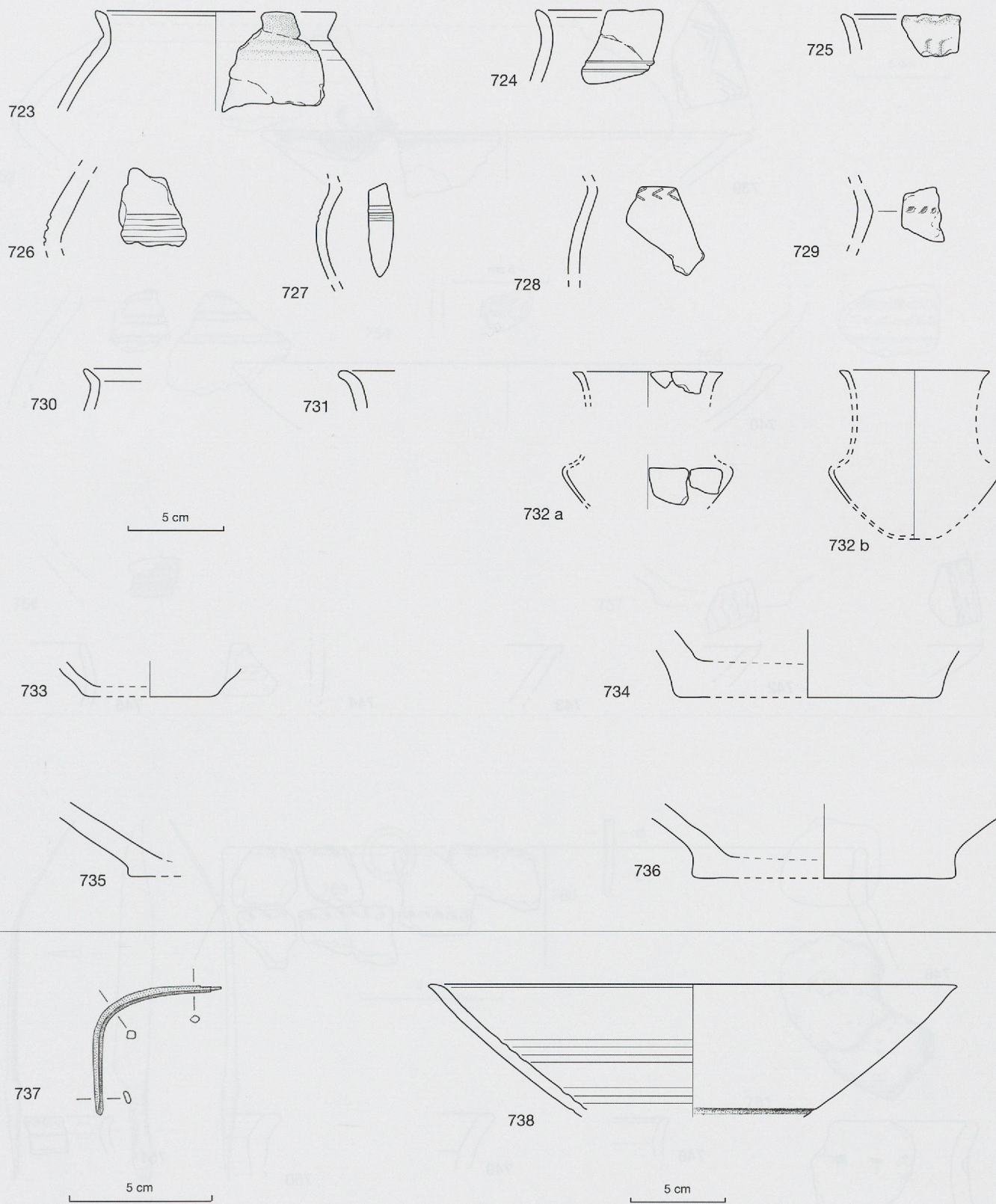

Onnens VD-*Le Motti*. (éch. 1/3). 723-731: pots en pâtes moyenne et fine. 732 (a): gobelet à épaulement. 732 (b): reconstitution.
 733-736: fonds.
 Mobilier du versant de la colline. Bronze (éch. 1/1). 737: ciselet. Céramique (éch. 1/3). 738: écuelle.

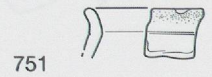
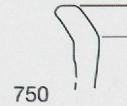
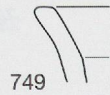
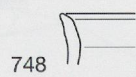
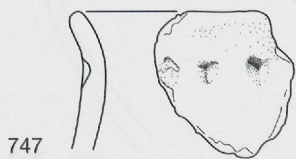
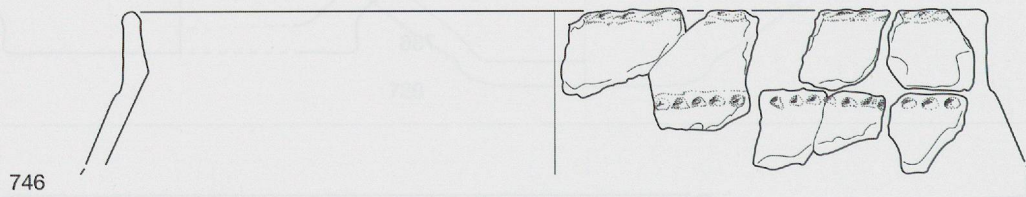
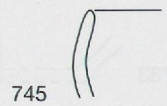
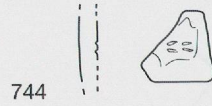
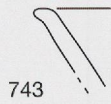
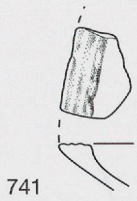
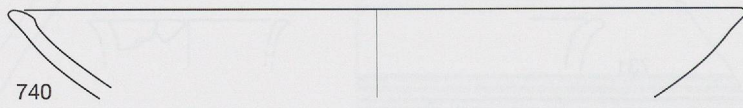
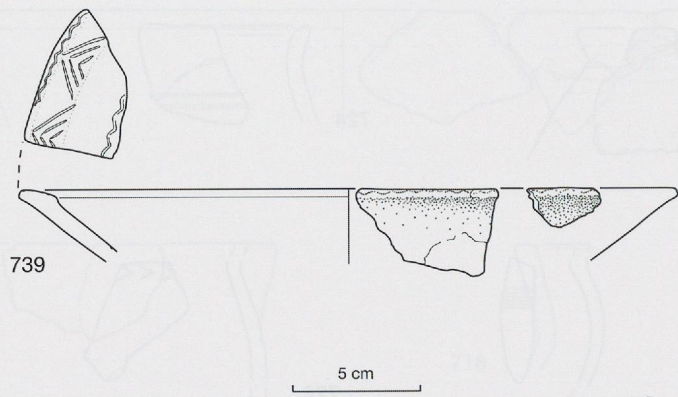

Onnens VD-Le Motti (éch. 1/3). 739-744: écuelles. 745: jatte. 746-747: pots en pâte grossière. 748-751: pots en pâte fine et moyenne.

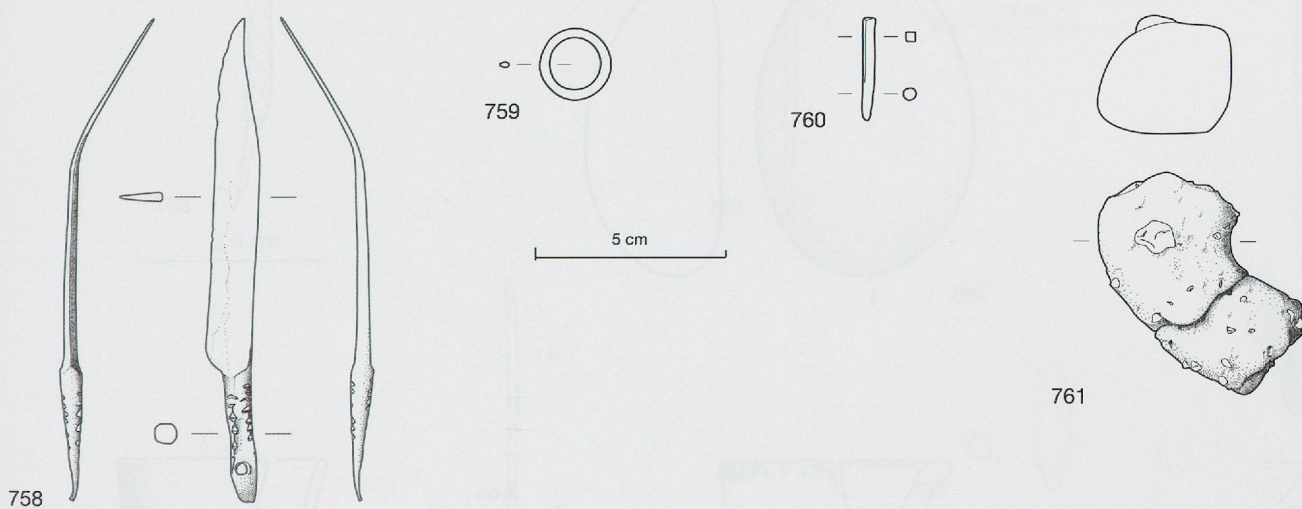
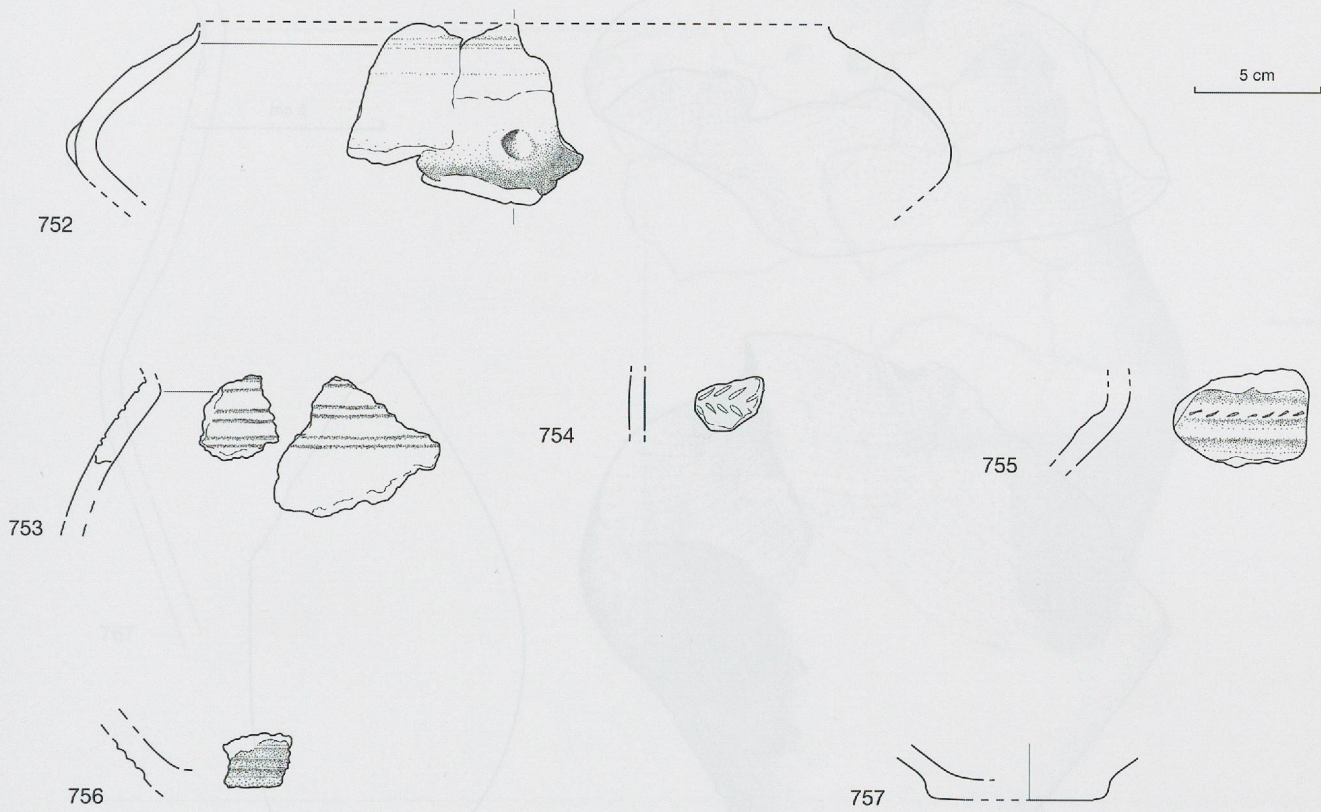

Onnens VD-Le Motti (éch. 1/3). 752-755 : panses décorées. 756-757 : fonds.
 Mobilier de la rive droite du Pontet. Bronze (éch. 1/2). 758 : couteau. 759 : anneau. 760 : tige. Terre cuite (éch. 1/2). 761 : anneau.

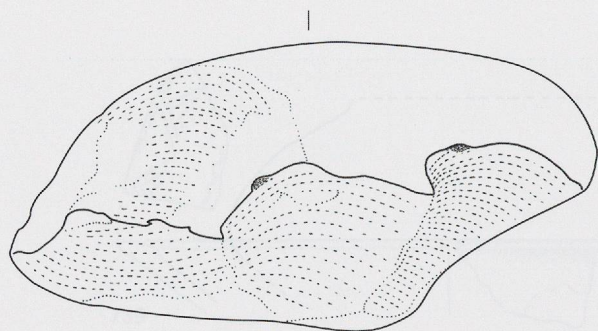

5 cm

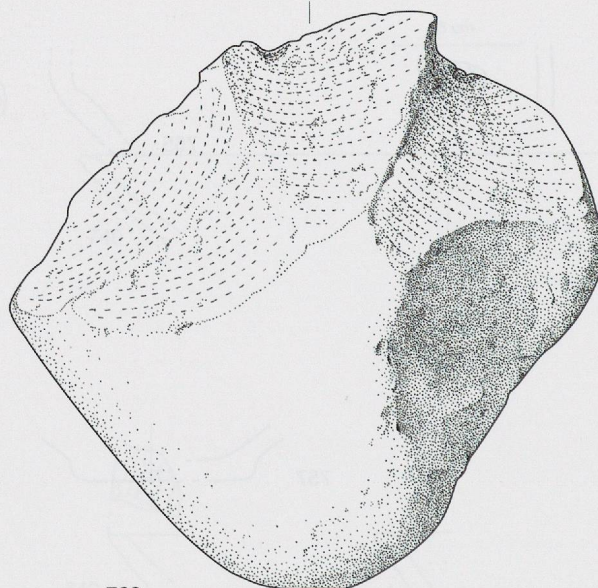

762

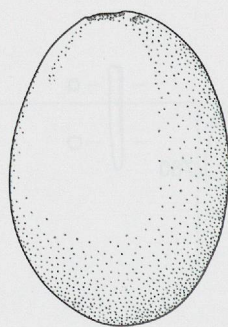

763



764



765

5 cm



766

Onnens VD-*Le Motti*. Pierre (éch. 1/2). 762: galet taillé. 763: percuteur. Céramique (éch. 1/3). 764: écuelle. 765: pot en pâte grossière. 766: gobelet à épaulement miniature.

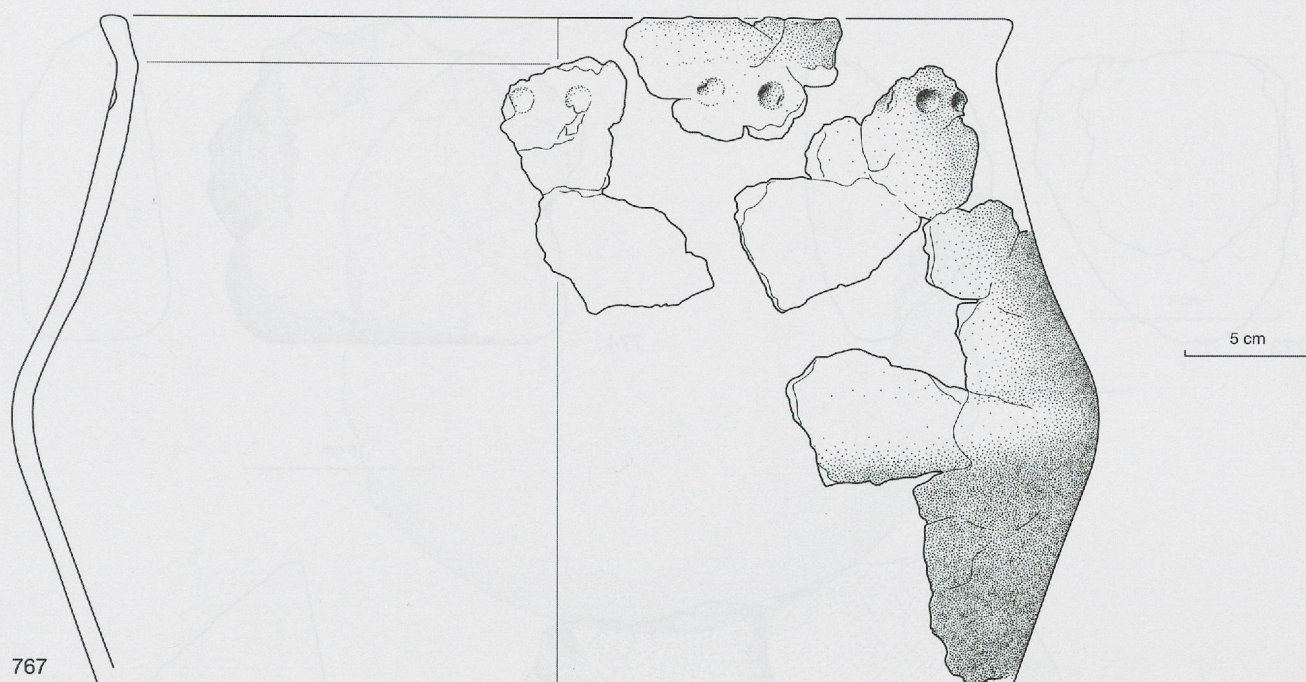

767

5 cm

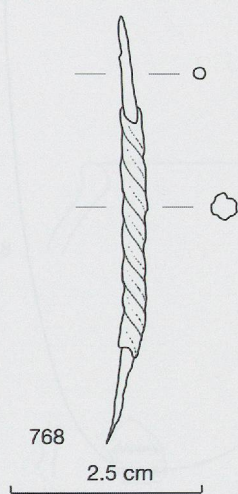

768

2.5 cm

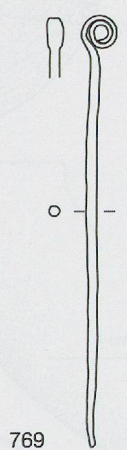

769

5 cm



770

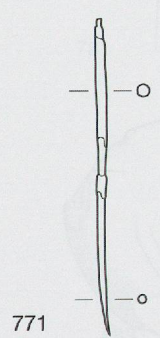

771

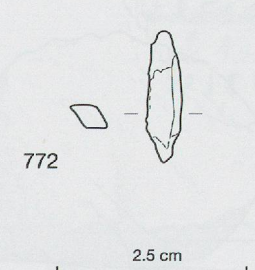

772

2.5 cm

Onnens VD-Le Motti (éch. 1/3). 767: pot en pâte grossière.
 Mobilier de la solifluxion. Bronze. 768: épingle (éch. 1/1). 769-771: épingles (éch. 1/2). 772: poinçon (éch. 1/1).

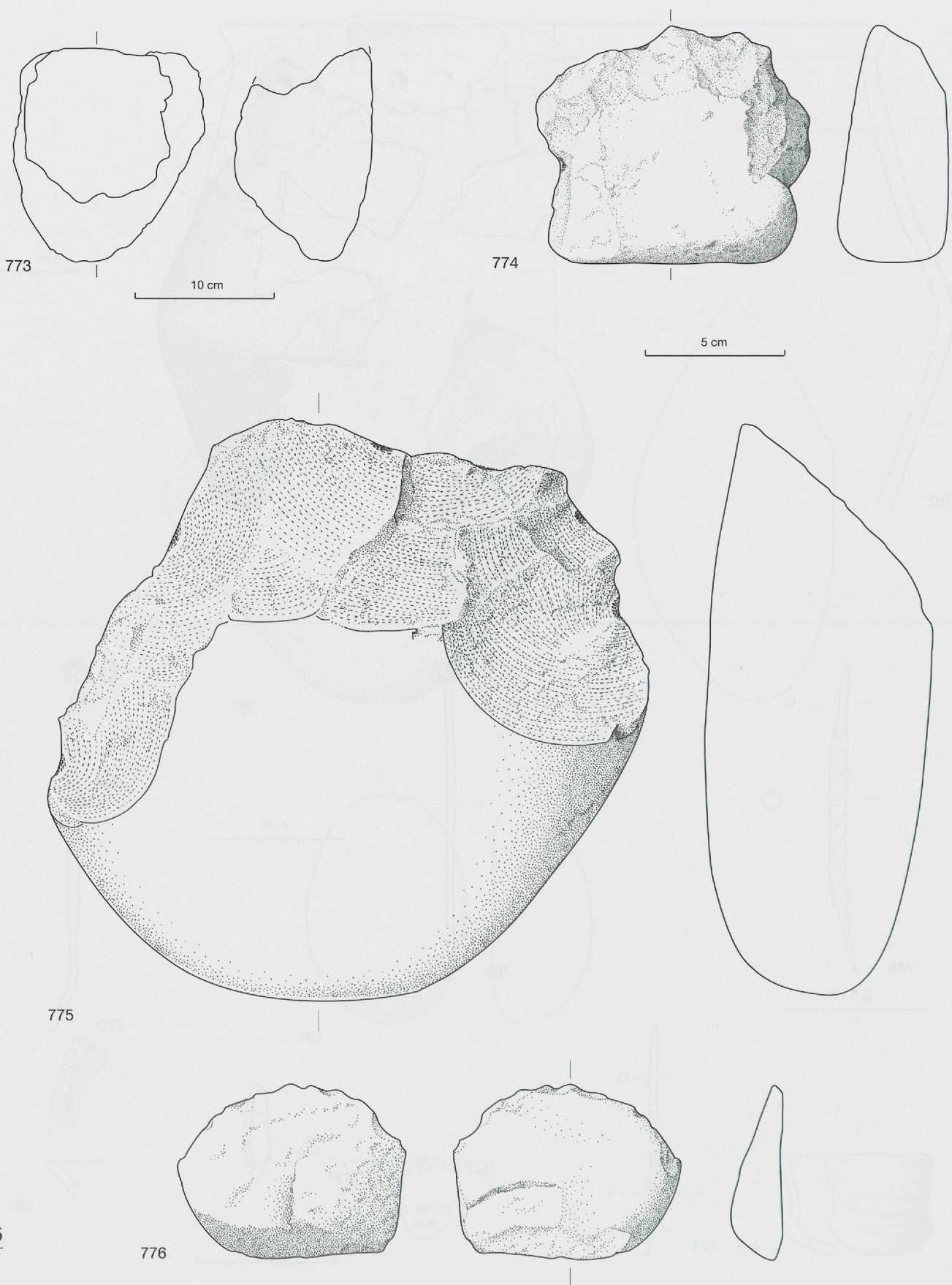

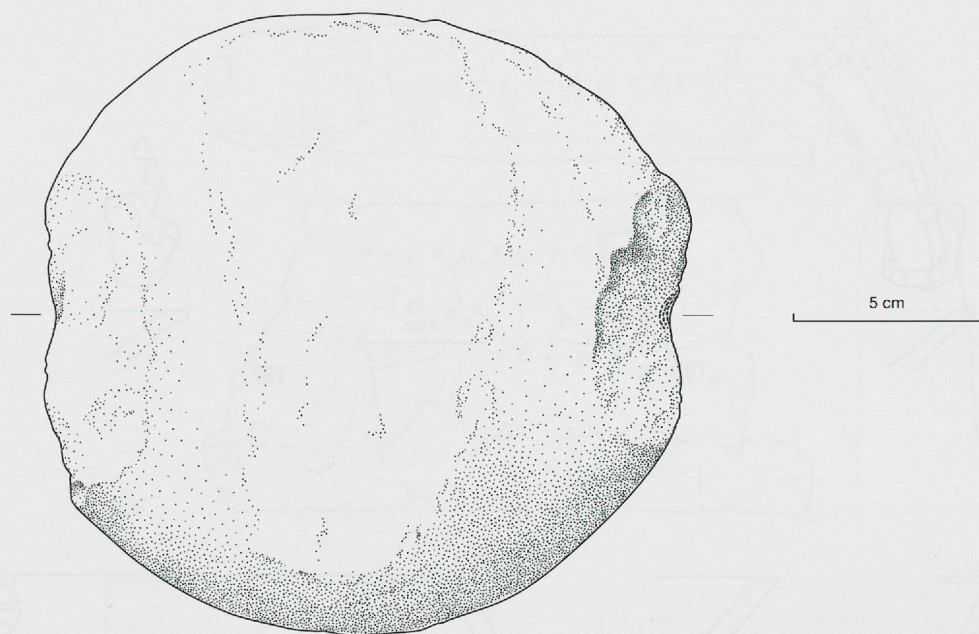

777

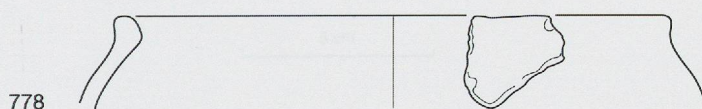
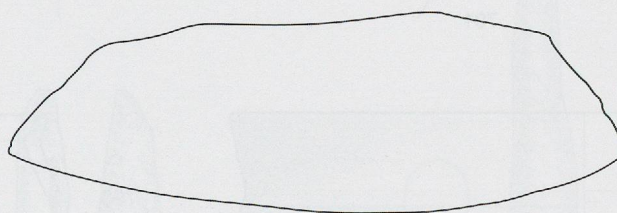

778

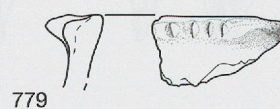

779

5 cm

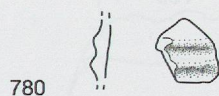

780



781



782



783

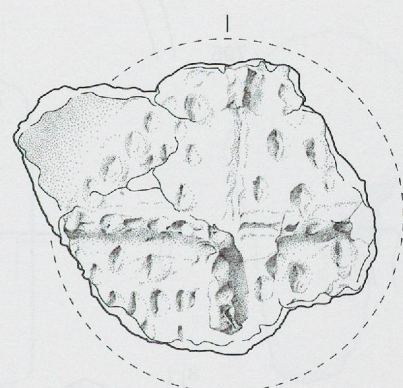

784

Onnens VD-Le Motti. 777: galet encoché (éch. 1/2). Céramique antérieure au HaB (éch. 1/3). 778: pot en pâte grossière. 779: bord rentrant. 780-782: panses décorées. 783-784: fonds.

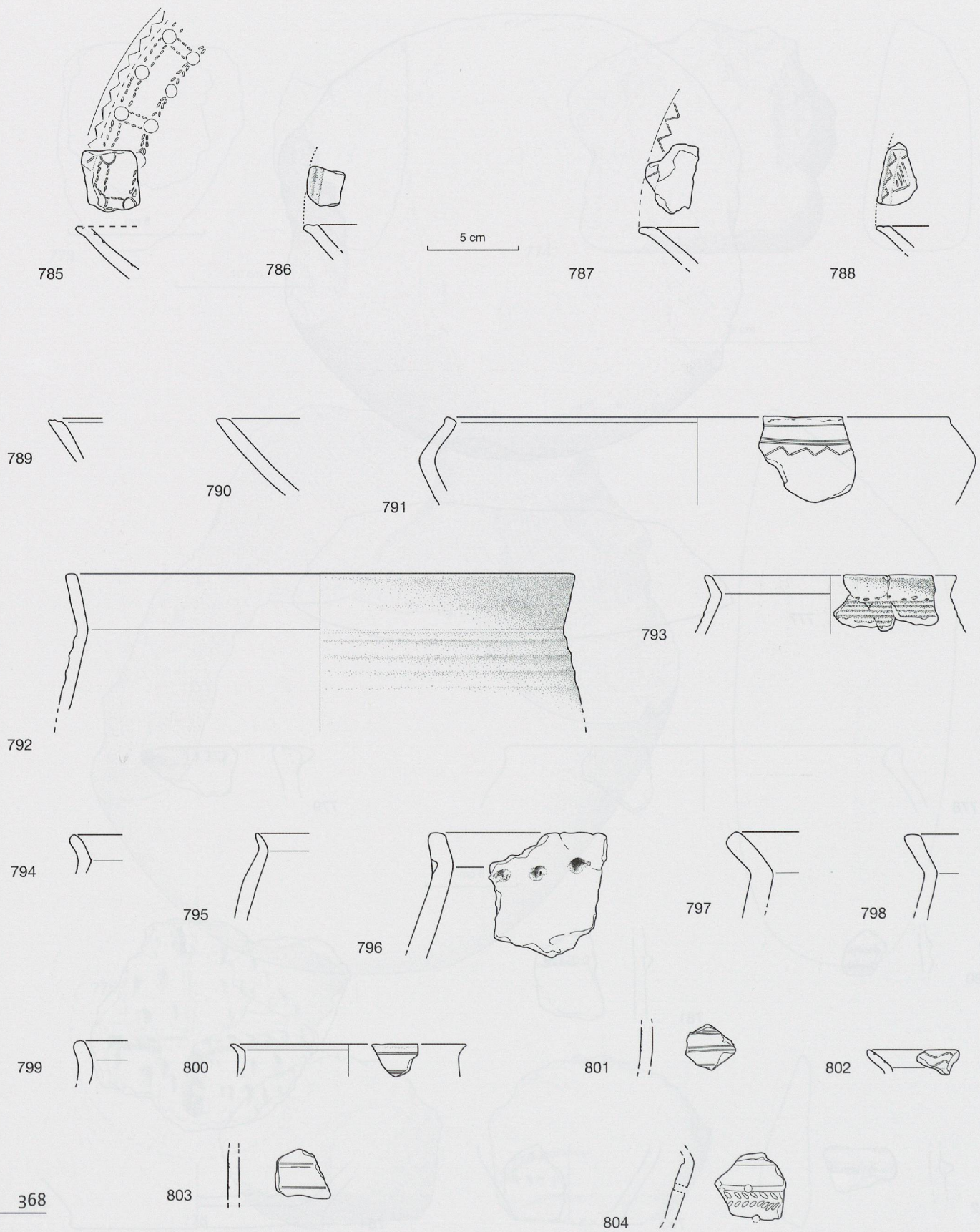

Onnens VD-Le Motti (éch. 1/3). Céramique attribuée au HaB. 785-790: écuelles. 791: jatte. 792-795: pots en pâte fine et moyenne. 796-799: pots en pâte grossière. 800-801: gobelets à épaulement. 802: bord. 803-804: panses décorées.

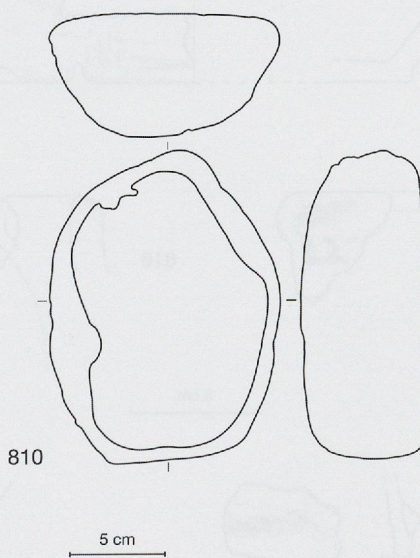
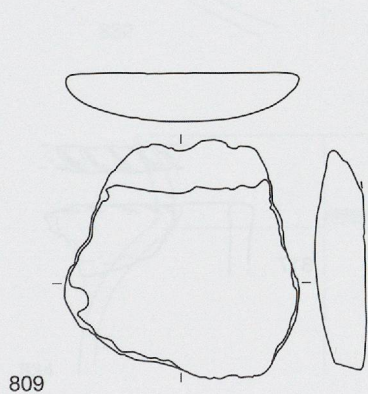
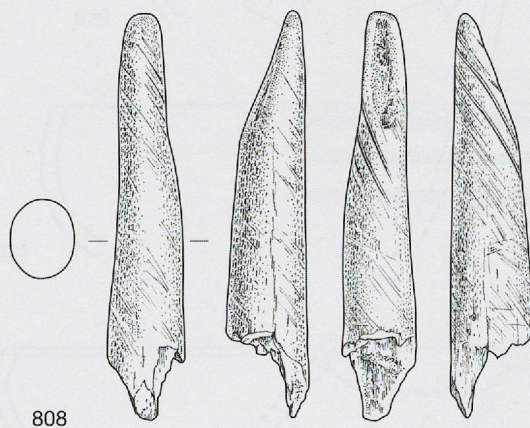
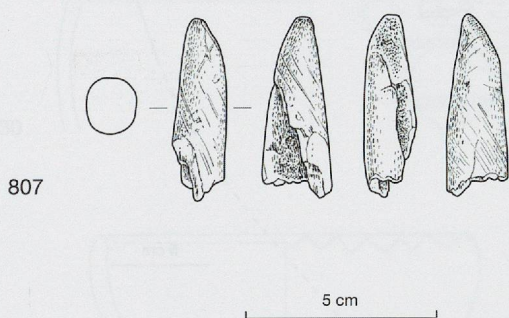
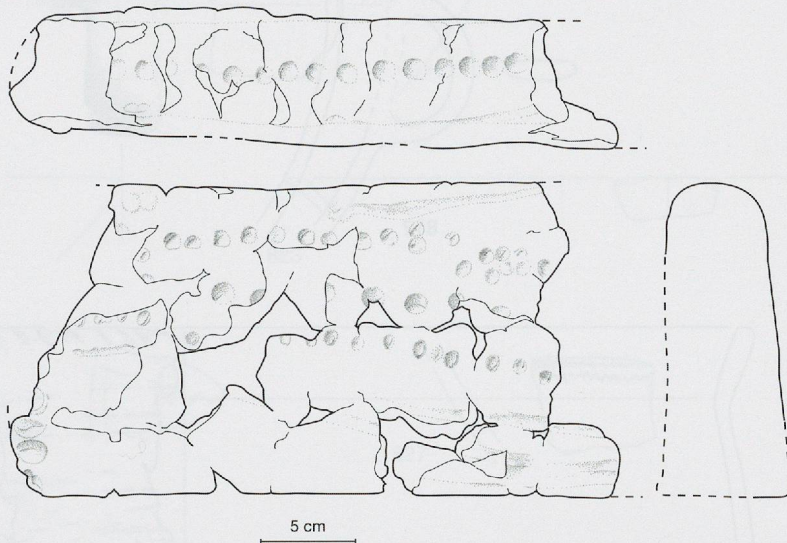
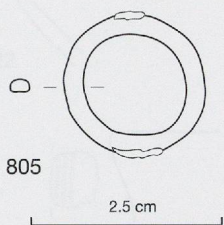

Onnens VD-*Le Motti*. Mobilier de la zone marécageuse. Bronze (éch. 1/1). 805: anneau. Terre cuite (éch. 1/4). 806: croissant. Bois de cerf (éch. 1/2). 807-808: andouillers. Pierre (éch. 1/4). 809-810: matériel de mouture. 811: galet encoché.

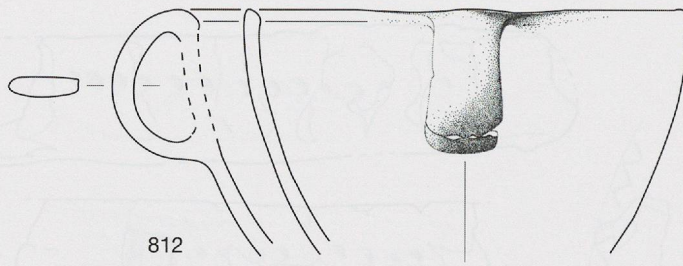

812

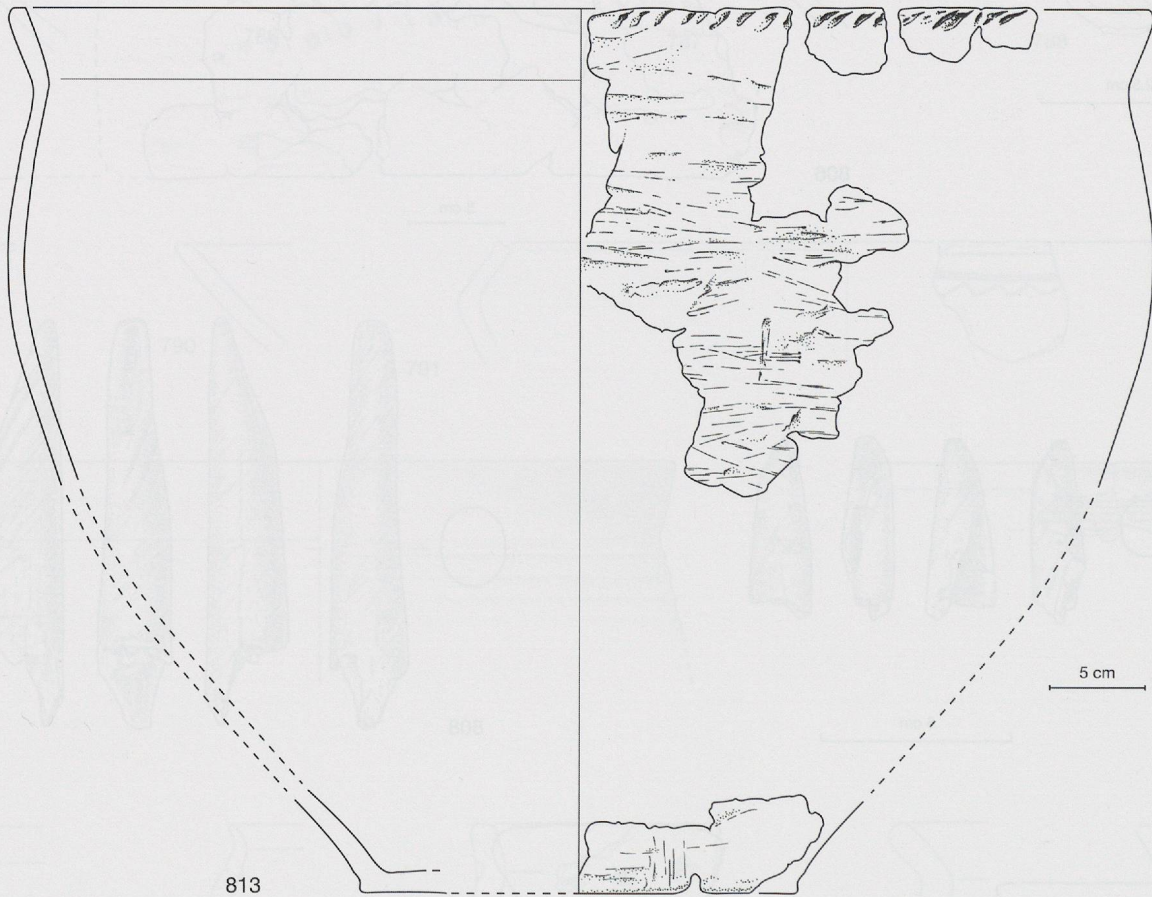

813

5 cm

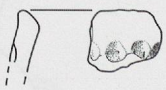

814

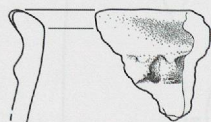

815

816

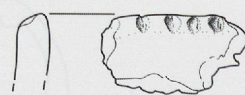

5 cm

817



818



819



820

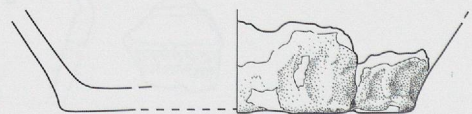

Onnens VD-Le Motti (éch. 1/3 et 1/4). Céramique antérieure au HaB. 812: tasse. 813: pot (éch. 1/4). 814: bol. 815-818: bords. 819: panse décorée. 820: fond.

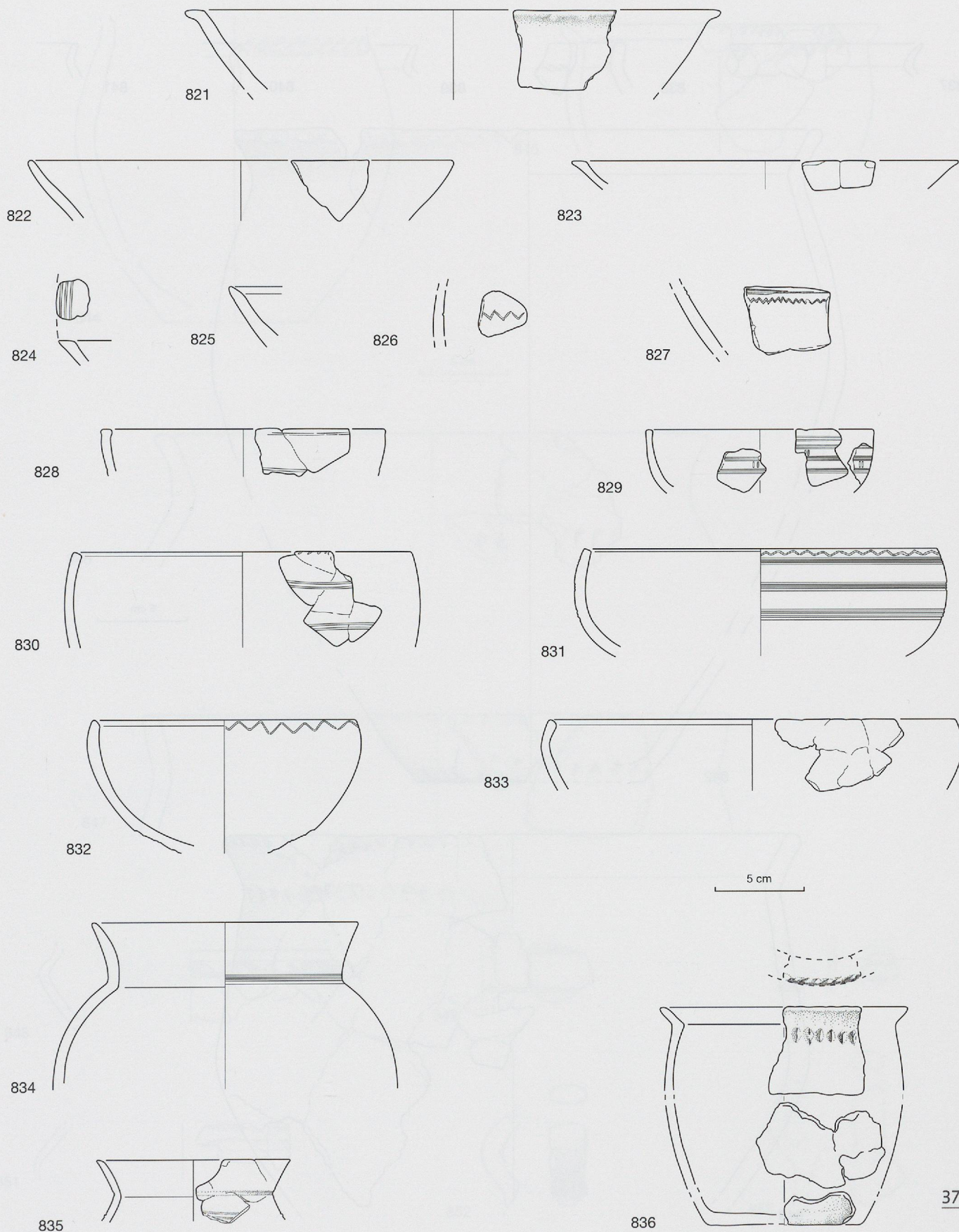

Onnens VD-*Le Motti* (éch. 1/3). Céramique attribuée au HaB. 821-827 : écuelles. 828-832 : bols. 833 : jatte. 834-836 : pots en pâte fine et moyenne.

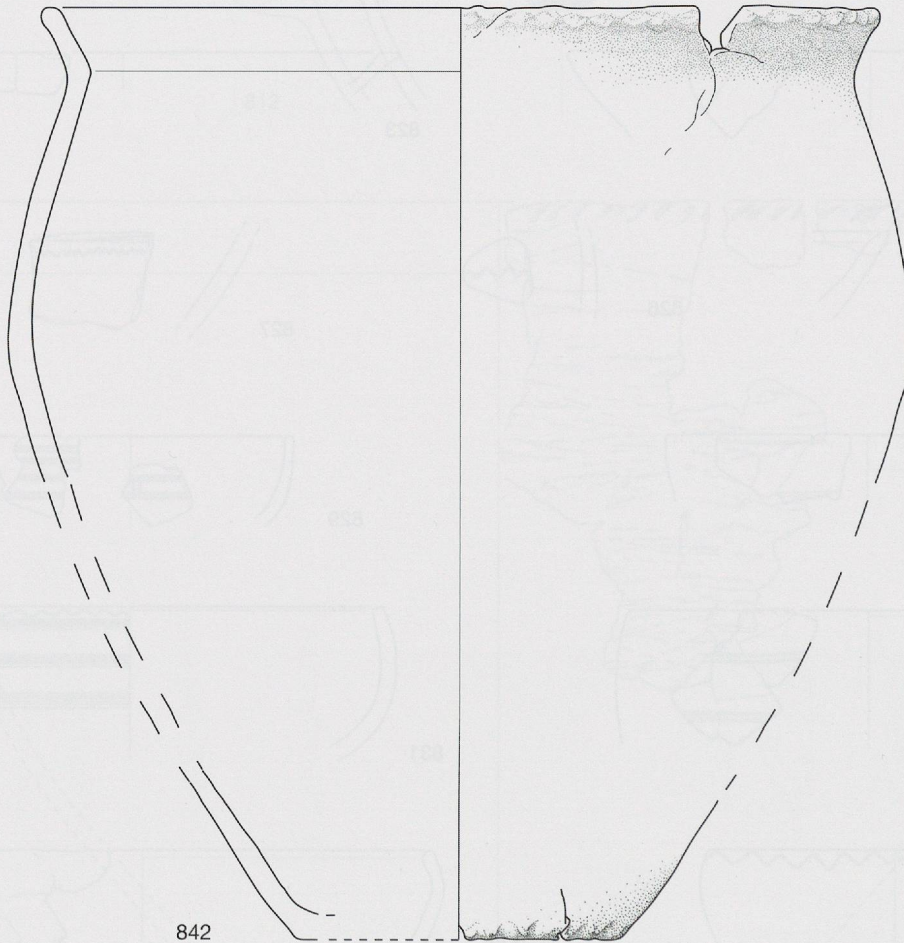
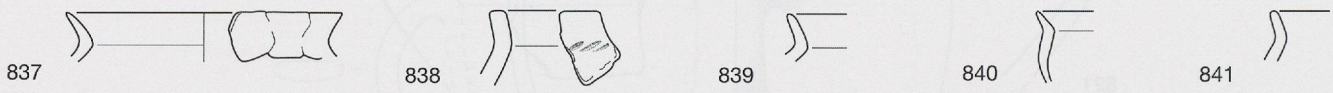

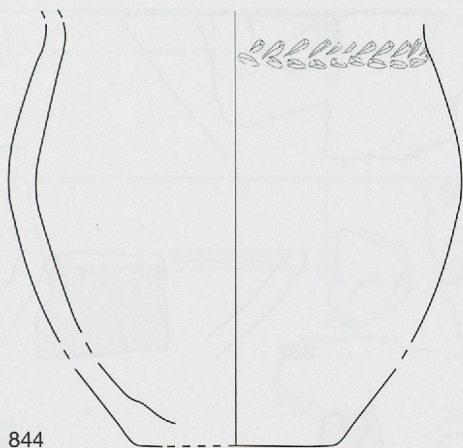

844

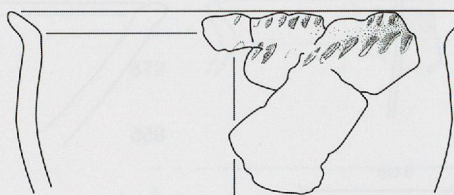

845

5 cm

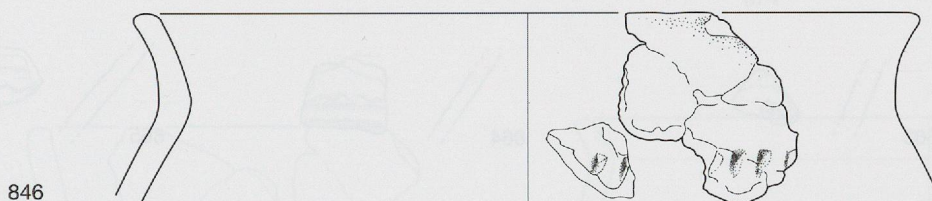

846

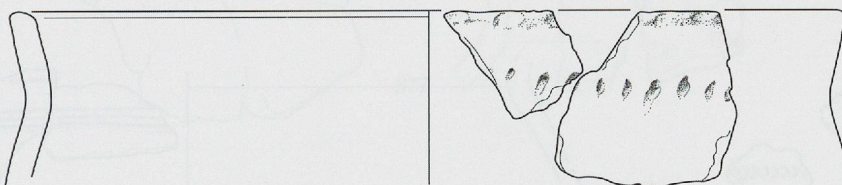

847

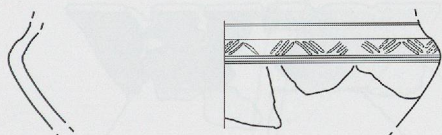

848



849



850

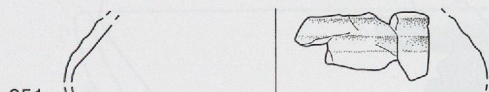

851

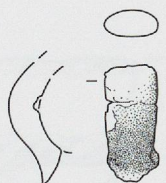

852

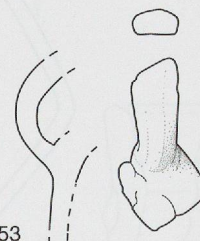

853

373

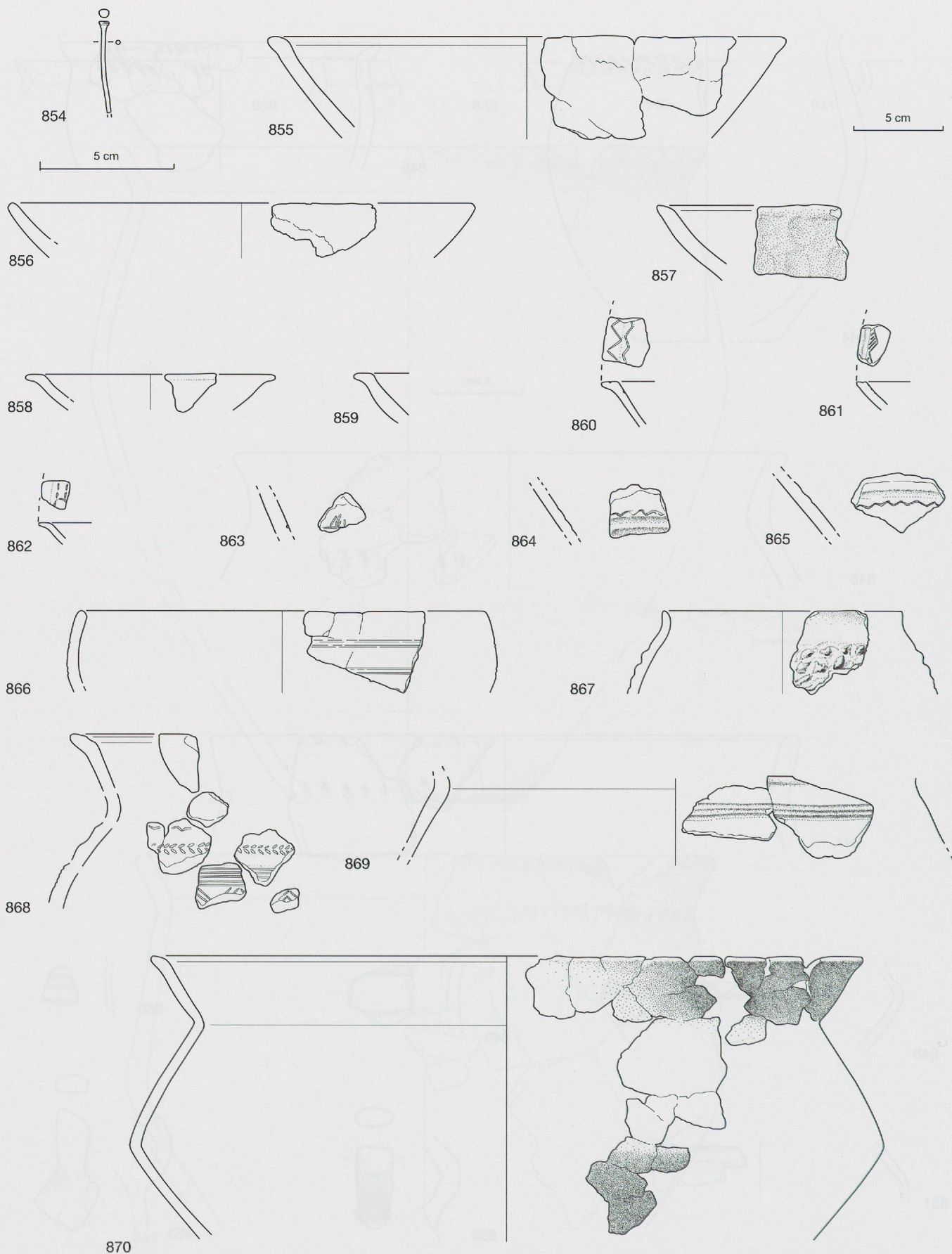

Onnens VD-Le Motti. Mobilier non stratifié. Bronze (éch. 1/2). 854: épingle. Céramique (éch. 1/3). 855-865: écuelles. 866: bol. 876-870: pots en pâte moyenne.

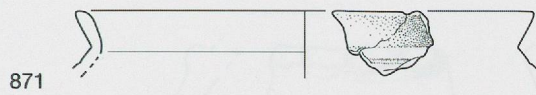

871



872

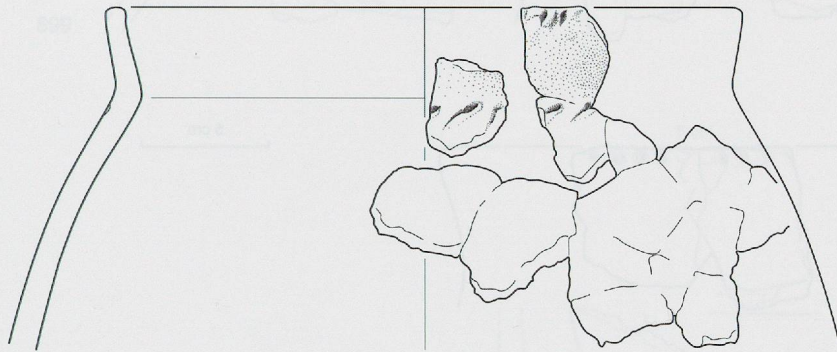

873

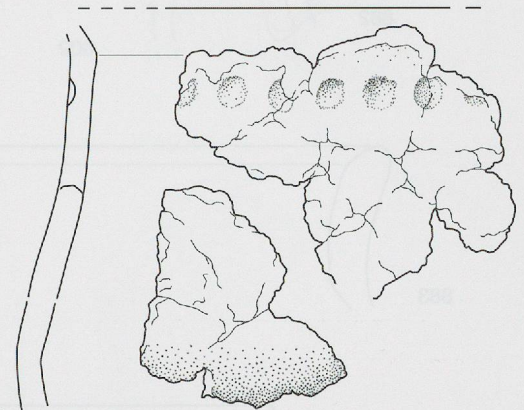

874



875



876

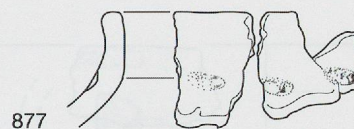

877

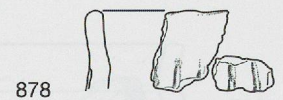

878

5 cm

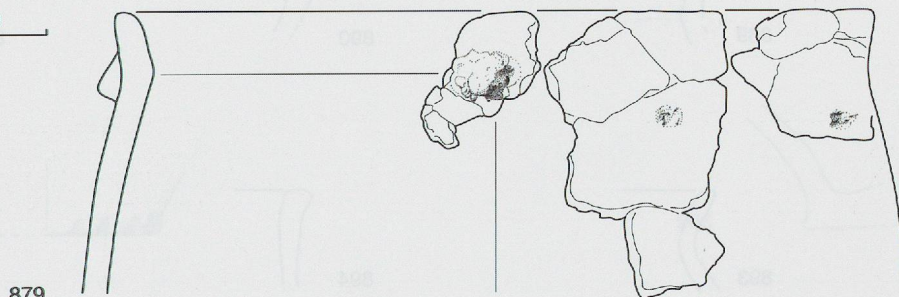

879

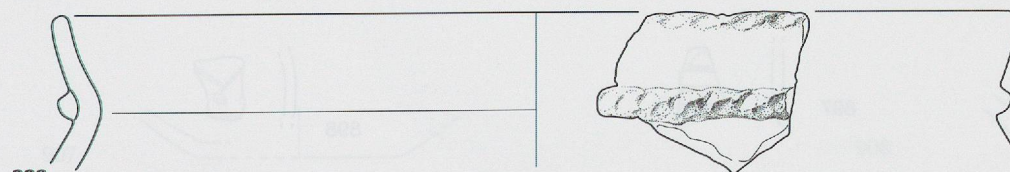

880

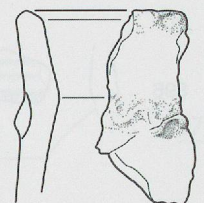

881

Onnens VD-*Le Motti* (éch. 1/3). 871-872: pots en pâte moyenne. 873-881: pots en pâte grossière.

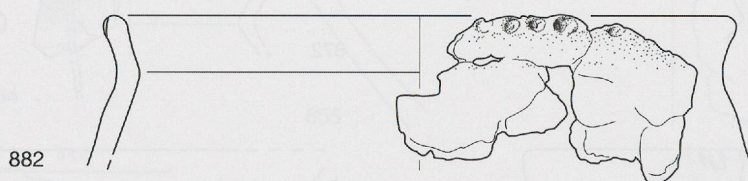

882

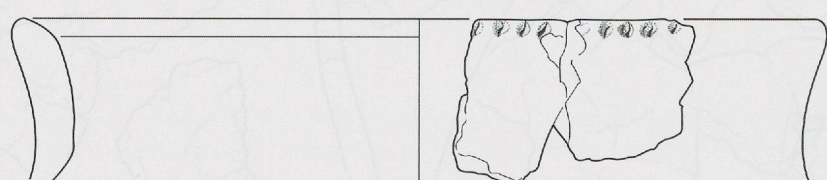

883

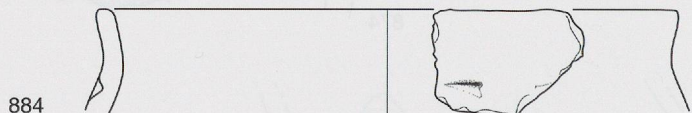
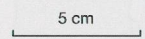

884

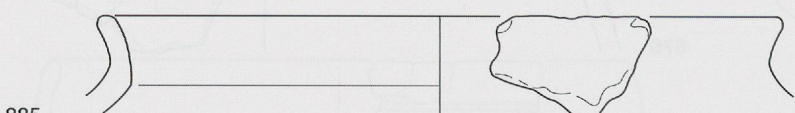

885

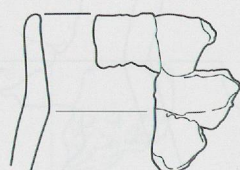

886

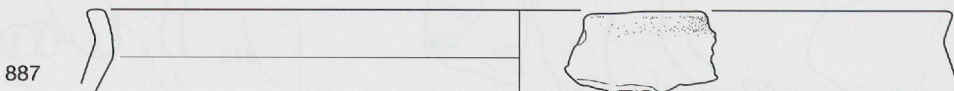

887

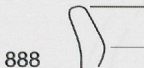

888



889



890



891

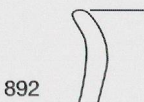

892



893

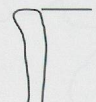

894



895

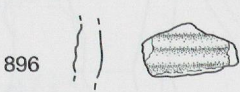

896



897



898

Onnens VD-Le Motti (éch. 1/3). 882-887: pots en pâte grossière. 888-895: bords. 896-898: panses décorées.



899

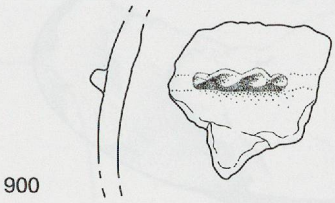

900

5 cm

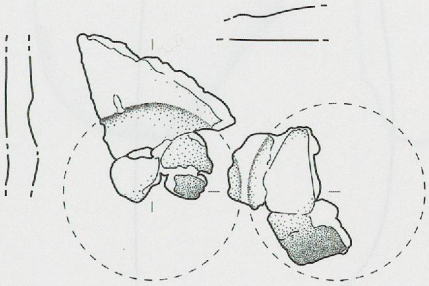

901

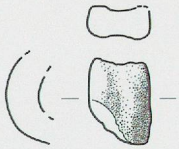

902

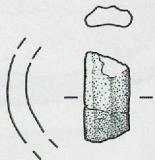

903



904



905

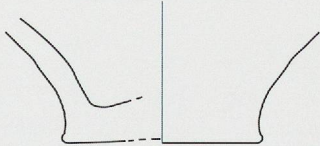

906



907



908

Onnens VD-Le Motti (éch. 1/3). 899-901: panses décorées. 902-904: anses. 905-908: fonds.

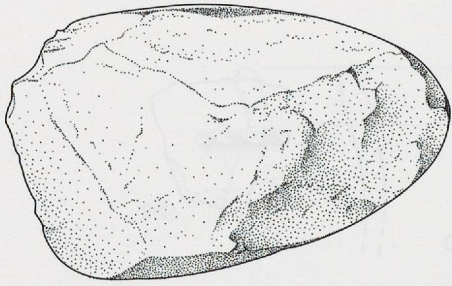

909

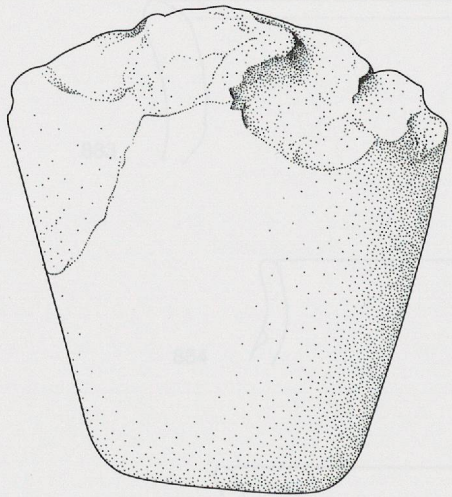

909

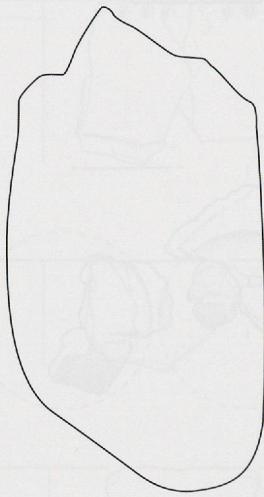

5 cm

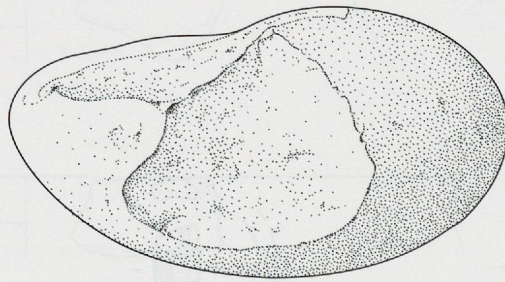

910

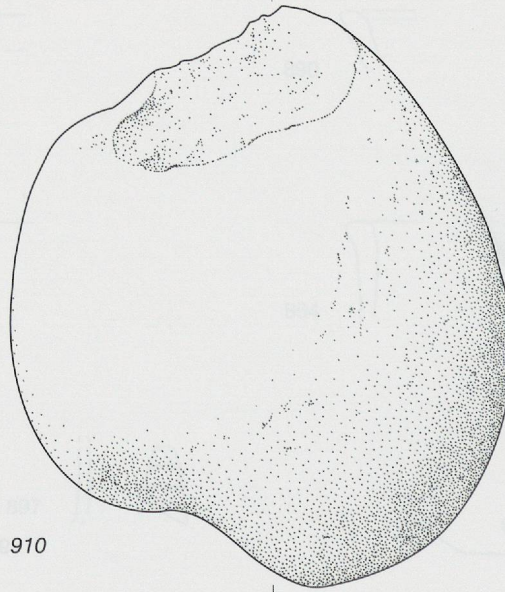

910

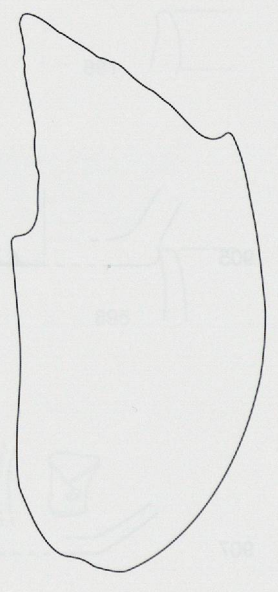

378

Onnens VD-La Golette (éch. 1/2). Pierre. 909-910: galets taillés. En italique: numéro des objets de la concentration de mobilier.

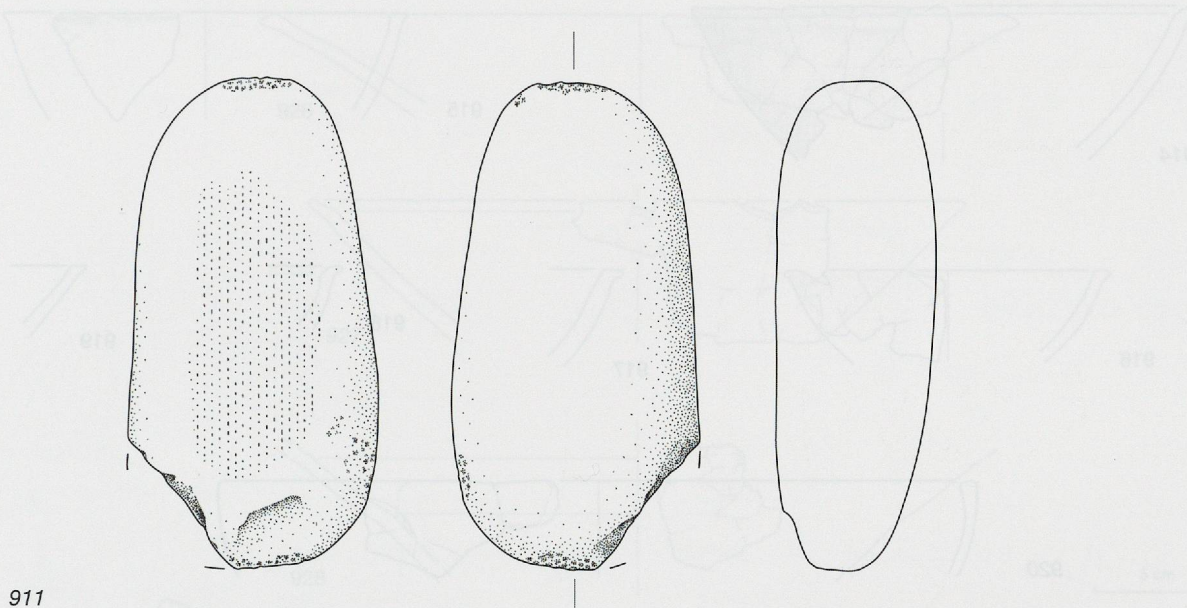

911

5 cm

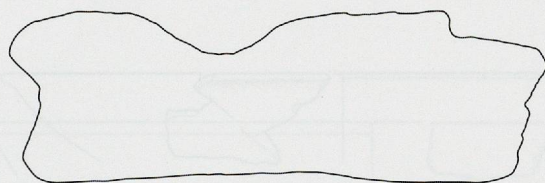

912

10 cm

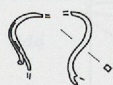

913

5 cm

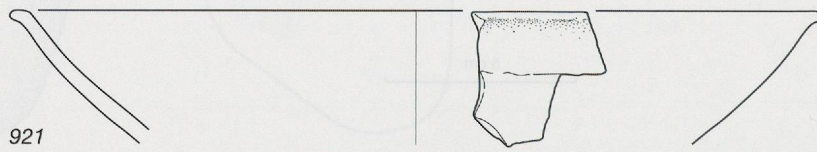
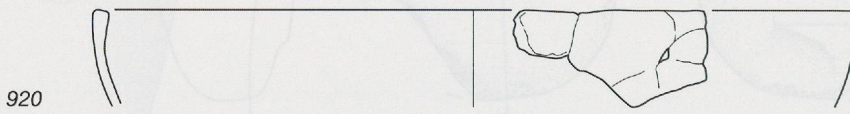
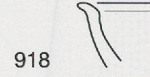
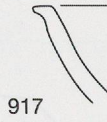
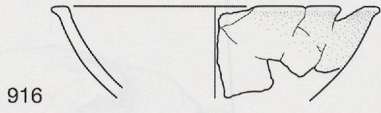
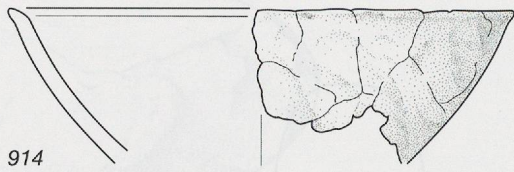

5 cm

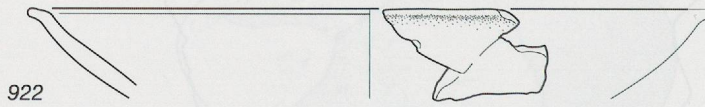

923

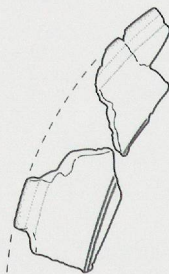
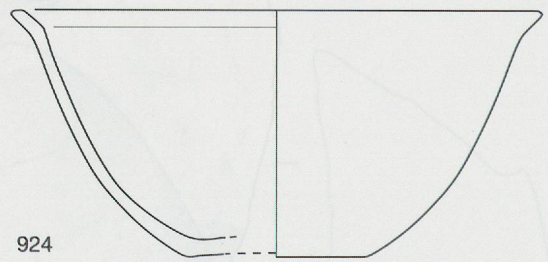
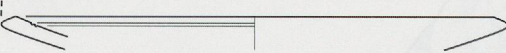

925

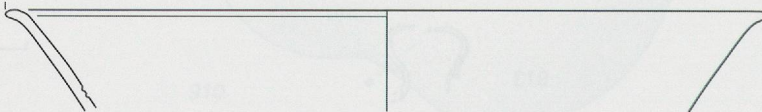

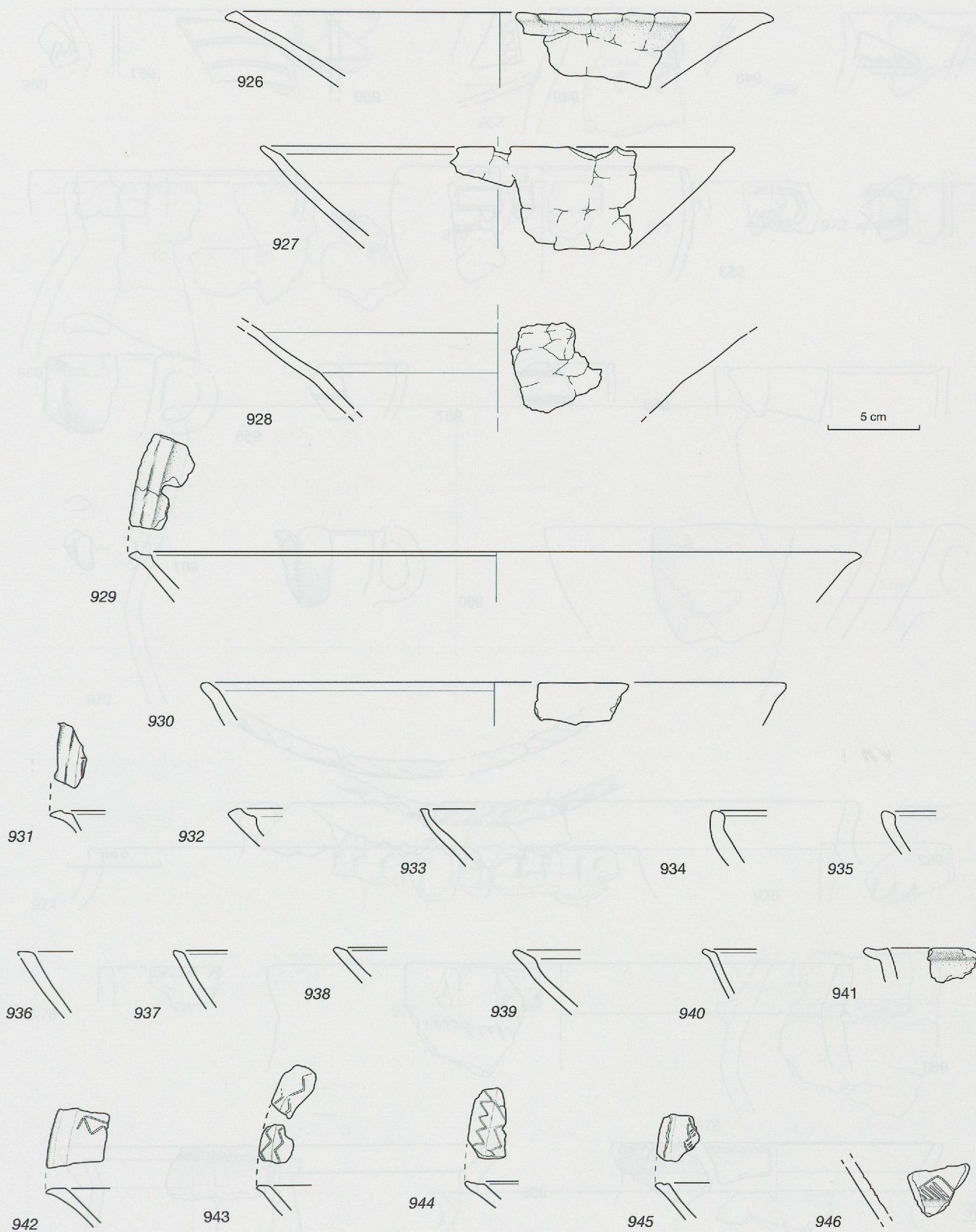

Onnens VD-La Golette (éch. 1/3). Ecuelles.

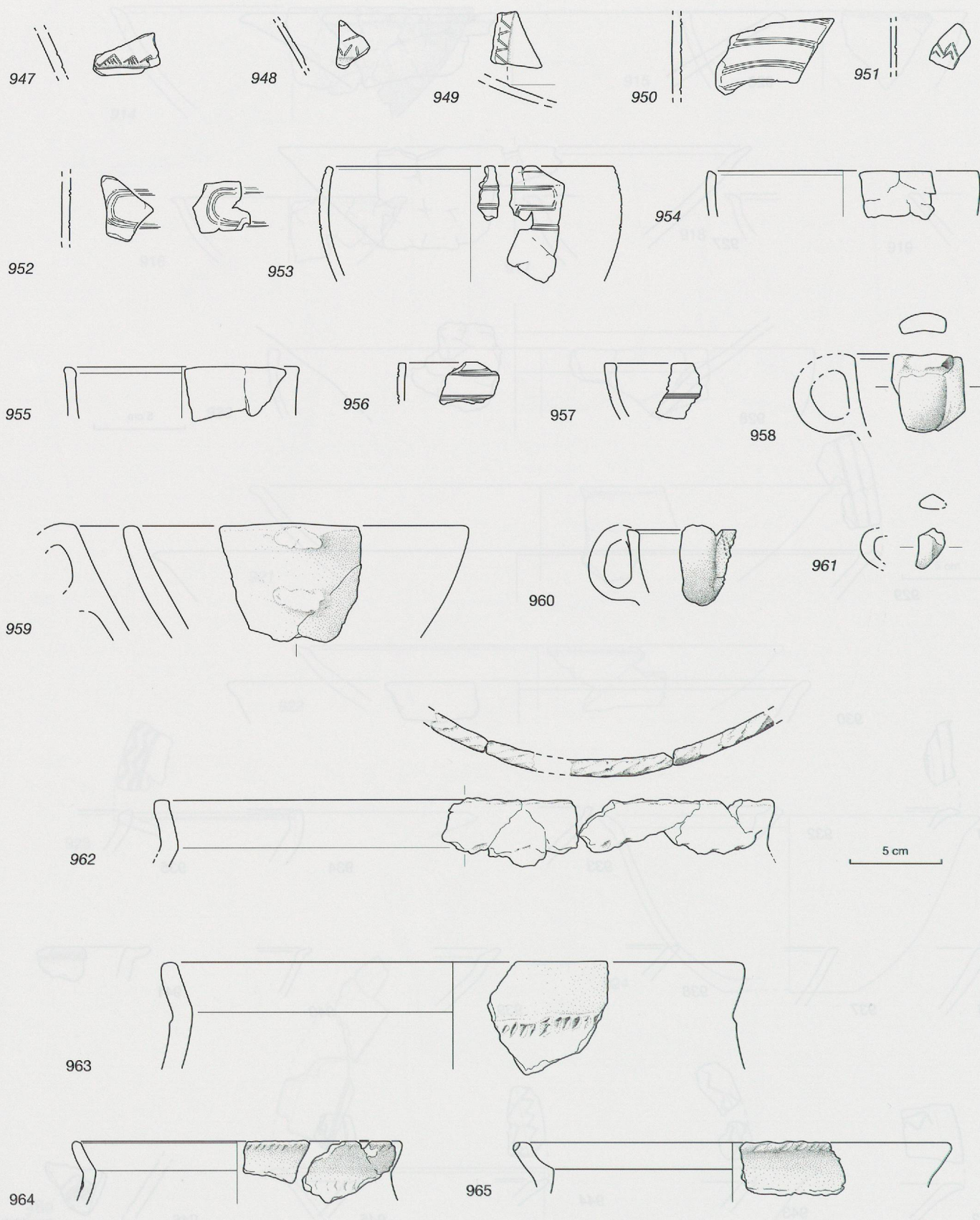

Onnens VD-La Golette (éch. 1/3). 947-952: écuellen. 953-957: bols. 958-961: tasses. 962-965: pots en pâte grossière.

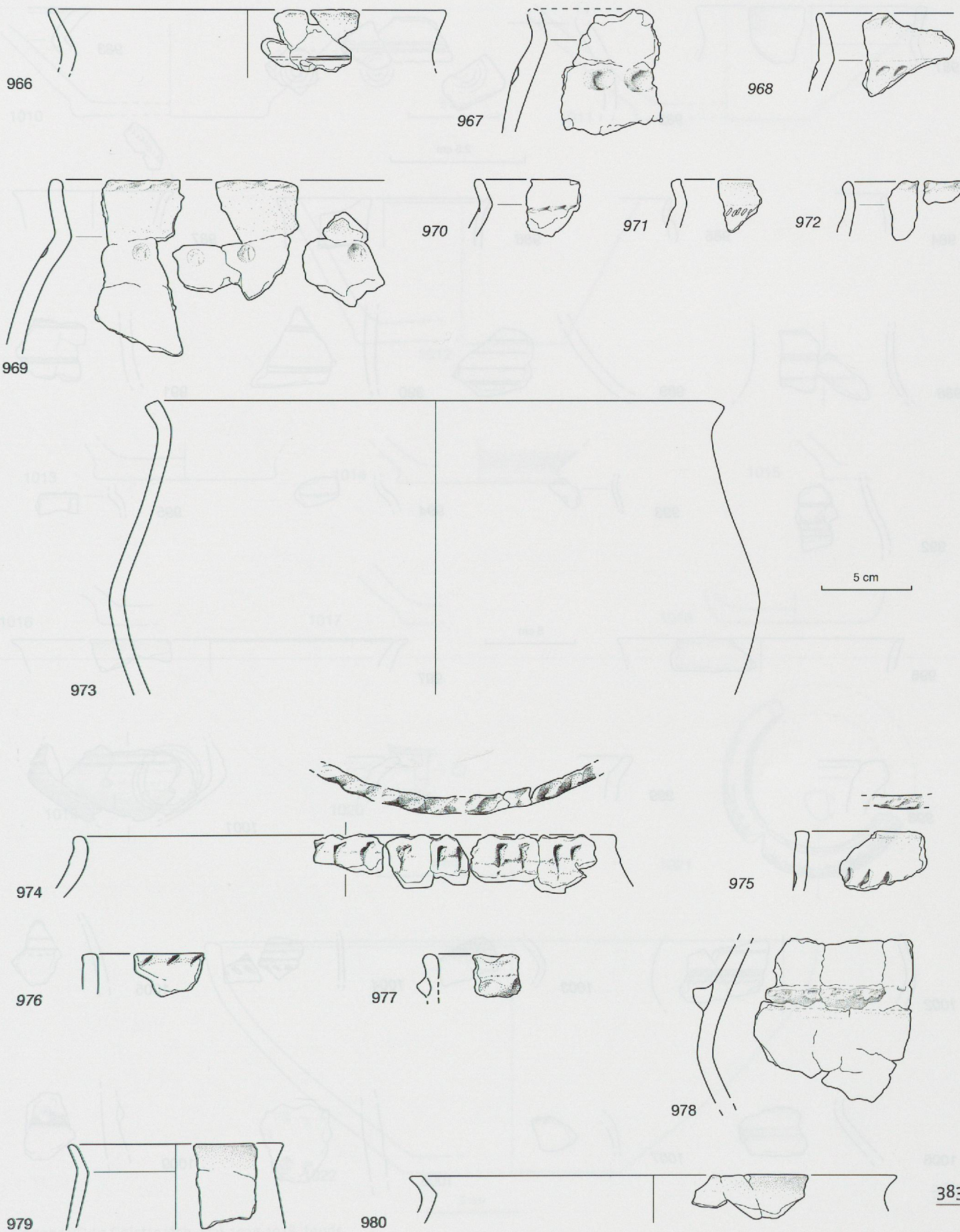

Onnens VD-La Golette (éch. 1/3). 966-978: pots en pâte grossière. 979-980: pots en pâte moyenne.

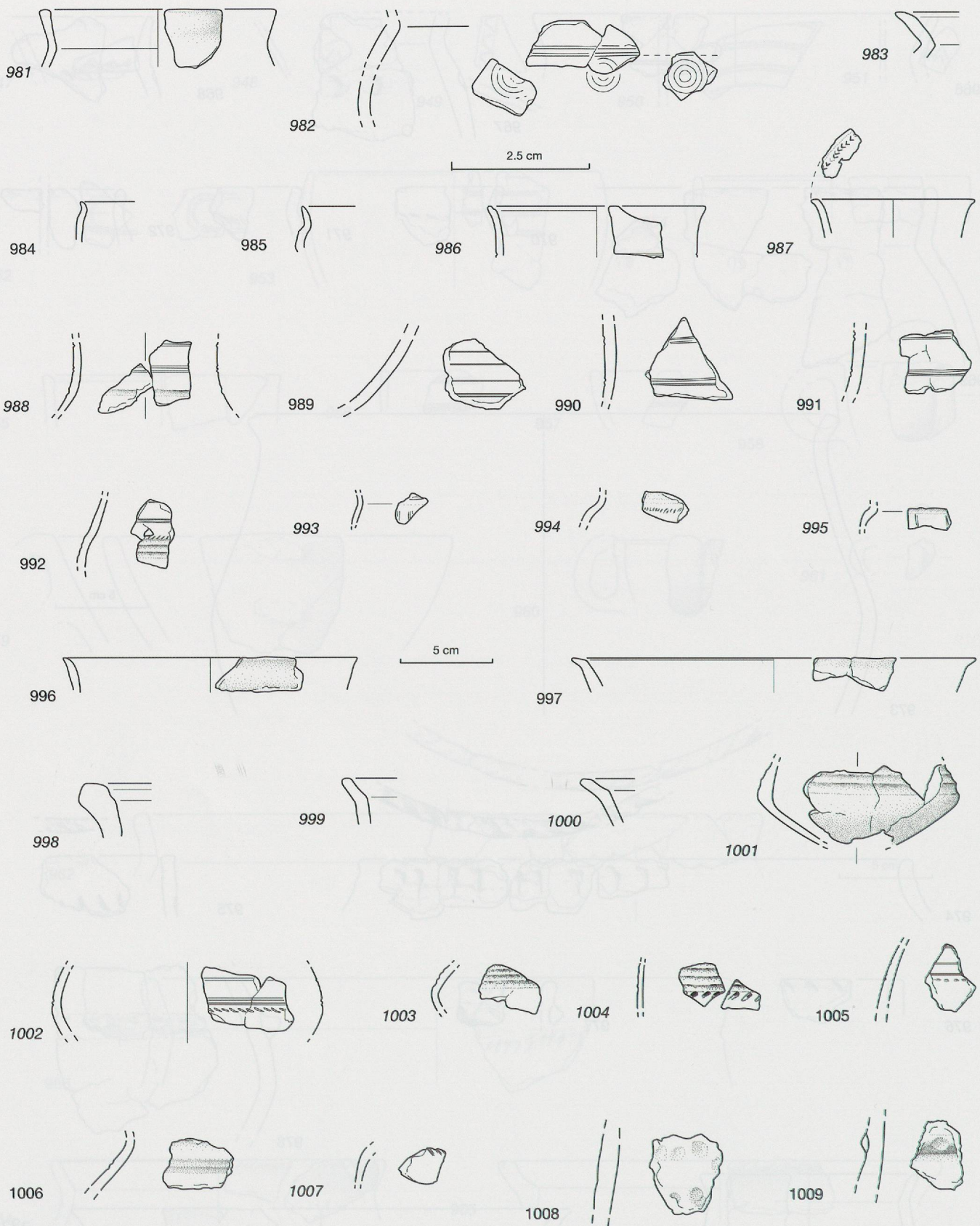

Onnens VD-La Golette (éch. 1/3 et 1/1). 981-985: pots en pâte fine ou moyenne. 986-995: gobelets à épaulement. 996-1000: bords. 1001-1009: panses décorées.

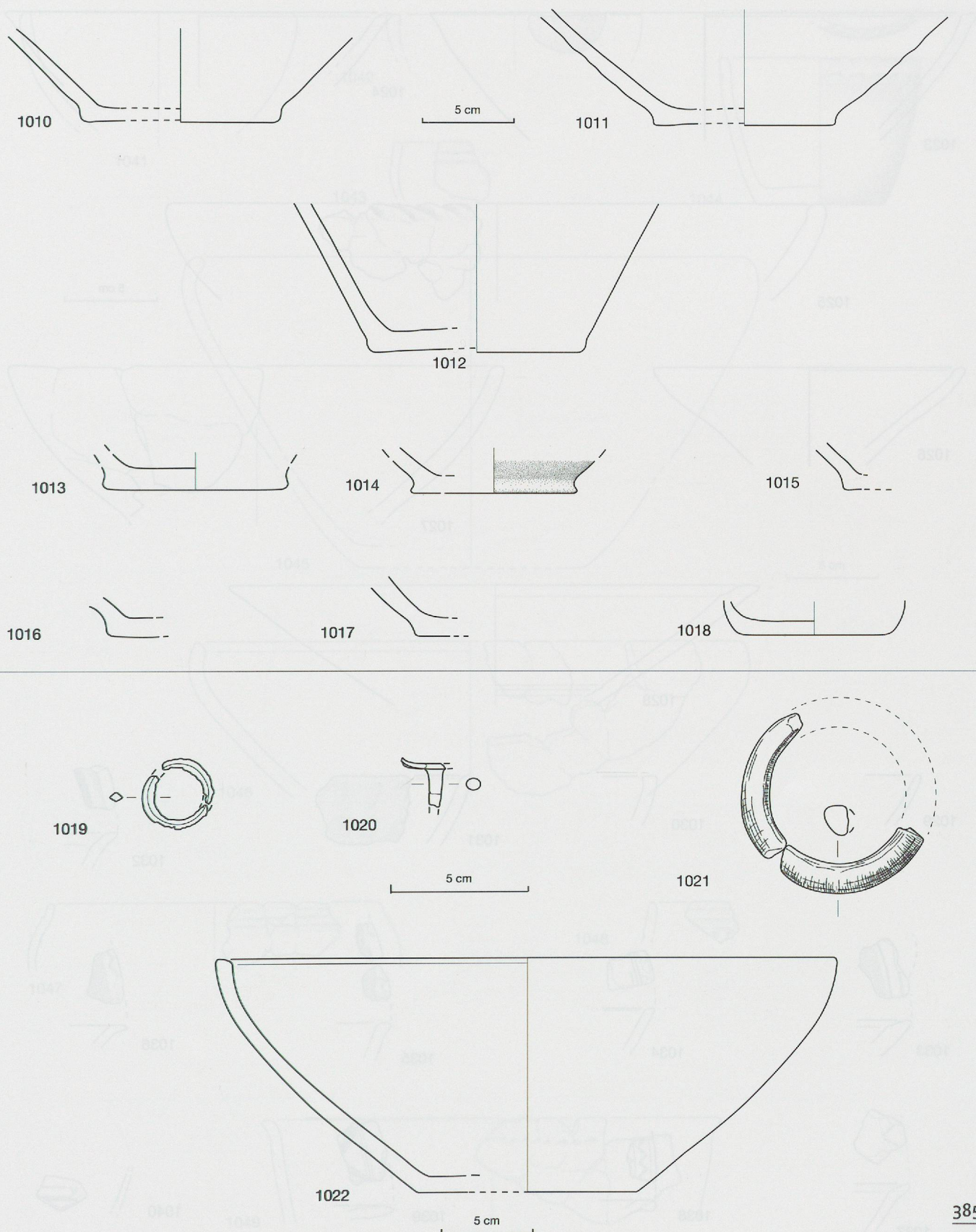

Onnens VD-La Golette (éch. 1/3). 1010-1018: fonds.
 Onnens VD-Beau Site. Bronze (éch. 1/2). 1019: anneau. 1020: épingle. Schiste bitumineux (éch. 1/2). 1021: bracelet.
 Céramique (éch. 1/3). 1022: écuelle.

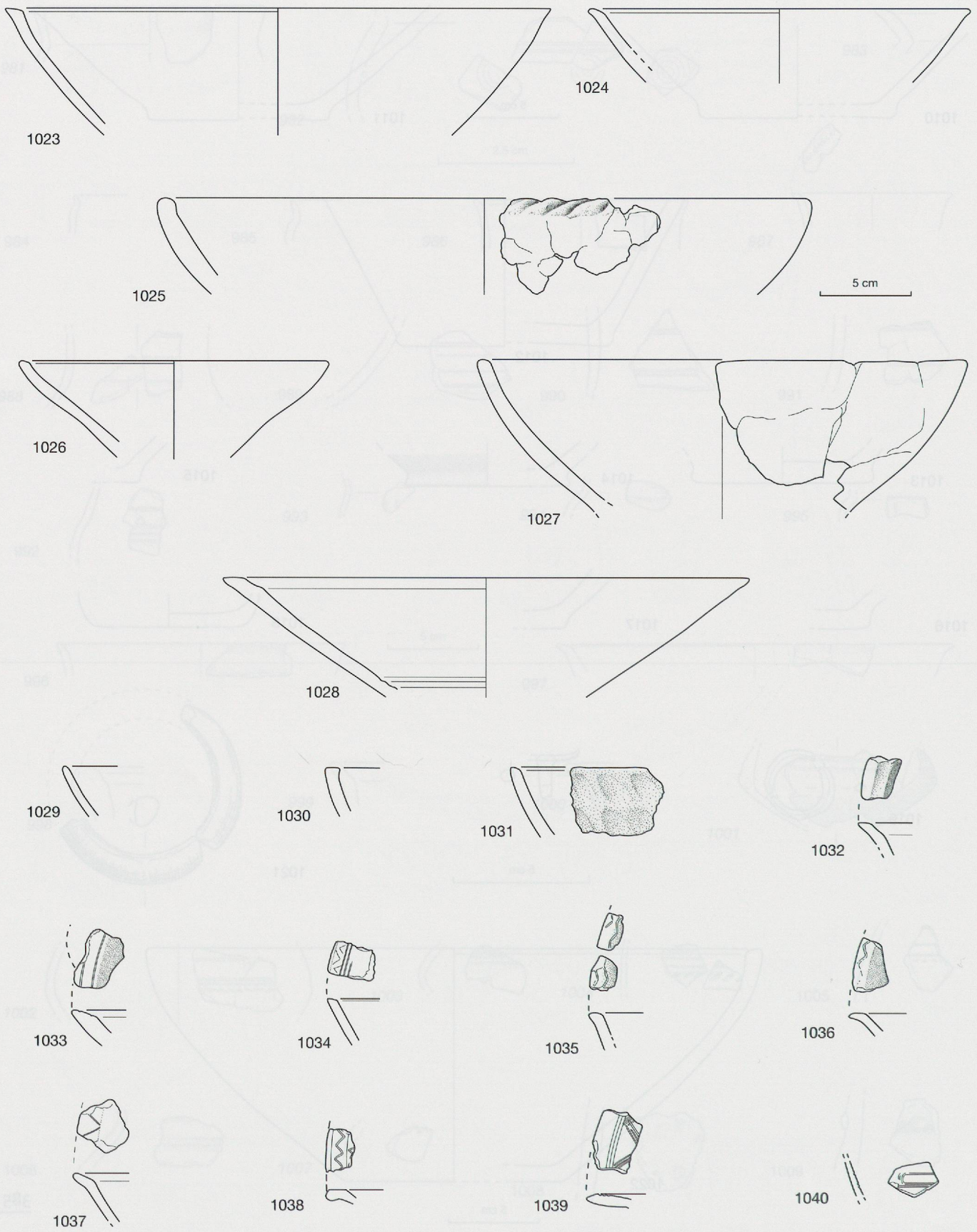

Onnens VD-Beau Site (éch. 1/3). 1023-1040 : écuelles.

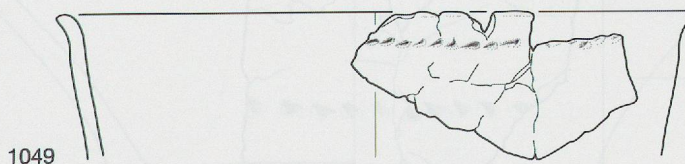
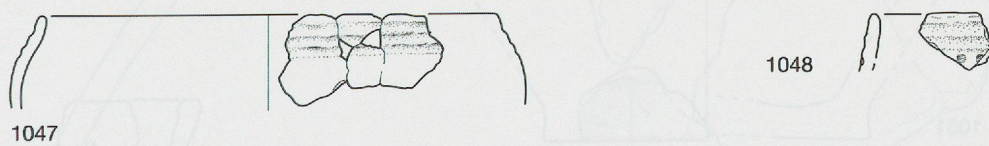
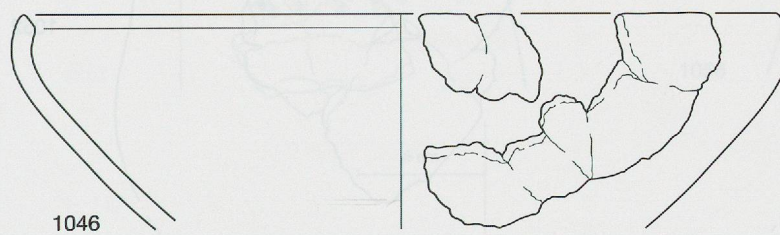
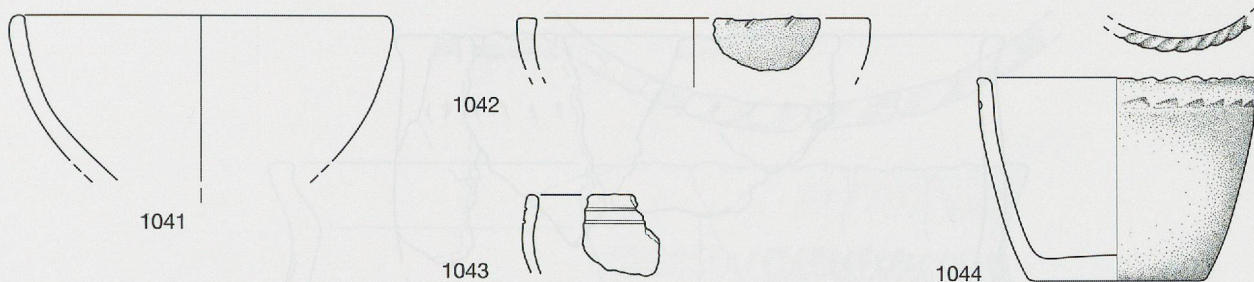

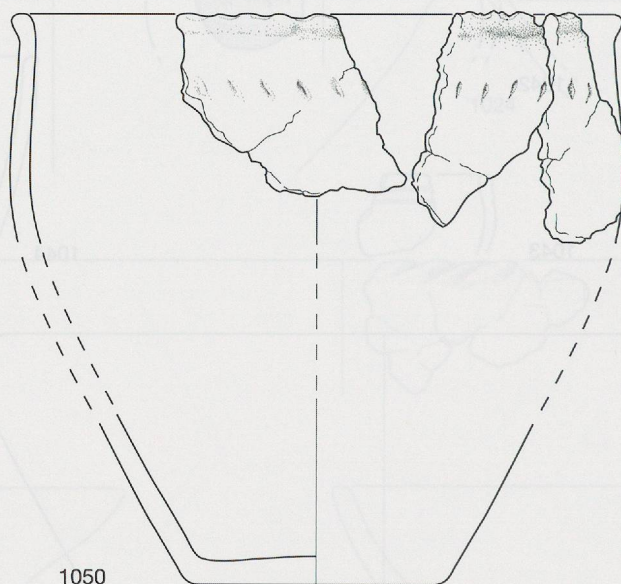

5 cm

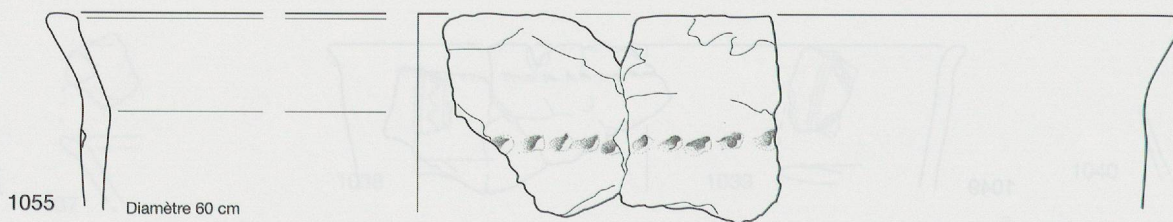
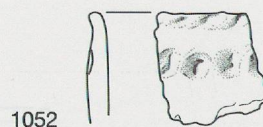
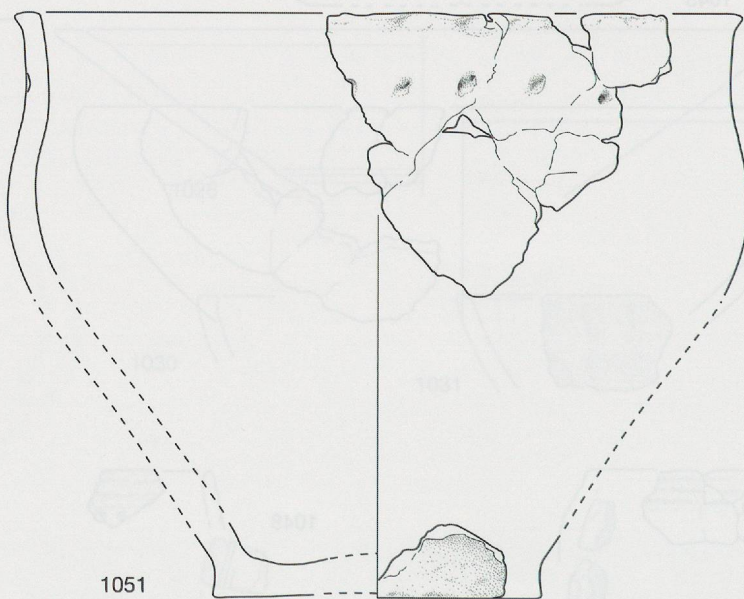

Diamètre 60 cm

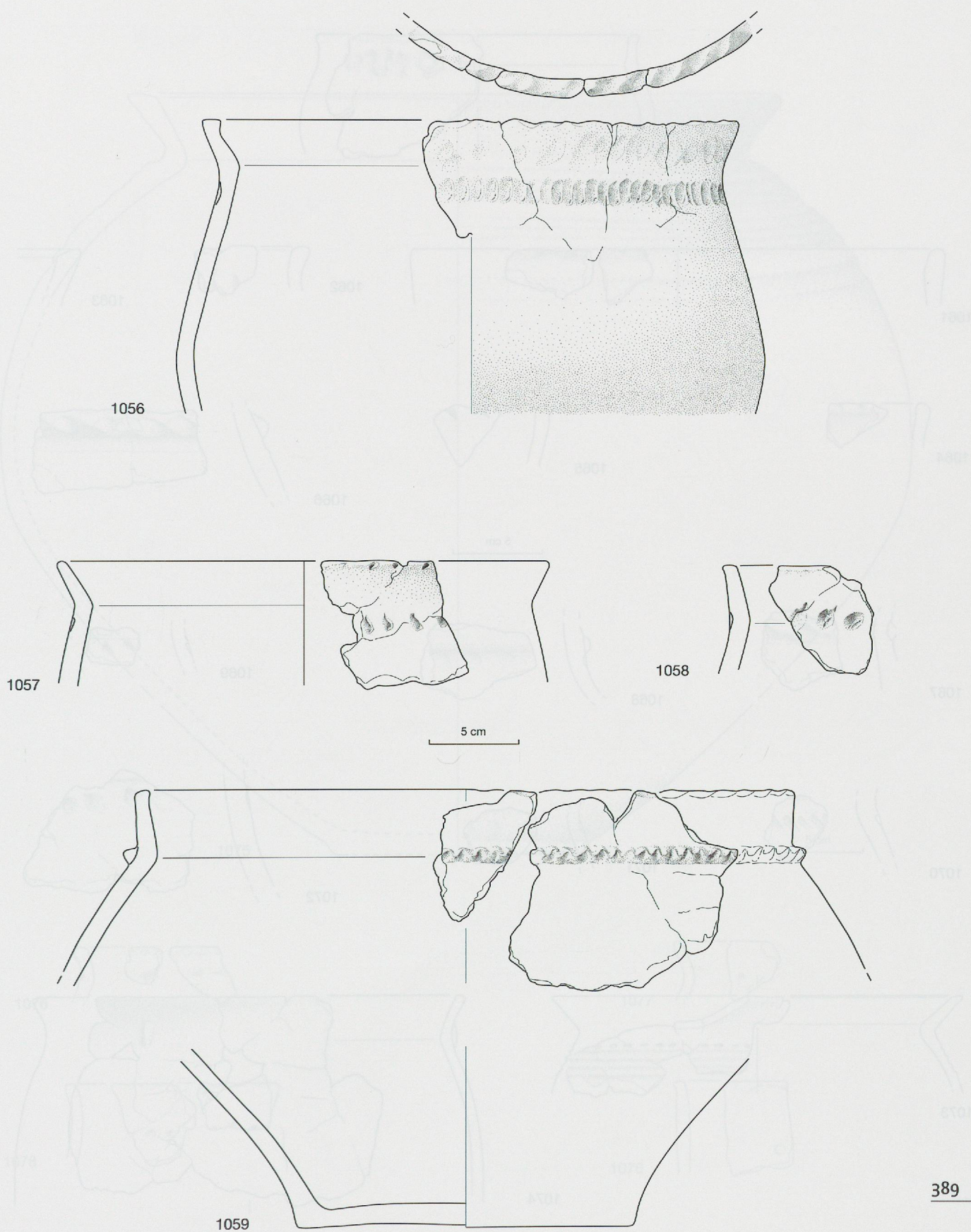

Onnens VD-Beau Site (éch. 1/3). Pots en pâte grossière.

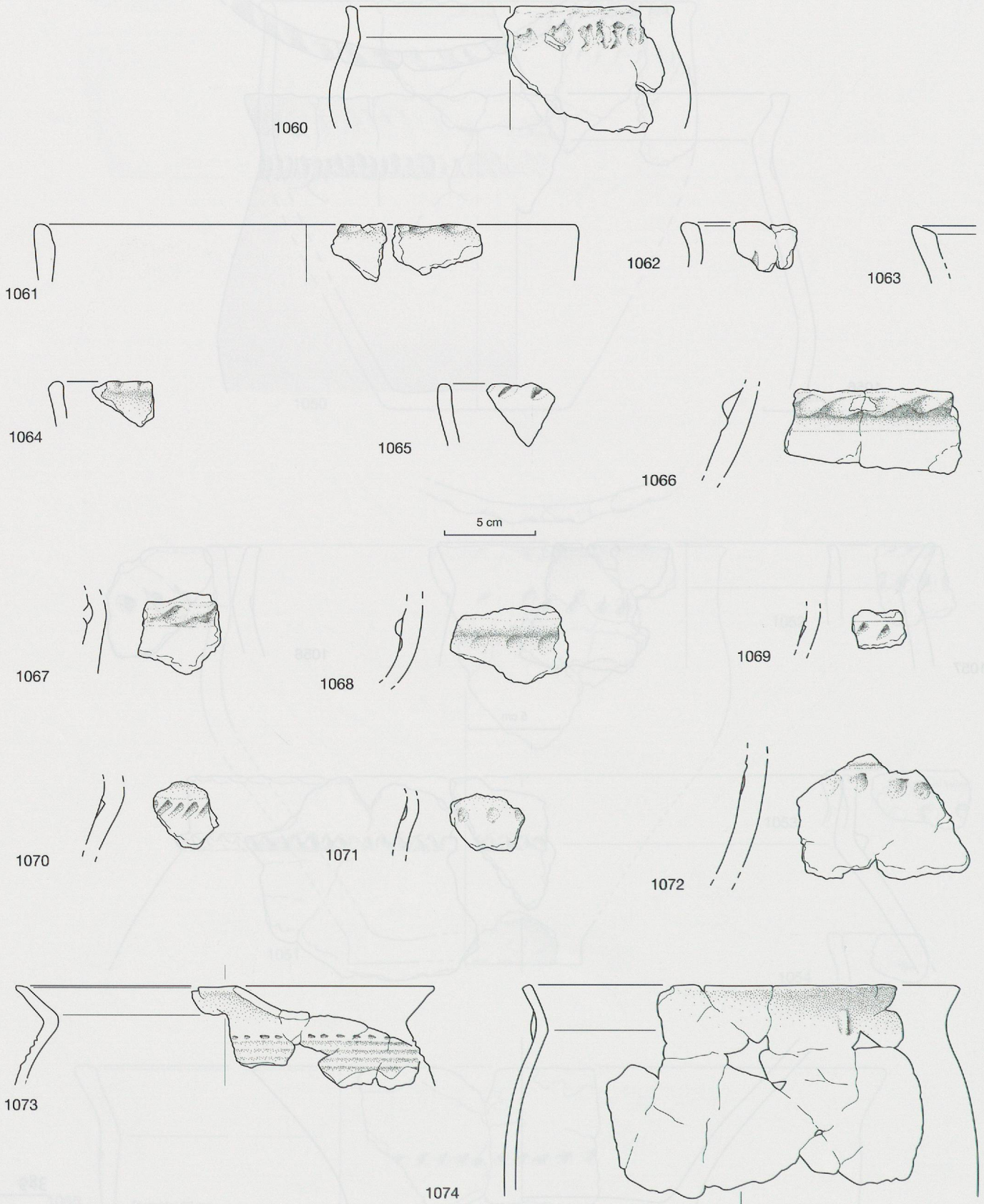

Onnens VD-Beau Site (éch. 1/3). 1060-1072: pots en pâte grossière. 1073-1074: pots en pâte moyenne.

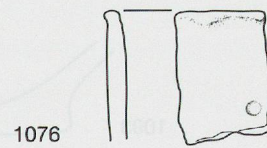
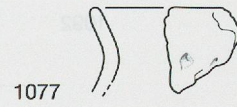
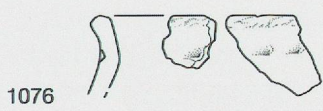
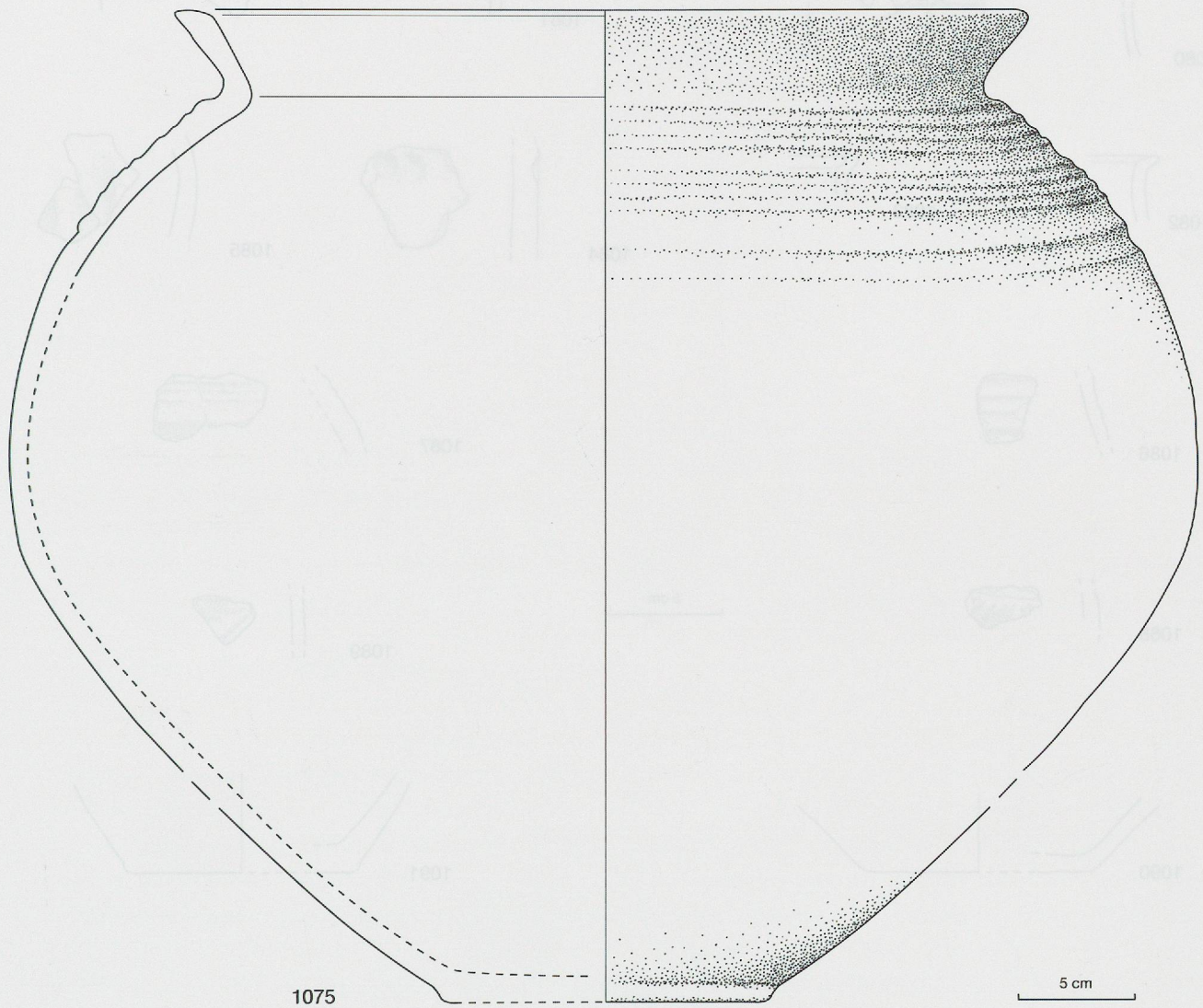

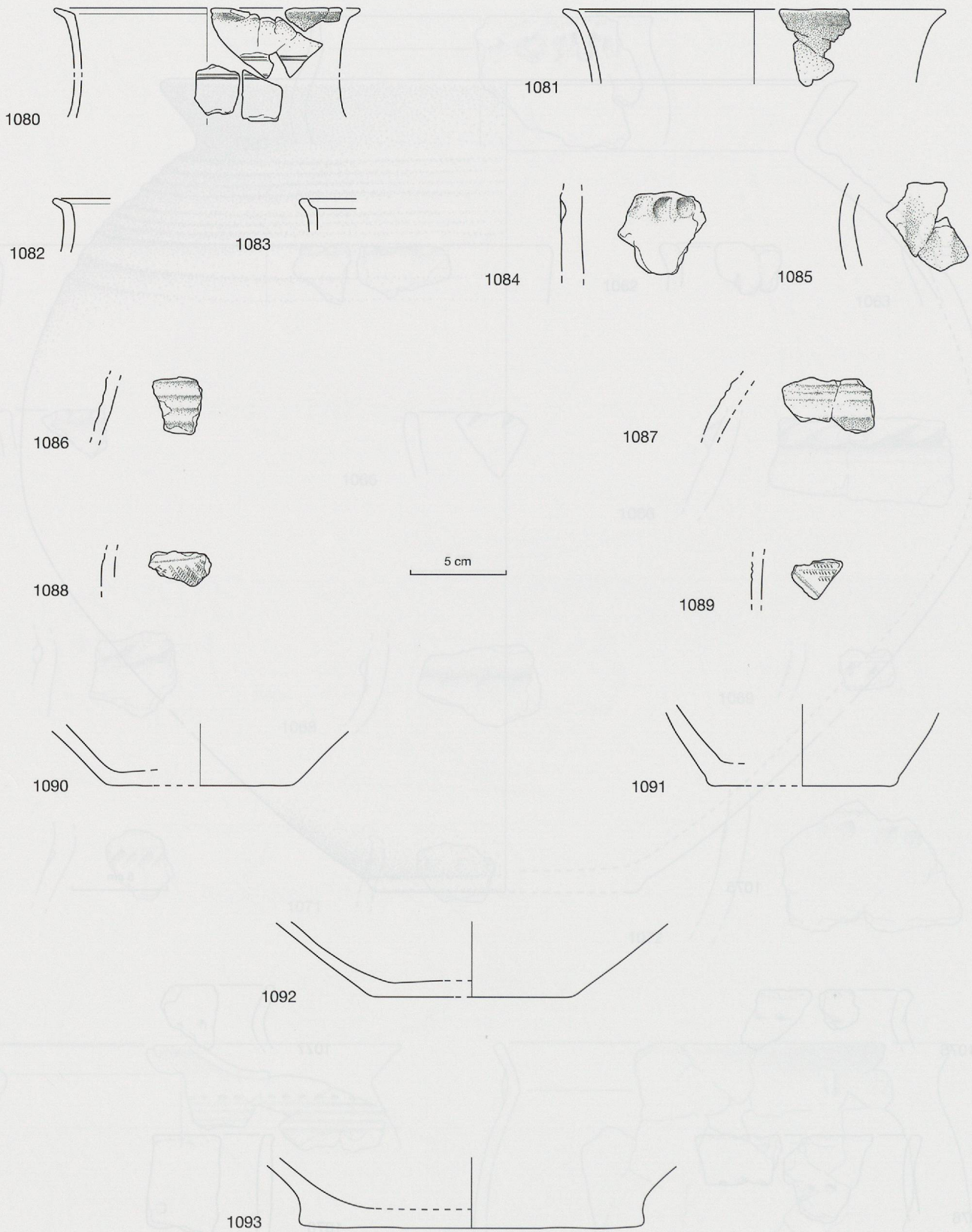

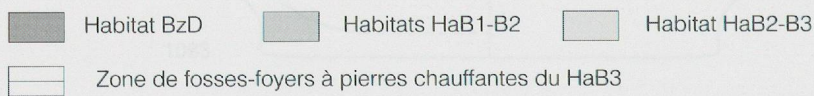
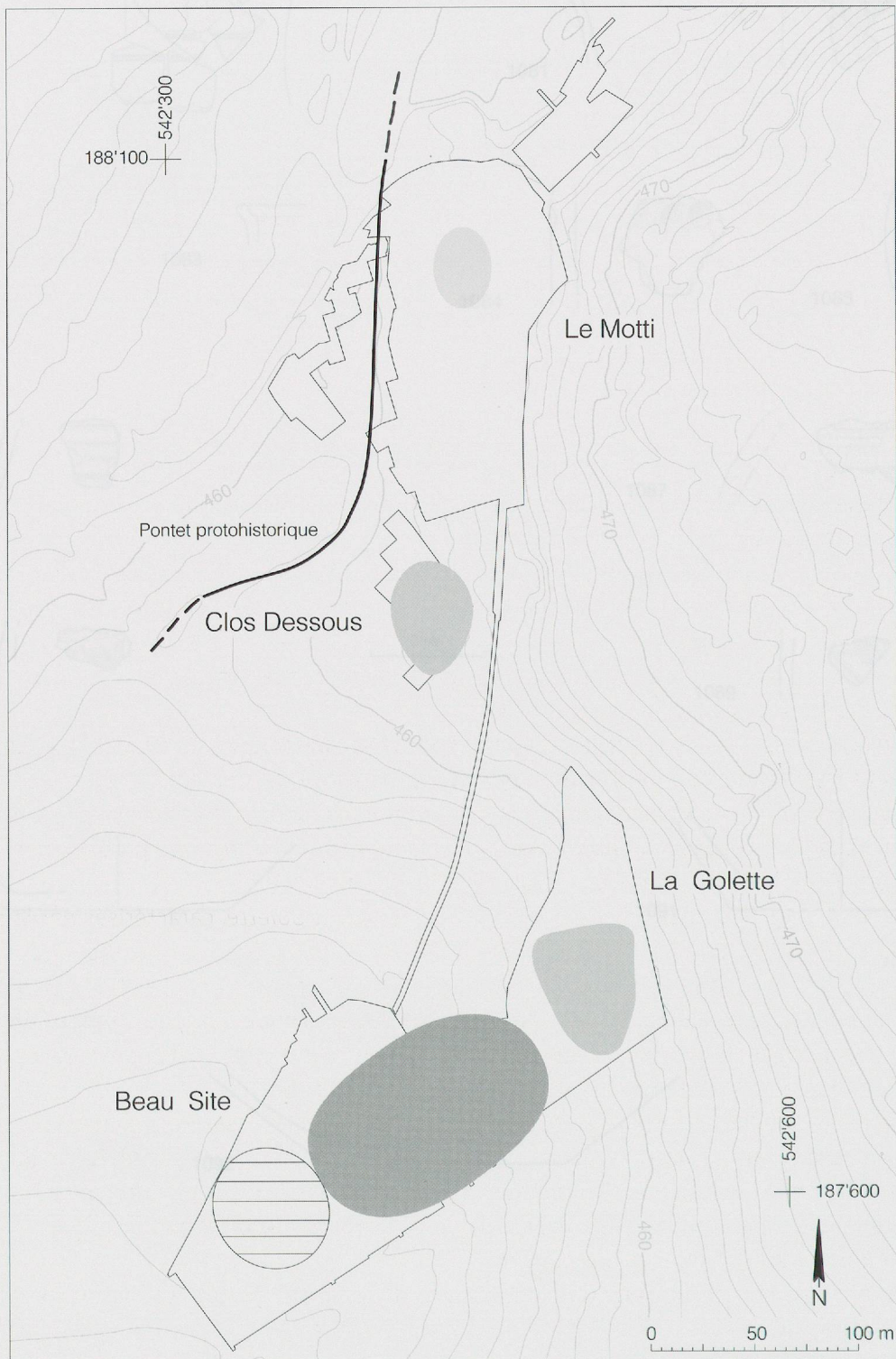

Fig. 264. Evolution de l'occupation sur les versants sud et ouest de la colline d'Onnens durant le Bronze final. Habitats du BzD (en gris foncé), du HaB1-B2 (en gris moyen) et du HaB2-B3 (en gris clair); zones de fosses-foyer à pierres chauffantes du HaB3 (en hachuré).