

The influence of hydraulic forces on the selection of structural form

Autor(en): **Glerum, A. / Schippers, J.**

Objektyp: **Article**

Zeitschrift: **IABSE reports of the working commissions = Rapports des commissions de travail AIPC = IVBH Berichte der Arbeitskommissionen**

Band (Jahr): **36 (1981)**

PDF erstellt am: **24.09.2024**

Persistenter Link: <https://doi.org/10.5169/seals-28268>

Nutzungsbedingungen

Die ETH-Bibliothek ist Anbieterin der digitalisierten Zeitschriften. Sie besitzt keine Urheberrechte an den Inhalten der Zeitschriften. Die Rechte liegen in der Regel bei den Herausgebern.

Die auf der Plattform e-periodica veröffentlichten Dokumente stehen für nicht-kommerzielle Zwecke in Lehre und Forschung sowie für die private Nutzung frei zur Verfügung. Einzelne Dateien oder Ausdrucke aus diesem Angebot können zusammen mit diesen Nutzungsbedingungen und den korrekten Herkunftsbezeichnungen weitergegeben werden.

Das Veröffentlichen von Bildern in Print- und Online-Publikationen ist nur mit vorheriger Genehmigung der Rechteinhaber erlaubt. Die systematische Speicherung von Teilen des elektronischen Angebots auf anderen Servern bedarf ebenfalls des schriftlichen Einverständnisses der Rechteinhaber.

Haftungsausschluss

Alle Angaben erfolgen ohne Gewähr für Vollständigkeit oder Richtigkeit. Es wird keine Haftung übernommen für Schäden durch die Verwendung von Informationen aus diesem Online-Angebot oder durch das Fehlen von Informationen. Dies gilt auch für Inhalte Dritter, die über dieses Angebot zugänglich sind.



I

The influence of hydraulic forces on the selection of structural form

L'influence des forces hydrauliques sur le choix du système et de la forme d'une structure

Einfluss hydromechanischer Kräfte auf die Wahl des Systems und der Form eines Tragwerks

A. GLERUM

prof. ir.
Delft University of Technology
Delft, The Netherlands

J. SCHIPPERS

ir.
Delft University of Technology
Delft, The Netherlands

SUMMARY

Besides that the hydraulic forces have an influence on the structure, the shape of the structure may often influence the hydraulic loads as well. A distinction should be made between hydrostatic forces which are for instance caused by a difference in head between two water levels and dynamic forces as e.g. loads resulting from the energy in waves. We give some examples of the structures which are mainly subject to hydrostatic loading. Recommendations have been discussed in order to reduce wave forces and are followed by examples.

RESUME

Les forces hydrauliques agissent sur une structure. Mais la forme d'une structure peut aussi influencer ces forces hydrauliques. Les forces hydrostatiques peuvent être causées, par exemple, par une différence de hauteur de deux niveaux d'eau et les forces dynamiques peuvent être dues à l'énergie de la houle. Des exemples de structures surtout soumises à des charges statiques sont présentés. Des recommandations sont proposées afin de réduire les forces dues à la houle et sont illustrées par quelques exemples.

ZUSAMMENFASSUNG

Hydromechanische Kräfte beeinflussen ein Tragwerk, aber durch die Form eines Tragwerks können diese hydromechanischen Kräfte beeinflusst werden. Man unterscheidet zwischen hydrostatischen Kräften, die z.B. durch zwei unterschiedlich hohe Wasserspiegel entstehen, und hydrodynamischen Kräften, die durch Wellen verursacht werden. Als Beispiele werden Tragwerke besprochen, die hauptsächlich durch hydrostatische Kräfte beansprucht werden. Es werden ausserdem Empfehlungen zur Reduktion der hydrodynamischen Kräfte gegeben und einige Beispiele dazu präsentiert.



1. INTRODUCTION

The designer of hydraulic structures is confronted with a large variety of loads originating from different sources. It is his task to give the structure such a shape, so that these loads are obviously transferred to the subsoil and in an economical way. A complication is that the shape may influence the hydraulic loads and vice versa, which can be an advantage. This is an impediment to a more systematic treatment of the influence of hydraulic forces in selecting structural shapes.

For this reason the paper will deal with the subject as follows.

First of all a survey will be given of the hydraulic forces involved, making a distinction between static and dynamic forces. A few examples of structures which are mainly subject to static loading will be described. Then some topics on wave action will be discussed and some general recommendations to reduce wave loads on structures will be given, followed by a few examples.

Finally wave power installations will be described as an example of the reverse principle, viz. not the dissipation but the accumulation of wave energy.

2. HYDRAULIC FORCES

Hydraulic forces can be distinguished in static and dynamic loads.

To the hydrostatic loads belong:

- a. A difference in head as is e.g. the case with a weir, which is made to separate two different water levels. Differences in head may also arise due to long waves such as surges and translation waves.
- b. All-sided water pressures which act on submerged structures as e.g. a sub-aqueous tunnel.
- c. Flow induced stationary forces (drag forces on bridge piers etc.).

Dynamic loads can be divided into:

- a. Standing wave loads resulting from in time and depth changing pressures on a structure (storm surge barriers etc.).
- b. Wave forces consisting of inertia and drag forces (acting on legs of offshore platforms etc.).
- c. Wave impacts caused by waves that strike the surfaces of the structures (storm surge barriers, breakwaters etc.).

It should be noted that the first two loads have a semi-static character, whereas the last one is really dynamic, happening within parts of a second.

3. STRUCTURES LOADED BY HYDROSTATIC FORCE

a. Difference in head

The external hydrostatic forces develop internal stresses in the structure which transmits the external load together with the dead weight to the subsoil. The shape of a fixed weir e.g. is defined by a vertical wall with a certain width at the bottom to transmit the bending moments, shear and normal forces to the footing and by a width of the floorslab in accordance with the bearing capacity of the subsoil (both

horizontally and vertically). If the hydraulic loads are large and the external horizontal stability is not ensured this can be ascertained by increasing the dimensions of the structure (increased dead weight and friction).

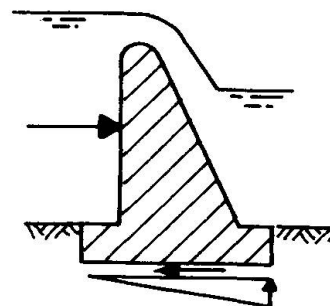

FIXED WEIR



The shape of a tension curve in steel or a pressure curve in concrete gives the possibility to optimise the use of the construction material, where a uniform load occurs due to e.g. hydraulic head. This principle for instance has been applied at the semi-circular gates of the movable weirs in the Lower Rhine [1]. A complication is the connection of the steel gate to the concrete structure. The free outflow of the undershot must consequently be possible near the piers and abutments, otherwise the blockage of flow would build up pressures, which endanger the equal load distribution on which the gate design has been based.

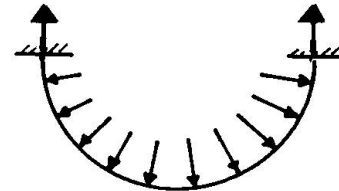
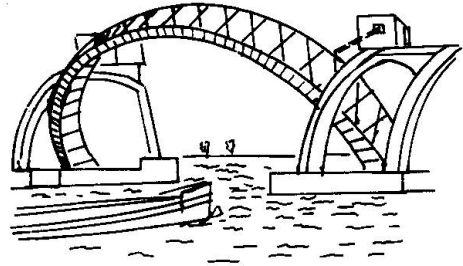

MOVABLE WEIR

If the pressure head is very large as e.g. in a deep valley, a concrete arch dam can carry the hydraulic force horizontally to the subsoil. It has the shape of a pressure curve and spans between the side slopes of the valley.

The circular shape can also be seen in a certain type of lock-gate as the sector gate with vertical axis. Due to the circular shape and the fact that the waterpressure always acts perpendicular to the surface, the resulting horizontal load runs through the rotation axis.

Therefore, the forces on the operational equipment are lower and also the required power when the gate must be opened under a head or closed during a flow, than in the case of e.g. mitre gates.

The rising sector gate, which is more used and sometimes called segment gate or taintor gate, has the same advantages as the above mentioned sector gate.

In order to avoid vibrations as much as possible during the raising of the gates it is important to place the rotation axis exactly in the centre of the steel plating.

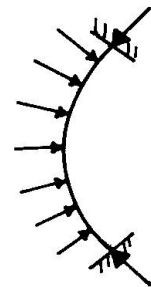

ARCH DAM

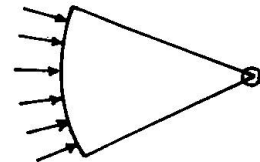

SECTOR GATE

Above a few examples have been described of how to reduce the construction material or the required power of the operational equipment by applying circular shapes. It should be stressed however, that this shape is generally more labour consuming than a simple flat structure, or occupies a large space. For that reason flat structures often lead to more economical solutions, especially in countries where the labour cost are high.

b. All-sided water pressure

The circular cross-section proves to be the best shape in case of all-sided water pressure as e.g. for tunnels which are crossing waterways and for piping under the influence of ground water, as this gives minimum bending



moments.

Where this principle is abandoned for other reasons, it sometimes shows its influence in the cross-section as is shown in the figure of the 2-track metro tunnel in Rotterdam (immersed type built in concrete). Although the curved shape is preferable from the load bearing point of view, it is often abandoned in immersed tunnel design because it can lead to superfluous space around the generally rectangular traffic gauge (free width x free height). Therefore this can lead to a greater length of the tunnel, because the road surface or the rail tracks are situated at a greater depth below the river bottom than in a rectangular structure [2]. This results in higher cost and that's why most immersed tunnels in the Netherlands and in many other countries have a rectangular shape.

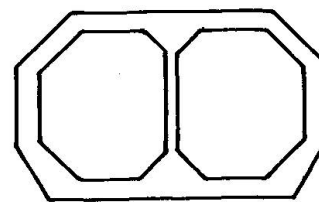

RAILWAY-TUNNEL

c. Forces by constant flow

To minimise flow induced forces as e.g. on a bridge pier in a river it is preferable to round the edges of the structure. In this way the drag force acting on the pier can be reduced considerably as is shown in the figure

$$F = C_d \frac{1}{2} \rho A u^2 \quad \text{in which}$$

$$F = \text{drag force (N)}$$

$$C_d = \text{drag coefficient (-)}$$

$$\rho = \text{density of water (kg/m}^3\text{)}$$

$$A = \text{pier area perpendicular to the direction of the flow (m}^2\text{)}$$

$$u = \text{undisturbed flow velocity (m/s)}$$

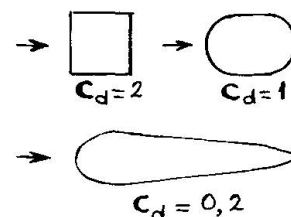

Generally the drag force is small compared with the other loads acting on the pier, but the streamlined shape has a favourable effect on the flow as well, increasing the discharge coefficient of the remaining cross sectional area of the river.

It should be added that the flow may cause a force perpendicular to the drag force as well, viz. the lift force which can have an alternating character.

4. CHARACTERISATION OF A WAVE-FIELD AND THE TRANSFER TO DESIGN LOADS

The wave loads acting on a structure can be described as follows:

$$S_w(f) = O^2(f) \times S_\eta(f)$$

in which

$$S_w(f) = \text{spectral density of wave loads (load spectrum)}$$

$$O(f) = \text{transfer function; the waves are assumed to be long crested and perpendicular to the structure}$$

$$S_\eta(f) = \text{spectral density of incoming waves (wave spectrum)}$$

$$f = \text{frequency}$$

It is obvious that the shape of the wave spectrum and the transfer

function determines the shape of the load spectrum. Figure A gives an example of a wave spectrum in the sea delta in the south of the Netherlands.

The wave spectrum is double peaked, which is caused by two energy sources [3].

- a low frequency wave energy peak resulting from the open sea windfield propagating over the shoals and
- a high frequency wave energy peak generated by local wind over the shoals.

In figure B the transfer function is given, that has been derived from calculations and was tested in laboratory wave flumes.

In this case the transfer function has high values in that frequency range where the highest peak in the wave spectrum occurs.

This peak is in the low frequency range, that means the low frequency wave energy is mainly responsible for the load on the Eastern Scheldt storm surge barrier [4]. This barrier which is now under construction, consists of 63 openings divided by piers. The openings are 39,5 m wide and will be closed by vertical lift gates during storms.

Normally the gates will be open in order not to interfere with the salt water- and tidal regime in the Eastern Scheldt basin. The worst loading for the barrier will be during the maximum storm surge level. The difference in head between sea level and basin level and the amount of low frequency wave energy penetrating from the North Sea across the shoals are then both at a maximum.

FIG. A WAVE SPECTRUM IN FRONT OF THE BARRIER

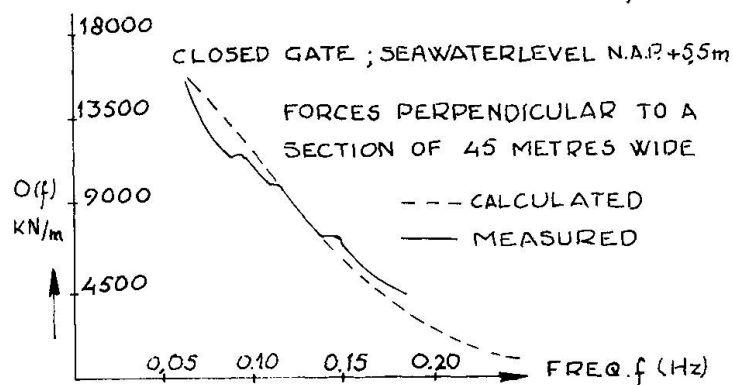
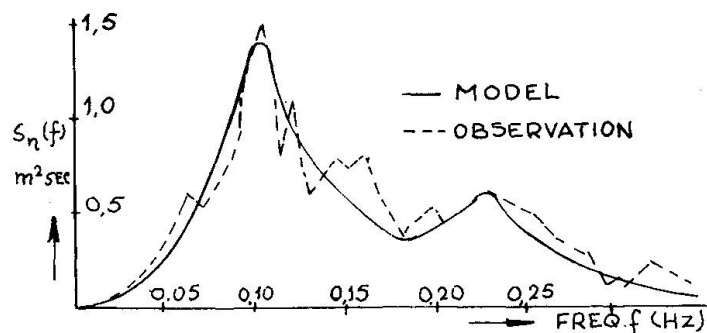

FIG. B TRANSFER FUNCTION

5. RECOMMENDATIONS WITH RESPECT TO THE DYNAMIC LOADS BY WAVE FORCES

The difference in shape of a structure, mainly loaded by a static hydraulic force and one mainly loaded by a dynamic hydraulic force will now be discussed. In the case of a static load the purpose is to find an appropriate shape to bear the given load. When the wave load dominates there is a moving mass of water containing a quantity of energy. The problem is to find a solution to let pass as much energy as allowed and to dissipate the rest-energy as much as possible with a minimum of resulting forces. It may seem a strange solution to let pass a certain amount of energy, in other words to accept that a part of the waves and thus a quantity of water runs over the structure. But it should be noted that many structures like storm surge barriers are located near the coast line. A large water area remains behind, viz. the river or estuary which has been closed off. A limited amount of water overtopping the gates will



not raise the water level too much. When water is stopped abruptly an impact is introduced. This happens when a free water surface (exposed to the air externally or internally in a bubble or a cavitation under vapour pressure) touches a fixed surface parallel with the free water level. When for instance a wave is stemmed in a blind corner of the structure, the moving mass is stopped abruptly and the water decelerates briskly. The result of this is a large impact on the surface. Such a wave impact can be several times larger than the statical load by the same head. Blind corners should therefore be avoided as much as possible.

A good solution can be to design a structure with a low top level to have waves roll over under extreme conditions. Or the opposite; a high bottom level that cannot be reached by the top of the waves (e.g. off-shore platform).

Other solutions are: to have the water escape, to give the fixed wall an other inclination or to incorporate an elastic buffer.

If possible one should prevent that waves break just in front of the surface, which gives the dominant effect of a hammer shock (although somewhat damped by enclosed air). It should be noted that if a structural shape is suitable to limit the discharge as little as possible, it will also minimise the loads onto the structure, because the hydraulic force that acts on the structure is equal to the force which acts from the structure to the water.

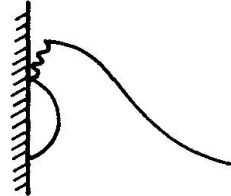

BREAKING WAVE

6. STRUCTURES MAINLY LOADED BY THE DYNAMIC HYDRAULIC FORCES

a. Discharge sluices at the Lauwersmeer and Grevelingen

If an discharge sluice has a rectangular cross-section the waves can hit the roof, causing a large impact. A solution is to design the roof high enough above the water level.

Another approach has been followed with the discharge sluices of the Lauwersmeer and the Grevelingen, which are both in the Netherlands. A low roof has been designed and the gentle seaward side slope of the adjacent dam is continued on the top of the roof of the sluice. In stormy weather the water level is above the roof, and the waves cannot enter the sluice but are attenuated on the slope. The wave load on the gate situated half way the sluice tube is small then. In normal weather conditions, during ebb-tide smaller waves do enter the sluice.

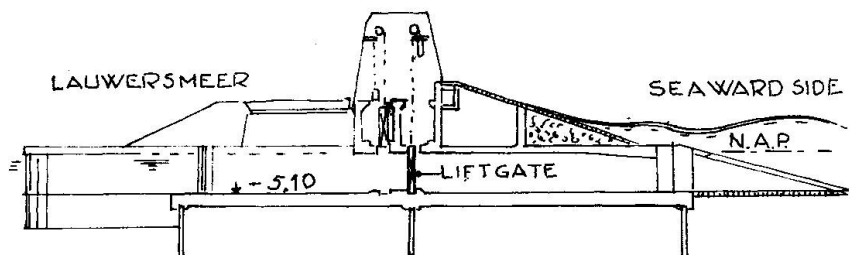

To reduce wave impact on the gate, a groove in the roof near the gate permits the water mass to escape in vertical direction, like in a surge tank preventing water hammer in a long pipe.

As mentioned before the Eastern Scheldt storm surge barrier will be provided with vertical lift gates.

The plating is located on the basin side, while the horizontal girders which transmit the loads to the piers protrude on the seaside. Closed girders would be submitted to vertical wave impact. To reduce this impact

as much as possible the girders will be designed as an open framework constructed of tubular steel work.

b. Discharge sluices of the Haringvliet

The discharge sluices at the Haringvliet in the south west of the Netherlands [5] are another example of a structure mainly loaded by dynamic hydraulic forces. The structure has seventeen 56 m wide apertures, each of which can be closed by a double set of rising sector gates which are connected to a large bridge girder.

The girder that spans from pier to pier transmits the static and dynamic forces on the gates to the piers. The gates can be swung in open or closed position by the long steel arm-connections between gates and girder.

The cross-section of the 'Nabla girder' is a triangle with one horizontal side on top and one vertex on the bottom. The sharp bottom edge prevents the impact of wave tops on a flat horizontal surface, which would give rise to large upward forces on the girder.

The seaward side of the sixteen piers are flush with the steel gates, to prevent blind corners. The gates on the seaward side are lower than the gates on the river side. So during a storm surge, part of the waves run over the gates on the seaward side, thus lowering the dynamic force on the gates under these extreme circumstances.

The backward slope of the gates on the river side is more favourable regarding the wave impacts than the forward slope of the gates on the seaward side.

The floorslab in front of the outer gates is designed at a low level to prevent waves from breaking just before the gates, which would cause very large forces.

In the horizontal plane the abutments form a blind corner with the outer steel gates. In order to avoid high loads on the gate, the wall of the abutment is provided with a wave absorption chamber. This chamber with a few reinforced concrete columns is situated where the abutment meets the outer gate.

The abutments connect the sluices to the dam which has gently sloping faces against which the waves can dissipate gradually by rolling out, like on a natural beach.

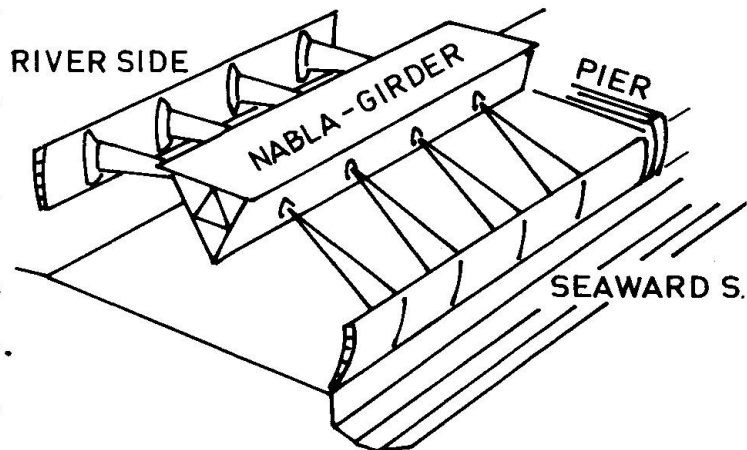
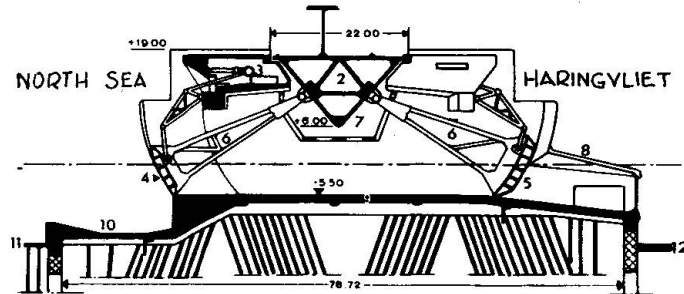

HARINGVLIET-OUTLET SLUICES

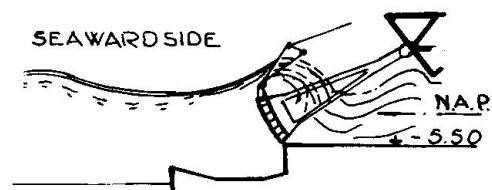
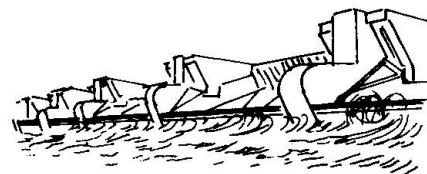



c. Breakwaters

Breakwaters are built to protect harbours and sluices etc. against wave attack and are sometimes used to train currents.

Also here it is often tried to make the top as low as is allowed by its protectional function in order to reduce wave loads acting on it.

If the breakwater is constructed of caissons, loads can be reduced by providing the seaward face with an inclined plane which tends to make the waves roll over. Moreover a stabilising effect results from the vertical component of the wave induced loads. In some designs (e.g. the breakwater berth in the port of Be-Como, Canada) the caisson is provided with a perforated forepart. The way this reduces wave loads will be briefly explained under d (offshore structures).

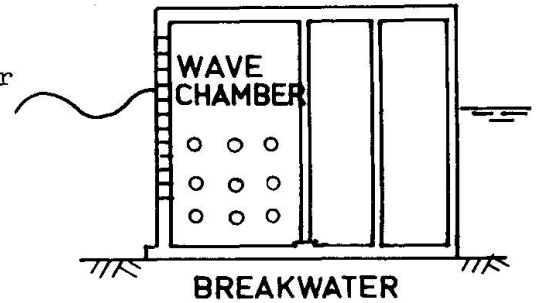
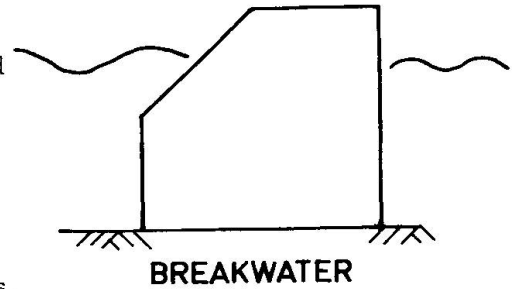

To break large waves, before they strike the breakwater, an underwater berm or dam can be made in front of the breakwater. An alternative for the caisson dam is the open structure built with gravel, rubble and often covered with concrete blocks [6] Such a mole has a gentle slope and a large porosity of about 50% in which the energy is dissipated. Due to the low reflection coefficient, the water level variation has already been reduced.

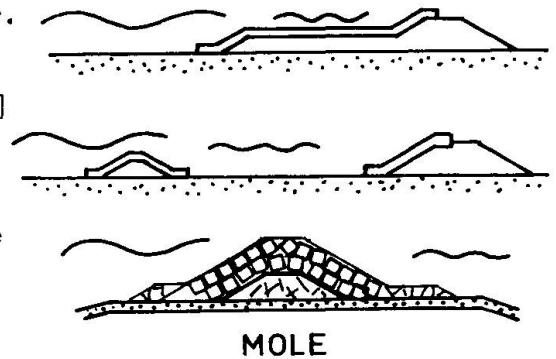

d. Offshore structures

Ekofisk

In some types of offshore structures, like Ekofisk (a storage tank for crude oil with an outer diameter of 92 m and a height of 90 m, placed in the North Sea at a water depth of about 70 m), perforated outer walls are used. The impact of a wave is related to the problem of the so-called added watermass which suddenly has to be decelerated. The quantity of this added watermass is greatly reduced by perforating the wall.

Sometimes more than two walls are used, the openings in each successive wall being smaller than in the preceding one, to dissipate energy in successive steps.

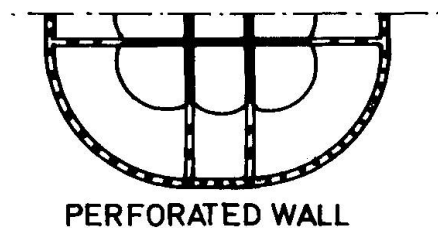

Andoc [7]

The wave loads influence the shape of the structure to be designed. Another example is found in the design of offshore platforms, where e.g. relatively small circular sections of the legs near the sea level reduce the wave forces. The top deck of this structure has been designed



to be outside the influence of the waves. To reduce as much as possible the wave loads caused by orbital motion the diameter of the legs should be small.

Requirements are often contradictory and may arise from other functions (stability during transport, installation of pipes in the interior etc.). It is the designers task to find the right compromise.

The same principle is used in floating structures. The large floating body of the structure is below the water level further beyond the main reach of the dynamic action of the waves. The top deck of the platform is fixed with legs on the floating body.

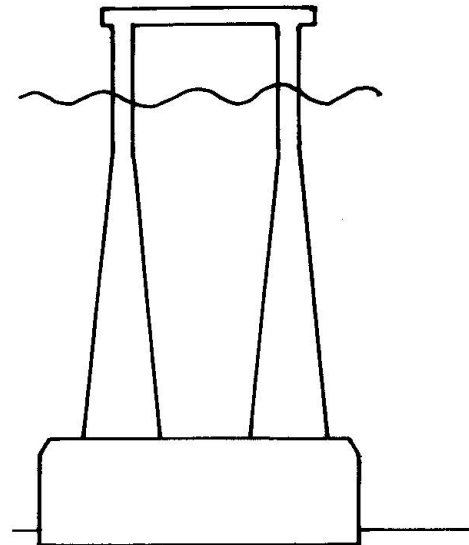

OFFSHORE STRUCTURE

e. Wave power installations

There are structures with installations to accumulate wave energy instead of dissipating the wave energy as described before. Some are designed as floating devices in order to convert wave energy into electrical energy. One type has the shape of a container without a bottom and a hole in the top. As the water level inside the box oscillates by wave action, air is forced through the hole and can be made to drive a turbine. A ship-type craft is moored in the sea of Japan [8]. Another project is designed as rectangular boxes installed on the seabed. The incoming wave enters an upper reservoir. Water is forced through turbines to lower reservoirs and rushes out as the wave retreats.

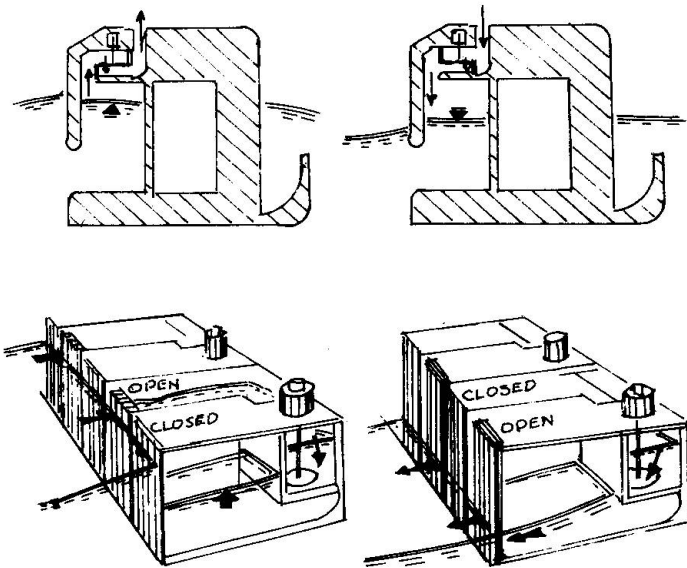



BIBLIOGRAPHY

- 1 A.C. DE GAAY and P. BLOKLAND
"The canalization of the Lower Rhine".
Rijkswaterstaat Communication no. 10 (1970).
Rijkswaterstaat, Directie Waterhuishouding en Waterbeweging,
The Hague, the Netherlands.
- 2 A. GLERUM
"The design of immersed tunnels".
Magazine "Tunnels and Tunnelling", March 1979.
Morgan-Grampian Ltd., London, U.K.
- 3 VARIOUS AUTHORS
"Hydraulic aspects of coastal structures".
Developments in Hydraulic Engineering related to the design of
the Oosterschelde Storm Surge Barrier in the Netherlands, 1980.
Delft University Press, Delft, the Netherlands.
- 4 VARIOUS AUTHORS
"Eastern Scheldt Storm Surge Barrier".
Edition in English of the articles in "Cement" no. 12, 1979.
A monthly magazine issued by the Netherlands Concrete Society.
- 5 H.A. FERGUSON, P. BLOKLAND, H. KUIPER
"The Haringvliet Sluices".
Rijkswaterstaat Communication no. 11, 1970.
Rijkswaterstaat, Directie Waterhuishouding en Waterbeweging,
The Hague, the Netherlands.
- 6 J.F. AGEMA
"Havendammen aan Zee".
"Cement" no. 12, 1972
- 7 D. ZIJP, B. VAN DER POT, C. VOS, M. OTTO
"Dynamic analysis of gravity type offshore platforms; experience,
development and practical application".
Paper OTC 2433, 1976; Offshore Technology Conference, Dallas
(Texas), USA.
- 8 J. CRANFIELD
"Interest in wave power growing".
Magazine Ocean Industry, February 1979.