

Effects of Vrancha earthquake of 4 March 1977 on the territory of Bulgaria

Autor(en): **Sachanski, S.**

Objekttyp: **Article**

Zeitschrift: **IABSE reports of the working commissions = Rapports des commissions de travail AIPC = IVBH Berichte der Arbeitskommissionen**

Band (Jahr): **30 (1978)**

PDF erstellt am: **20.09.2024**

Persistenter Link: <https://doi.org/10.5169/seals-24185>

Nutzungsbedingungen

Die ETH-Bibliothek ist Anbieterin der digitalisierten Zeitschriften. Sie besitzt keine Urheberrechte an den Inhalten der Zeitschriften. Die Rechte liegen in der Regel bei den Herausgebern.

Die auf der Plattform e-periodica veröffentlichten Dokumente stehen für nicht-kommerzielle Zwecke in Lehre und Forschung sowie für die private Nutzung frei zur Verfügung. Einzelne Dateien oder Ausdrucke aus diesem Angebot können zusammen mit diesen Nutzungsbedingungen und den korrekten Herkunftsbezeichnungen weitergegeben werden.

Das Veröffentlichen von Bildern in Print- und Online-Publikationen ist nur mit vorheriger Genehmigung der Rechteinhaber erlaubt. Die systematische Speicherung von Teilen des elektronischen Angebots auf anderen Servern bedarf ebenfalls des schriftlichen Einverständnisses der Rechteinhaber.

Haftungsausschluss

Alle Angaben erfolgen ohne Gewähr für Vollständigkeit oder Richtigkeit. Es wird keine Haftung übernommen für Schäden durch die Verwendung von Informationen aus diesem Online-Angebot oder durch das Fehlen von Informationen. Dies gilt auch für Inhalte Dritter, die über dieses Angebot zugänglich sind.

EFFECTS OF VRANCHA EARTHQUAKE OF 4 MARCH 1977 ON THE TERRITORY
OF BULGARIA

S. Sachanski - Dr. Eng. Head Dept. Seismic Mechanics, Bulgarian Academy of Sciences, Sofia, Bulgaria.

SUMMARY

The spectral characteristics (predominant periods, Fourier transform spectra, response spectra) of Romanian earthquake on 4 March 1977 are analysed in respect to explain the causes of destruction of buildings located 200-500 km from epicentre.

Effects of the earthquake on masonry buildings, reinforced concrete frame, large panel and industrial buildings are analysed.

SOMMAIRE

Les caractéristiques spectrales (périodes prédominantes, spectre de transformation de Fourier, spectre de réponse) du tremblement de terre à Roumanie de 4.III.1977, sont analysées. Ces caractéristiques sont utilisées comme explication des facteurs qui ont produit les dégâts des bâtiments et des constructions, situés à environ 200-500 km de l'épicentre.

Les effets du tremblement de terre sur des maçonneries des bâtiments fait en béton armé monolithique et préfabriqué, sont analysés.

ZUSAMMENFASSUNG

Die spectralische Charakteristiken (die dominierende Perioden, das Fourierische Transformationspektrum, das Resonanzspektrum) des Rumänischen Erdbebens vom 4. März 1977 sind analysiert. Diese Charakteristiken sind notwendig um die Zerstörungsgründe der Bauwerke, die 200-500 m vom Epizentrum entfernt sind, festzustellen.

Der Einfluss des Erdbebens über Mauer- und Stahlbetonwerke (monolithische und aus Fertigbauteile) ist beschrieben.

1. INTRODUCTION

The earthquake of 4 March 1977 with epicenter Vrancha-Romania, focal depth of 110 km and magnitude 7,3 had an effect on the territory of Bulgaria with intensity IV-VIII according to MSK-64 scale. This earthquake collapsed few new reinforced concrete buildings, heavily damaged hundreds and cracked thousands. Many tall buildings in Sofia, located 450 km from epicenter, were significantly cracked and some of them had to be repaired. Three R.C. frame buildings in Svistov on Danube bank with flexible first storey were completely collapsed and killed 138 inhabitants.

The earthquake have had an strong effect over the all territory of Bulgaria damaged many old and new modern residential and industrial buildings built by monolithic reinforced concrete and precast panels and elements. This is the reason the effects from the earthquake to be analysed and conclusions for improvement of the earthquake resistant designing to be suggested.

2. SPECTRAL CHARACTERISTICS OF VRANCHA EARTHQUAKE

The specific mechanism of Vrancha earthquake with focal depth of 110 km had generated seismic waves with long predominant periods 1-2,4 sec which strongly effected the tall and flexible buildings up to 500 km.

On the accelerograms recorded in Bucharest (INCERC), at distance 170 km from epicenter, can be seen typical sinusoidal character of the motion after 18 sec for both NS and EW components (fig.1). The accelerograms in Nish (453 km from epicenter) (fig.2) contain similar long period motion combined with short period waves specified by the geological conditions.

The Fourier transform spectra from Vrancha earthquake for Bucharest [1] and Nish [2] records and experimentally determined period [3] at right bank of Danube river (300 km from epicenter) are given on (fig.3). It is evident that specific deep geological conditions with short natural predominant periods for surface layers generate additional short motions (fig.2). Well known filtration of the short period waves with distance is not observed in this case. There are some regions on the territory of Bulgaria which generate short period motions and others one-long periods. This fact was confirmed by the behaviour of the structures with different natural periods located at different ground conditions.

The response spectra for Bucharest record NS component, El Centro 1940 NS component and Svistov NS probable component at 0% critical damping are given on (fig.4). It is evident that Vrancha earthquake effect significantly the flexible structures with natural periods $T > 1$ sec. On this bases can be explained the large numbers of the damages in flexible structures. In some specific regions small buildings of one-two storeys had been heavily damaged

The isoseismal map of Vrancha earthquake on the territory of Bulgaria (fig.5) is influenced significantly by the geological conditions- specially on alluvial deposits at the rivers valley. The

most affected area—right bank of Danube is characterised by alluvial deposits and loessoidal surface layers of thickness 5 to 30 m.

3. EFFECTS OF THE EARTHQUAKE ON THE BUILDINGS

The earthquake of 4 March 1977 damaged mainly nondesigned for earthquakes buildings and structures. The buildings designed for earthquake intensity VII or VIII got nonstructural cracks only in infilling walls, joints and so on.

3.1. One-two storeys brick masonry buildings

In the most effected area—Svistov (point 1 on fig. 5) one storey brick masonry buildings did not get any cracks. Two storey very old buildings (fig. 6) with wooden floors did not suffered significantly. Some of them got small cracks (fig. 7) Some old buildings from last century (fig. 8) not designed for earthquakes but well built with steel connections between walls were damaged mainly in connections between timber roofs and masonry. In some other areas (point 2 on fig. 5) one and two storeys masonry buildings were heavy damaged. Those buildings had been built with low strength bricks and mortars (mud or lim-sand), timber floors and roofs non connected well with walls (fig. 9).

The damages of this type buildings in diferent areas depend of geological conditions and specialy of predominant periods of surface layers.

3.2. Reinforce concrete frame buildings with flexible first storey

The most suprising effect of this earthquake was the total colaps of three reinforce concrete buildings without shear walls in first floor. This colapse can be explained by specific response spectra with maximum at $T > 1$ sec (fig. 4), sinusoidal exitation in both directions, large horizontal displacements and additional influence of P- Δ effect on the bending moments into the columns.

The fifth storey office building (fig. 10) is typical building with flexible first storey. The existing of shear walls at the stairs only develop additional rotational effects and reserve partly only first two storeys at the stairs (fig. 11). The cylindrical columns of the building are well designed (fig. 12) but connections between girders and columns did not forme space resisting frame for horizontal exitation. The small length of down girders steel bars into columns (fig. 10 b) was not capable to bear suficient bending moments from the earthquake. Similar construction had the sixt storeys public residential building wich was colapsed on the same way (fig. 13).

The nine storeys apartment building with shops (without shear walls) into first storey was colapsed as previous two buildings (fig. 14). Another two nine storeys buildings with the same construction but with masonry shear walls in first storey have resisted very well to the earthquake (fig. 15).

One more example of distortion this type construction is the total

collapse of industrial bunker constructed like reinforce concrete box supported on four R.C. columns (height-6m).

Many reinforce concrete frame buildings and package lift-slabs buildings with infiling masonry walls were cracked mainly in walls never maind they were not designed for earthquake.

3.3. Large panel and precast buildings

Many large panel buildings were effected by the earthquake but of the reason of low natural periods ($T \approx 0,4$ sec) they did not get any damages. Not designed for earthquake large panel buildings in some regions were lightly cracked in horizontal joints and corners of the doors.

The damages in many industrial buildings were mainly from bed connections between roof trusses and columns (fig.16) between roof ,wall panels and columns.

4. CONCLUSION

The specific spectral characteristics of Vrancha earthquake of 4 March 1977 effects mainly flexible structures. In some regions with rigid ground conditions the exitation was strong on small rigid buildings. Many tall buildings in Sofia (about 20 storeys) located on aluvial ground were cracked and some had to be repaired. This super long distance effect of Vrancha earthquake is influenced from specific mechanism of the earthquake and deep geological conditions of respective regions. The buildings with flexible first storey have to be designed taking into consideration the large displasiment of the ground, long distance effect and resonance from sinusoidal waves. In the regions with longe distance effects this type of construction have to be avoid.

Large panel and precast constructions non designed have resisted very well to this earthquake. Special attantion have to paid to the quality of realization on place of the joints between separate elements.

Earthquake resictance designed and well built constructions, according to the normes, have resisted very well to the earthquake.

REFERENCES

1. Tezcan S. at all Romanian Earthquake of March 4, 1977.
2. IZIIS-Skopje Analysis of strong motion records of the Vrancha Romania ertquake of March 4, 1977, obtained in Nish - Yuggoslavia.
3. Sachanski S. Probabale spectral characteristics of Romanian Eathquake of March 4, 1977 on the territory of Bulgaria . 1977.

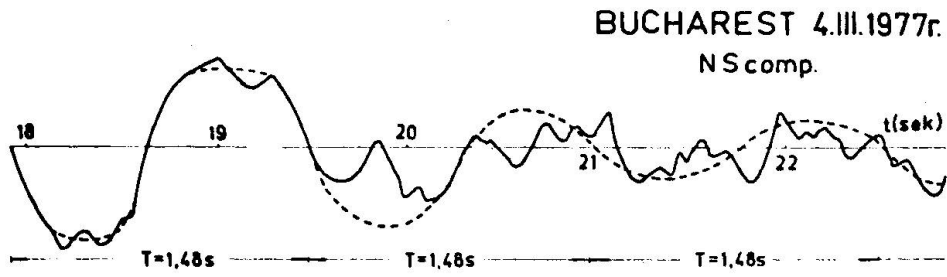

fig. 1

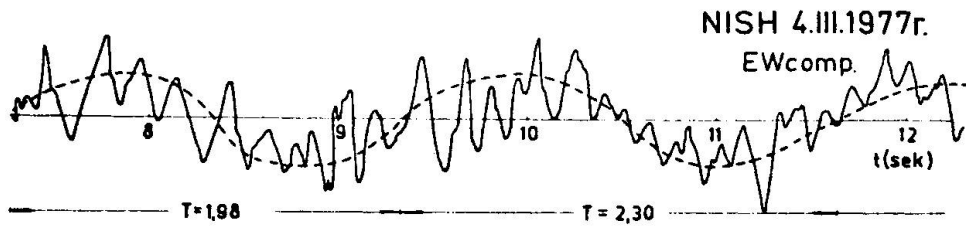

fig. 2

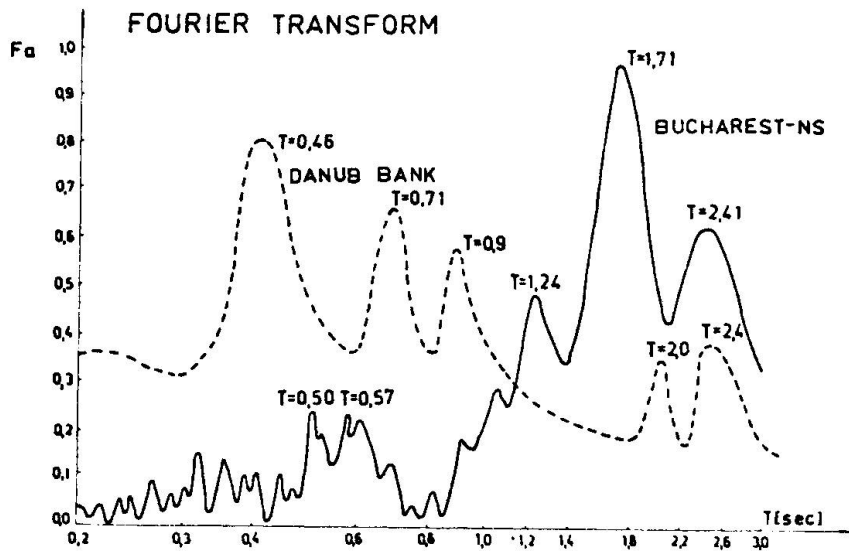

fig. 3

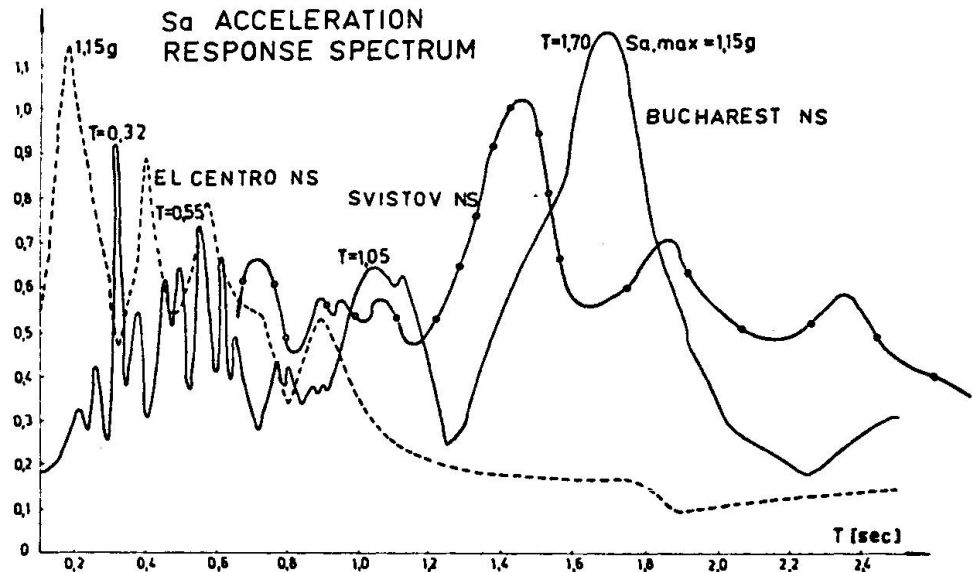

fig. 4

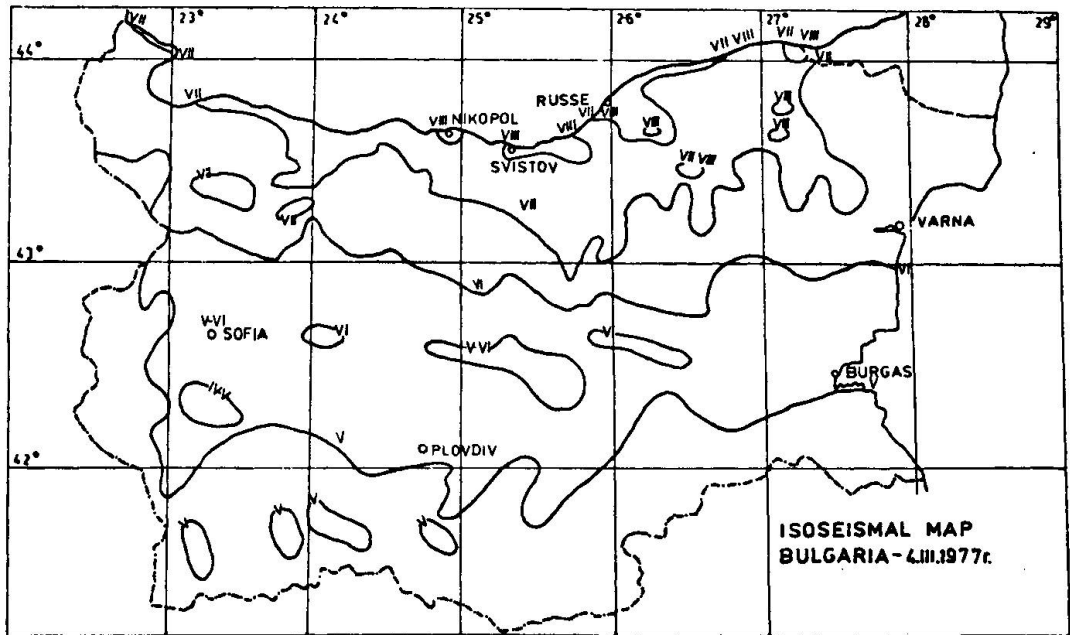

fig. 5



fig. 6

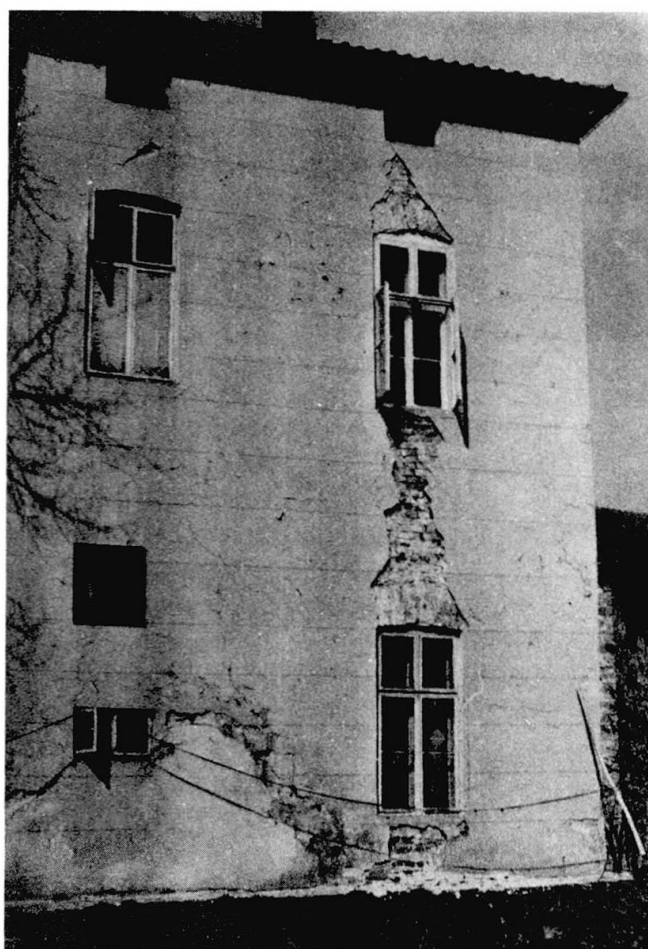

fig. 7

fig. 8

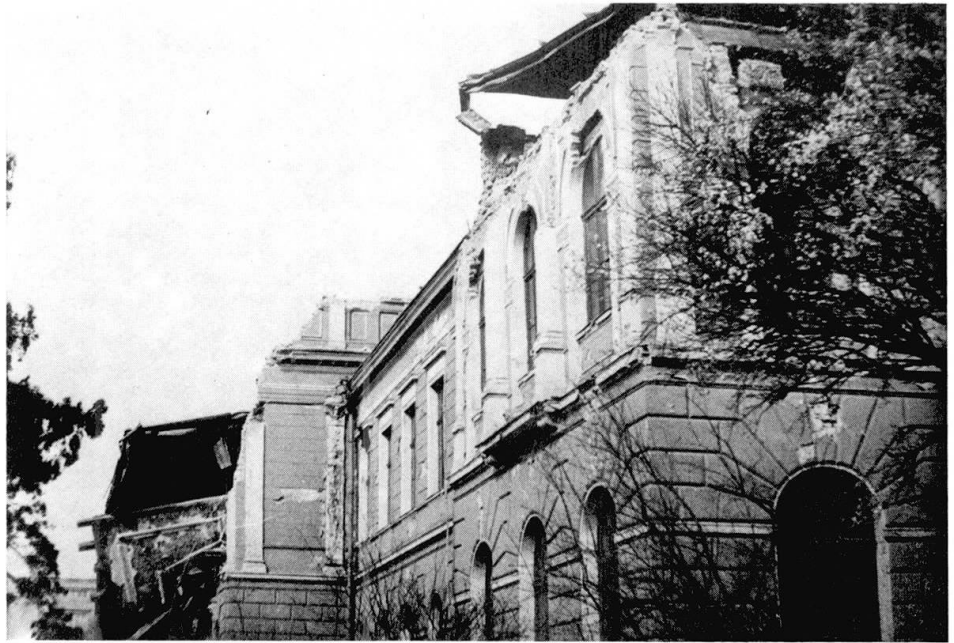

fig. 9

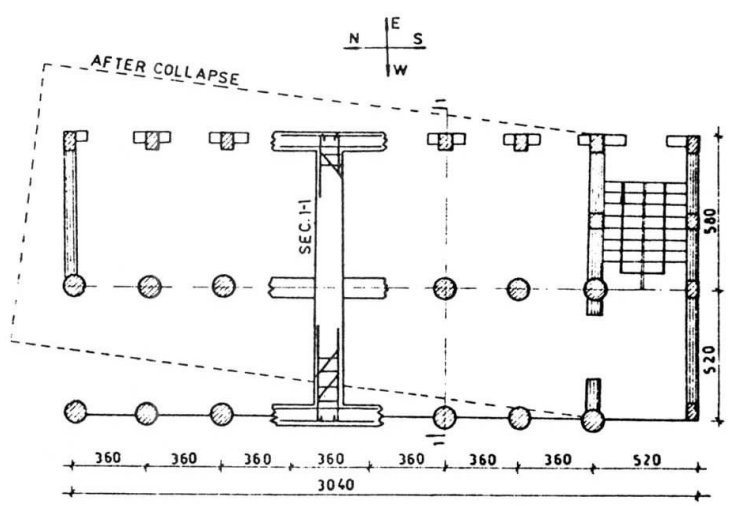

fig. 10



fig. 11

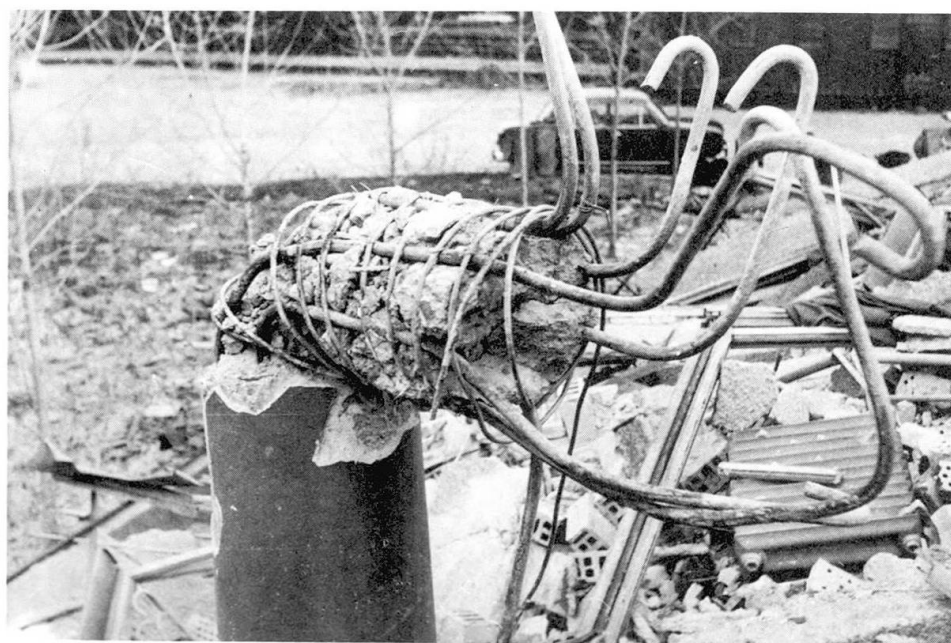

fig. 12



fig. 13



fig. 14



fig. 15

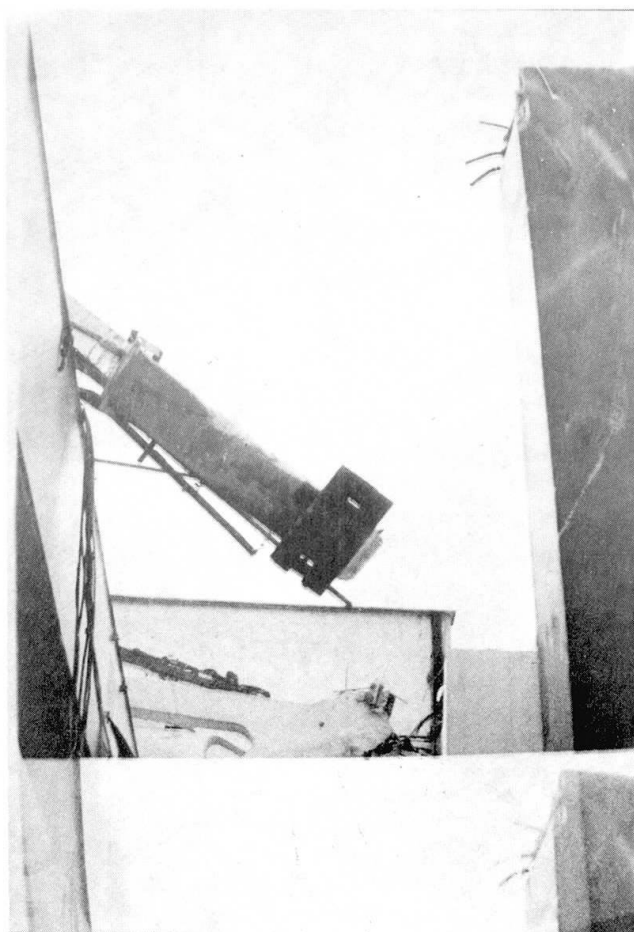

fig. 16