

Session II: Repairs and reconstruction of the structures

Objektyp: **Group**

Zeitschrift: **IABSE reports of the working commissions = Rapports des commissions de travail AIPC = IVBH Berichte der Arbeitskommissionen**

Band (Jahr): **30 (1978)**

PDF erstellt am: **20.09.2024**

Nutzungsbedingungen

Die ETH-Bibliothek ist Anbieterin der digitalisierten Zeitschriften. Sie besitzt keine Urheberrechte an den Inhalten der Zeitschriften. Die Rechte liegen in der Regel bei den Herausgebern.

Die auf der Plattform e-periodica veröffentlichten Dokumente stehen für nicht-kommerzielle Zwecke in Lehre und Forschung sowie für die private Nutzung frei zur Verfügung. Einzelne Dateien oder Ausdrucke aus diesem Angebot können zusammen mit diesen Nutzungsbedingungen und den korrekten Herkunftsbezeichnungen weitergegeben werden.

Das Veröffentlichen von Bildern in Print- und Online-Publikationen ist nur mit vorheriger Genehmigung der Rechteinhaber erlaubt. Die systematische Speicherung von Teilen des elektronischen Angebots auf anderen Servern bedarf ebenfalls des schriftlichen Einverständnisses der Rechteinhaber.

Haftungsausschluss

Alle Angaben erfolgen ohne Gewähr für Vollständigkeit oder Richtigkeit. Es wird keine Haftung übernommen für Schäden durch die Verwendung von Informationen aus diesem Online-Angebot oder durch das Fehlen von Informationen. Dies gilt auch für Inhalte Dritter, die über dieses Angebot zugänglich sind.

SESSION II

Repairs and Reconstruction of the Structures

CHAIRMAN: Dr. Alfonso Alvarez Martinez, Madrid, Spain

CO-CHAIRMAN: Prof. Giuseppe Grandori, Milan, Italy

Leere Seite
Blank page
Page vide

POST EARTHQUAKE CONSTRUCTION OF GEDİZ

Aybars Gürpınar

Associate Professor of Engineering Sciences
Earthquake Engineering Research Institute
Middle East Technical University, Ankara Turkey

SUMMARY

The town of Gediz in Western Turkey was struck by an earthquake in March 1970. Since then the Turkish government has built a new town (New Gediz) about 8 kms from the original location. As the old town is still habitated the problem has arisen for the government to investigate and decide about the suitability for habitation of Gediz from the point of view of seismic risk. The present report is a culmination of such an investigation.

1. INTRODUCTION

1.1 Scope of the Problem

A devastating earthquake struck the town of Gediz and environs in March 1970. The damage due to this earthquake coupled with the fire caused by it destroyed some parts of the town. The government decided at that time to relocate the town. Peculiar topographical conditions of Gediz was one of the factors which caused panic in the inhabitants who in turn pressured the authorities to make the decision of relocation. The new town (called New Gediz) was constructed about 8 kilometers south of the old location and within two years it became a lively center of habitation. Today New Gediz has a population of about 12000.

The old town, on the other hand, did not disintegrate into a ghost town either and is occupied by about 7000 inhabitants today, approximately 70% of the population it had in 1970, before the earthquake. As the town offices have moved to New Gediz, the inhabitants of Old Gediz have again formed a pressure group to demand municipal facilities from the government.

This article is the summary of the investigation carried out by the Middle East Technical University Earthquake Engineering Research Institute to determine the suitability of Old Gediz for habitation with respect to seismic considerations, as requested by government authorities.

1.2 Pre-Earthquake Gediz

The town of Gediz had a population of 10651 according to the October 1970 census. In the province of Kütahya it was one of the four towns with population over 10000. For this reason it had a certain amount of social and commercial activity. This is influential to some extent to the number of public and civic buildings in the town in contrast to traditional dwellings.

The town is located in the valley of a river of the same name, (Figure 1). In the center of the town a peculiar basaltic formation underlying rubble dominates the scenery, (Figures 2 and 3). The river runs through this formation leaving a strip of narrow flat land on each side for suitable habitation. However, this land was densely populated before the earthquake. Although not as densely as this part; the 'castle' (as the basaltic formation is locally called) also provided habitable land to a considerable population.

The type of construction in Gediz prior to the earthquake may be classified in three categories.

- reinforced concrete frame
- wood frame
- stone or brick masonry

Almost all reinforced concrete buildings were non-residential. These were schools, banks, dormitories, hospitals, etc and totaled to no more than fifteen in Gediz.

By far the most common residential type of construction in Gediz is wood frame. A typical Gediz house of this type (**Hımsı**) may be seen in Figure 4. The major deficiency of this type of construction during an earthquake is the danger of loose infill, improper diagonal bracing and poor masonry foundation. A more refined version of this type of construction may be seen in

Figure 5. The first two points of deficiency are generally taken care of in this type (balıdadi) of construction.

Only 5-10% of buildings in Gediz were masonry [1]. But even such a small number of masonry structures influenced the number of casualties to a great extent.

2. EVENT OF MARCH 28, 1970

The Gediz earthquake occurred at 21 02 23.5 local time and had a magnitude of 7.3 on the Richter scale. The epicentral intensity was controversial and was given as VIII and IX on the Modified Mercalli scale by different experts. The epicentral coordinates were given as 39.21 N, 29.51 E and the focal depth was calculated as 18 kms.

The epicenter lies about 20 kms NW of the town of Gediz. The earthquake was felt in an area of 350000 square kilometers and had an intensity of MM \geq VII over an area of 1250 square kms.

According to Uzsoy and Çelebi [1], although the material and workmanship of reinforced concrete structures were sub-standard they performed satisfactorily during the earthquake. None of these collapsed completely.

The major causes of failure for wood frame structures were spilling of loose infill material, inadequate cross bracing and poor foundation. Sidesway of one such building due to inadequate cross bracing may be seen in Figure 6. On the whole, however, wood frame structures behaved exceptionally well during the earthquake.

Stone and brick masonry (unreinforced) structures behaved poorly and unpredictably. When they failed their failure was almost total and frequently catastrophic.

A disadvantage of wood structures was observed during the fire which followed the earthquake. Due to the narrowness of the streets near the quay and blockage by debris made it impossible for rescue teams to reach the affected area increasing the number of casualties considerably.

Total number of casualties due to the earthquake (including fire casualties) totaled 1086 of which 360 were from Gediz. The relative destructiveness of the Gediz earthquake to those recently occurred in Turkey may be seen in Table 1, (from [2]).

3. SEISMIC RISK CONSIDERATIONS

3.1 Methodology

Seismic risk of Gediz and its environs were considered using the method developed by Cornell and Mertz [3] revised by Shah et al [4] and Gürpınar and Gülkan [5]. First of all, seismic sources are selected based on seismicity and tectonics of the considered area. All the past epicenters are then associated with one of these sources. Frequency-magnitude relationships are established for each source and maximum magnitudes that may be generated by these sources are estimated. Iso-acceleration contours for given exceedance probabilities and time periods are drawn for the considered region.

Characteristics of seismic sources may be seen in Table 2.

3.2 Regional Comparison of Seismic Risk

Iso-acceleration contours for 20% probability of exceedance and 50 year time period may be seen in Figure 7. Peak ground acceleration values for some towns in the region are as follows: Gediz, 850; Emet, 780; Simav, 770; Uşak, 690; and Kütahya, 640; all in gals.

It should be pointed out that New Gediz which is only 8 kms south of the old town is still within the 800 gal contour. Although Gediz has the largest peak ground acceleration value for given probability of exceedance and time period, the difference between Gediz and other towns (such as Emet and Simav) is not appreciable enough to decide against habitation in Gediz. The risk curves for 1, 20 and 50 year periods may be seen in Figure 8.

4. MICROZONING CONSIDERATIONS

Microzoning of Gediz is considered from the following points of view:

- proper land usage (industrial, residential, green area, etc)
- spacing and height restriction of buildings in each zone
- proper seismic coefficient for each zone

In doing this, three major factors were considered as hazard potentials.

- soil amplification of earthquake ground motion
- landslide potential
- fire potential

Fifteen bore holes were drilled and a resistivity study was carried out to determine the influence of the first two points on microzoning. Unfortunately, microzoning of Gediz has not been completed at the time of the writing of this article.

REFERENCES

1. UZSOY, Ş.Z. and ÇELEBİ, M. 28 March 1970 Gediz Earthquake, M.E.T.U. Ankara, 1970 (in Turkish)
2. 24 November 1976 Çaldıran Earthquake, Rep. Ministry of Reconstruction and Resettlement, Ankara, 1977
3. CORNELL, C.A. and LERTZ, H.A., "Seismic Risk Analysis of Boston", Journal of the Structural Division, ASCE, v.101 October 1975
4. SHAH, H.C. et al, A Study of Seismic Risk for Nicaragua, Part I, The John A. Blume Earthquake Engineering Center, Stanford University, 1975
5. GÜRPINAR, A. and GÜLKAN, P. "Seismic Risk Analysis of Northwestern Turkey", Proc. Antiseismic Design of Nuclear Installations, Rome, 1977

Western Turkey					Eastern Turkey				
Earthquake	I ₀	N	M	r	Earthquake	I ₀	N	M	r
Adapazarı 27.7.67	IX	89	5569	16	Varto 19.8.66	IX	2394	20007	120
Amasra 1.9.68	VIII	29	2072	14	Pülümür 26.7.67	VIII	97	1282	76
Alaşehir 28.3.69	VIII	41	1700	11	Bingöl 22.5.71	VIII	870	5356	162
Gediz 28.3.70	IX	1086	9452	114	Lice 6.9.75	VIII	2385	8165	292
Burdur 12.5.71	VIII	57	1487	18	Çaldıran 24.11.76	IX	3840	9232	415
Total	8.4 Ave.	1302	22280	38 Ave.		8.4 Ave.	9586	4042	213 Ave.

N: number of loss of life

M: number of heavily damaged structures

r: number of loss of life per 1000 destroyed structures

Table 1. A Comparison of Recent Turkish Earthquakes

Source	Length (km)	Average Focal Depth (km)	Distance to Gediz (km)	a	b
1	105	33.8	34.8	3.8990	-0.5541
2	110	27.3	30.2	3.5428	-0.5073
3	105	27.3	33.9	4.6003	-0.7332
4	150	39.0	55.9	4.7865	-0.6454

a,b: regression constants of frequency-magnitude relationships

Table 2. Seismic Source Characteristics



Figure 1. General View of Gediz



Figure 2. Gediz-Peculiar Topographical Feature



Figure 3. Ruins of a Mosque on Basaltic Formation



Figure 4. Typical Wood Frame Structure (Hımsı)

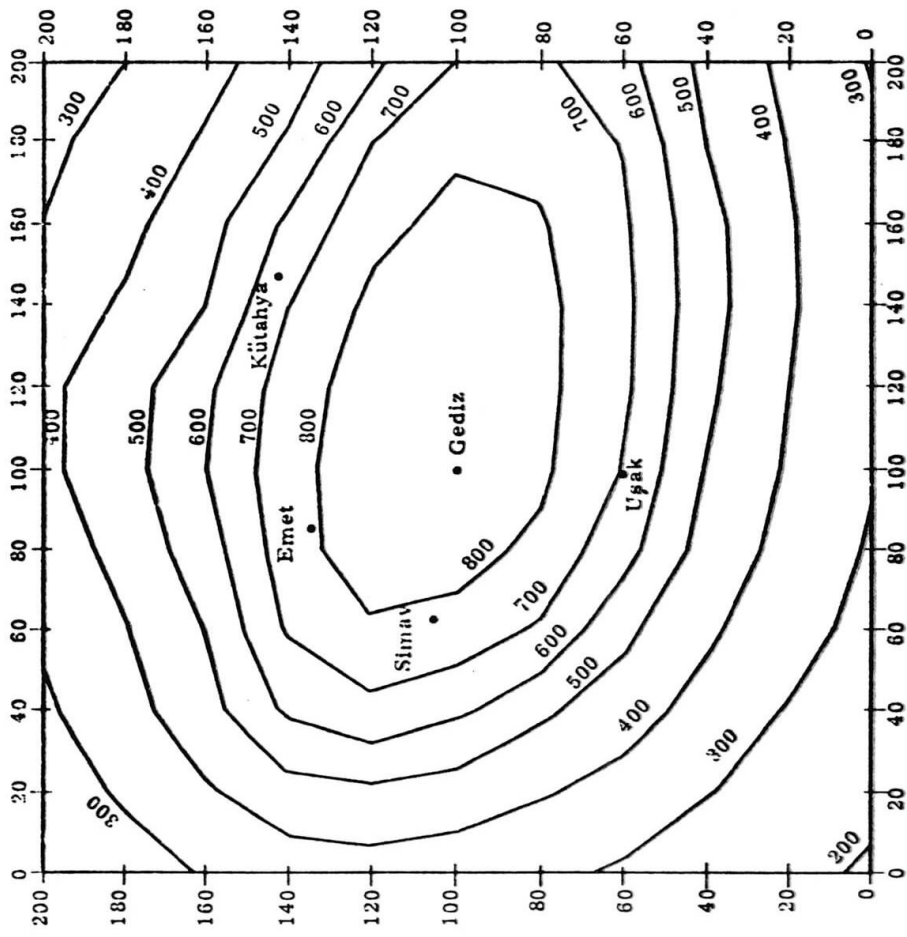

Figure 7. Iso-Acceleration Contours for $P(A) = 0.20$ 50 Years

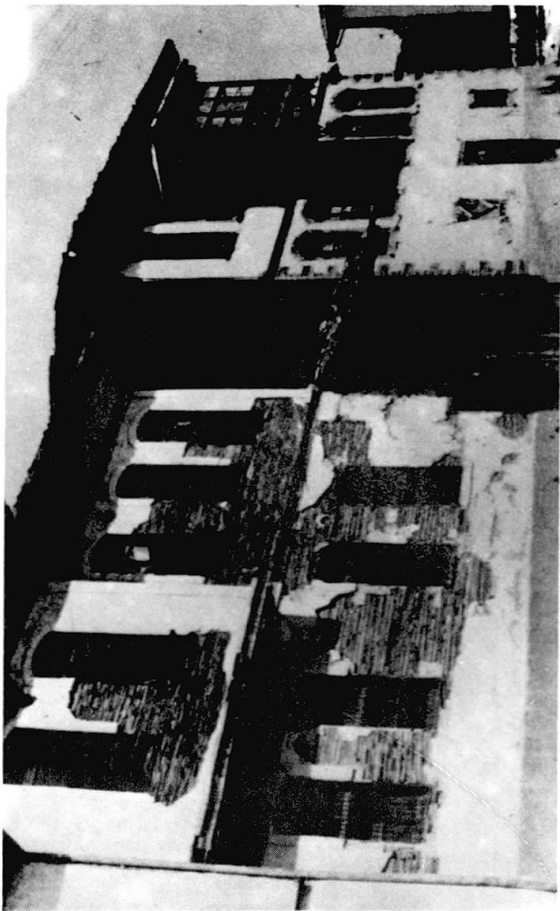

Figure 5. Typical Wood Frame Structure (Bagdad)

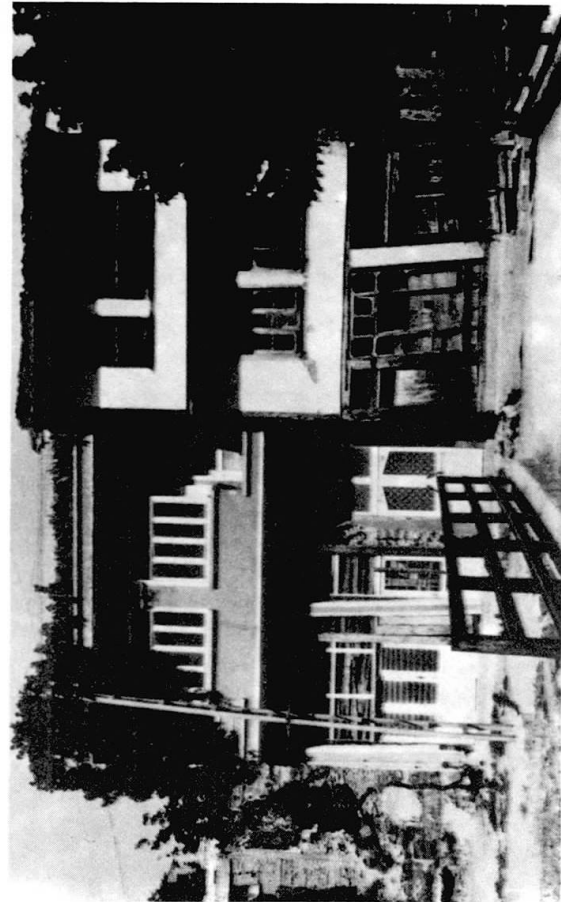

Figure 6. Sidesway Caused by Inadequate Cross Bracing

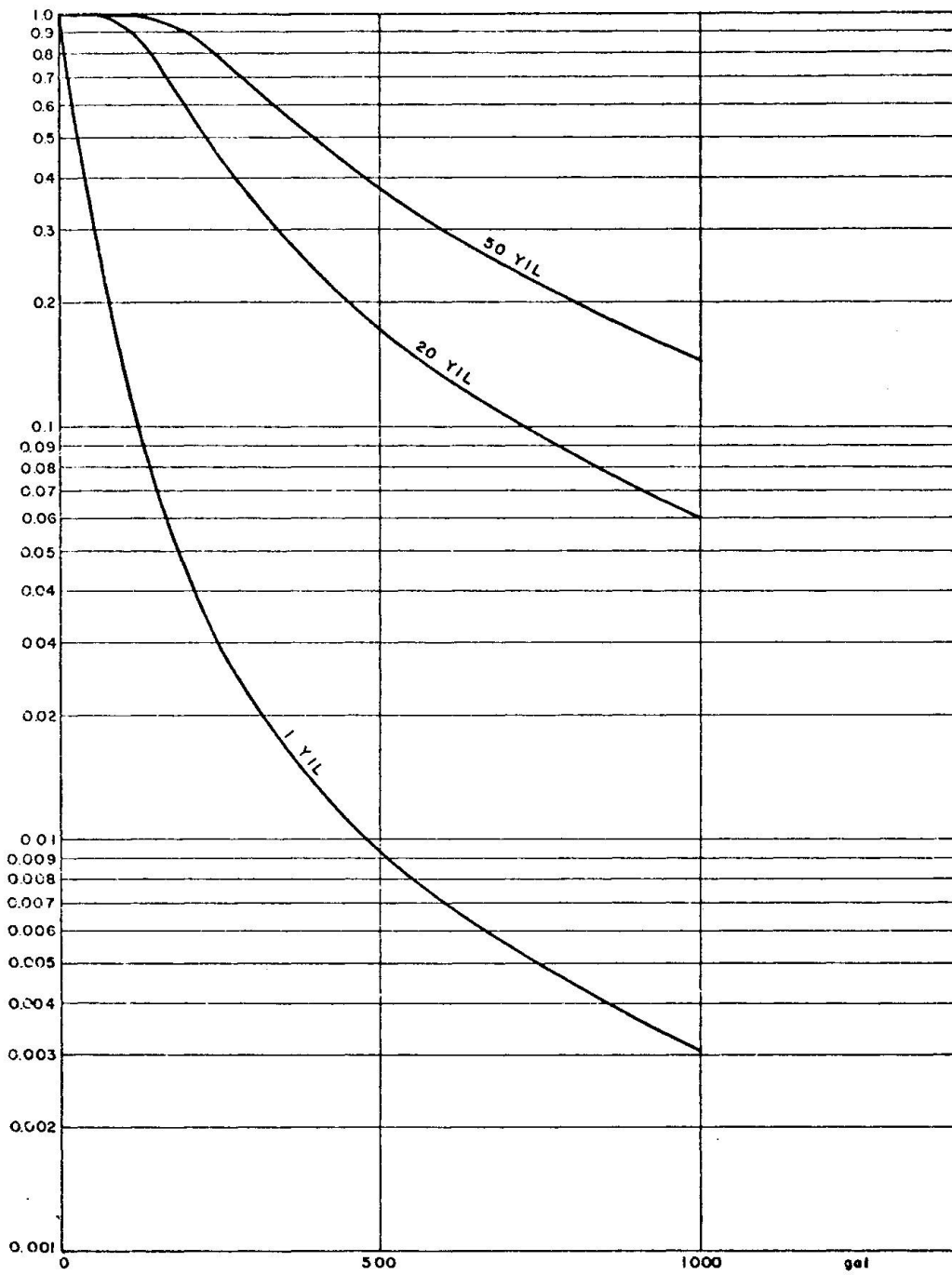

Figure 8. Seismic Risk Curves for Gediz- 1,20,50 Years

IABSE / ISMES -- SEMINAR ON CONSTRUCTIONS IN SEISMIC ZONES
Session: Repairs and reconstruction of the structures

STRUCTURAL REPAIR OF MONUMENTAL MASONRY BUILDINGS

ALBANESI SILVIO, engineer, assistant, University of Ancona (Italy)
BEER PAOLO, engineer, assistant, University of Ancona
GIACCHETTI ROBERTO, engineer, graduate technician, Univ. of Ancona
GUIDI VITTORIO, engineer, builder, Ancona
MENDITTO GIOVANNI, professor of civil engineering, Univ. of Ancona

SUMMARY.

This report deals with some structural repairs performed on monumental and historical buildings in the Marche district (Italy). The structural repairs deal particularly with floors, masonry walls, foundations, arches, vaults and domes.

RESUME. RESTAURATION STRUCTURALE SUR DES BATIMENTS MONUMENTALS
Dans cette communication sont illustrées quelques techniques de restauration structurale réalisée sur des bâtiments monumentaux de la région Marche. En particulier les interventions concernent: les planchers, les murs, les fondations, les arcs, les voutes et les dômes.

ZUSAMMENFASSUNG. STRUKTURALE RESTAURATION VON MONUMENTAL GEBÄUDEN - In dieser publikation werden einige technische Restaurationsarbeiten an Monumental gebäuden - insbesondere an Decken, Mäuern, Fundamenten, Bögen, Gewölben und Kuppeln - erläutert.

1. INTRODUCTION

The repair and strengthening of a masonry construction damaged by an earthquake have the intention of restoring the building to the previous service and, at the same time, to assure the resistance of the whole and of each part against seismic forces of fixed intensity.

This report deals with some structural repairs performed on monumental and historical buildings in the Marche district (Italy).

The general criteria and some specific techniques of structural repairs against earthquake are emphasized. At the same time the remarkable difficulties that arise when dealing with very old and sometimes crumbling buildings are pointed out. We underline the difficulties of having to work in the presence of imposed structural solutions, patterns and technologies associated with dimensional problems which imposed the employment of the tools as well as the mobility of the workmen and, sometimes, the type of reinforcement.

2. GENERAL CRITERIA OF STRUCTURAL REPAIR

The chosen structural repair techniques are founded on the employment of concrete with ordinary tensile strength reinforcing or prestressing steel and fundamentally result in microsewing, binding, bracing, cages, etc. . In special cases steel frameworks and lattices mashed in a suitable way are employed.

The architectonic requirement of preserving, almost everywhere, the original patterns of the skin-walls of the enclosures and the partitions, has prevented the choice of repairing the structure by covering the masonry.

However, the remarkable geometrical consistency of the structures, typical for the buildings under consideration, has allowed us to obtain the reinforcement of the masonry making use of the hollow spaces. In this manner a repair that leaves all cultural values of the building unaltered in obtained.

3. EXAMPLES OF STRUCTURAL REPAIRS

3.1 Foundations

When a change of the foundation ground associated with reduced consistency in the foundation masonry due to the mortar alteration is verified, it is sometimes found necessary to use vertically-inclined micropoles in a fan-shaped arrangement in order to affect a wide area of ground. At this stage the problems connected with the

interaction ground-foundation should obviously be taken into account.

These micropoles should be drilled with machines of moderate dimensions which are able to be introduced easily in closed spaces through normal openings and which have no height problems.

The micropoles diameter, range 8 + 14 cm, can be variable (as a spyglass) while the length is connected with the stress-working values of the ground and obviously limited by the highest allowable loads for each diameter.

After the arrangement of the reinforcement with steel bars, the casting takes place with a mortar injection under pressure so that an improvement of the foundation masonry is obtained too.

In the foundation the manufacture of the reinforced concrete lintols is made with full cuts of the masonry for a height equal to that of the lintol to be inserted. During such a stage the overhanging wall is supported with casting-embodied steel jacks provided with a screw and put into action with a torque wrench in order to check the applied stresses. Then dihedral-shaped formwork is applied to facilitate the performance of the casting. Finally the filling up of the whole space is obtained with pressurising starting from the top making use of suitable vibrators.

During these works there aren't any structural movements, in contrast to the traditional arrangements of lintol erecting done step-by-step without any supports.

3.2 Masonry walls

The masonry mesh with bearing functions, of closed quadrilateral shape possibly regular and balanced is selected in the plan of the building. Then it is propped up with a vertical and horizontal reinforcing mesh using prestressed concrete tendons.

The perforation performed by rotation is obtained with a hydraulic engine working to a low number of revolutions in order to avoid excessive vibrations that are harmful for the masonry. The hydraulic engine is of limited dimensions so that it is possible to arrange a remarkable handling of the drill and there is the possibility of working to different heights placing the oil-dynamic station on the soil level. Therefore the transmission of the fluid takes place with rubber pipes over ten metres in length. The holes, 5 + 6 cm in diameter, are made up to 50 m long and with any position.

Then the tendons for prestressed concrete are inserted into the hole. These tendons are prestressed or protected by an oiled pla-

stic sheath inside and afterwards post-tensioned.

In this latter case the steel of the unbounded tendons is protected against the oxidization independently of the external mortar injection reliability. Moreover it is possible to perform the post-tensioning after the external mortar injection and therefore when the masonry has stiffened.

Additives are added to the mortar to prevent shrinkage.

In this manner a local improvement of the crossing masonry is obtained. In fact the fluid mortar saturates the existent spaces between the constitutive elements and the wide hollows unfortunately always present in this particular type of stone masonry.

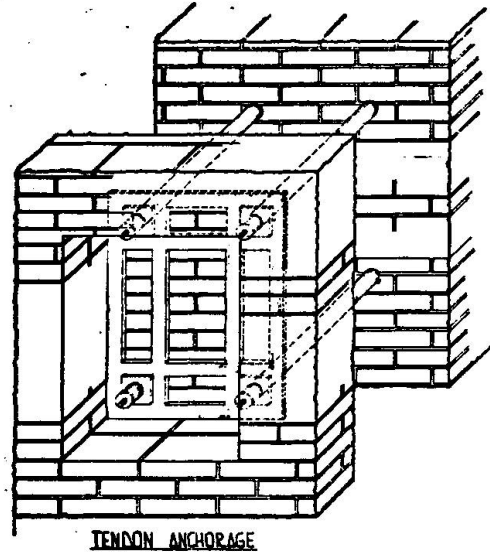

Fig. 1

In order to have a hooped lintol (fig. 1), sewings with a group of four tendons are arranged. Before the tensioning the tendons of the group are stirruped with $\phi 12 + 14$ welded crop-ends, with 150 + 200 cm centres. These stirrups join in a whole the four tendons and play the important role of preventing the transverse vibrations that any tendon may exhibit following the sudden tensile stresses produced by earthquake shock effects.

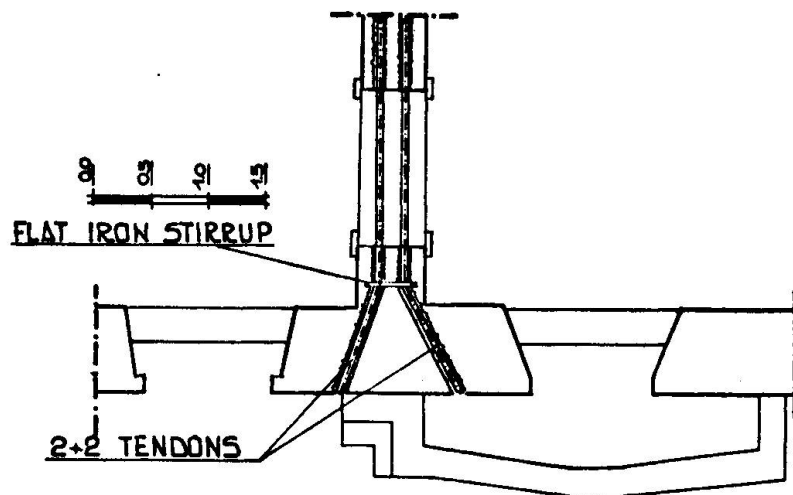

Fig. 2

There is the possibility of changing the direction of the four tendons locally on the condition that the axial simmetry is respected. Particularly the solution of fig. 2 is feasible when a structural element lies in the area of the anchorage of the tendons.

The intersection of bearing walls is propped up with a column-shaped vertical reinforcement firstly to improve the area of the crossing of the level lintols, secondly to effect a better connection between the different floors and finally to inject mortar with additives into the masonry.

In this case the reinforcements are generally made by deformed steel bars which are stirruped every 50 + 60 cm, in the same a way as the lintols.

Repair or anchorage microsewing is arranged on the masonry and on the masonry cornices or friezes where necessary.

The holes, made by chrifters with a drill range 2 + 3 cm, are filled under pressure using mortar with additives after the insertion of deformed steel bars of $\varnothing 6 + 8$. These microsewings are efficacious for stone masonry and particularly the connection of a masonry wall with brick masonry.

Sometimes and for small length (50 + 100 cm) the steel bars are replaced by brass threaded ones in order to avoid a possible attack by atmospheric agents.

Finally it makes use sometimes of tendons, each of them running into the masonry wall alternatively crossing from one face to another (fig. 3). The following results are achieved:

- a greater setting on the skin-masonry;
- a smaller fatigue of the masonry during the drilling stage;
- a hopping effect of the masonry core;
- the possibility of erecting the lintols with prestressed tendons on walls which are not rectilinear.

3.3 Floors

In structural repairs which require radical change, cast-in-situ partially prestressed floor joists with clay-blocks are chosen. In these cases the question is to make suitable correlations between the floors and the walls.

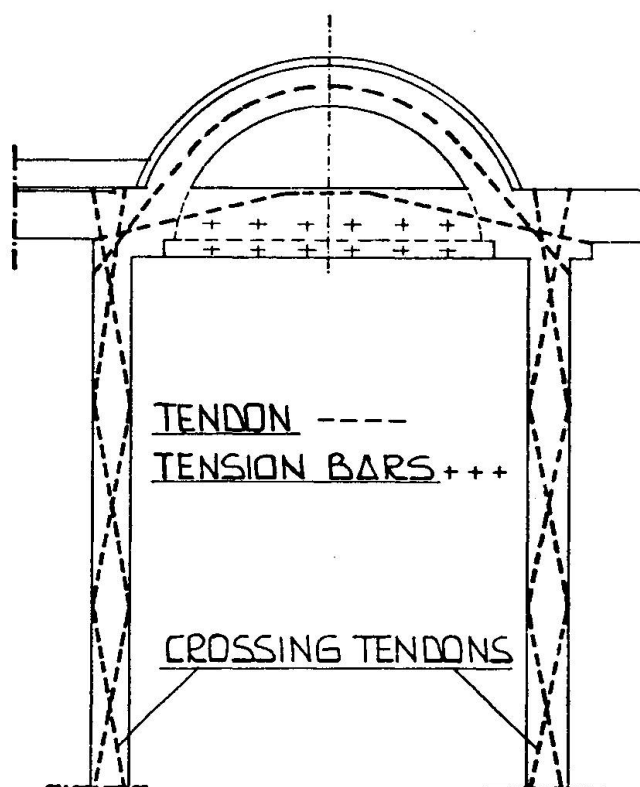

Fig. 3

In the place of the pre-existing wood beam butts, the complete cutting of the masonry to receive a standard reinforced concrete lintol is performed step by step. In the same way as the structural repair to the foundation, during the cutting stage the masonry is supported with casting-embodied jack made by two steel plates connected with a height adjusting rod (fig. 4).

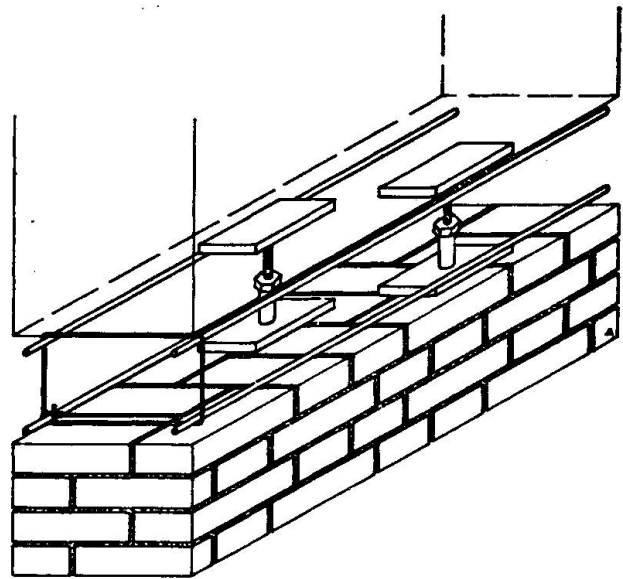

Fig. 4

The casting is done as far as the extrados plane of the slab, then an inclined formwork is arranged for the concrete filling of the hollow that is still in the masonry. This latter part of the casting must be pressurised, carefully vibrated and done using mortar with additives.

3.4 Arches and vaults

The old bracing systems or those which use the ties placed on the extrados, above the crown section so as to hide their presence, are no longer used. Both these devices reduce but do not cancel the harmful effects of the drifts specially when used for rather slender abutments.

It is pointed out that when making a repair to curved elements of historical and monumental buildings it is very difficult to

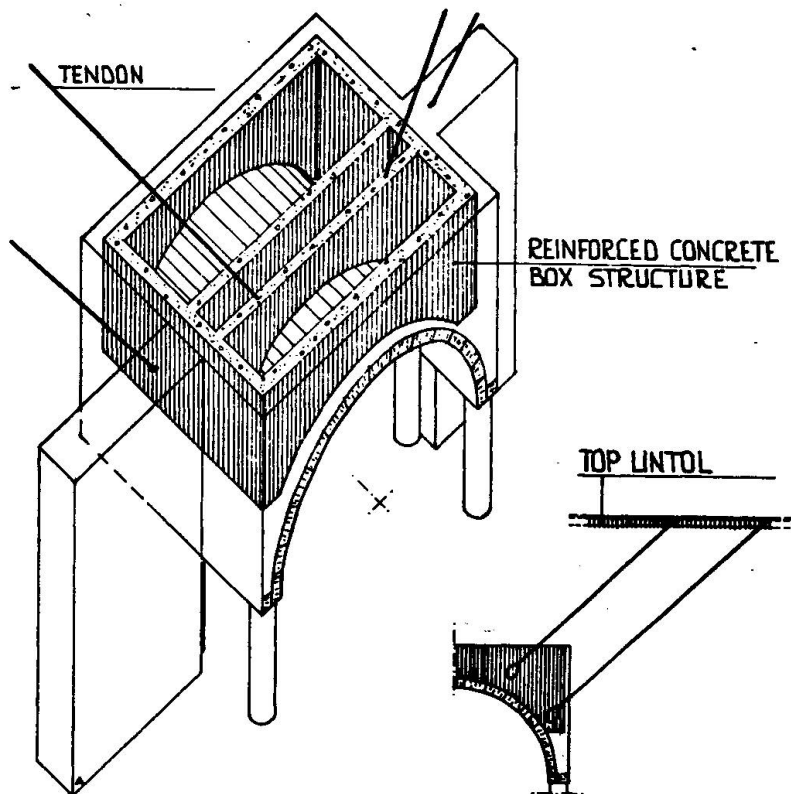

Fig. 5

find single system doing the job. This arises from the following facts: the inadmissibility of visible metallic ties imposed by aesthetic considerations; the heterogeneousness of the structural performances of the elements to be repaired; the generally limited space available above the extrados; finally, the inconsistency of the support points.

Therefore several structural repair patterns are employed. The following appear as most meaningful.

When enough space at the extrados of the arch to be repaired is available a reinforced concrete box-structure is arranged in the inner part of the arch. Several arch quoins are jointed to this box-structure. In the case of fig. 5 the box-structure is jointed using inclined ties to the reinforced concrete lintol placed on the top of the building so as to transfer the load into the more efficient static areas.

In the presence of very small crown space above the extrados, a system of reinforced concrete cantilevers is arranged so as to balance the thrust of the vault, using the position of the overhanging column (fig. 6).

Sometimes the thrust is eliminated using two inclined ties departing from the springer and anchored in the middle of a rigid reinforced concrete beam. This latter is completely independent of the vault and supported on the abutments of the same vault (fig 7).

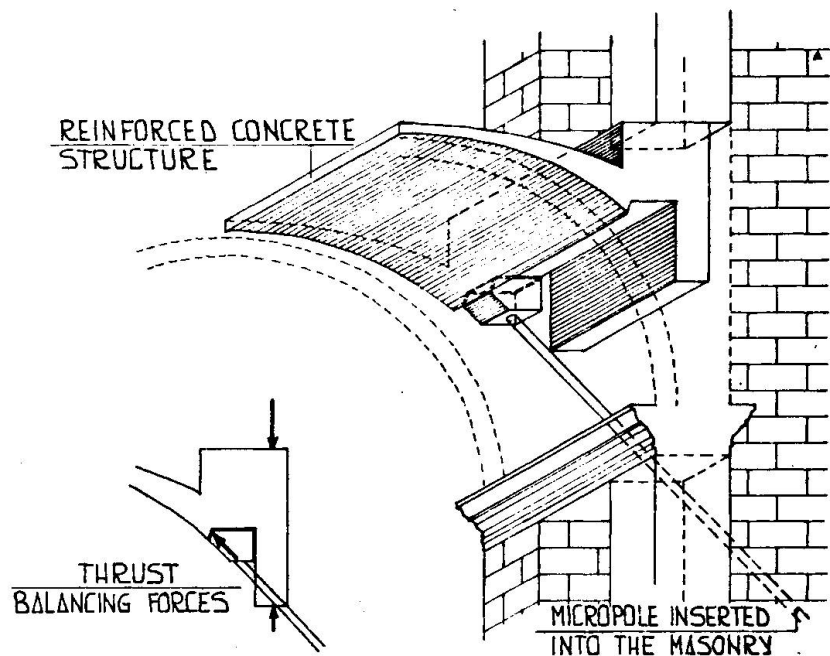

Fig. 6

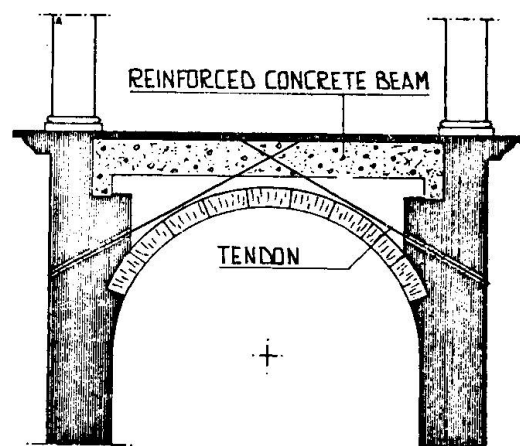

Fig. 7

Non typical structural repair performed on a ogival propless vault deserves a mention. This can be done when the above mentioned techniques and particularly the use of a tie, located in a statically ineffective position for aesthetic reasons, are impractical. In this case the springer pressures should come from two reinforced concrete cantilevers placed at the springer of the vault and arranged with sheathed tendons inserted and tensioned when the casting has stiffened. The tendons fasten the cantilever to a facade-wall efficiently (fig. 8).

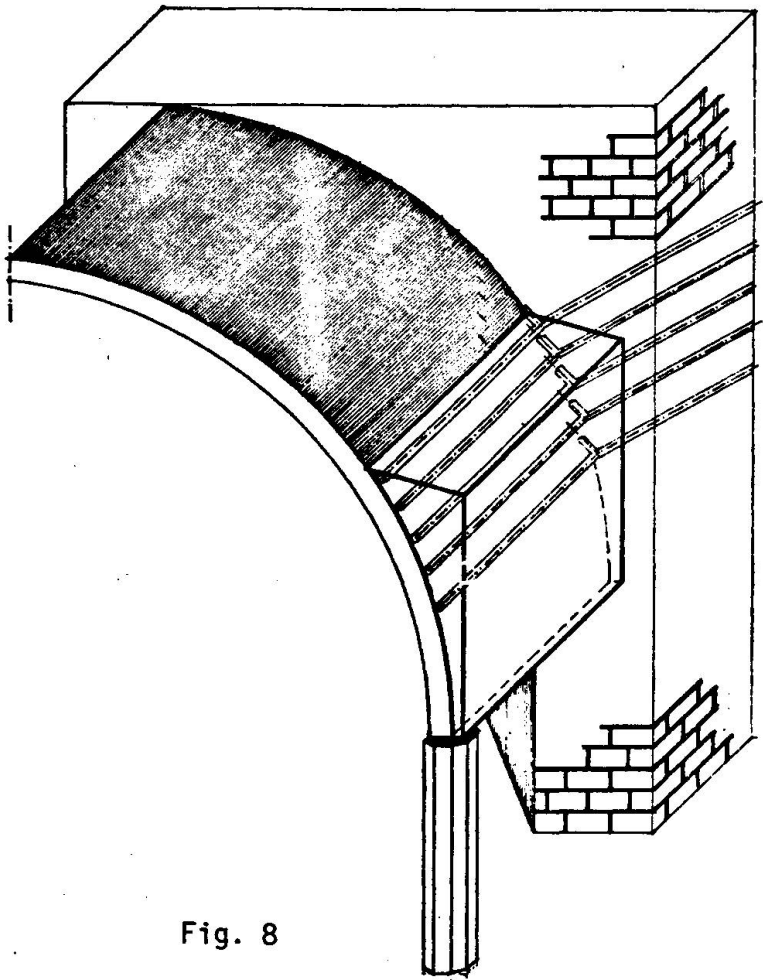

Fig. 8

In the presence of a strain condition produced by an inadequate loading of the curved element (fig. 9), there should be arranged on the extrados artificial massless loads, located at a number of limited points and obtained by tendons tensioned in a suitable way and by screw-jacks embodied afterwards in a reinforced concrete lintol.

3.5 Domes

The analysis for behaviour under static loading required for the structural repair of the domes frequently indicates that the line of pressure comes out of the kernel of the cross section so that, specially near the vertex there arise strained zones. These latter in the primary structural idea, are reduced (never cancelled) by the masonry turrets. Obviously such a device is not feasible as a structural repair especially to hold the entity of the masses which come into play.

Therefore live stresses are to be balanced with the artificial massless loads.

Actually a steel inner-dome made by two elements separated by a joint is arranged. An element is jointed at the bottom to a pre-

stressed concrete ring, the other one is jointed at the top to the vertex of the dome. The joint allows thermal expansions and deformation changes due to shrinkage.

Then a set of steel cables, departing from the top of the dome and separated from the masonry by a truss, loads only the end side of the dome as far as it is necessary for the equilibrium while a forces system which contributes to place the line of pressure in the centre is arranged (fig. 10).

4. CONCLUSIONS

The illustrated structural repairs have been studied so the strengthening structure, as prestressed, is able to collaborate with the

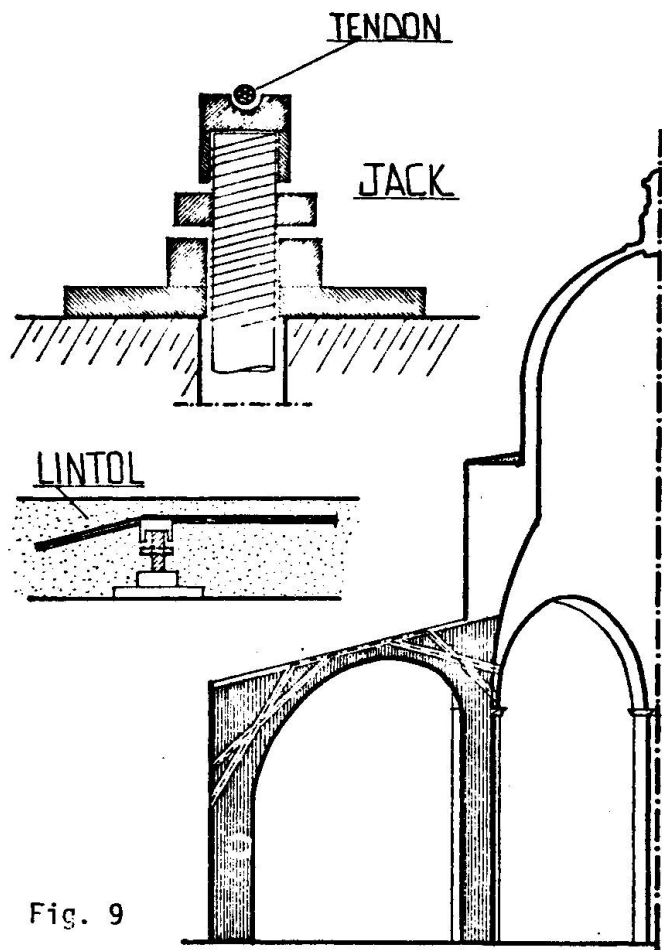

Fig. 9

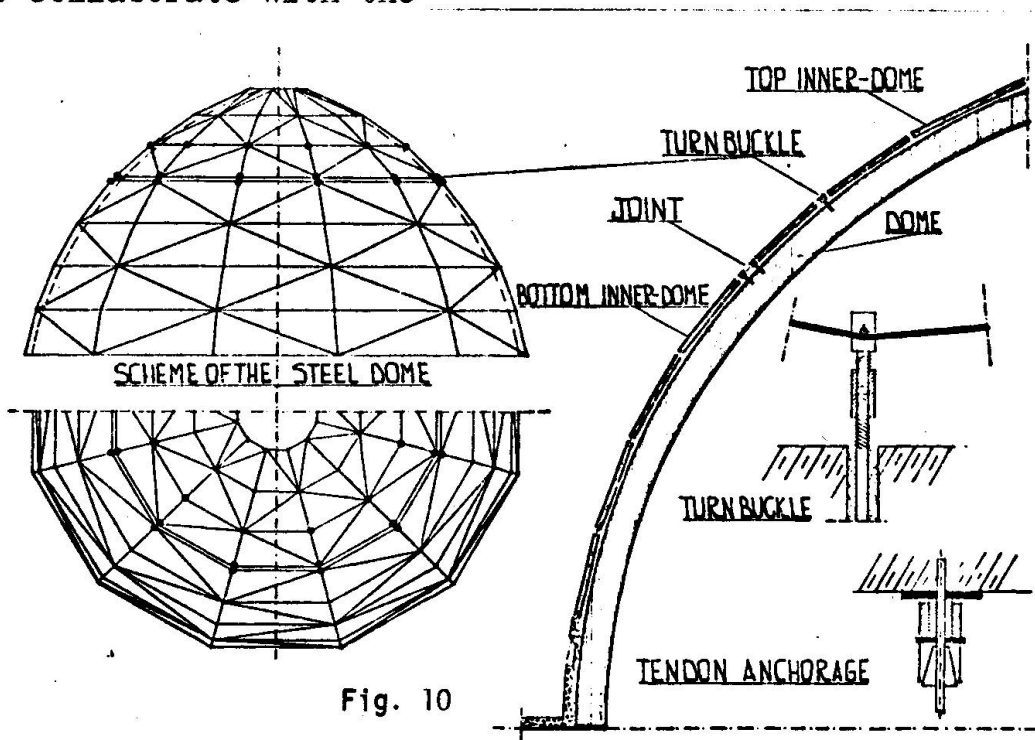

Fig. 10

existant stoneworks right from the beginning.

In this manner structural movements, which are particularly harmful for the masonry structures are avoided.

The architectonic value of the repaired buildings associated with their usage features require non-typical structural repairs generally independent of the costs involved, but carried out to respect and to preserve above all the greatness of the building and, at the same time, to improve its earthquake resistance.

STRENGTHENING OF MASONRY BUILDINGS (+)

by

D. Benedetti and E. Vitiello

Associate Professors, Politecnico di Milano, Italy

SUMMARY

The problem of strengthening buildings made by bricks and stone-work is considered at two principal levels: (a) invention, description and evaluation of various techniques for strengthening; (b) cost-benefit analysis and design methods. Level (a) is introduced in the paper as a survey presentation. Level (b) consists in the statement of the problem of design as an optimization with logical (yes-no) variables. The problem is translated into a graph and solved by a method of critical path.

RESUME

Le renforcement des bâtiments en pierre et/ou briques est considéré à deux niveaux: (a) invention, description et évaluation des techniques. (b) analyse des coût-profit et décisions du projet.

Le niveau (a) est donné par une revue. Le niveau (b) est ici présenté par la formulation du projet dans la forme d'une minimisation à variables logiques. La solution est indiquée par la méthode du parcours critique d'un graph orientée.

ZUSAMMENFASSUNG

Das Problem bezüglich der Verstärkung von Stein- und Ziegel-Bauten ist hier aus zwei Standpunkten betrachtet: (a) Erfindung, Beschreibung und Wertung von verschiedenen Versärkungstechniken; (b) Analyse von den Kosten-Ersparungen und Zeichnungsmethoden. Niveau (a) wird als Quellenverzeichnis dargelegt. Niveau (b) das Problem der Zeichnungsmethoden ist erklärt als Optimierung von logischen Variablen (ja-nein). Das Problem ist einem "graph" gegeben und durch die Methode "critical path" aufgelöst.

(+) Research carried out in the frame of C.N.R.'s Italian Geodynamics Project.

1. INTRODUCTION

In many countries of the world situated in seismic areas various urban settlements include old buildings made up by various techniques and materials among which bricks and stones are more commonly used. Quite often these buildings have a poor resistance against horizontal forces generated by earthquakes. This is due to many factors such as (a) the poor quality of mortars, (b) the inadequate bonds between orthogonal walls, (c) the high in-plane deformability of horizontal diaphragms, what prevents horizontal forces to be transferred to vertical resisting elements, (d) the poor bonds between slabs and walls. An important role is played by functional changes and manipulations which frequently old buildings experienced during their life: this causes either the weakening of bearing walls due to openings not accounted for in the original design or the addition of "new" parts to the buildings which give rise to planar dissymetries which in turn originate torsional effects during the seismic shock.

These elements point out the importance of the problem connected with the definition of strengthening methods for masonry buildings. In the Author's opinion, the problem can be splitted in different stages:

a) Invention, testing, and practical implementation of techniques to add resistance to buildings of the above mentioned type. The following chapter 2 is devoted to a survey of the literature and of the current practice in this field. Attention is paid to the evaluation of the additional resistance that can be obtained by different techniques, although quantitative results are **scarse**.

b) Statement of design methods for strengthening. A decision method in earthquake engineering rests on cost-benefit analysis; refs. [1] , [2] , [3] are examples of this approaches. In Chapter 3 of the present paper, cost-benefit analysis is implemented to deal with practical design. In the case of strengthening old buildings structural decisions to be taken are often quantified by logical rather than by scalar design variables. For example: the design for strengthening a masonry building may deal with the decisions of re-building or not slabs, or/and prestressing or not the wall... while it is not very important to define "to what extent" the new slab must bear or "to what extent" the prestressing should be. The decisions regarding "to what extent" often are not structural variables since they depend on technological and practical constraints. While decisions regarding "the what extent" are expressed clearly by scalar design variables, "to build or not to build" is expressed by a logical (yes-no) variable.

In Chapter 3 the traditional statements of the design seen as minimization problem are adopted. The functions to be minimized contain the cost of strengthening, the non-structural benefits due to the works of strengthening, the expected future monetary damages and the expected number of victims. In traditional cost-benefit analysis the minimization is carried out with respect to continuous design variables. Constrained minimization give rise to the concept of marginal cost, useful to incorporate non monetary aspects of the problem, such as the loss of lives. As it was stated earlier, in this case we have to deal with discrete (yes-no) design variables. As a consequence new minimization techniques have to be implemented. This will be done by representing the design space as a graph and adopting the critical path technique to minimize the object function. In addition the nature of implied variables makes the concept of marginal cost to be no more pregant. Two different uses of cost-benefit analysis may take shape. The first one (sec. 3.2) consists in the determination of the minimum cost of strengthening, considering also expected future damages but ignoring losses in human lifes. The second (sec.3.3) consists in

including the risk to human life as a penalty term. The two corresponding optimal design will bracket the range of reasonable solutions for practical design. Ref. [2] shows that in some instances this range is very narrow. Thus the use of the two above procedures allows to identify a sort of "feasible" region for strengthening design.

2. MAIN STRENGTHENING TECHNIQUES

Basically strengthening operations carried out on old buildings aim to give rise to a box-type structural behaviour. Continuous vertical elements need thus to be properly connected each other and to horizontal diaphragms which in turn have to transmit horizontal forces to resisting vertical walls proportionally to their stiffnesses. Moreover an appropriate distribution of shear walls has to be obtained in such a way that torsional effects are avoided.

These targets may be pursued in various manners: the essential features of the main techniques which are usually adopted will be shortly described in what follows.

2.1 Vertical plates

The basic idea of this procedure is to overlap to original walls new continuous resisting vertical structures. This can be made in several ways, i.e.:

(1) With reinforced concrete plates laid on the two sides of the wall and sewed together by transversal steel passing through the wall. These plates are usually more than 5 cm. thick, it turns out that the original walls become considerably bigger and heavier.



FIG. 1 A

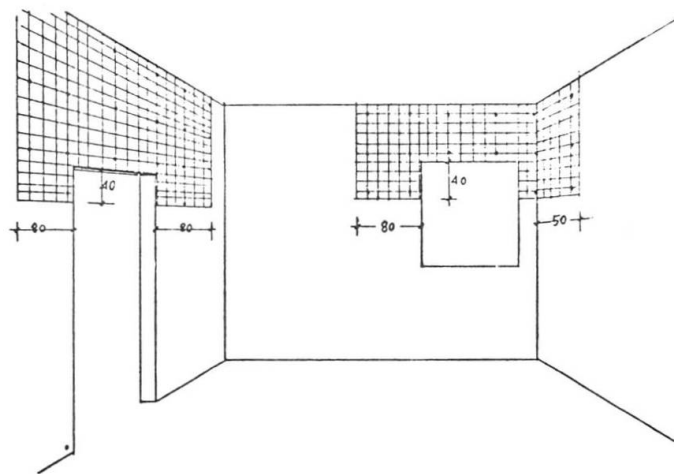

FIG. 1 B

A development of this technique [7] consists in the use of steel nets with modular shape of 15 X 15 cm. placed on both sides of the wall and mutually connected through the wall (fig.1). Concrete is spread over the net thus obtaining vertical plates about 3 cm. thick. A difficulty connected with the use of vertical plates lies in the poor continuity between the old and the "new" wall due to incomplete adhesion between the pre-existing and strengthening structure and due to shrinkage.

(2) These difficulties may be somehow overtaken by the use of gunite (or shotcrete). This is a method of applying a cement sand mix with an impact which assures a good bond. It is a mix with a rather good water-cement ratio for good strength and minimum shrinkage. Moreover this method of application provides

excellent freedom of shape. A 1.5 - 2 cm. thickness may be obtained. The use of gunite requires high-pressure equipments, what results into practical limitations of the method especially when one has to deal with walls of a very poor quality.

2.2 Horizontal runners

A traditional strengthening method consist in the use of horizontal r.c. bonds at roof, lintel and plinth level. Under a structural point of view such runners improve bending characteristics of walls transverse to the direction of the horizontal force by supporting them at fixed points and reducing bending tensions in the horizontal plane which occur when transverse walls behave as slabs due to seismic action. Good results may be obtained by coupling horizontal and vertical r.c. runners with appropriate connections among them. In this way a sort of framed system is achieved which exhibits a good resistance to seismic forces. This technique however produces strong changes in the original look of the building and this fact may constitute a restriction to its use.

2.3 Steel reinforcement

Reinforcing bars may be inserted in drilled cores which are then sealed by cement grouting.

This technique may achieve excellent results and shows the merit of not producing changes in the original look of the building. However drilling may take place successfully only in systems which already have enough strength: when the quality of the building is very poor it is advisable to proceed to an improvement of quality of the walls (e.g. by grouting) before inserting bars.

Steel reinforcement may be used both to achieve a bond between orthogonal walls and to increase the lateral of single walls (figs. 2-3-4). In the first case diagonal drills are performed on either vertical edges of the two walls. As far as the second problem is concerned different possibilities of placing reinforcement exist. In ref. [4] three different solutions were examined with reference to simple models (see fig.5) i.e. steel at vertical corners (fig. 5a), steel at jambs (fig. 5b) and steel both at vertical corners and jambs (fig. 5c). Experimental ultimate loads (defined as the load causing the first crack in each pier) show the following ratios in the three cases stated above:

$$(UL)_a : (UL)_b : (UL)_c = 1:0.89:1.56$$

As far as ductility is concerned tests show that when reinforcement exists anywhere in a pier this can take additional shear force after cracking. This does not happen with unreinforced wall, where failure is sudden.

In refs. [5] and [6] tests carried out at Roorkee school on models of brick buildings strengthened in various ways are reported. The following table shows the strengthening methods which have been investigated and the improvement of lateral resistance. Reference is made to the lateral resistance of the unreinforced house.

TABLE 1

Type	Ultimate Load
1) Unreinforced house	1
2) With lintel band	1
3) Lintel and plinth bands	1.25
4) Vertical steel at corners	2.95
5) " " at jambs	1.4
6) " " and corners	4.1
7) " " at corners + lintel band	3.2
8) " " at jambs + lintel band	1.6
9) " " at jambs + corners + lintel band	4.4

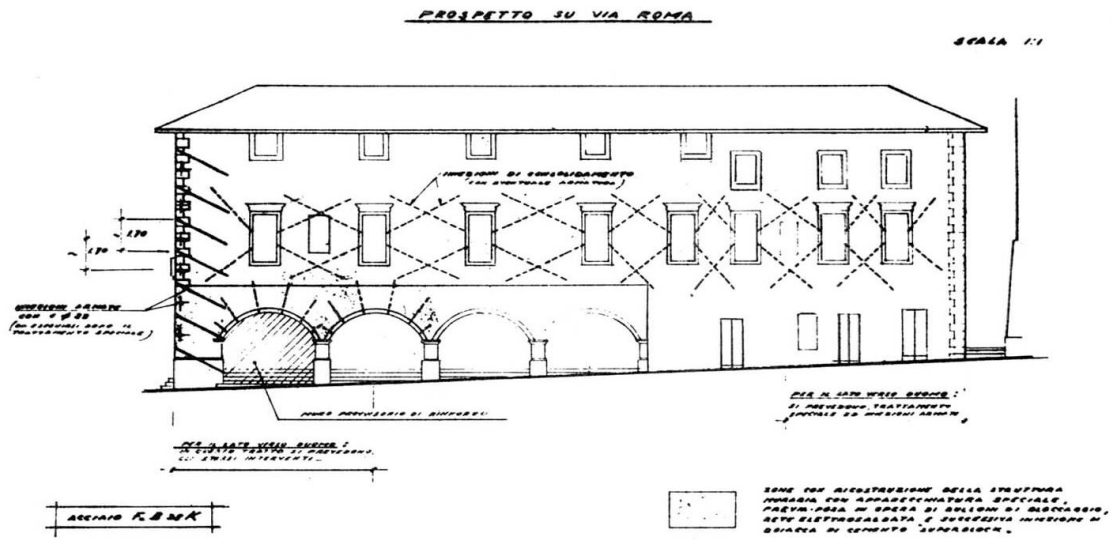

FIG. 3

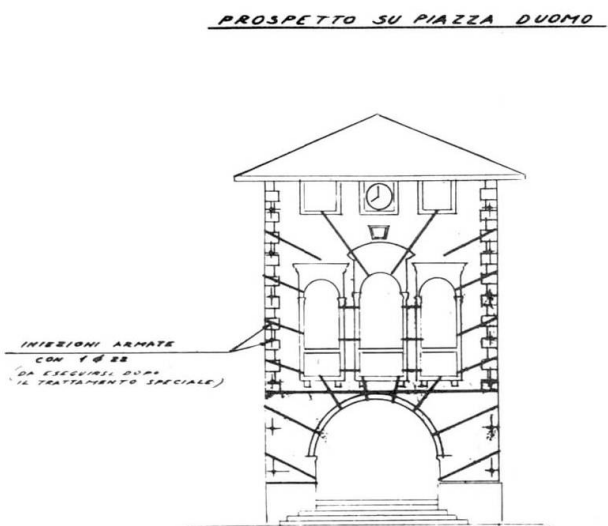

FIG. 2

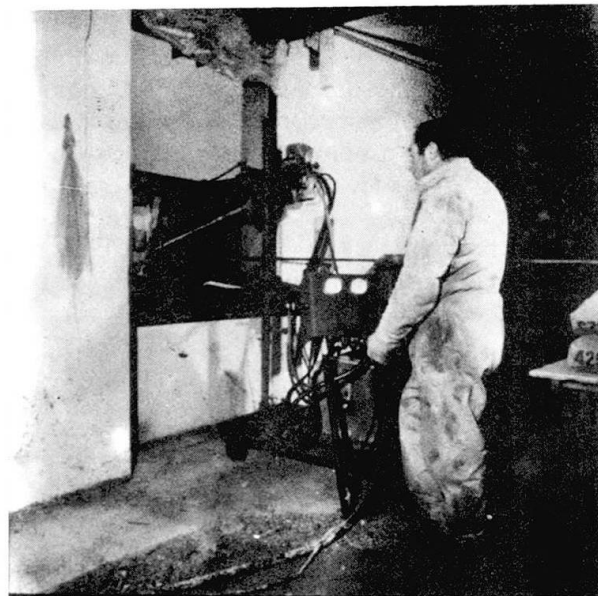

FIG. 4

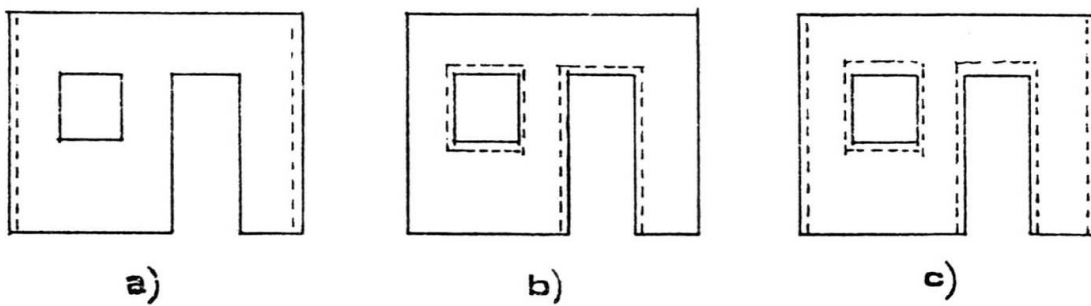

FIG. 5

Comments to above table reported in [5] point out that horizontal steel at lintel level does not contribute to lateral resistance, since failure occurs at the plinth level. This feature is confirmed by the comparison of the cases (4) and (5) with the cases (7) and (8) respectively which differ from the previous ones due to the lintel band whose effect towards lateral strengthening is seen to be of the order of the 12% as a minimum.

This respect it is worth noting however that the insertion of lintel bands improves the connection between orthogonal walls. In the case of originally poor tie between such walls horizontal steel may result in an increasing of lateral resistance. Moreover above results make clear the considerable importance of vertical steel. Steel at jambs is relatively less important with respect to the ultimate load: the overall resistance of the structure is however increased due to the better defense of corners resulting from the reinforcement.

2.4 Prestressing

Prestressing of walls may be obtained by the use of vertical (fig.6) and horizontal (fig. 7,8) tendons which can be either inserted in drilled cores or placed on both faces of the wall. In the case of vertical rods they are threaded into foundations anchorages. Horizontal tendons are connected to vertical edges of walls by means of steel plates which distribute pressures over a portion of wall. Usually bars of 14-18 cm. of diameter are employed to this aim. It should be noted that the use of prestressed tendons may produce changes in the original statics of the building which might not be suffered by poor quality structures; it is thus advisable to previously undertaken strengthening operations which enable structure to withstand tendons. In some instances horizontal tendons are lied down on slabs connecting opposite walls or corners (fig.9). The basic aim of prestressing is to induce into the wall a biaxial state of compression in order to reduce tensions due to lateral load. Note that brickwork is especially suited for prestressing due to its limited creep and shrinkage characteristics [9]. In ref. [8] the following expression is given to represent the increase h of lateral resistance of a prestressed wall by means of horizontal rods:

$$\frac{\left(\frac{\sigma_o - \sigma}{3 \tau_K} + 1\right)^2 - \left(\frac{\sigma_o - \sigma}{3 \tau_K}\right)^2}{1 + \frac{3}{2} \frac{\sigma_o}{\tau_K}} = h^2$$

being:

σ_o = average vertical compression stress

σ = horizontal compression stress

τ_K = ultimate shear stress with no vertical overloaded on the wall (self weight only).

Tests reported in [8] shown an increase of lateral resistance which is bigger for lower values of τ_K (poor quality wall).

2.5 Grouting

Intrusions of cement grout into wall interstices is frequently used. This technique shows the advantage of producing no change in the original look and in the original statics of buildings. For this last reason it is frequently employed before the use of other strengthening techniques (such as drilling or prestressing) in order to assure enough strength.

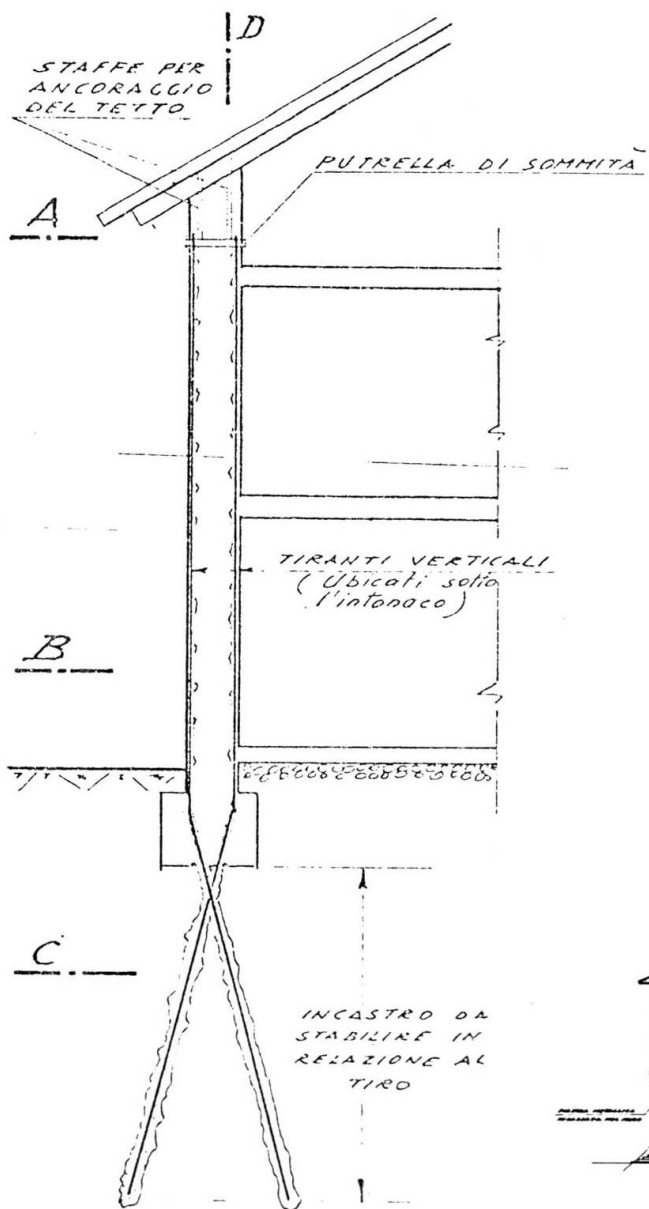

FIG. 6

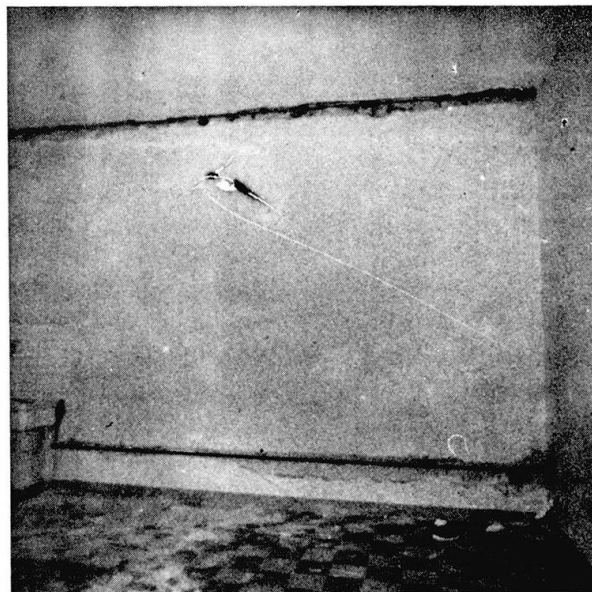

FIG. 7

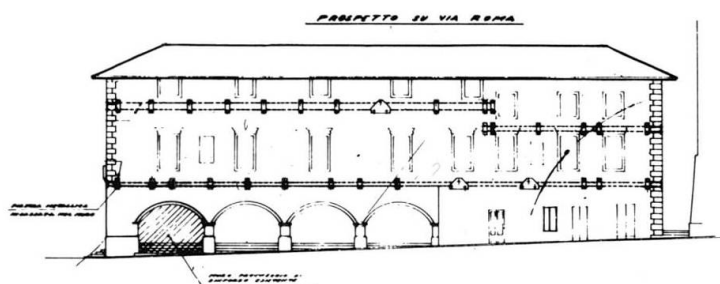

FIG. 8

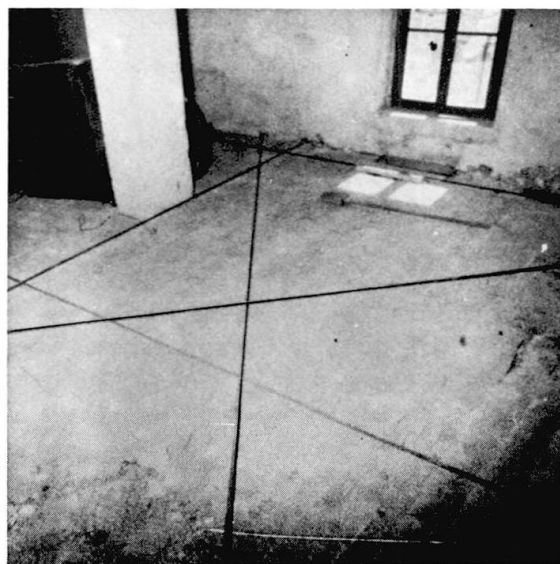

FIG. 9

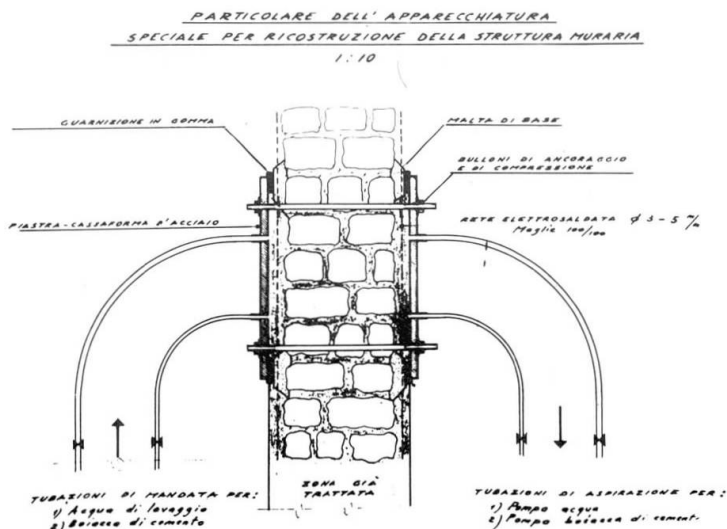

FIG. 10



FIG. 11

The efficiency of grouting is conditioned by the initial quality of wall, the type of cement mix used and by level to diffusion within the wall of the mixture. The last two factors play an important role in the determination of the overall cost of the operations.

Moreover grouting is not very effective with respect to the improvement of connections between orthogonal walls. Intrusions are often performed by drilling 4 cm. diameter cores with a spacing of 40-100 cm. into the wall (see fig. 10-11). Intrusions are made at a low pressure (3 - 4 Kg/cm²)

level so that exceeding water may be properly drained. Under a broad point of view it may be stated that by grouting the wall, which quite often is of a poor quality, may achieve a lateral strength of the same order of a well-made unreinforced wall. If an increase of lateral resistance is desired, as it may happen if a seismic provision is enforced to old buildings, grouting has to be coupled to other strengthening methods. Tests reported in ref. [8] show that the poorer in the wall the greater increase in lateral strength may be obtained.

3. DESIGN DECISIONS FOR STRENGTHENING

A cost-benefit statement of the problem of design deals with the following four items:

i) the cost of the strengthening:

$$C = \sum_{i=1}^n C_i \quad (1)$$

where C_i is the cost for the i -th type of strengthening work. For instance: C_1 is the cost of re-building the slabs, C_2 the cost of grouting, etc... In the following C and C_i are costs per year, and can be related to an unique investment via the concept of constant investment rate (or amortization)

ii) The benefit derived from each strengthening work, with the exception of benefit for structural (seismic-proof) consequences:

$$B = \sum_{i=1}^n B_i \quad (2)$$

For instance: B_1 is the benefit for the new slabs and floor, B_2 is the benefit for a water-proof external wall, etc... A criterion can be to evaluate B_1 in terms of variation in rentability. Again B_1 is referred to one year.

iii) The future monetary damages due to earthquakes. Assuming the intensity of the earthquake (such as peak ground acceleration) as an independent variable, a damage function of the type of fig. 12 for a single building is often [3] assumed. The value \bar{a} is the ground acc. corresponding to collapse of the building, \bar{a} marks the initial cracks, \bar{C} the monetary value of the building (in yearly units) and ϕ is a factor of amplification due to the event "collapse" with reference to "total unserviceability" of the building.

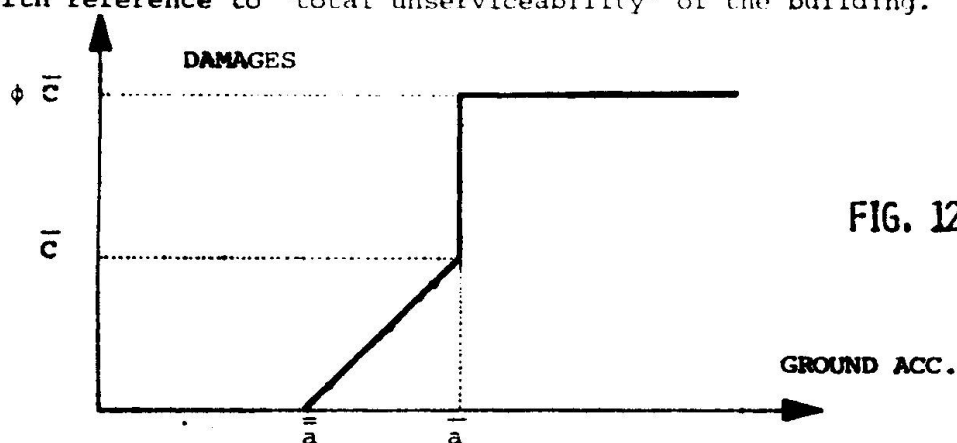

FIG. 12

In the present case $\bar{C} = C_p + C$, where C_p is the yearly cost of the building before strengthening. Ref. [3] shows that the future monetary damages can be expressed by

$$D = (1 + f) \cdot \phi \cdot \bar{C} \cdot N(\bar{a}) \quad (3)$$

where $N(\bar{a})$ is the expected number of earthquakes per year having a peak ground acceleration greater than \bar{a} ; f is a parameter depending basically on the ratio \bar{a}/a . See ref. [3] for analytical expressions.

iv) The expected number of victims per year can be expressed by

$$V = \epsilon \cdot \bar{n} \cdot N(\bar{a}) \quad (4)$$

where \bar{n} is the number of people living in the building and $\epsilon < 1$ is a factor taking into account absence of inhabitants, warning....

3.1 Statement of the optimization problem

In the literature the design problem derived from cost benefit-analysis is stated in different ways:

$$\min (C - B + D + \mu V) \quad (5)$$

$$\text{or} \quad \min (C - B + D); \quad V \leq K_1 \quad (6)$$

$$\text{or} \quad \min (V); \quad (C - B + D) \leq K_2 \quad (7)$$

The relationships among (5), (6), (7) are discussed in ref. [2], [3], together with the meaning of μ . Minimization is carried out with respect to the design variables.

In the present case, as pointed out in the introduction, the design variables are expressed more properly by "yes-no" type decision. Therefore any particular point of the design space corresponds to a particular combination of

"presence" or "absence" of indices i in the terms C and B . A particular design corresponds to a certain value of the collapse acceleration of the building which is expressed in terms of the same indices i occurring in C and B :

$$\bar{a} = a_p \cdot \prod_{i=1}^n r_i \quad (\Pi = \text{serial product}) \quad (8)$$

where a_p is the collapse acceleration of the building before strengthening and

$$r_i = 1 + p_i \quad (9)$$

where $p_i = 0$ if the i -th reinforcing has not be included in the design.
 p_i is the percentage of additional resistance due to the i -th work of strengthening included in the design.

It must be noted that the format of eq.(8) is suggested by table 1, sec.2.3, however other formats are compatible with the sequel. The evaluation of a_p can be a very serious problem. Since it is outside the scope of this paper, reference is made to the survey of refs. [10][11], and to the methodology discussed in ref. [12].

In conclusion: knowing the seismicity $N(a)$, once \bar{a} is evaluated through (8), a value of D and V can be also associated to it, through (3) and (4).

The expression appearing in (5), (6), (7) can now computed in principle. Therefore the constrained (6), (7) or unconstrained (5) minimizations can be carried out, provided μ , K_1 , K_2 are given.

In what follows a technique to solve above optimizations is shown.

3.2 The minimum-cost strengthening

As stated in the introduction, the minimum cost design is such that

$$\min W = \min (C - B + D) \quad (10)$$

This corresponds to the problem (5) with $\mu = 0$ and to problem (6) with $K_1 = \infty$.

In order to solve problem (10) let us draw a graph as in fig.13. The points of the graph are: a) a zero design corresponding to the not strengthened existing building, b) a row of points each corresponding to one strengthening work, (three in the example of fig. 13), c) other rows of points corresponding to works to be done in alternative: in the example of fig. 13 horizontal tendons into existing slabs is alternative to the complete re-building of the slab.

The arcs between the points are such that any point is connected to zero and to all the following points, with the exception of column-arcs (arc 2-3 in the example). Any design can be represented by a path starting from zero and ending to any point. For example, the path 0-2-4 means a strengthening with horizontal tendons and vertical prestressing.

The minimization problem is a problem of critical path: find the shortest way "d" from zero to any point. The length $d_{i,j}$ is defined as

$$d_{i,j} = W_j - d_i$$

where d_i is the minimum value of $(C - B + D)$ when only the works from zero to i are considered as design variables and W_j is the value of $(C - B + D)$ when the work j is added to such optimum design.

The above statement and eqs.(3)-(8) point out that the lengths of all the arcs

cannot be calculated before the minimization (like in the classical critical path problem [13]). This is due to the nonadditive nature of the term D in eq.(10), see eqs.(3) and (8).

On the other hand, since the classical algorithm for critical path proceeds backwards, the classical minimization procedure can be used and the length $d_{i,j}$, calculated at any step. In fig.13 the steps for the sequential optimization are written for the example given. In general:

$$d_{0,i} = C_i - B_i + D_{0,i}$$

where $D_{0,i}$ is the function D (eq.(3)), with

$$\bar{a} = a_p \cdot r_i$$

$$\bar{C} = C_p + C_i$$

also

$$d_{i,j} = C_j - B_j + D_{i,j}$$

$$D_{i,j} = D_j - D_i$$

D_i is the function D , eq.(3), with $\bar{a} = \bar{a}_i$ and $\bar{C} = \bar{C}_i$ corresponding to the critical path design from zero to i ; D_j the same with

$$\bar{a} = \bar{a}_i \cdot r_j$$

$$\bar{C} = \bar{C}_i + C_j$$

It is useful to take record of the values \bar{a}_i , \bar{C}_i at each step, as fig.13 shows.

The recursive relation is:

$$d_i = \min \{ d_{0,i} ; \min_j (d_j + d_{j,i}) \} \quad (11)$$

where j ranges over all the arcs incident in point i .

The critical path is obtained as the design for which

$$d = \min_i \{ d_i \} \quad (12)$$

where i ranges over all the points.

3.3 Design including non monetary damages

We refer now to the general cases of eqs.(5), (6), (7). Ref. [2] defines μ as the "maximum price the community is willing to pay in order save one life", and it is suggested to evaluate it by considering the other (rather than earthquake-induced) risks that the community has to face.

In the case of strengthening, μ can be assumed to be equal to the same value associated to the definition of the seismic coefficient for new buildings. When μ is given as a number, the solution of the problem (5) can be obtained by the same technique of problem (10). The only change consists in the addition of one term μV (via eq.4) in the computation of d_i , $d_{i,j}$...Indeed we have still a problem of unconstrained minimization.

Ref. [2] points out that in some instances the design is rather insensible to

changes in μ : therefore it can be advisable first to solve the problem of sec. 3.2 ($\mu = 0$) and then the problem (5) with a very large μ (some million dollars). The two optimal designs will bracket the reasonable design solution.

In ref. [14] the solution of the problem for strengthening and replacement of building in urban areas produces an optimal value for the design collapse acceleration \bar{a}^* of the buildings to be strengthened. If this result is available, it may be taken into account in the problem of sec. 3.2 . The only difference lies in the minimization of eq.(12) where only the d_i for which $\bar{a}_i \geq \bar{a}^*$ must be considered.

It is also clear that problem (6) can be solved by dropping the terms d_i (in eq.(12)) for which $\varepsilon \bar{n} N(\bar{a}) > K_1$.

Problem (7) too can be solved by a similar technique.

4. CONCLUSIONS

The nature of the problem of strenghtening requires, as it has been shown, that structural choices pass through a minimization with discrete design variables. The techniques of solution are available and are presented and worked out for this particular problem herein.

Technical inputs to this problem, which have been outlined in chapter 2, are however rather scarce and need further research. The present paper points out the kind of experimental and theoretical information which need to be assessed for a rational choice of a strengthening design.

5. ACKNOWLEDGEMENTS

The research has been sponsored by C.N.R. Thanks are due to ICOS, Milan, for supplying the picture of chapter 2 .

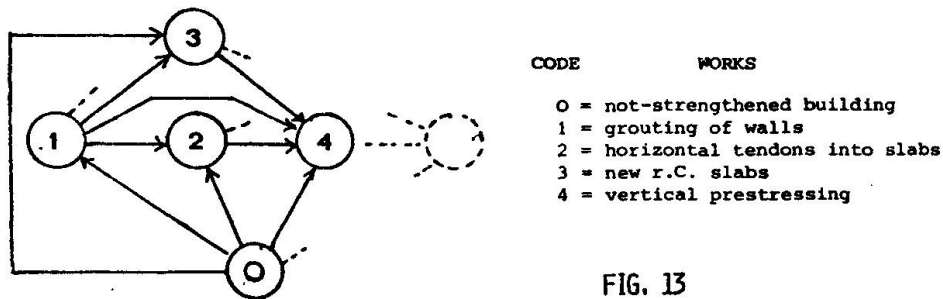

FIG. 13

d_i	path	C_i	\bar{a}_i
$d_1 = d_{0,1}$	0 - 1	$C_p + C_1$	$a_p \cdot r_1$
$d_2 = \min \{d_{0,2} ; (d_1 + d_{1,2})\} = d_{0,2}$	0 - 2	$C_p + C_2$	$a_p \cdot r_2$
$d_3 = \min \{d_{0,3} ; (d_1 + d_{1,3})\} = d_1 + d_{1,3}$	0 - 1 - 3	$C_p + C_1 + C_3$	$a_p \cdot r_1 \cdot r_3$
$d_4 = \min \{d_{0,4} ; (d_3 + d_{3,4}) ; (d_2 + d_{2,4}) ; (d_1 + d_{1,4})\} = d_2 + d_{2,4}$	0 - 2 - 4	$C_p + C_2 + C_4$	$a_p \cdot r_2 \cdot r_4$
$d = \min \{d_1, d_2, d_3, d_4\} = d_4$	0 - 2 - 4		

REMARK: in the above table possible solutions (and relatqd paths, \bar{C}_i, \bar{a}_i) are given as a matter of example.

REFERENCES

1. NEWMARK, K.M., ROSENBLEUTH, E., Basic Concepts in Earthquake Resistant Design, in Fundamental Earthquake Engineering, Prantice Hall Inc., 1971, pp.449-475.
2. GRANDORI, G, Seismic Zoning as a Problem of Optimization, Proc.2nd Int. Conf. on Structural Safety and Reliability, Munich, 1977, Werner Verlag, Dusseldorf.
3. BENEDETTI, D., VITIELLO, E., Structural Optimization of Seismic Protection, ISTC, Techn. Rep. N.35, Politecnico di Milano, 1974.
4. KRISHNA, J., CHANDRA, B., KONUNGO, S.K., Behaviour of Load Bearing Brick Walls during Earthquakes, Proc. III Symp. on Earth. Eng. Roorkee, 1966.
5. KRISHNA, J., CHANDRA, B., Strengthening of Brick Buildings against Earthquake Forces, Proc. III World Conf. on Earth. Eng. , New Zealand, 1965.
6. KRISHNA, J., CHANDRA, B., Strengthening of Brick Buildings in Seismic Zones, Proc. IV World Conf. on Earth. Eng. , Chile, 1969.
7. THOMPSON, C.J., Repair of Buildings damaged by the 1969 Boland Earthquake, Proc. V World Conf. on Earth. Eng. , Rome, 1973.
8. TERCLJ, S., Metodi di consolidamento a loro effetti, Quaderni CRAD, Udine, taken from Rep. Zadovza Raziskavo Materiala in Konstrinki, Ljubliana, 1976.
9. CAPPI, A., CASTELLANI, A., GRANDORI, G., LOCATELLI, P., Strengthening and Repairing of Masonry Walls damaged by Shear Actions in their own Planes, V world Europ. Conf. on Earth. Eng. , Istanbul, 1975.
10. MAYES, T.L., CLOUGH, R.W., State of the Art in Seismic Shear Strength of Masonry, An Evaluation and Review, EERC Rep. N.75-21, Berkeley, 1975.
11. MAYES, R.L., CLOUGH R.W., A Literature Survey; Compressive Tensile, Bond and Shear Strength of Masonry, EERC Rep. N.75-15, Berkeley, 1975.
12. MAYES, T.L., OMOTE, CHEN, CLOUGH, R.W., Expected Performance of U.B.C., Designed Masonry Structures, EERC Rep., N.76-7.
13. GUE, R.L., THOMAS, M.E., Mathematical Methods in Operations Research, Mc Millian, London, 1968, Chap.9.
14. BENEDETTI, D., VITIELLO, E., Optimal Aseismic Structural Standards for the Replacement of existing Building, to be published in Engineering Optimization, Vol.3, N.4, 1978.

Leere Seite
Blank page
Page vide

**A Way to Increase the Resistance
of Supporting Structures that are Already Built
Against Seismic Forces**

by

Kleon MARINAKIS
President of the
Hellenic Institute for the Application of Science
Athens, Greece

SUMMARY

The object of this paper is to describe the methods used in Greece by the Hellenic Institute for the Application of Science in order to increase the resistance of structures that are already built, against seismic forces. The technique proposed and used by the Hellenic Institute is thoroughly described and illustrated by Fig. 2, 8, II, I2 and I3.

RESUME

Le but de ce papier est de décrire les méthodes pratiquées en Grèce par l'Institut Hellénique pour l'Application de la Science pour augmenter la résistance que les constructions déjà bâties peuvent présenter aux effets sismiques. Ces techniques sont illustrées par les Figures 2, 8, II, I2 et I3.

ZUSAMMENFASSUNG

Der Zweck dieser Veröffentlichung ist zu geben eine Beschreibung der Verfahren des Griechischen Instituts für die Anwendung der Wissenschaften, die in Griechenland für die Verstärkung alten Gebäude gegen Erdbeben benützt sind. Der Verfasser beschreibt ausführlich die Technik zur Verstärkung, die im Abbild 2, 8, II, I2 und I3 dargestellt ist.

THE THINGS THAT WE MUST DO IN ORDER TO STRENGTHEN
OLD STRUCTURES AGAINST SEISMIC EFFECTS

1) We make the structures lighter in weight and the heavy masses un-
touchable by seismic effects.

The first thing to do is to make the structure lighter in weight. There-
fore all heavy masses that can be transported in order to be brought to
rest directly upon the ground in the ground-floor, should be transported
there.

Examples: 1) the bulky archives of big companies and public Services
must be transported to rest directly upon the ground ; 2) all useless
massive objects accumulated in garrets of old houses must be removed from
there; people might heap them safely in the basement; 3) heavy stone pla-
tes covering roofs of houses built with light walls and light floors, must
be replaced by light clay-tiles.

The next thing to do is to free the horizontal motion of the supporting
structure of the building from any opposition by heavy masses connected
with it. This point is of particular importance, because we do not suggest
any removal of heavy masses from the actual position they occupy now in
the building; but we suggest to let these masses stay where they are and
make them untouchable by seismic effects.

This is done in the following way:

.- The heavy mass does no more rest directly upon the supporting slab
that is rigidly connected with the supporting structure as shown in fig. 1
but it is brought to rest upon a plate that rests upon the antiseismic
filter; the antiseismic filter rests upon the supporting slab that is ri-
gidly connected with the supporting structure as shown in Fig. 2. In this
way the opposition presented by the heavy mass to the motion of the sup-
porting slab is as small as we wish it to be. For simplicity's sake let us
say that it presents no opposition at all to the motion of the supporting
slab. This means that the supporting slab is free to move beneath this
heavy mass; the heavy mass does neither oppose nor follow this motion; it
remains motionless. Therefore, the inertia of this mass is not waked up;
so, it exerts no seismic force upon the supporting slab, no seismic force
upon the supporting structure.

Numerical application: We sup-
pose that the weight of the
supporting structure is 150 t,
the weight of the heavy mass
is 50 t, and the acceleration
of the ground is $e = 0,06.g$.

Then the total seismic thrust

resisted by the columns of the ground-floor in the structure shown in
Fig. 1 is $H_1 = 0,06 \times (100 + 50) = 9t$; the total seismic thrust resisted by
the columns of the ground floor in the structure shown in Fig. 2 is
 $H = 0,06 \times (100) = 6 t$.

When the supporting structure is elastically deformable to a sufficiently
large extent as is normally true for the upper floors of multistory
buildings supported by reinforced-concrete, prestressed-concrete or steel
framed structures, then the motion of the slab that supports the heavy
mass under consideration is not very rapid. Therefore, elastic bodies keep
their elastic properties in front of the corresponding seismic effects.
For that reason, in that case we might use "NEOPRENE" or any other ade-
quate "elastomer" instead of the antiseismic filter. So: we introduce an
adequate layer of elastomer between the supporting slab and the plate,
and bring the heavy mass to rest upon this plate. We calculate the hori-
zontal shearing force induced in this layer by the corresponding
stretching, which is equal to the expected amplitude of the seismic mo-
tion of the supporting slab.

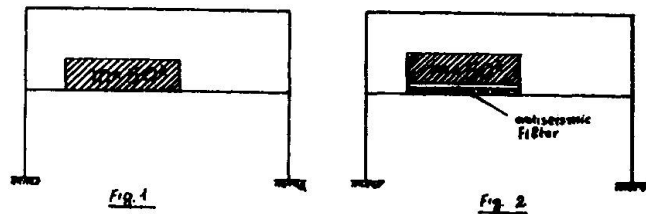

When it is too difficult to estimate this amplitude, we make the following calculation: A force H acting over the elastomer-layer produces the deformation (s); it is $H/K = s$; whence we obtain $K = H/s$; then we write the equation $\ddot{w}.m - K.(x-w) = 0$. For the motion of the ground we admit the equation: $\ddot{x} = e$. We also admit that the supporting slab follows exactly the motion of the ground; then it is: $x = e.t^2/2$ and the differential equation for the motion of the mass becomes:

$$\ddot{w}.m + w.K - \frac{e.K}{2}.t^2 = 0 \text{ which is governed by the limit conditions:}$$

for $t=0 : w = w' = \ddot{w} = 0$; and it is true in the very small interval $0 \rightarrow t$.

For an approximate solution we use the expression: $w = f.t^3 + j.t^4$ because it satisfies the limit conditions. Then we have: $\ddot{w} = 6.f.t + 12.j.t^2$ and we obtain $w \approx 3.e.K.t^4/24.m$ and $H = K.w = 3ek^2t^4/24m$. Of course, we have to select the largest value of t ; this is an estimation. Then we have the value of the seismic thrust produced by the mass m . This is the seismic force with which the mass m will act upon the supporting structure.

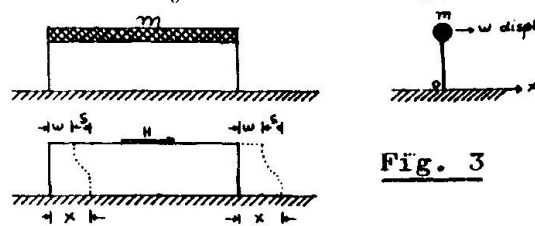

Fig. 3

The use of the antiseismic filter or of elastomer-layers in order to isolate heavy masses from the supporting slabs and make them largely untouchable by seismic effects, is a very simple and absolutely efficient technique. People living in seismic zones or working in the building business in seismic zones, should be familiar with this technique.

It seems to me that the following suggestion might help these people in their arguments:

Let us consider the house shown in Fig. 4. The weight of the supporting structure (i.e. of the reinforced-concrete frame) is $W = 50t$; a heavy mass resting directly upon the supporting slab weighs $20t$. Therefore the total seismic thrust acting upon the columns of the ground floor is

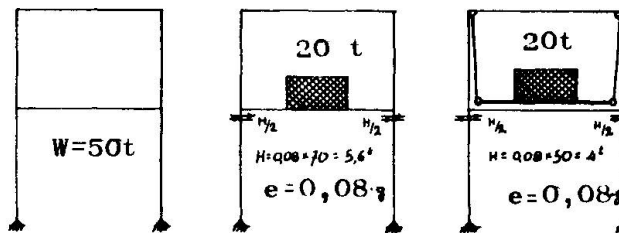

Fig. 4

$H = 0,08 \times (50 + 20) = 5,6$ t. Let us hang the heavy mass from the ceiling of the room; now this weight moves freely as a pendulum and offers absolutely no opposition to any seismic motion of the supporting structure. Therefore: seismic motion will not affect the motion of the heavy mass m in any significant way. This means that as far as seismic effects upon the supporting structure are involved, this heavy mass practically does not exist! The total seismic thrust acting upon the columns of the ground floor is not $H = 5,6$ t; but it is only $H = 50 \times 0,08 = 4$ t.

Similarly let us consider the high building shown in Fig. 5. The weight of the supporting structure is $W = 1000$ t; the weight of live loads on it is $W = 1000$ t; when these live loads rest directly upon the supporting slabs, the total seismic thrust upon the columns of the ground floor is $H = 0,06 \times (1000 + 1000) = 120$ t. But let us construct a new auxiliary floor for every room and hang it from the ceiling of the room. The new floor moves freely like a pendulum and does not oppose any seismic motion of the supporting structure. All live loads rest upon the new suspended floors. They are practically untouchable by seismic effects. Therefore, the total seismic thrust upon all the columns of the ground floor is now:

$$H = 0,06 \times 1000 = 60 \text{ t.}$$

Of course, we do not have to construct hanging floors! This was a suggestion made just for arguments' sake. It is much more convenient and economical to use the antiseismic filter or elastomer-layers and bring the heavy masses to rest upon them. The result is very much the same.

The technique of using the antiseismic filter or elastomer-layers as described above, is of course very simple; everybody can use it. The antiseismic filter can be used equally well to isolate the whole supporting structure from the supporting ground. This work, however, is a very expensive and delicate operation that requires specialists; it should be confined to be used only for special buildings and monumental works of great historical or archeological value. The operation is similar to the procedure of underpinning a whole construction in order to replace the old foundation by a new foundation.

The new foundation includes the antiseismic filter. The operation is considerably more expensive and delicate than a usual renewal of foundations, because we must also connect one with the other all isolated footings. The new foundation should be constructed exactly as described in my papers presented in Constanta and New York, or else left aside. Arbitrary simplifications and modifications to

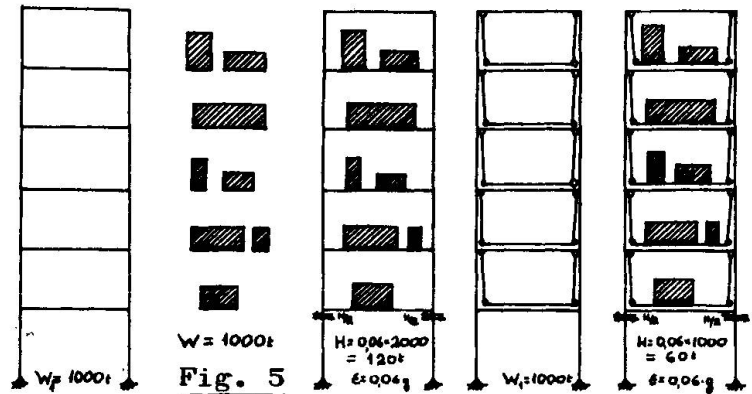

suit the contractors might result in a deterioration of the situation concerning the building under consideration. This is a case of "All or Nothing!". Therefore we should use the antiseismic filter properly or not use it at all. Of course the same is equally true for any substitute for the antiseismic filter: All or Nothing!

So, I feel that I must repeat it: the use of the antiseismic filter (or of elastomer-layers in upper floors) in order to bring heavy masses to rest upon them, is a very simple technique for everybody to use. On the contrary, the introduction of the antiseismic filter between the supporting ground and the whole supporting structure is a delicate job for specialists.

NOTE A : There should be no confusion between 1) a heavy mass resting upon an antiseismic filter or an elastomer-layer, and 2) a suspended bridge; because the suspended bridge: a) does indeed oppose the horizontal motion of the piers upon which it rests or from which it is suspended, and b) it is a complicated elastic system that behaves quite peculiarly when it is set into motion. Therefore we will not say that a suspended bridge is untouchable by seismic effects just because it is "suspended". Of course, we can always introduce the antiseismic filter between the piers and the desk of the suspended bridge, or between the piers and the supporting ground, in order to modify or attenuate seismic effects upon the bridge; but this is a different question.

NOTE B : A water tank completely filled up and closed, behaves like a rigid body which is rigidly connected with the supporting structure. Seismic motion affects the whole mass of the water contained in it, and the corresponding seismic thrust is produced to act upon the supporting structure. But in a partially filled water tank the mass of water does not oppose the motion of the supporting structure, because this mass of water is free to move. Therefore, depending on the condition that the walls of the water tank are strong enough to resist any minor shock from the water contained in it, a partially filled water tank is practically untouchable by seismic effects. Therefore, in seismic zones we must leave empty an adequate free space within every closed water tank for the water to move in easily. In other words: in seismic zones, all closed water-tanks must be partially filled. The same conclusion is equally true for all closed fluid tanks, whether they contain oil, petrol or wine. I have been told that for chemical reasons the containers of certain fluids must be completely filled up; in

any similar case, a light and weak cover will be built to separate the mass of the fluid from the free space within the container.

When we have done everything that is possible in order to lighten the weight of the structure by removing heavy masses or by isolating them from the supporting slabs, then we start thinking about the proper way of facing the seismic effects that are expected to act upon this structure.

The most simple way of calculating the seismic forces that are expected to act upon the structure is the following: we admit that 1) the motion of the ground is given by the equation:

$\ddot{x}=c$ for $0 < t < t_1$; $\ddot{x}=-c$ for $t_1 < t < t_2$; $\ddot{x}=c$ for $t_2 < t < t_3$; $\ddot{x}=-c$ for $t_3 < t < t_4$; $\ddot{x}=c$ for $t_4 < t < t_5$; and so on, for the very small intervals

$0 \rightarrow t_1$; $t_1 \rightarrow t_2$; $t_2 \rightarrow t_3$; $t_3 \rightarrow t_4$; $t_4 \rightarrow t_5$; etc. and 2) for each floor of a multistory building, the whole structure below this floor makes an undeformable body that follows exactly the motion of the ground while the whole structure above this floor makes an undeformable body that must follow exactly the motion of the ground. Therefore, the complete set of all structural members that connect the upper part of the building with the lower part of it, must exert upon the upper part of the building a seismic thrust equal to the product : (the weight of all masses rigidly connected with the upper part of the building) \times (the acceleration of the ground). This is clearly shown in the analytical series of drawings in Fig. 6. In the case (a) the seismic thrust acting upon the columns of the ground floor is: $H_1 = m_1 \cdot c$, because ABB_1A_1 is assumed to be undeformable and the columns of the ground floor are assumed to be practically undeformable. This last assumption is equivalent to assuming that the moment of inertia of the cross-section of the columns is very large. In the case (b) the seismic thrust acting upon the columns of the first floor is: $H_2 = m_2 \cdot c$, because ABB_2A_2 , which was assumed to follow exactly the motion of the ground, i.e. to move with the acceleration c , is assumed to be undeformable, and must follow exactly the motion of the ground, i.e. it must stop now! because the ground stops at this moment , and the columns in the first floor are assumed to be practically undeformable.

In the case (c) the seismic thrust acting upon the columns of the second floor is: $H_3 = m_3 \cdot c$, because ABB_3A_3 , which was assumed to follow exactly the motion of the ground, i.e. to be motionless at $t=t_1$, is assumed to be undeformable and must follow exactly the motion of the ground, i.e. it must move now with the acceleration $(-c)$ because the ground moves now with the acceleration $(-c)$ and the columns in the second floor are assumed to be practically undeformable.

In the case (d) the seismic thrust acting upon the columns of the third floor is: $H_4 = m_4 \cdot c$ because ABB_4A_4 , which was assumed to follow exactly the motion of the ground, i.e. to move with the acceleration $(-c)$, is assumed to be undeformable and must follow exactly the motion of the ground, i.e. it must stop now! because the ground stops at this moment and the columns in the third floor are assumed to be practically undeformable.

In the case (e) the seismic thrust acting upon the columns of the fourth floor is: $H_5 = m_5 \cdot c$, because ABB_5A_5 , which was assumed to follow exactly the motion of the ground, i.e. to be motionless at $t=t_2$ is assumed to be undeformable and must follow exactly the motion of the ground, i.e. it must move now with the acceleration (c) , because the ground moves now with the acceleration (c) , and the columns in the fourth floor are assumed to be practically undeformable.

We continue in the same way until all the upper floors are taken into consideration.

CONCLUSION: In order to calculate the seismic thrust we multiply the weight of any mass rigidly connected with the supporting structure by the acceleration (c) assumed for the ground, and consider this seismic force to act at the centroid of the object under consideration.

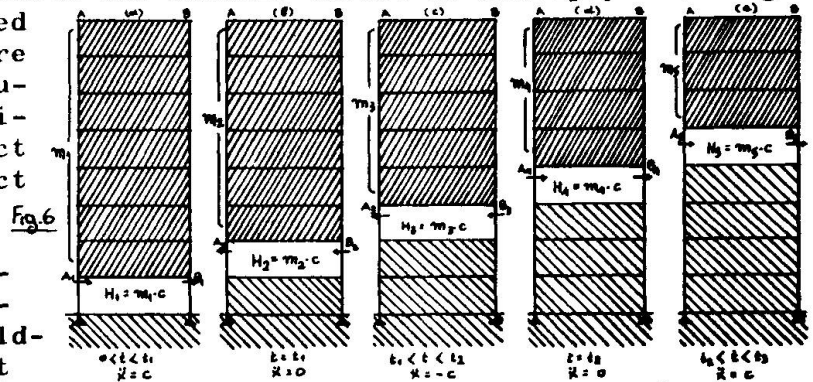

Therefore, it is very important to remember that the identification of seismic effects upon a multistory building with seismic forces that are equal to the product : (acceleration c assumed for the ground) x (weight of each mass rigidly connected with the supporting structure), acting upon this building, is not equivalent to the replacement of seismic effects by equivalent wind-forces in a static way. As a matter of fact, any similar identification is quite irrational and meaningless, unless it comes out as the result of a dynamic consideration of the motion of the building when the motion of the ground is given by the equations: $\ddot{x}=c$ for $0 < t < t_1$; $\ddot{x}=-c$ for $t_1 < t < t_2$, etc., but not by the equation $\ddot{x}=c$ alone. That means that this identification is always implicitly connected with a very rapid change in the value and the direction of the seismic motion. Therefore, it is always implicitly connected with a very rapid growing and vanishing of seismic forces.

Therefore:

We keep clearly in mind the assumption that the seismic forces acting upon the structure vary with extreme rapidity both in value and in direction; for this assumption we determine the seismic forces in the following way: Every mass rigidly connected with the supporting structure is acted upon by a horizontal force which is equal to the product of this mass by the value of the acceleration of the ground.

As soon as we have determined these forces, we try to build the supporting structure that will be able to resist them.

THE TECHNIQUE OF BUILDING THE SUPPORTING STRUCTURE THAT WILL RESIST THE SEISMIC FORCES THAT ARE EXPECTED TO ACT UPON AN OLD BUILDING

As a rule, all multistory buildings contain a supporting structure made out of reinforced-concrete, prestressed-concrete, steel or wood and including vertical columns and horizontal slabs. Therefore, as a rule, the existing supporting structure has the form shown in fig. 7.

This structure risks to have some columns broken, because they were not initially built to resist important bending moments. But now important bending moments due to the seismic forces are produced at the extremities of each column.

I have presented adequate methods in order to increase the resistance of old columns to additional bending moments. / 1/, / 2/ These methods can be used here if only a small number of columns in the whole building need strengthening. But if the large majority of the columns of the whole building need strengthening, then it is much easier and more economical to modify the supporting structure as shown in the Fig. 8. That is: in each and every floor we build the structure shown in Fig. 9.

Sometimes it is not possible to build the X-form connections, because these will obstruct a door or a window. In that case we build the connections as shown in the fig. 10, the values of q, q', r and r' depending upon the position of the door or the window.

The old supporting structure enriched with the oblique connections makes a space-truss. We use traditional methods of statics in order to determine

the value of the pulling force induced in every oblique connection, the axial force induced in every column and the axial forces induced in every slab.

As a rule, this computation will reveal that the slabs and the columns are strong enough to resist additional stresses due to seismic effects. If by any chance a column is found out to be weak, we can always strengthen it by using the technique introduced by my paper that I presented in Budapest. /11/ Therefore, the whole technique that we must present now consists in the proper construction of the oblique connections.

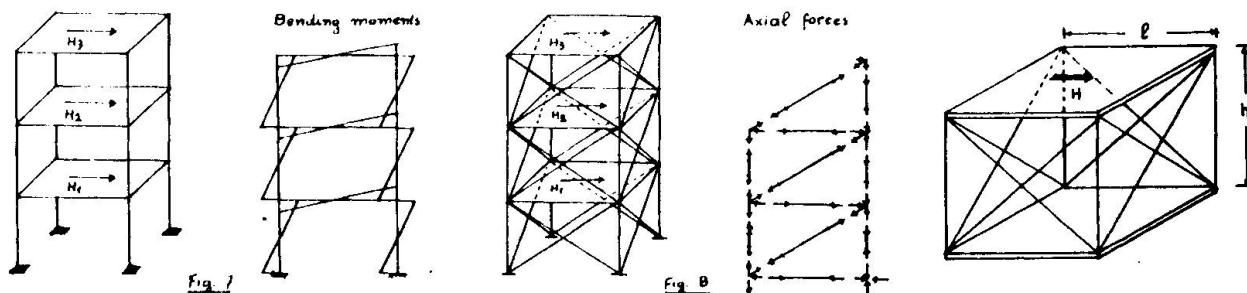

NUMERICAL EXAMPLES:

1) For the structure shown in fig.19 we have the values $H = 25t$, $h = 3,00$ m $l = 10,00$ m. The pulling force in each oblique connection is:

$$N = \frac{\sqrt{h^2 + l^2}}{2} \cdot \frac{H}{l} = \frac{\sqrt{5^2 + 10^2}}{10} \cdot \frac{25}{2} = 14t$$

The axial force in each column due to seismic effects is:

$$AP = \pm \frac{h}{l} \cdot \frac{H}{2} = \pm \frac{5}{10} \cdot \frac{25}{2} = \pm 6,25t$$

and the axial forces in the slab is of course $H = 25 t$.

2) For the same structure shown in Fig.20 we have the values $q = q' = 45^\circ$ and $r = r' = 60^\circ$. Under the action of the force $H/2$ the system of the oblique connections is deformed. There are two kinds of deformation: a) each triangle AGD and BKC is deformed; i.e. the angles r, r', q and q' change; and b) each triangle AGD and BKC rotates respectively about the joints D and C. For the deformation of each triangle we write the equations:

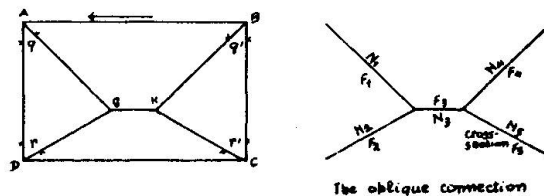
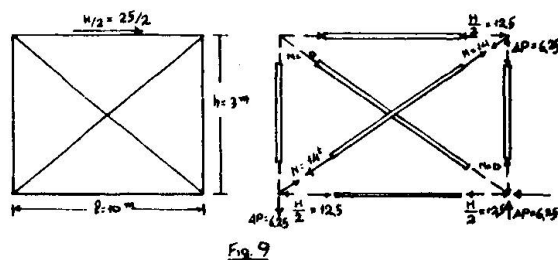

Fig. 10

for the triangle AGB: $\frac{AG \cdot (1 + N_1/E F_1)}{\sin(r + \Delta r)} = \frac{GD \cdot (1 + N_2/E F_2)}{\sin(q + \Delta q)} = \frac{AD \cdot (1 + AP_1/E F_c)}{\sin(\pi - q - r - \Delta r - \Delta q)}$

For a realistic computation we put: $\pi - q - r - \Delta q - \Delta r = \pi - q - r$, $\frac{\Delta P_1}{E F_c} \rightarrow 0$ & $\frac{N_1}{E F_1} = \frac{N_2}{E F_2} = \frac{2400}{2100000}$ assuming that we use high quality steel plates. Then we have the relation $1,00114 \cdot AG / \sin r = 1,00114 \cdot GD / \sin q = h / \sin(q+r)$

These equations are written: $\sin(r + \Delta r) = 1,00114 \cdot AG \cdot \sin(q+r) / h$; $\sin(q + \Delta q) = 1,00114 \cdot GD \cdot \sin(q+r) / h$ whence we obtain the values of Δq and Δr . In our numerical example it is: $AG \cdot \sin 45^\circ = GD \cdot \sin 60^\circ$ and $AG \cdot \cos 45^\circ + GD \cdot \cos 60^\circ = 3,00$ m whence: $AG = 2,70$ m and $GD = 2,21$. Then it is: $\sin(60 + \Delta r) = \frac{1,00114 \cdot 2,70}{3,00} \cdot \sin(60 + 45) = 0,8703$ whence $60 + \Delta r = 60^\circ 30'$ therefore $\Delta r = 30'$. Similarly we obtain $\Delta q = 27'$.

for the triangle BKC: We write similarly $\frac{BK \cdot (1 + N_3/E F_3)}{\sin(r' + \Delta r')} = \frac{KC \cdot (1 + N_4/E F_4)}{\sin(q' + \Delta q')} = \frac{BC \cdot (1 + \Delta P_2/E F_c)}{\sin(\pi - q' - r' - \Delta q' - \Delta r')}$

which is simplified into $1,00114 \cdot 2,70 / \sin(60 + \Delta r') = 1,00114 \cdot 2,21 / \sin(45 + \Delta q') = 3,00 / \sin 75^\circ$ whence we obtain $\Delta r' = 30'$ and $\Delta q' = 27'$.

Therefore the deformation of either triangle AGD and BKC is not really important.

Next we consider the rotation of each one of these two triangles with respect to the foot joint; of course the rotation φ is equal for both triangles. Fig. 2I

First we write the equations for the static equilibrium of all the joints; so, we have:

for the joint A: $N_1 \cdot \sin(q+\varphi) \cong \frac{H}{2}$ for the joint D: $N_2 \cdot \cos r = \Delta P_{DA}$
 $N_1 \cdot \cos q = \Delta P_{AD}$ $N_2 \cdot \sin(r-\varphi) = H_D$

for the joint G (let w denote the rotation of GK with respect to G):

$N_3 = [N_1 \cdot \cos(\frac{\pi}{2} - q - \varphi - \omega) + N_2 \cdot \cos(\frac{\pi}{2} - r + \varphi + \omega)]$ with $N_2 \cdot \cos(r - \varphi - \omega) = N_1 \cdot \cos(q + \varphi + \omega)$

for the joint K: $N_3 \cdot \cos(\frac{\pi}{2} - r' - \omega - \varphi) + N_4 \cdot \cos(r'+q') = N_5$; $N_3 \cdot \cos(\frac{\pi}{2} - q' + \omega + \varphi) + N_5 \cdot \cos(r'+q') = N_4$

for the joint B: $N_4 \cdot \cos q' = \Delta P_{BC}$ for the joint C: $N_5 \cdot \cos r' = \Delta P_{CB}$
 $N_5 \cdot \cos(\frac{\pi}{2} - r' - \varphi) = H_C$

After that we consider the static equilibrium of the whole truss ABCD in the horizontal direction: $\frac{H}{2} + H_D - H_C = 0$

in the vertical direction: $(\Delta P_{DA} + \Delta P_{CB} - \Delta P_{AD} - \Delta P_{BC}) \cdot \cos \varphi = 0$

with respect to the joint D: $\frac{H}{2} \cdot h + (\Delta P_{DA} - \Delta P_{AD}) \cdot l = 0$

In this way we have established 13 relations between the 13 unknown quantities $N_1, N_2, N_3, N_4, N_5, \Delta P_{AD}, \Delta P_{DA}, \Delta P_{BC}, \Delta P_{CB}, H_D, H_C, \varphi$ and w .

From these relations we obtain easily the system of the following 7 equations with the unknown quantities $N_1, N_2, N_3, N_4, N_5, \varphi$ and w :

$$N_1 = \frac{H}{2} \frac{1}{\sin(q+\varphi)}, \quad N_2 = \frac{H}{2 \cos r} \left(\frac{\cos q}{\sin(q+\varphi)} - \frac{h}{l} \right)$$

$$N_3 = \frac{H}{2 \sin(q+\varphi)} [\sin(q+\varphi+\omega) + \cos(q+\varphi+\omega) \cdot \text{tg}(r-\varphi-\omega)]$$

$$N_4 = \frac{N_3}{1 - \cos^2(q'+r')} [\sin(r'+q'+\omega) \cdot \cos(q'+r') + \sin(q'-\varphi-\omega)]$$

$$N_5 = \frac{N_3}{1 - \cos^2(q'+r')} [\sin(q'-\varphi-\omega) \cdot \cos(q'+r') + \sin(r'+q'+\omega)]$$

$$N_5 \cdot \sin(r'+q') - N_4 \cdot \sin(r-\varphi) = \frac{H}{2}$$

$$N_2 \cdot \cos r + N_5 \cdot \cos r' - N_1 \cdot \cos q - N_4 \cdot \cos q' = 0$$

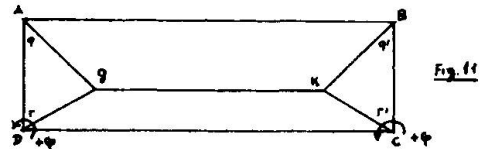

For the values of the numerical example my assistants have obtained the following results: $\varphi \cong 15^\circ, w \cong 0^\circ$

$N_1 \cong 13t; N_2 \cong 5,0t; N_3 \cong 16t; N_4 \cong 7t; N_5 \cong 15t; \Delta P_{AD} \cong 6,5t; \Delta P_{BC} \cong 7,5t$

Attention should be paid to the fact that this form of the oblique connections is very deformable! The displacement of the head of the column with respect to the foot of it, is equal to $\Delta l = h \cdot \text{tg} = 300 \times 0,2679 = 80 \text{ cm}$.

Depending on the architectural form of the ground-floor, this large deformation is a big advantage or a big disadvantage. If the architectural finishing can endure this deformation, then this large deformation may be a big advantage, because it makes an efficient protection for the building against seismic shocks; but if the architectural finishing cannot endure this deformation, then we must choose the X-form for the oblique connections and place them along an inner partition-wall, where they will obstruct no door. The formulae given above hold equally well for the X-form connections, if only we put $w = \frac{\pi}{2} - q = \frac{\pi}{2} - r'$.

I think that we should always remember that the X-form oblique connections are simple and safe for everybody to use; on the contrary, the >< -form oblique connection is a very delicate construction, that only a specialist should build.

The next step is to construct the oblique connections.

Now we must recall the following psychological fact, which, unfortunately is well established beyond any doubt, and universal: People are too prompt to forget the risk and the terror produced by earthquakes; then, when they start remembering it again, it is too late for any strengthening of old buildings! Therefore, if we really wish an old building to be strengthened against seismic forces, then we must make available a very simple and quick technique. Otherwise, strengthening of the building is postponed and finally forgotten.

The technique presented in this paper is so simple, that one can hardly think of anything simpler; and it is quite efficient.

We work in the following way:

- 1.- We make a hole at the head and at the foot of every particular column that makes a vertical member of the supporting space-truss. We try to make the distance (d) as short as the drilling instruments we can dispose of allow it. Fig. 22
- 2.- We bend pieces of strong rods of mild steel as shown in the figure. The length L_1 is a little shorter than the width (a) of the column. The extremity (A) is threaded to be ready for a nut. The length L_2 depends on the force that will act upon this rod; it must be sufficient for the welding of this rod onto the steel plate that makes the oblique connection.
- 3.- We place this piece of mild steel through the hole in the column.
- 4.- We use steel plates to construct the oblique connections. The cross-section of each steel plate depends on the pulling force that will act upon it, and on architectural requirements.
- 5.- We place the steel plates into position as shown in Fig. 22b, and
- 6.- We weld the rods onto them.
- 7.- After that we screw the proper nut onto the threaded end of the rod, stretching it as much as we can, and then we weld the nut onto the rod. That is all!

Of course it is strongly advisable to use a gusset and to place the oblique connections symmetrically with respect to the vertical axis of the column (i.e. to use a double oblique connection placed at both sides of the column) whenever this is possible.

NOTE: It is not necessary to fix the oblique connections upon the external columns of the building. Most often, it is much more convenient to fix them upon internal columns along a partition-wall which is not ever expected to be removed. In that case, as a rule, it is convenient to use a double oblique connection placed at both sides of the partition wall. This double oblique connection works much more efficiently than the simple oblique connection just described. In that case, instead of a threaded end waiting for a nut, we bend this end and weld it onto the steel plate of the second oblique connection.

When the supporting structure is made out of steel columns, the construction of the oblique connections is even easier, because then, all that we have to do is just to weld the ends of these connections onto the steel columns. But in this case it is strongly recommended to use double oblique connections and to place them at both sides of the steel columns. / 3/ For a wooden house we work as we do with reinforced-concrete columns.

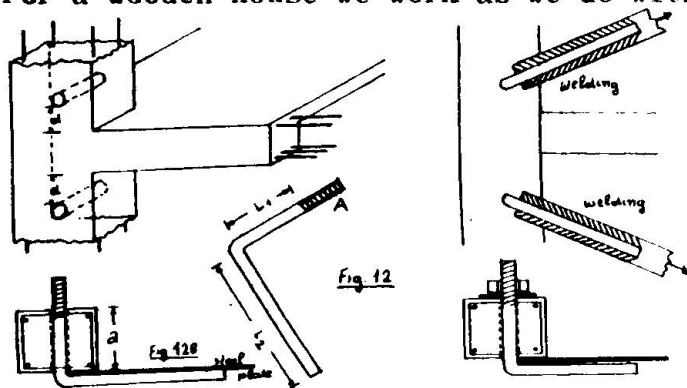

The vertical acceleration of the ground?

All the things that we have said in the preceding pages refer to seismic effects produced by the horizontal motion of the ground. We must remember that earthquake produces sometimes vertical motion of the ground. I think that the best way to face seismic effects due to the vertical acceleration of the ground is to use

the sliding articulations described in my paper that I presented in Liège. / 4/ This technique is good for a new structure; we cannot use it in old buildings. But statistics comfort us with the realistic conclusion that it is quite rare for old buildings in seismic zones to be destroyed by vertical acceleration of the ground.

THE FOUNDATION

It is important to consider always the action of seismic effects due to the horizontal motion of the ground, upon the foundation of the old building. If the old building stands upon a network of foundation-beams or a general foundation slab, then we have no problem with the foundation; if the columns upon which we fix the oblique connections stand upon isolated footings, then we must strengthen the foundation, because the isolated footings will not be able to resist the horizontal thrust produced by the oblique connections.

There are two techniques to use for strengthening the old foundation. 1) We remove the old floor that rests upon the soil and build a new reinforced concrete slab that makes the new floor; this slab must enclose tightly all the columns of the building and be strong enough to resist the axial stresses produced by the oblique connections.

Sometimes it is easier and more economical to build the new reinforced concrete slab upon the old floor.

I must say that this way of strengthening the foundation is efficient but primitive.

2) A more subtle technique is the following:

- .- we make a hole through each column just above the old floor;
- .- we place a piece of rod of mild steel through it;
- .- we place steel plates upon the floor between all the columns and weld the rods onto them;
- .- we place steel plates in the perpendicular direction upon the floor between all the columns;
- .- we take proper auxiliary pieces of steel plates and weld them upon a second set of steel plates.

That is all!

If the steel plates must not protrude above the old floor even for one centimeter, then we make a one-centimeter deep trench and put the steel plates in these mini-trenches.

In this way we build a network of orthogonal steel plates that interconnect all the columns of the building. The seismic thrust induced in the oblique connections is resisted by these steel plates, which are stressed to tension.

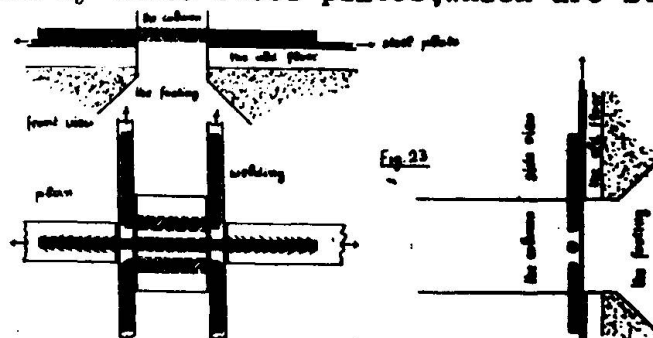

REFERENCES

1. MARINAKIS, K.: A mode to strengthen deficient reinforced-concrete slabs, beams, columns and footings; Proceedings, 6^o Congress, C I B Budapest 1974
2. " " : Une méthode pratique pour augmenter la résistance des poteaux et des semelles isolées; Proceedings, Colloque Inter-Associations AIPC-FIP-CEB-RILEM-IASS, Liège 1975
3. " " : Une façon de renforcer les constructions en acier et mixtes contre les forces sismiques; Documentation; Colloque, IABS, Dresden 1975
4. " " : Une façon d'éliminer les fissures dues au tassement différentiel du sol dans une construction en béton armé précontraint; Compte-rendus; Colloque Inter-associati AIPC-FIP-CEB-RILEM-IASS, Liège 1975

CONSTRUCTION OF SMALL BUILDINGS IN
HIGH SEISMIC AREAS OF INDIA

Satyendra P. Gupta
Reader in Structural Dynamics
School of Research and Training in
Earthquake Engineering
University of Roorkee
Roorkee, (U.P.), India

SUMMARY

Unengineered construction has experienced considerable damage in earthquakes in India. These are traditional construction in which the maximum population of the country lives. This paper deals with the construction practice for small buildings in seismic areas of the country and urgency for improving the earthquake resistance of these construction.

1. INTRODUCTION

More than fifty five percent of the area in the country lies within the seismic zone and areas of Assam, some portions of North Bihar, Kashmir and Gujrat area are highly seismic. Some of the most destructive earthquakes have occurred in these areas. Unengineered construction like mud houses, stone rubble masonry and brick homes have experienced maximum damages in these devastating earthquakes. These are traditional construction in which maximum population of the country lives. Earthquake is not only the factor which effects the construction of the dwellings in these areas but other factors like climatic conditions, availability of building materials with natural resources and the economic condition of the people plays an important role. These type of construction suffer damage as they have very little or no tensile strength, poor bonding between walls and bad workmanship. Still these dwellings are being built in the most conventional way due to the knowledge of local construction in the rural areas. In the Urban areas brick homes of one or two storeys, rubble stone construction and a typical Assam type construction in which bamboos are used are built. It is very difficult to rule out the construction of these types of homes in seismic areas of India but some suitable means must be found out to strengthen these homes, so that their strength is adequately increased to withstand the earthquake shock. A study of the construction practices of small dwellings in seismic areas have been presented and their performance in earthquakes and strengthening measures have been discussed.

2. SEISMIC AREAS OF INDIA

The seismic zoning map of the country is shown in Fig. 1. In the preparation of this map greater recognition has been given to features of the various parts of the country. But as considerable data on earthquake occurrences and their associated tectonic features is not available and large maps showing orogenic structural stratigraphic belts have not been prepared for many parts of the country, only tentative modifications have been adopted in the different seismic zones. The whole country has been divided in to five zones like zone I, II, III, IV and V with zone V indicating the area of high seismicity. The modified Mercally Intensity associated with the various zones are V or less, VI, VII, VIII and IX and above for zones I, II, III, IV and V respectively. These limits of intensity have been recommended for the purpose of design but these limits are not necessarily be always the highest intensity that could occur any where within the given zone. As an earthquake is unpredicatable, it is possible in some cases that much higher intensity may be felt at any particular spot. The probabilities are that a structure designed on the assumption that intensity indicated for each zone is about the maximum that is likely to occur, would atleast in sure a reason able amount of safety from collapse. The code provision is for the structures which are designed and for engineered construction but most of the construction discussed here in are low cost and unengineered and no regard has been given to the use of code in most cases.

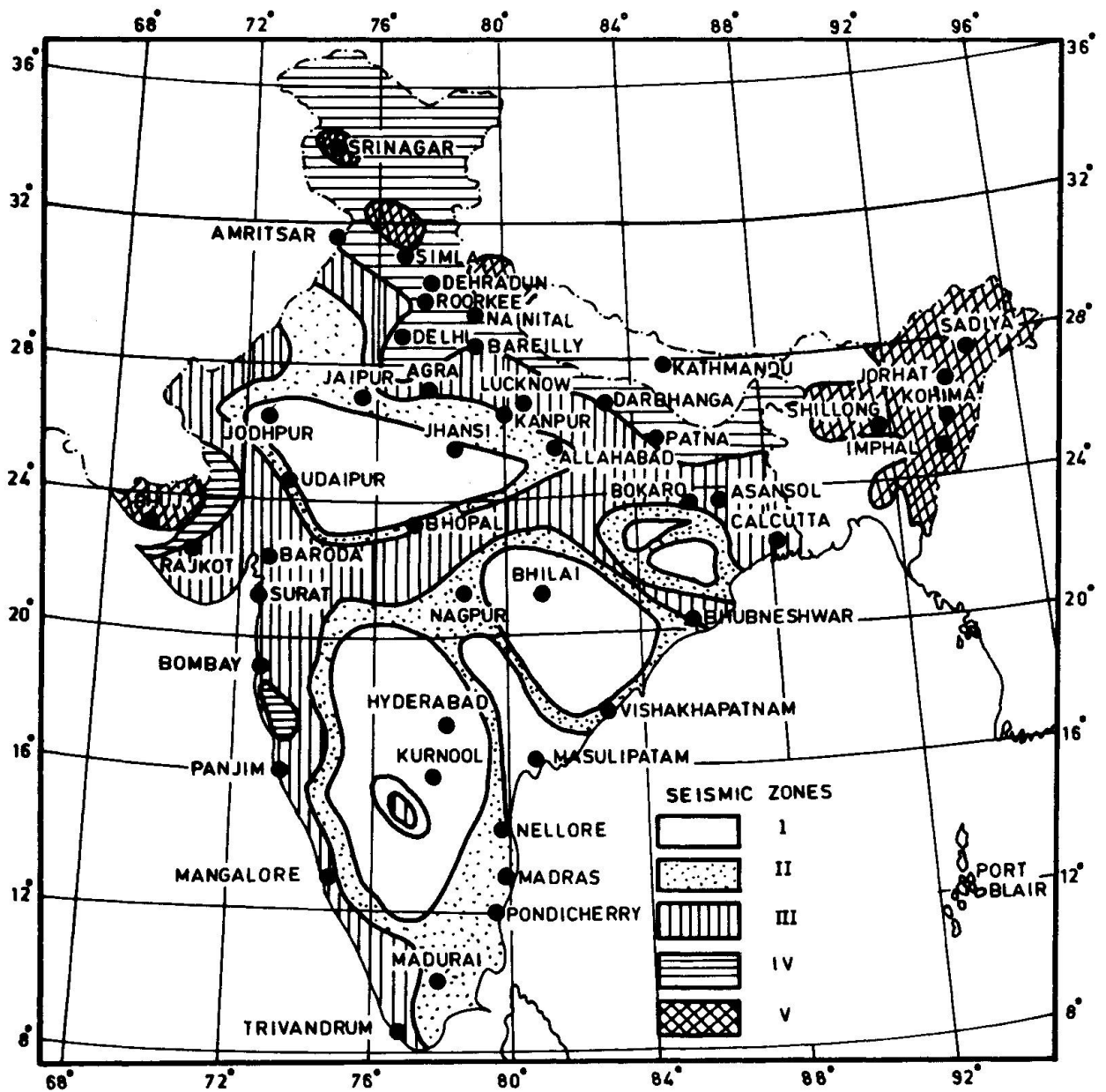

FIG.1-SEISMIC ZONING MAP OF INDIA

3. CONSTRUCTION PRACTICES OF SMALL DWELLINGS

3.1 The Village hut or Mud House

Traditional construction for dwellings takes the form of a village hut, as Indian villagers have been living in this from centuries and this form of construction is still prevalent today. These huts are usually made of mud walls with suitable coverings as roof. These are unengineered construction in which no proper foundation is made and the plinth itself is raised from ground level to about 30-35 cm in mud in the form of a raft or block. All walls are made of mud with suitable openings left for doors and windows. These mud walls are thick at the base level and as the height of the wall progresses its thickness is reduced and in most cases the wall is of same thickness all long. The clay mud for making these homes is generally mixed with local species of straw usually either the paddy or wheat husk and pounded well with clay to make a paste. The paste is allowed to be soaked in water for few days before the actual construction starts. After the plinth is raised rough blocks of clay are made by hand, and when still moisture laid one over the other arbitrarily with no set pattern. The whole height of the wall is achieved in a few days with intermediate drying of the wall in sun. The walls made of clay have rough surfaces on both faces and in order to make them smooth, they are smeared with same mud plaster and sometime cowdung is also used for this purpose. Mudhomes always have pitched roof with timber and bamboos serving as ridge and purlins and thatched covering is provided for the roofing. Some areas will have claytiles put on as roofing. The walls of these homes are badly eroded by weathering action and rain and its life is short. In some areas of the country the walls as well as roofing both are made of thatch and they are highly prone to fire too. In order to reduce the fire hazard of thatched homes, the walls are smeared with mud plaster on both sides. These village huts have practically no lateral resistance and get badly damaged during moderate or low intensity earthquakes.

3.2 Semi-Permanent Houses

Another type of construction which is quite prevalent in villages are semi-permanent type. In this different categories of houses could be found depending upon the economic well being of villagers and these homes are definitely better than mud homes. These are constructed of unburnt bricks or adobe in mud mortar on poor foundation. Another type is of poor quality burnt bricks which has extremely low compressive and tensile strength set in mud mortar and some what good quality bricks set in mudmortar or in very rare cases cement mortar. The walls of these homes are generally $1\frac{1}{2}$ to 2 bricks thick, and have very low heat transfer capacity. In most cases these homes too have either thatched roof or clay tiled coverings. For building these homes in villages where the majority of the country resides, have no guide lines and all these are built in an unengineered manner without due regard to lateral stiffness and strength as these are constructed along the accepted traditional practice. In the north-eastern part of the country majority of private dwellings are of this type.

3.3 Assam Type Huts

Assam in the eastern part of the country is known as the home of earthquakes lies in a highly seismic zone and is the most unstable region in the country. It has suffered several catastrophic earthquakes during last century such as earthquakes of 1897, 1930, 1943, 1947 and 1950. Experiences of earthquakes have taught the people to build a lighter home. The construction of homes in this area is generally light weight with use of local building materials. Tatch (obtained from ulOO-grass), bamboo, ekra (a reed), timber grows profusely throughout Assam and has been used widely at a good advantage by the people. The most common type of homes for low income group in Assam is popularly known as "Assam type" building. It generally consists of sloping roofs with a ridge longitudinally at the centre and covered with thatch, tile or C.G.I. Sheets. The walls are made of bamboo or timber framing with ekra matting and mud plastering. The broad classification is as follows:

3.4 Kutchha Temporary Homes

This construction is prevalent in villages. The building materials used are thatched roofing, bamboos for posts walls and roofing frame, ekra matting for walls, cane tying and mud for plastering the walls. The bamboo posts are driven about 60 cm in the ground, plinth is raised to 30 to 60 cm of mud raft. The height of the house above the plinth level is generally 2.25 m to 2.75 m. The walls are provided with either ekra or bamboo mats and plastered with mud on both sides generally 1 cm thick. The doors are single leaf made of bamboo-chatai with bamboo frame. It will have a sloping roof provided with bamboo frame covered with 15 cm thick thatch.. Where the timber is easily available the bamboo is replaced by timber and roofing will have trusses and height of the dwelling will increase by 30 to 45 cm than bamboo homes.

3.5 Wooden frame and ekra Construction

This type of construction costs more than bamboo homes. Walls of these homes have the frame work of timber battens with panels generally 1 to 1.5 square meter in area. The battens are of Sal, Hollock or Koroi with sizes 7.5 x 7.5 cm or 7.5 x 10 cm. An ekra or split bamboo matting is provided centrally in the timber frame work. The wall is then plastered on both sides by either mud, lime or cement. The thick-ness of walls being barely 5 cm. For supporting the superstructure wooden piles of 25 to 75 cm diameter driven a few meters into the ground are used. These houses are also supported on short piers of stone, or brick masonry, such that the superstructure is free to move as a whole and it is this characteristics which helps it in good behaviour during earthquakes.

Where stone Masonry is available, it is frequently used with conventional foundation and galvanised iron sheet sloping roof covering. This construction if done well has shown good behaviour and little damage and poor workmanship in these homes have resulted in total collapses.

Another construction which have not behaved well in the Brahmaputra valley is a combination of brick masonry and ekra in which the

lower 1 to 1.25 m of the walls are of brick masonry and upper portion of plastered ekra or bamboo mat within timber panels. Roofing is invariably G.I. sheeting. The foundations are of conventional type footing or superstructure resting on short piers.

4. DAMAGES SUFFERED BY SMALL HOUSES IN PAST EARTHQUAKES AND IMPROVEMENTS

Due to very poor lateral resistance all most all mud homes have been destroyed in past earthquakes. It has been found that traditional form of construction of walls is the main cause of damage. It has been suggested that walls of mud homes should be thicker at the base and thin at the top, with inner and outer surfaces having parabolic cross-section. In order to increase the strength of mud walls against weathering effect and also against earthquakes introduction of bamboo jaffri in the centre of the wall is desirable. Semi permanent homes have also suffered widespread damage with severe cracks all along the walls. In spite of the fact that these homes were damaged, such houses are still being constructed in traditional way in the seismic areas. As the damages of huts due to heavy roofs have been wide spread it is desired that roofs should be light since during large vibrations the inertia of heavy roofs break the walls on which they rest. The necessity of tying ends should be avoided and hip roof construction should be preferred.

5. INDIAN STANDARD CODE PROVISION FOR EARTHQUAKE RESISTANT DESIGN AND CONSTRUCTION

The Indian Standard Code for earthquake resistant design caters the need of engineered construction and is completely silent about the dwellings constructed in small towns and village where the construction follows the traditional way, quite unaware of the modern engineering developments and earthquake risks. Even small brick buildings are not designed to be earthquake resistant. The Indian Standard Code of practice for earthquake resistant construction recommends some measures to improve the earthquake behaviour of structures. Here again it is presumed that these provisions are used in engineered buildings and of masonry, timber or concrete construction. Some of the salient features of the code is that a structure should be as light as possible consistent with structural safety and functional requirements. The roof should be adequately tied with the walls so that in the event of an earthquake they may not become loose and fall off. For pitched roofs C.G.I sheets or asbestos sheets should be used in place of tiles. For masonry homes use of mortar, plinth, lintel and roof band is recommended. Reinforcement should also be provided in the form of vertical bars at doors and windows openings. Timber construction should be generally restricted to two storeys.

6. TASKS AHEAD

Seeing the provisions in the earthquake code it is felt that they will cater the needs of engineered construction only. In a developing country where 40% of the population is below poverty line and more than 70% of the people live in villages in temporary homes or poorly built homes unaware of the modern developments it is necessary that simple and relatively in expensive methods for

strengthening traditional construction be developed which could be easily adopted by village artisans without any extra effort. The local and municipal bodies in the high seismic area of the country must formulate rules and regulations for aseismic construction of small homes so that total collapses of the dwellings could be avoided, and life and property could be saved.

7. CONCLUSION

During severe earthquakes the traditional construction has suffered maximum damage in India. Still today construction is done according to traditional practices quite unaware of the needs for earthquake. Most of the codes fulfill the requirements for engineered and good quality construction but there is an urgent need for making unengineered construction such as mud houses, unburnt brick homes, thatched construction, stone rubble etc. safe. Hence code specifications are needed for these type of construction. There is also a need to develop simple and inexpensive methods of strengthening traditional building to make it earthquake resistant and the methods developed must be simpler enough to be adopted by village artisans without any extra effort. In practice the code specifications are generally empirical and there is a need for making it scientific.

8. REFERENCES

1. India, Indian Standard Code of Practice for Earthquake Resistant Construction of Buildings, IS:4326-1976, Indian Standard Institution, New Delhi, 1976.
2. India, Indian Standard Criteria for Earthquake Resistant Design of Structures, IS:1893-1975 (Second Revision), Indian Standard Institution, New Delhi, 1975.
3. Gupta, Satyendra P. and R.P. Metha, "Construction of Small Buildings in Seismic Areas of India", Term paper for P.G.Diploma, SRTEE, University of Roorkee, Roorkee, 1977.

Leere Seite
Blank page
Page vide

SOME ASPECTS OF THE METHODOLOGY OF RESTORATION AND RENEWAL
OF BUILDINGS DAMAGED IN THE 1976 FRIULI EARTHQUAKES

Dr. Marcello Conti - President, Conti & Associati S. p. A., - Udine (Italy)

Dr. Livio Fantoni - Structural Department, Conti & Associati S. p. A. - Udine
(Italy) EERI member

SUMMARY

Some aspects of the methodology of restoration of buildings damaged in the 1976 Friuli earthquakes are looked into in the paper.

Those include some considerations relating to the ultimate conditions of masonry buildings strengthened against seismic action vis-a-vis a seismic coefficient $K = 0.20$.

Further illustration is provided of a technical form with the purpose of determining the cost parameters of renewal of buildings damaged by the earthquake.

1. FOREWORD

The 1976 Friuli Earthquake is marked by particular aspects owing to the simultaneous presence of a number of characteristic factors, which are:

- a) The extension of the area affected (5,275 sq. Km. according the official statistics of the Friuli-Venezia Giulia Region, corresponding to 137 Municipal areas).
- b) The number of inhabitants involved (approx. 590,000).
- c) The fact that only 19 of the 137 Municipal areas were previously classified as seismic zones (2nd category).
- d) The age and the typological building characteristics of the structures, in particular as regards the area destroyed or seriously damaged (84 out of 137 Municipalities and an area of 3,431 sq. Km. out of 5,275).

An attempt will subsequently be made to specifically analyse some of the methodological characteristics for the restoration of the damaged buildings, with special reference to common housing in the area affected by the earthquake which, though it presents rather varied typological and construction characteristics, nevertheless offers a certain basic uniformity. This makes it possible to face certain problems (such as, for instance, a rapid estimation of restoration costs), with the certainty of obtaining satisfactory results.

2. TYPOLOGICAL CHARACTERISTICS

The number of housing units surveyed in the months immediately following the earthquake of 6 May which were considered suitable for restoration come to approx. 60,000 (in the case of about 9,000 the evaluation was found to be negative).

The average volume of the units is about 670 cu. met., with a minimum volume of 500 cu. met. in the case of buildings intended for housing accommodation alone; 890 cu. met. for buildings with auxiliary or annexed space intended for productive activity; and 1,080 cu. met. in the case of rural building with agricultural extensions (with a minimum of 300 cu. met. of accommodation in mountain areas and a maximum of 1,500 cu. met. of accommodation in the plains).

As regards buildings put up before 1900, the distribution aspects of the housing accommodation vary from area to area (in mountain zones one tends to find agricultural activity carried out on the ground floor, while the living area is usually upstairs; in the plains living space is also extended to the ground floor, with a general tendency to set up an annexe in line with the main unit, where agricultural activity is carried out).

The building materials are rather uniform, at least where their original composition is concerned (stone and wood), while the structural typology assumes particular aspects depending on the age of the structure and its geographical location.

In the case of buildings put up at a later date, the normal distributive and functional characteristics of present day housing units - usually of the single-family type - hold true.

Given their high incidence in the context of the problem being dealt with, particular attention will be given to housing accommodation structures as described above.

3. STRUCTURAL TYPOLOGY

As has been underlined, there does not exist a structural type that can be described by a single definition, in as much that the structures damaged by the 1976 earthquakes are to be found in areas with conspicuous historical, cultural and economic differences.

However, a certain uniformity does exist, except in cases of structures of a more recent date and also of the more important edifices as regards the construction materials and their use.

Taking these common factors into account, buildings may be grouped together in satisfactorily uniform categories:

a) Isolated buildings

Having a regular plan, built of irregular stone and poor quality mortar, with a wooden flooring, varied wooden roofing.

In time may have undergone structural alterations, such as outer extensions and the replacement of parts of the flooring with reinforced concrete monolithic slabs or reinforced concrete and brick slabs.

b) Continuously-arrayed buildings

Put up in the interior of habitated centres, include various living quarters and present a continuous façade along the street.

Their plan may therefore turn out to be rather intricate. Structurally they are made up of a ground floor, first floor, storehouse and wooden roofing. The bearing walls consist of two façades parallel to the street (supporting the roofing and generally the flooring of the storehouse) and of dividing walls, distanced at approx. 5 m at right angles to the street, which bear the first floor.

The materials are always wood and stone.

In this case too, modification of the original structure may be carried out by the putting up of a floor, the replacement of some of the floorings and the construction of additional structures perpendicular to the disposition of the array.

c) Recent buildings

Built in brick-work, flooring in reinforced concrete-brick slabs, in some

cases the load-bearing structure in reinforced concrete. Generally based on irregular plan, often badly built and without particular reference to modern technological know-how.

- d) As already noted, it should also be kept in mind that, notwithstanding the fact that the region is subject to high earthquake probability, only a small part was included in the 2nd category of seismic zones as per standing Italian Regulations. In this zone, which includes Tolmezzo, Verzegnis and a number of other Municipal districts which were subjected to a serious earthquake in 1928, structures built after this date according to the standing anti-seismic regulation of the period are to be found.

4. STRUCTURAL BEHAVIOUR

Taking into consideration the buildings of types a) and b), the bearing structure is made of non-squared stone masonry walls with low values of the aspect ratio, high specific gravity and rather low shear resistance.

The wooden floor is supported by wooden beams, resting on the walls.

The roofing is made up of roof - tree, trusses and common rafters resting directly on the wall or by means of wooden sleepers.

There are no ties, and practically never any joints between longitudinal and transversal walls.

The structural weight of the building is almost entirely made up of the weight of the walls and the overloading is practically negligible. In these conditions, lacking any bearing or connection whatsoever between the vertical elements, each element functions independently of the others, thus not being subject to torsional effects even in case of highly complex plans. In fact, the stiffness of the wall element may be shown as:

$$k_i = \frac{G_i \cdot A_i}{1.2 h_i}$$

while its weight should be:

$$W_i = \gamma_i A_i h_i$$

Should all the elements be of the same material and of the same height, the weight of the flooring being negligible, the centre of rigidity coincides with the centre of the mass.

The situation changes when some structural elements are replaced with others of different material and with a greater values of the shear modulus and when the light flooring are replaced with reinforced concrete-brick slabs whose weight is no longer negligible and whose stiffness on their own plane is considerable.

Thus, the forces begin to be concentrated on the more rigid elements, while lightening the others; at the same time torsional effects arise.

As concerns the shear behaviour of the walls, spread cracks appear throughout their height, revealing in this way, in particular as regards the façade, the weakening caused by door and window openings.

It should be noted, moreover, that often the bearing walls are found to have been subjected to demolition and partial reconstruction, raising, openings for doors and windows, with a consequent modification of their static behaviour.

Further, given the almost complete absence of ties or tendons correctly placed, all the walls show gaps relative to those lying at right angles to them.

It may therefore be stated on the whole that all the buildings in the area affected by the 1976 earthquake, some of them dating back several centuries, were not built according to anti-seismic criteria.

The use of costlier materials and technology could not be afforded, except in the case of a few important structures, given the economic condition of the area.

The local artisan construction tradition appears to be lacking in skill even when compared to contemporary building standards.

The modification to the original masonry structures, carried out with materials and techniques borrowed from other types of constructions (it should be kept in mind that a part of local labour is employed in the building trade), not having been inserted appropriately in the structural concept of building, has in most cases worsened the existing situation.

5. METHODOLOGY OF RENEWAL

As has been mentioned previously, it is clear that structural renewal should aim at providing the structure with an acceptable degree of safety, while staying within certain economic and environmental criteria.

Concentrating on the safety criteria alone, the first step is to choose a masonry box as the resisting element.

The renewal to be carried on the frame consists in connecting the masonry walls in both directions.

Such connection may be made in various ways: by means of ties with double tendons so as to avoid eccentric compression in perimetral beams; by repairing the corners using steel mesh and concrete covering.

If the box made up of walls in stone and poor quality mortar, the shear factor has to be improved by injecting cement mix into the entire wall mass in order to achieve a satisfactory structural uniformity.

The reinforcement of the box may be effected in other ways, as for instance by strengthening the masonry with steel mesh or by introducing new dividing walls in solid brick or concrete.

For purposes of endowing the masonry with a certain solidity, wooden flooring is often replaced with a reinforced concrete hollow brick slab. From the structural view point this intervention represents a radical modification

compared to the original scheme.

The box thus acquires its covering. It is obvious that the reinforced concrete-brick flooring operates as an efficient horizontal diaphragm which links together all the masonry it engages.

Torsional effects, which are lacking in the absence of the diaphragm, may therefore appear. Moreover, the presence of the new flooring, of a weight that is no longer negligible, may influence the behaviour of the foundation.

Correct planning should always aim at the coincidence of the centre of the mass with the centre of rigidity. Owing to this, if the masonry frame is in any way deficient, it is better to avoid the introduction of excessively stiff resistant elements which might unload, in an undesirable manner, the masonry having a shear modulus of low magnitude.

The consideration should be uniform over the entire range of elements so as to enable them to carry out their task of resisting horizontal forces but without concentrating on them dangerous stresses as regards the shear and the overturning moments.

Only if a correct co-operation of all the reinforced masonry is achieved, is it then possible to limit the safety verification of the building to shear resistance assessment.

Such testing should then be extended to all the floors and not only to the base of the building, in case variations are met with from floor to floor as regards resistance and the arrangement of the walls.

6. CALCULATION AND EVALUATION METHODS

The Italian norms laid out in the Ministerial Decree of 3/3/1975, which refer to the repair of masonry structures, do not contain adequate directions vis-a-vis planning aimed at the strengthening and safety of buildings in the context of seismic action.

To this end the Autonomous Region of Friuli-Venezia Giulia has issued, as an extension of the above-mentioned norms, recommendations that are the outcome of co-operation with various experts and organizations - both national and foreign.

Of particular importance among these recommendations is the test required for buildings that have been strengthened, with the purpose of assuming the behaviour of these structures in the presence of seismic action.

In brief, it is to be ascertained that the ratio VK between the horizontal forces bearing on the building in its ultimate conditions and the weight of the building is greater than a value $VK = G_1 \cdot C_2 \cdot 1.1 \cdot 0.2$ where C_1 and C_2 are values determined by the geomorphological nature of the ground, 1.1 is the safety coefficient and 0.2 is the seismic coefficient.

The verification may be carried out in one of many ways, but with the existence of the conditions cited above, it may simply be a verification on the average value of shear forces in the masonry.

In more complex cases, or as an aid to the project intended to optimize the arrangement of the strengthening elements, an iterative step by step method may be employed, which would locate the distribution of the shear forces on the various resisting elements, up to their yield point.

Given the particular constructional typology of the buildings, these two methods provide satisfactorily reliable results and, if correctly employed, can constitute an important step forward relative to the current Italian norms.

7. PARAMETRICAL EVALUATION OF RESTORATION COSTS

Besides the gradual development and the widening of the renewal methodology in the structural sector, it was also necessary to face the problem of a rapid evaluation of the costs of restoration. This was intended to facilitate the application of the first regional laws that touched the economic sphere, in order to accelerate to the utmost the renewal operations.

In this sense the authors, in their roles as consultants to the Regional Administration within the framework of the Central Interdisciplinary Group, have worked together to formulate a draft of the costs of renewal (tables 1 to 4).

The solution adopted made it possible, within a three-month period (that is, in the period enclosed by the first earthquake of 6 May 1976 and the second, that of 15 September), to survey and examine nearly 65,000 housing units, this being carried out with a maximum of 300 groups, each composed of 3 technicians.

Over and above an indication of the characteristics elements of the buildings, sub-divided into single housing units, the form puts forward in 4 tables parametric evaluation scheme of the repair costs, laid out thus:

- a) The different constructional elements of the building (column 1) and the possible typologies of the elements themselves (column 2) are listed.
- b) Column 3 shows the ratio in the ambit of each structural element, of the existence of different typologies (for example, if a building is made up of two bodies, of which one represents 60% of the volume with its bearing elements in stone and the other in hollow bricks, column 3 shows 0.6 which corresponds to the first type and 0.4 to the second).
- c) The evaluation of the renewal cost is calculated on the basis of a volume index, according to the average parametric values (columns 5 and 8) relative to the various structural types. These costs (table 5) were determined (for example in case of buildings with bearing elements in stone, with wooden flooring) on the basis of the incidence of costs, for a typical structure, of a completely new construction and of total renewal and with reference to the overall volume of the building.
The cost of partial renewal was deduced from these (normally equal to 50% of total renewal) and column 5 and 8 were compiled beforehand.

The prices of course refer to May 1976.

In order to obtain the partial renewal cost, the value of column 3 is multiplied by the percentage of renewal considered necessary and also by the relevant unit cost, thus obtaining different partial costs, which then give the total renewal cost (with reference to the preceding example, if 50% of the stone masonry requires total renewal, 30% partial renewal, and no renewal for the rest. The relevant renewal cost is obtained as follows:

$$0.60 \cdot 0.50 \cdot 13,000 + 0.60 \cdot 0.30 \cdot 6,500 = \text{L/Cu. Met. } 5,070$$

relative to the overall volume of the building).

- d) Column 10 sums together all the renewal costs relative to the single structural types and gives the final value.

Though presenting certain difficulties owing to different evaluation assessment, the system adopted drew complaints from only 5% - 6%, and it was possible to evaluate a total renewal cost of about 250 billion Lit. (approx \$ 300 M.).

The total cost of the project was about Lit. 2.7 billion, corresponding to Lit. 33,000 per building, referring to the total number of structures surveyed (about 80,000) up to April, 1977.

From the point of view of efficiency and validity of the method, the following consideration may be drawn:

- For a particular type of building (for instance for buildings in stone bearing walls and wooden flooring) for which partial renewal is foreseen with an anti-seismic protection (whose cost was estimated around 4,000 - 5,000 Lit/Cu. Met.) a total cost index of about 23,000 Lit/Cu. Met. is obtained which with an increase of about 30% gives the present cost of about 30,000 Lit/Cu. met.
- On the basis of the first renewal plans (at present there are a further 30,000 buildings yet to be repaired) at current prices, it may be that the average renewal cost varies between 30,000 and 40,000 Lit/Cu. Met. . It is however necessary to take into consideration the fact that recent regional laws have permitted not only simple renewal of damaged buildings but also complete renewal with anti-seismic protection and the recovery of housing accommodation by means of works related to technical and distributive functionality, and this type of work normally involves an expense of 2,000 - 4,000 Lit/Cu. Met.

8. CONCLUSION

The widespread dimensions of the seismic action of 1976 in the Friuli region have raised various problems that may be considered to have been partly resolved, and which in part is the subject of further study and research.

From the operational point of view, the research for the restoration and renewal that assure anti-seismic protection of buildings - mainly for those with bearing masonry, and the adoption of evaluation methods of the related costs in a short period of time - these have aided in leading to a concrete start-up of the reconstruction stage, with its first phase consisting of repair of the damaged structures.

Leere Seite
Blank page
Page vide

VERBALE DI ACCERTAMENTO
dei danni ad edifici per uso abitazione o misto

N. squadra N. d'ordine

--	--

Foglio 1

Data _____

NOTIZIE RELATIVE ALL'EDIFICIO																					
Provincia _____	Comune _____	<table border="1" style="font-size: 8px;"> <tr> <td style="width: 15px; height: 15px;"></td> <td style="width: 15px; height: 15px;"></td> <td style="width: 15px; height: 15px;"></td> <td style="width: 15px; height: 15px;"></td> <td style="width: 15px; height: 15px;"></td> <td style="width: 15px; height: 15px;"></td> </tr> <tr> <td colspan="6" style="text-align: center; font-size: 8px;">(riservato all'ufficio)</td> </tr> </table>							(riservato all'ufficio)												
(riservato all'ufficio)																					
Frazione _____	Via _____	n. _____																			
Partita catastale <table border="1" style="font-size: 8px; display: inline-table;"><tr><td style="width: 15px; height: 15px;"></td><td style="width: 15px; height: 15px;"></td><td style="width: 15px; height: 15px;"></td><td style="width: 15px; height: 15px;"></td><td style="width: 15px; height: 15px;"></td></tr></table>						Foglio <table border="1" style="font-size: 8px; display: inline-table;"><tr><td style="width: 15px; height: 15px;"></td><td style="width: 15px; height: 15px;"></td></tr></table> n. mappale			<table border="1" style="font-size: 8px; display: inline-table; margin-right: 10px;"><tr><td style="width: 15px; height: 15px;"></td><td style="width: 15px; height: 15px;"></td><td style="width: 15px; height: 15px;"></td><td style="width: 15px; height: 15px;"></td></tr></table> <table border="1" style="font-size: 8px; display: inline-table; margin-right: 10px;"><tr><td style="width: 15px; height: 15px;"></td><td style="width: 15px; height: 15px;"></td><td style="width: 15px; height: 15px;"></td><td style="width: 15px; height: 15px;"></td></tr></table> <table border="1" style="font-size: 8px; display: inline-table;"><tr><td style="width: 15px; height: 15px;"></td><td style="width: 15px; height: 15px;"></td><td style="width: 15px; height: 15px;"></td><td style="width: 15px; height: 15px;"></td></tr></table>												
Non accatastato <input type="checkbox"/>	Riferimento <table border="1" style="font-size: 8px; display: inline-table;"><tr><td style="width: 15px; height: 15px;"></td><td style="width: 15px; height: 15px;"></td></tr></table>			<table border="1" style="font-size: 8px; display: inline-table; margin-right: 10px;"><tr><td style="width: 15px; height: 15px;"></td><td style="width: 15px; height: 15px;"></td><td style="width: 15px; height: 15px;"></td><td style="width: 15px; height: 15px;"></td></tr></table> <table border="1" style="font-size: 8px; display: inline-table; margin-right: 10px;"><tr><td style="width: 15px; height: 15px;"></td><td style="width: 15px; height: 15px;"></td><td style="width: 15px; height: 15px;"></td><td style="width: 15px; height: 15px;"></td></tr></table> <table border="1" style="font-size: 8px; display: inline-table;"><tr><td style="width: 15px; height: 15px;"></td><td style="width: 15px; height: 15px;"></td><td style="width: 15px; height: 15px;"></td><td style="width: 15px; height: 15px;"></td></tr></table>																	
<p>1. Edificio composto da n. <table border="1" style="font-size: 8px; display: inline-table;"><tr><td style="width: 15px; height: 15px;"></td><td style="width: 15px; height: 15px;"></td></tr></table> piani fuori terra</p> <p>2. Fronti comuni con altri edifici n. <table border="1" style="font-size: 8px; display: inline-table;"><tr><td style="width: 15px; height: 15px;"></td><td style="width: 15px; height: 15px;"></td></tr></table></p> <p>3. Scantinato: totale <input type="checkbox"/> parziale <input type="checkbox"/> no <input type="checkbox"/>; sottotetto praticabile: no <input type="checkbox"/> si <input type="checkbox"/></p> <p>4. Alloggi n. <table border="1" style="font-size: 8px; display: inline-table;"><tr><td style="width: 15px; height: 15px;"></td><td style="width: 15px; height: 15px;"></td></tr></table></p> <p>5. Abitazione rurale con annessi rustici: no <input type="checkbox"/> si <input type="checkbox"/>, n. <table border="1" style="font-size: 8px; display: inline-table;"><tr><td style="width: 15px; height: 15px;"></td><td style="width: 15px; height: 15px;"></td></tr></table></p> <p>6. Attività produttive ubicate nell'edificio: no <input type="checkbox"/> si <input type="checkbox"/>, n. <table border="1" style="font-size: 8px; display: inline-table;"><tr><td style="width: 15px; height: 15px;"></td><td style="width: 15px; height: 15px;"></td></tr></table></p> <p>7. Et� presumibile dell'edificio: ante 1850 <input type="checkbox"/> 1850-1900 <input type="checkbox"/> 1920-1950 <input type="checkbox"/> dopo 1950 <input type="checkbox"/></p>																					
GIUDIZIO SINTETICO SULL'EDIFICIO																					
<p>8. Distrutto <input type="checkbox"/></p> <p>9. Non ripristinabile <input type="checkbox"/></p> <p>10. Ripristinabile: totalmente <input type="checkbox"/> parzialmente <input type="checkbox"/> Necessitano riparazioni strutturali? si <input type="checkbox"/> no <input type="checkbox"/></p> <p>11. Riparazioni gi� eseguite: in tutto <input type="checkbox"/> in parte <input type="checkbox"/></p> <p>12. Non necessitano interventi <input type="checkbox"/></p>																					
CONTRIBUTO																					
<p>13. Costo stimato delle opere di riparazione: lire _____</p> <p>14. Spese per riparazioni gi� eseguite: lire _____</p> <p>15. Totale lire _____ x 80% = lire _____</p> <p>16. Alloggi n. <table border="1" style="font-size: 8px; display: inline-table;"><tr><td style="width: 15px; height: 15px;"></td><td style="width: 15px; height: 15px;"></td></tr></table> x lire 6.000.000 = lire _____</p> <p>17. Abitaz. rurali con annessi rustici n. <table border="1" style="font-size: 8px; display: inline-table;"><tr><td style="width: 15px; height: 15px;"></td><td style="width: 15px; height: 15px;"></td></tr></table> x lire 10.000.000 = lire _____</p> <p>18. Attivit� produttive n. <table border="1" style="font-size: 8px; display: inline-table;"><tr><td style="width: 15px; height: 15px;"></td><td style="width: 15px; height: 15px;"></td></tr></table> x lire 4.000.000 = lire _____</p> <p>19. Totale lire _____</p>																					
NOTE																					
<p>Eventuali indicazioni su particolari motivi che consigliano la conservazione dell'edificio: _____</p> <p>_____</p> <p>_____</p> <p>Altre osservazioni: _____</p> <p>_____</p>																					
<p>Firme dei componenti il gruppo di rilevamento</p> <p>_____</p> <p>_____</p> <p>_____</p>	<p>Firma del proprietario, dell'usufruttuario o dell'amministratore</p> <p>_____</p> <p>_____</p> <p>_____</p>	<p>Firma di convalida del sindaco</p> <p>_____</p> <p>_____</p> <p>Data _____</p>																			

NOTIZIE SULL'UNITÀ IMMOBILIARE N. [][]

Foglio 2 _____ Data _____

N. squadra N. d'ordine

--	--

NOTIZIE RELATIVE ALLE UNITÀ IMMOBILIARI COSTITUENTI L'EDIFICIO

Edificio di partita catastale n. [][][][][][] foglio [][] n. mappale [][][][][] sub. [][]

ALLOGGIO O ABITAZIONE RURALE

1. Alloggio effettivamente e stabilmente occupato al 5.5.76:

Totale stanze n. [][] occupanti n. [][] rilevati dal gruppo

risultanti al Comune: occupanti n. [][]

2. Titolo di godimento dell'alloggio: proprietà affitto

3. Alloggio non occupato effettivamente e stabilmente al 5.5.76:

Totale stanze n. [][]

4. Motivo della non occupazione:

alloggio abbandonato alloggio sfritto altro _____

alloggio occupato solo per parte dell'anno perchè:

seconda abitazione

occupanti emigrati altro _____

ANNESI RUSTICI

5. Stalla m³ _____ 6. Fienile m³ _____ 7. Deposito attrezzi m³ _____

LOCALI PER ATTIVITÀ PRODUTTIVE

8. Laboratorio artigiano m³ _____ 9. Negozio m³ _____

10. Ufficio o studio professionale m³ _____ 11. Altro m³ _____

PROPRIETARIO/I O AMMINISTRATORE DELL'UNITÀ IMMOBILIARE

nome cognome data di nascita indirizzo (comune, via, n. civico)

1. _____

2. _____

3. _____

Firme dei componenti il gruppo di rilevamento

Firma del proprietario/i, dell'usufruttuario o dell'amministratore

Firma di convalida del sindaco

Data _____

Edificio di abitazione in muratura portante in pietra

- n° 2 piani fuori terra

- Orizzontamenti in legno

- Volume 700 mc. vuoto per pieno

Elemento costruttivo	Costo unitario di costruzione	Costo di costruzione in £/mc. di fabbricato	Incidenze sul costo di costruzione del fabbricato	Costo di rifacimento integrale in £/mc. di fabbr.
Strutture verticali				
Murature portanti in pietra	£/mc 38.000	10.260	30,78%	13.000
Orizzontamenti				
Solai in legno	£/mq 10.000	2.285	6,85%	2.850
Struttura copertura in legno	£/mq 10.000	2.145	6,43%	3.600
Manto di copertura	£/mq 4.500	965	2,89%	1.150
Scale	A corpo 240.000	345	1,03%	700
Tramezzi	£/mq 3.500	150	0,45%	200
Intonaci interni	£/mq 3.400	2.770	8,32%	3.000
Intonaci esterni	£/mq 3.500	1.250	3,75%	1.400
Pavimenti	£/mq 7.000	1.490	4,48%	1.700
Infissi	£/mq 60.000	2.800	8,40%	3.000
Fondazioni	£/mc 40.000	860	2,58%	-
Vespaio e caldane	£/mq 4.500	515	1,54%	-
Finiture varie	-	1.000	3,00%	-
Impianto idro-sanit.	A corpo -	1.500	4,50%	1.500
Impianto termico	A corpo -	4.000	12,0%	4.000
Impianto elettrico	A corpo -	1.000	3,00%	1.000
TOTALI	£/mc	33.335	100,00%	

Leere Seite
Blank page
Page vide

REPAIR OF EARTHQUAKE DAMAGED BUILDINGS

by

Loring A. Wyllie, Jr.
Structural Engineer
H.J. Degenkolb and Associates
San Francisco, California U.S.A.

SUMMARY

A thorough analysis of an earthquake damaged structure must be made before repairs and strengthening work can be designed and executed. First, the earthquake damage must be thoroughly investigated and the causes for the damage determined. Repairs for the damage can then be designed together with any desired strengthening to prevent a recurrence of the damage in the next earthquake. The consequences of the strengthening scheme must then be investigated in detail to insure that it does not in turn become the cause of further damaging effects. Several examples are cited.

INTRODUCTION

After all damaging earthquakes, there is a great desire by building owners to get their buildings repaired and back into operation as soon as possible. Frequently, building owners or local building or government officials will also desire or require that the building be strengthened to provide increased lateral force resistance for preparation of the next earthquake. This paper attempts to outline a procedure for this strengthening and warn of several potential pitfalls frequently observed.

DETERMINING THE DAMAGE CONDITION

The first step in repairing any earthquake damaged structure is determining exactly how the structure performed. This requires a detailed inspection of the building and a listing of all damaged elements and members. It may be necessary to open concealed areas to permit a thorough investigation and insure that hidden damage does not remain undetermined.

The engineer must then analyze the structure and thoroughly understand why the damage occurred. He must satisfy himself of the force resistant paths in the building and why certain members failed or cracked while other members were essentially undamaged. He must determine if members failed due to shear, compression, tension, flexure, bar anchorage, etc. He must consider the effects of non-structural elements such as walls and parapets. This analysis is essential before any repairs can be designed.

DESIGN OF STRENGTHENING SCHEME

Once the damage is documented and understood, the repair of individual members can be designed to return the original or desired strength to the member. Such repairs usually consist of epoxy injection, partial replacement or occasionally, complete replacement of the damaged member.

The engineer then needs to consider how to minimize such damage in the future. He may decide to strengthen selected members which failed and make them considerably stronger. He may decide to add shear walls to stiffen a frame structure. He may replace damaged non-structural walls with structural bracing walls.

Whatever strengthening techniques are chosen, the effects of the strengthened members on adjacent members and the total structural system must be investigated. If certain frame members are made stronger, will the next earthquake simply cause the adjacent unstrengthened member to fail? If a wall element is introduced, will it cause adjacent failures due to overturning forces or stress transfers? If strengthening is added in only one story of a building, will it cause increased damage in other stories of the building which were undamaged in the recent earthquake? The following section provides several examples.

SELECTED EXAMPLES

The first example involves the Colegio Teresiano on the outskirts of Managua, Nicaragua. The building is a three story concrete frame school building of a long rectangular plan, similar to schools built throughout the world. A small earthquake of magnitude 4.6 in 1968 was centered quite close to the building and caused cracking and structural distress to the columns in the first story. The building was repaired by adding a stiffened concrete wall element in the first story between classroom doors and extending up to the second floor balcony rail height. This new wall element can be seen in Figure 1.

The destructive Managua earthquake of December 23, 1972, caused considerable damage to this building, but only in the second and third floors, where considerable column damage resulted. Figure 1 was taken after this second earthquake. The new wall elements in the first floor prevented damage in that floor, but permitted the earthquake forces and motion to travel upward, causing the observed damage. The repairs had not considered the effect on the remainder of the structure. Had these or stronger walls extended to the roof, much of this damage might have been prevented.

A second example shows a three story classroom building at the Agricultural University in the La Molina area of Lima, Peru. There are four identical buildings of concrete construction. The first story was originally framed without structural walls and only columns for support and bracing. Considerable wall panels and masonry partitions were present in the upper two stories. A magnitude 7.5 earthquake on October 17, 1966, caused significant damage to the first story columns, so concrete shear panels were introduced to stiffen and brace this first story.

A second earthquake of magnitude 7.6 affected these structures on October 3, 1974. Figure 2 shows the end of one of these buildings after that earthquake. There was little damage in the first story due to the previous strengthening, but that increased stiffness caused considerable damage in the upper two floors which had not been strengthened after the 1966 earthquake.

CONCLUSIONS

The damage sustained by a structure in an earthquake must be thoroughly understood and analyzed before repairs can be designed. Repairs which involve adding strength or stiffness to a member or structure must be fully analyzed for the impact on adjacent members or stories in future earthquakes.



Figure 1. Colegio Teresiano in Managua, Nicaragua, after 1972 earthquake. First story stiffening wall, which can be seen projecting outward from second floor beam, prevented first story damage but increased upper story damage.

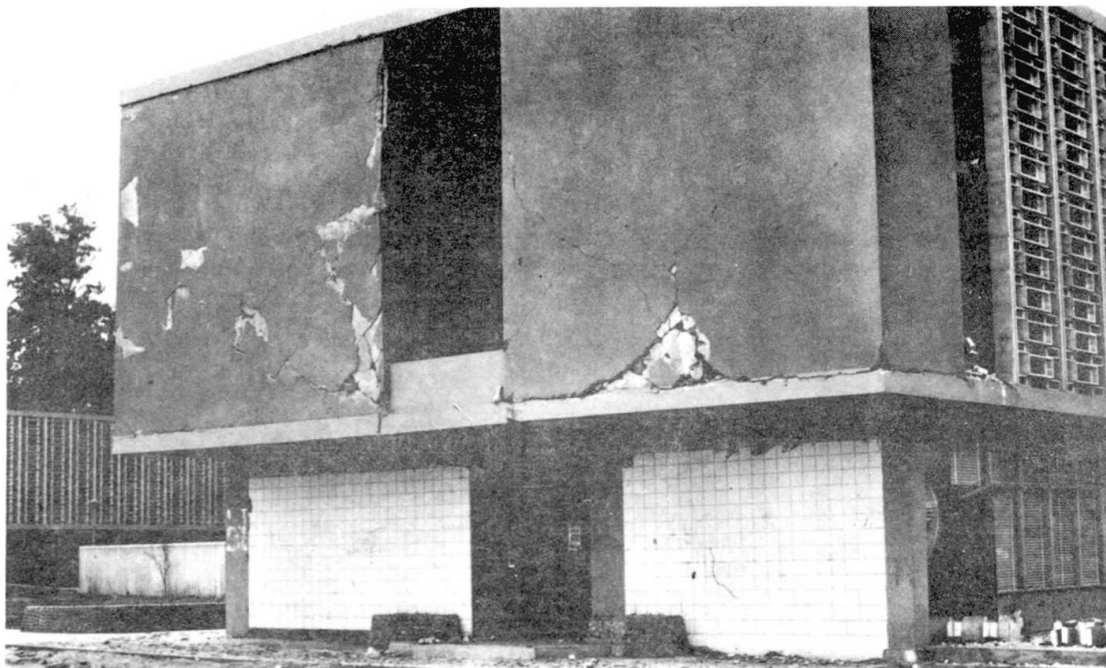

Figure 2. Classroom building at Agricultural University after 1974 earthquake. Stiffened first story had little damage due to added concrete wall panels, but upper stories had increased damage in this earthquake.

Leere Seite
Blank page
Page vide

Abstract models for the structures of a building to be restored

Les modèles abstraits des charpentes dans un projet de restauration

Die abstrakten Modelle der Tragwerke bei den Restaurierungsplan

GUIDO GUERRA

Professor of Architectural Science

University of Naples

Naples, Italy

SUMMARY

In this paper topological models of the structures of buildings are presented: 1) as a technique for representing the mechanical models of bi-dimensional structures (plates, slabs, vaults) by graphs, as is usually done for systems of rods or beams; 2) as a guide to the invention of new constructional schemes for the reinforcement of bidimensional structures; 3) as a criterion for the choice between different mechanical models of the same complex of structures; 4) as a tool for the classification of the different kinds of statical behaviour of a complex of structures before and/or after successive earthquake damage and/or in the various stages of a restoration.

RESUME

Dans cette note on présente des modèles topologiques des structures des bâtiments: 1) comme technique pour représenter les modèles mécaniques des structures bi-dimensionnelles (plaques, dalles, voûtes) avec des graphes; ce que l'on fait généralement pour les systèmes de barres ou poutres; 2) comme guide pour l'invention de nouveaux systèmes de renforcement des structures; 3) comme crite- rium pour le choix entre modèles mécaniques différents du même ensemble de structures; 4) comme outil pour la classification des différentes possibilités de comportement statique d'un ensemble de structures avant ou après des domma- ges sismiques successives et/ou pendant les phases d'une restauration.

ZUSAMMENFASSUNG

In dieser Mitteilung werden die topologischen Modelle der Baustrukturen eingeführt: 1) als Technik, um die mechanischen Modelle von bidimensionalen Strukturen (Platten, Scheiben, Gewölbe) durch Graphs darzustellen, wie es gewöhnlich für Staben-oder Balkensysteme gemacht wird; 2) als Leitung für die Erfindung neuer Systeme für die Verstärkung der bidimensionalen Strukturen; 3) als Wahlmasstab zwischen verschiedenen mechanischen Modelle desselben Struktursystems; 4) als Werkzeug für die Einstufung der verschiedenen Typen von statischen Verhalten von einem Strukturkomplex vor oder nach darauffolgenden seismischen Schäden und/oder während der Restaurierungsphasen.

§ 1.- Retrieval and classification of the informations.

The first operation to be carried out in the study of each building is obviously a formal-geometrical survey: the Author suggests that this should be carried out by a photographic (not stereographic) procedure and successive restitution to the computer (CE 196, 201). The survey must include cracks or splits and must be completed by a series of technological investigations. These data and the successive deductions are co-ordinated by "levels of abstraction" in models: M^1 at the level of the technical drawings (and of the practical geometry); M^2 at the level of the theory of the structures (and of the affine geometry); M^3 at the level of the topology.

The models belonging to each level are connected by the relationships between the three types of geometry. Each technical drawing in fact also contains informations of a projective type (which emerge in the models M^2) and of a topological type (which are the only ones conserved in the models M^3).

It should be noted that several M^2 correspond to a single building: as many as are the conditions of load which have occurred in the history of the building or which could in all likelihood arise.

Each of these models consists of a set of Mechanisms and Resistant Functions. We mean by "Mechanism" a sub-set of constructional elements which absorb one of the systems of loads considered without the other parts of the building being stressed and without being stressed by other forces. "Resistant Function" on the other hand is one of the forms of mechanical behaviour (if more than one should occur) by which a certain complex of constructional elements carries out its static tasks.

Another case to be considered is the collaboration of neighbouring buildings in cases of collapse or demolition (CE 71).

§ 2.- The classification of statical-constructional models is carried out by "levels" of abstraction" and by "scales". These last are generally:

- scale 1 - building complex (large building, city block etc.);
- scale 2 - wing of a building;
- scale 3 - small set of collaborating structures;
- scale 4 - constructional element or connection;
- scale 5 - mural texture; bars and ties in reinforced concrete; etc.

In the higher squares of fig. 1 we see models to scale 3: one half of the set of structures which enclose a room: i.e. a partial frame composed of 4 knots, of the beams and pillars which meet in them and of the collaborating masonry panels and r.c. floors. In the lower squares of the same figure we see the models (to scale 4) of one of the said knots. The two drawings in the squares on the left are M^1 or constructional drawings; those in the centre are M^2 , or static schemes; those on the right, M^3 or topological schemes.

From the example of the figure other modelisations to scale 1, 2, 3, 4, can easily be inferred. Those to scale 5 serve for the study of alterations of the mural texture as can be produced by earthquakes or by fatigue (CE 202).

§ 3.- Static-constructional analysis with models of 2 and 3 abstraction.

In the example of figure 1 the mechanical behaviour is of one kind only, at least in normal conditions: the distribution of the flexural moments in the r.c.

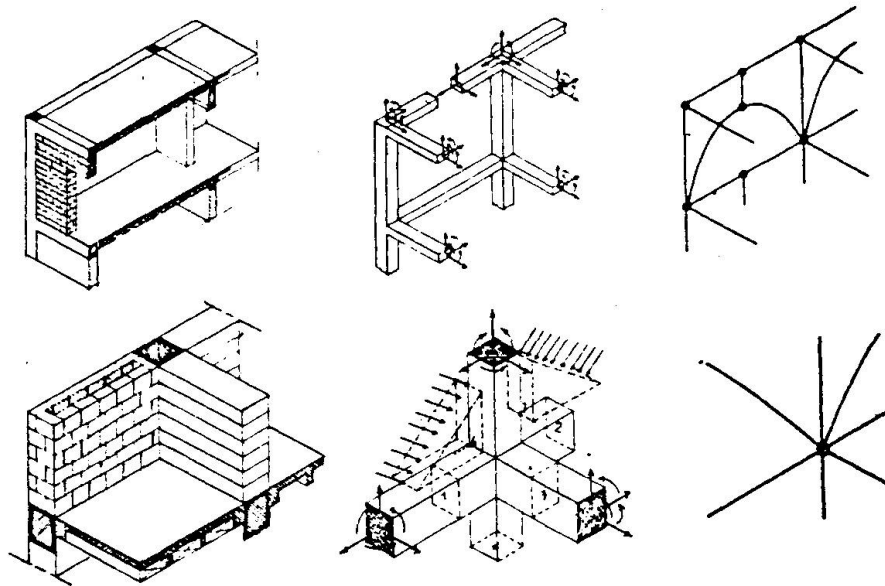

fig. 1

beams and stanchions and the isostatics in the wall panels can vary according to the loads applied but, in each case, the framework behaves as a frame and the walls as slabs.

In the case of earthquake, as is well known, everything can change, also at scale 3. With strong horizontal forces the mural panels can behave as plates especially if they are thick and heavy; and therefore flexional fractures can occur in them. If the disconnections are limited to non-essential structures, cracks or partial collapse occurs: otherwise plastic hinges are introduced in the main frame which generate resistant mechanisms completely different from the original ones; and/or cinematrixal mechanisms which lead to the total collapse. With a careful study of the geometry and of the technology of the building these possibilities can be foreseen. It is therefore advisable to consider, at the 2nd abstraction, besides (or instead of) the elastic models, limit state models both in the global study of the building, scale 1, and of its parts on the successive "scales".

For other and more complex constructions, still at 2nd abstraction, the static interpretation cannot be given satisfactorily by using a single elastic model. Let us consider, for example, a centrally symmetrical (domical or fan or rib vault) fig. 2; it will work generally according to three distinct static functions: (i) membrane, if stresses S , H are balancing the external loads by effect of the curvature; (ii) plate if only the stresses Q_s , Q_h , M_s , M_h , M'_s , M'_h are acting; (iii) slab if the stresses S , H , T balance themselves in the plane tangent to the vault.

For every voussoir quoin (on the basis of the relative size of the above mentioned sets of stresses) and globally (in proportion to the work of deformation produced in the whole dome by each system of stresses) it will be possible to determine how much of the load is entrusted to each resistant function and to represent this tri-partition by a point of a typologies triangular diagram (fig.3).

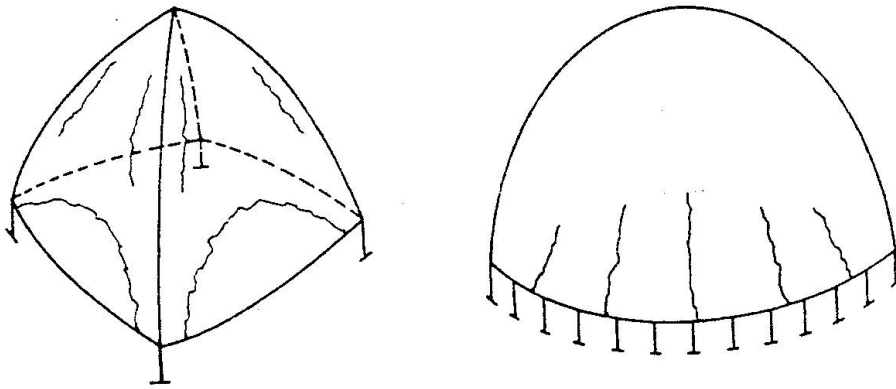

fig. 2

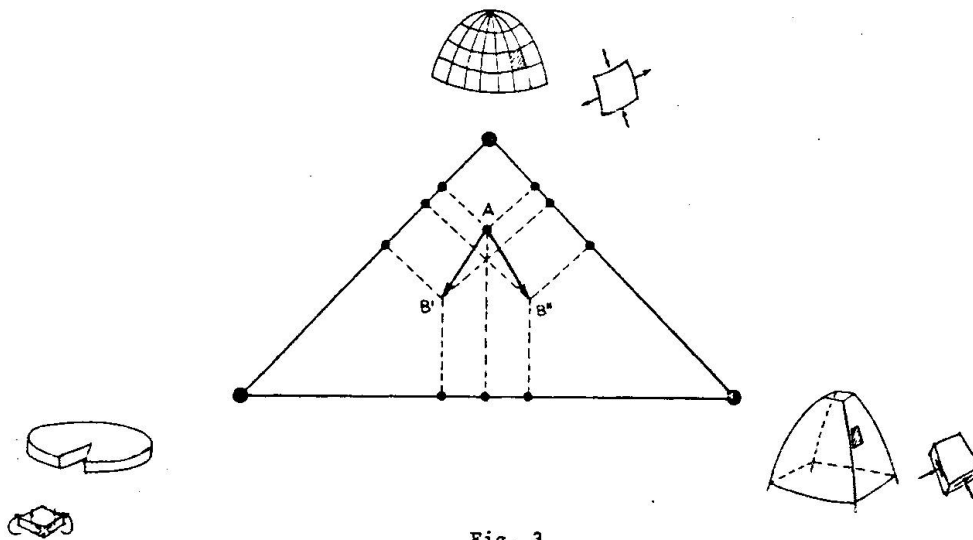

Fig. 3

For any modification of the physical state of the vault (e.g. cracks or partial collapses) there will be a variation of the tri-partition: the representative point will pass in B'' (increase of the plate effect produced by settling of the bearing structures or by arched cracks on the base of the vault); or in B' (increase of the slab effect revealed first by cracks in accordance with the meridians).

The plate effect produces τ stresses which in cloister domes (cupole a padiglione) with continuous support can cause oblique cracks (or also cracks according to the meridians because ring stresses are contrasted by the friction) in the upper part of the haunches, as in S.Maria del Fiore. With discontinuous support we have also arched cracks in the base of the vault.

The slab effect, added to the membrane traction, produces cracks according to the meridians at the base of the dome, as in St. Peter's.

Two interesting examples, one seismic, (a partial collapse in the dome of the Gesù Nuovo, 1638, CE 118) and the other from war damage (partial collapse in the dome of the Gerolomini, 1943) have occurred in Naples; a similar phenomenon, revealed by arched cracks has been observed by ing. Jannaccone in the dome of the church of Monte Calvario in Foggia.

Improvident measures of "destructive" restoration such as the dismantling of the dome of the Gesù Nuovo in Naples in 1760 or, to quote a far more modest but

recent episode, the demolition of the barrel vault (S. Leonardo hospital at Castellammare di Stabia, CE 71) have caused considerable damage to the supporting structures through alteration of the counter-thrusts in the buttresses; experiences which are useful also for interpreting the chain-collapses originating from a first occurrence (partial collapse) and further partial demolitions.

§ 4.- Panelled frames.

In the study of the masonry enfilled r.c. or steel frames the model of 3rd abstraction, i.e. the graph of the connections (drawings on the right of fig. 1) is well known: this model was proposed by Fenves (1963) for programming the computer calculation of steel frames and by the Author (CE 120) for checking the identity of statical behaviour between frameworks the schemes of which are mutually reduceable by operations on the graphs.

It is observed at this point that it is easy to study with the same method the alterations in the scheme of the connections owing to partial collapses and or to erroneous partial demolitions of a r.c. frame and also, as will be seen below, of more complex structures.

After having obtained at topological level (3rd abstraction) a rough idea of the distribution of the stresses in the whole building before and after the partial collapses, we have a trace which must be followed in the study of the model of 2nd abstraction, i.e. in the usual structural analysis.

A first interpretation of the phenomenon at the 3rd abstraction is useful also for flat frames with strutting panels in order to be able to set out correctly at 2nd abstraction (static scheme) the study of mechanical behaviour under horizontal stress.

According to the global slenderness of the ribbed wall (which in multi-floor buildings with standard ratios between the span of the bays and the height of each floor is a topological feature we have, fig. 4, two distinct types of behaviour under horizontal stresses corresponding respectively to the two elementary models for quick calculation: inflected cantilever (left-hand figure), and frame subjected to simple shear (figure on the right).

The picture of the isostatics corresponds respectively to that of a unique plate (representing the whole frame) and to those of the single panels enfilling each bay of the frame: a double possibility confirmed by photoelastic experiments in

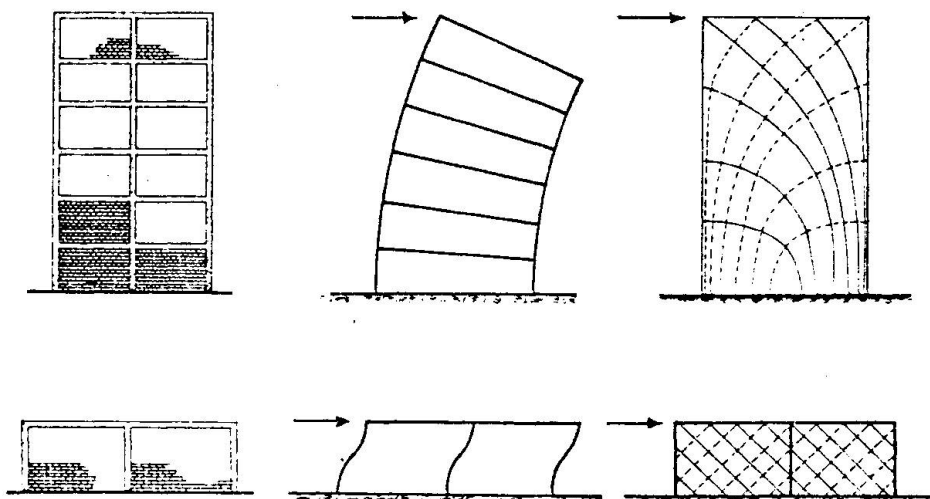

Fig. 4

course (Rienzo).

The standard method by which each panel is individually substituted in the calculation by a diagonal connecting rod is thus not generally to be applied.

§ 5.- Topological model of a simply supported plate.

In order to use in those constructional systems the graph of a framework as an M^3 , it is necessary to define the line or the sub-graph (set of lines) corresponding to each of the bi-dimensional structures in question.

At scale 5 the M^2 for a plate supported at the ends can be a set of crosses of bars hinged in the points of contact, as Wyss has widely illustrated; at the 3-4 scale (fig. 5a,b), a discharging arch can be substituted for the plate and thus a single line in the graph; line which represents at the 3rd level of abstraction the complex of the compression isostatics. We need four lines in the graph if the traction isostatics are taken into account: i.e. one line after and four before the opening of the cracks which physically give origin to the discharging arch.

To conclude, we must compare the topological scheme derived in fig. 5b from the isostatics of fig. 5a (a plate supported at the ends), with the isostatics of fig. 4 (a plate acting as a corbel which represents a panelled frame stressed by horizontal forces); it will be easy to derive by comparison the corresponding topological scheme (M^3) for this frame.

Note also that seismic stresses can also produce an alteration of the texture of the material. It is clear that in such a case the phenomenon of the discharging arch survives approximately and hence the possibility of representing the wall with a single line of the graph until the static function of the panel is completely annulled.

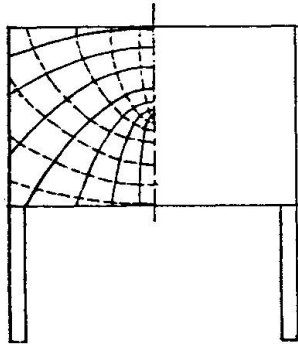

Fig. 5a

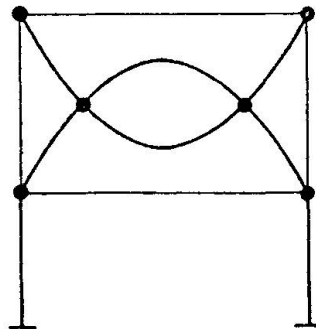

Fig. 5b

§ 6.- Topological model of the slab.

We try here to identify the M^3 of an elastic slab, a bi-dimensional structure stressed perpendicularly to its plane, meaning by M^3 the topological scheme of a set of rods (M^2) having the essential connections of the bi-dimensional structure assigned.

We accept the same limit set up for the plates in the preceding § 5, i.e. the M^3 for which we are looking should be valid for a single and specific condition of

load which however in this case is the most usual and practically the only one compatible with the definition: loads all normal at the plane of the slab. The technique is identical: to find a set of few rods which can take the place of the characteristic lines of the continuous mechanical scheme.

The difference is that whilst for the plate stressed by external forces acting in the middle plane we have taken into consideration the orthogonal network of isostatics (replacing it by several rods subjected to axial strain), for the slab we propose to substitute for the orthogonal network of the lines of max/min bending moments a small number of inflected beams.

Fig. 6a shows the well known picture of the lines of max-min moment for a square slab subjected to perpendicular load uniformly distributed supported by four beams at the edges: fig. 6b shows a scheme of inflected beams (B_1-B_2 , B_2-B_3 , B_3-B_4 , B_4-B_1 ; B_1c , B_2c , B_3c , B_4c) which we will suppose equivalent to the slab: to which we add the beams of support and the pillars placed at the vertices. Considering fig. 6b as a sub-graph, we shall have indicated a way of inserting sub-model M^3 of an inflected slab into the graph of the connections of a complex structure, made up of slabs and beams.

It is interesting to observe that from this M^3 can be deduced an M^2 (mechanical scheme) of the slab under examination, no longer in elastic regime but at limit state. We have in fact traced in fig.6c the dual hypergraph of the graph which represents the slab (cp. CE 188) or, if preferred, the dual graph point-line according to Nakajima.

In this every line of the original graph is replaced by a dot (which represents the section in which the beam represented by the said line in the original graph bears the limit value of the moment) and every node is replaced by a line. These lines (fig. 6d) represent the lines of fracture which are typical of the slab supported at the edges.

Fig. 6a

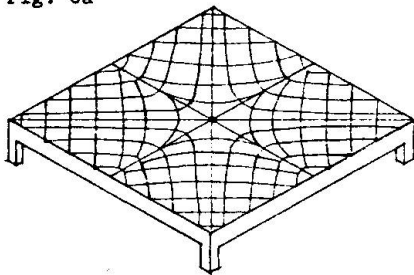

Fig. 6b

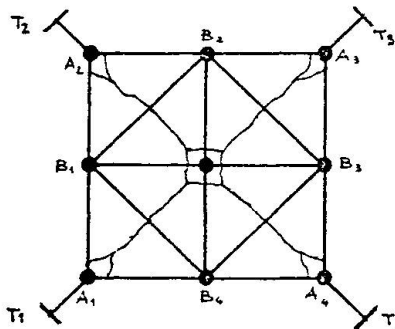
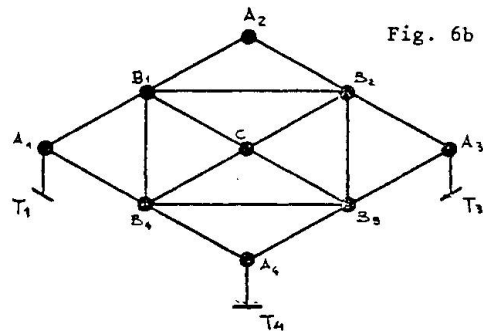

Fig. 6c

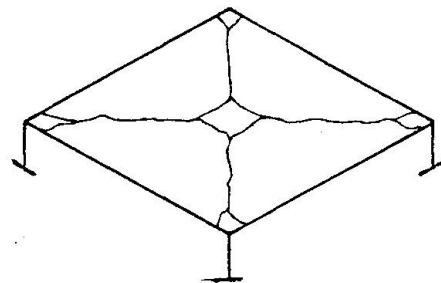

Fig. 6d

The second example refers to a mushroom floor. For this the isostatics are given in fig. 7a and the graph in fig. 7b. Fig. 7c shows the dual graph for a

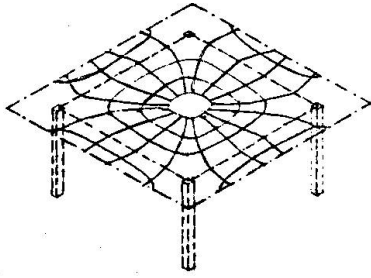

fig. 7a

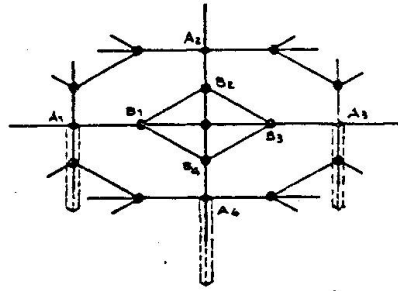

fig. 7b

generical field of the continuous slab and part of the adjacent fields. Then in fig. 7d the lines of fracture of a single field with some adjacent elements have been constructed.

It is also interesting to observe the repetitive symmetry of the dual graphs of fig. 7c which represent, superimposed, the abstract models (monodimensionalised) respectively of the elastic model and of the limit model of the mushroom floor.

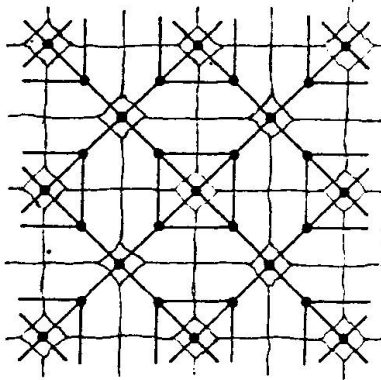

fig. 7c

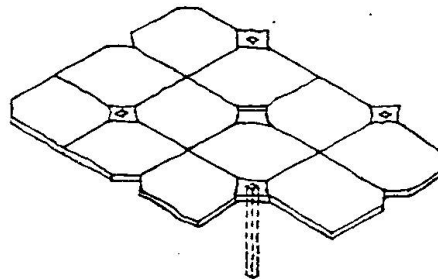

fig. 7d

§ 7.- Observations on the modelisation.

Lately we have compared the graphs representing the repetitive structures and the tessellations of the plane or of the space. Analogous observations have been made for some time for elastic frames and serve to explain, for these last and for continuous beams, the continuing form of the matrices of the systems of linear equations which represent them (CE 62).

From what has been said clear indications can be inferred analogously on the systems of equations relative to continuous slabs.

We now recall that in § 5 and 6 we limited ourselves to defining, both for the slabs and the plates, some M^3 which correspond to only one of the possible conditions of load and that, in the M^2 made up of rods or of beams (figs. 5b and 6b, 7b respectively), we built resistant mechanisms in which we show up only the connections acting in the specific conditions of restraints and loads.

In order to represent a generic and complete picture of the connections in a slab or plate with a mechanical scheme (M^2) or a topological one (M^3), without emphasizing any particular conditions of loads, it is necessary to bear in mind the tensorial nature of the mechanical models of the bi-dimensional structures.

This, together with the hypothesis of geometrical and mechanical linearity, allows us to substitute for the continuous bi-dimensional M^2 a triangular tessellation of the plane or of the surface under consideration (fig. 8).

In other words the more general graph of a bi-dimensional structure, restrained and stressed in any possible way, is made up of a set of lines disposed according to this tessellation and along each of which is transmitted a bending moment or an axial strain according to whether we are dealing with an M^3 relating to a slab or a plate.

There remain to be studied the relationships existing between the model of fig. 8 and the specific ones illustrated in figs. 5,6,7 for particular conditions of load and for this the concept of "scale" introduced in § 2 is valid.

If the supporting surface of the bi-dimensional continuous models is not flat but curved the considerations made in § 4 of part I of this study (CE 220) are brought into use.

§ 8.- Conclusion.

The few examples inserted in these pages are intended to introduce a simple procedure for the structural analysis of existing buildings, a procedure which will be used in a future work on static restoration design: the methodology described is in fact based, as in CE 215, on the comparative and global study of the static and topological-static models of buildings.

Bibliography

- Th.Wyss, Die kraftfelder in festen elastischen Körpern, Berlin 1926.
- G.Guerra, Statica e tecnica costruttiva delle cupole antiche e moderne, 1958 (CE 50).
- G.Guerra, Le applicazioni della teoria dei grafi alla scienza delle costruzioni, 1961 (CE 62).
- G.Guerra, La demolizione dell'ospedale di S.Leonardo in Castellammare di Stabia, 1962 (CE 71).
- S.J.Fenves, Network-Topological Formulation of Structural Analysis. - ASCE-ST Proceedings, Aug. 1963.
- I.Nakajima, Modello matematico nei problemi di progettazione e produzione architettonica. - Kenchiku-Zasshi, 1963.
- G.Guerra, La cupola della chiesa del Gesù Nuovo in Napoli, 1967 (CE 118).
- G.Guerra, La scelta dello schema strutturale di un hangar con l'uso dei grafi, 1967 (CE 120).
- G.Guerra, Principi di analisi edilizia e cenni sulla metodologia della progettazione, 1974 (CE 183).
- G.Guerra, I.Rienzo, R.Ambrosio, Su alcune applicazioni della teoria degli iper grafi nella progettazione edilizia, 1975 (CE 188).
- I.Rienzo, Metodo rapido di restituzione da fotografia per il rilevamento degli edifici, 1976 (CE 196).
- A.Cananzi, Il disegno automatico della prospettiva e l'eliminazione delle linee nascoste, 1976 (CE 201).
- G.Guerra, Deficienze costruttive e tecniche di risanamento delle ossature murali, 1977 (CE 202).
- G.Guerra, Systematic study of building considered for rehabilitation, 1977 (CE 215).
- A.Iannaccone, Restauro della chiesa del Monte Calvario in Foggia, tesi di laurea non pubblicata (1978), relatori: G.Guerra ed I.Rienzo.

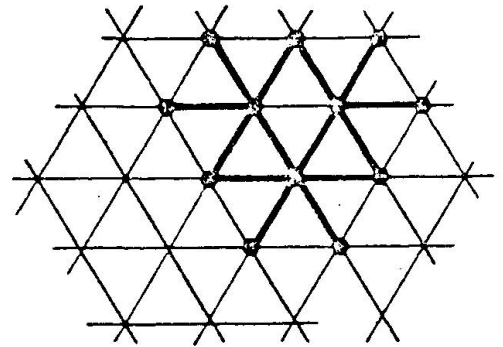

Fig. 8

Leere Seite
Blank page
Page vide

2nd Session: REPAIRS AND RECONSTRUCTION OF THE STRUCTURES

DISCUSSION

Paper 2/2: S. ALBANESI, P. BEER, R. GIACCHETTI, V. GUIDI, G. MENDITTO - ITALY

"Structural Repair of Monumental Masonry Buildings"

CROFTS

I would like to ask if you had any problem in drilling these very long holes to make certain that the drill holes went in the right place and did not veer off to one side or the other.

MENDITTO

The drill can depart from its course owing to its flexibility and its dead load when it meets different or differently arranged materials (i. e. stones, oblique faces of stones, elements of existent stirrups, points of contact between the stonework and the wood, etc.). In this case one inserts some little steel springs, normally arranged at the distance of 3 ÷ 4 metres from each other, through holes made for this purpose in the stonework in order to check that the way of the drill is in the right direction.

VELKOV

I would like to ask you concerning the concept of the repair, because sometimes you checked the model of the structures. Did you use the system of repair only to increase the resistance or also to increase the ductility? What was the principal concept of the repair? Did you make any analytical or experimental research in that connection, how to improve, how to increase the ductility?

PETROVSKI

I think that the repairing of historical monuments or of old buildings which are still in use poses the same problems. These types of structures survive for many centuries experiencing probably a great number of smaller earthquakes; they survive them with small or severe damage. There is really need to make structural changes to increase the ductility or strength of these structural systems? In my opinion it is almost unacceptable to increase the ductility, or it is very difficult; it is simply not feasible, not economical. I

would say that it is essential that we increase the strength of these structural systems and do not change their dynamic properties, because the empirical knowledge upon which our science is mostly based, is that they really survive for centuries.

MENDITTO

A proper repair requires a preventive historical knowledge in order to outline the structural pattern of the period techniques and the possible distributive and structural changes undergone by the masonry during its life. Such point of view is particularly important in order to outline volumetrical and distributive changes. Almost always the lack of original technical works turns the researches to not always satisfactory analyses. As matter of fact these researches must be confined within definite limits because of the size of the construction and the need of not modifying some monumental features (i. e. decorated floors) and the equilibrium of the construction, often already heavily damaged by the earthquake. A careful knowledge of the construction behaviour is also required at both technological and static level. This field disregarded for a long time because of the concrete technique nowadays re-opens to operators of the field. Fortunately a wide part of the traditional culture in masonry survives though it is prevalently empiric. The main goal of some remarkable researches is to check these principles and to arrange them into an organic theory. In Ancona we are working in this direction with a view to suggesting some behaviour models that we are carrying out with the advanced techniques of the structural analysis (i. e. finite elements). Of course some remarkable difficulties arise (i. e. the lack of proved constitutive laws for masonry) which we try to overcome with systematic and wide experiments.

It follows that several of the outlined repairs make use of a rational professional experience instead of sophisticated theories. Local and global checks performed as far as possible mainly to assure the statics and to restore the damaged constructions. Experiments were performed sometimes as far as possible. This is the case of Urbania episcopal seminary. Small masonry pillars were built using the same original technique and then crushed. The limit stress was 45 Kgcm^{-2} and $120 \div 135 \text{ Kgcm}^{-2}$ respectively before and after the repair. Our philosophy is to respect the architecture and to give at the same time to the construction a greater resistance than the initial one without any change in the whole elasticity.

It is pointed out that the suggested repairs consist mainly of sewing of different separated pieces using prestressed concrete tendons and mortars with additives. Therefore no change takes place in the original material where the elastic properties remain unaltered. Moreover the limited extent of the sewings cannot modify the original rigidity of the whole construction.

In our opinion a check of the whole ductility involves insuperable theoretical difficulties mainly because of the complex and not always known distributive pattern and of the tridimensional behaviour of these constructions.

An experimental approach can be attempted making use of an electric-dynamic exciter. Unfortunately the experimental results are confined to the chosen pattern of the repair. Moreover it is not possible to make a comparison with the original construction no more available because of the damages of the earthquake.

LANE

I have heard that steel was used for repairs in the case of the Parthenon and adjacent buildings in Rome. This was, I think, done in the 1930's. And I believe that now the deterioration of the buildings is greater because of the use of steel than it would have been without it, and I would like to know if you are satisfied that the use of steel in these cases will be satisfactory in the long term.

MENDITTO

Steel appears to be useful in the adopted repairs as it allows sewing and bracings otherwise impossible to realize because of its flexibility. We think the damage that Mr. Lane talked about depended upon oxidation processes, that took place because of lack of steel protection. These steels, even though exhibiting mechanical properties better than the current ties, were employed with the same technique as the ties. Consequently the masonry hygroscopicity and the presence of lime accelerated the oxidation of the steel, both by the reduction of its diameter (this process being quickened by the smaller sizes in respect of those of ties) and by mechanical breaking on the stonework. On the contrary we make use of a steel, protected against the oxidation by an oiled plastic sheath and by mortars with additives.

CROFTS

I saw on the slides you had some jacks. But the jacks appeared to be in the middle of the reinforced concrete. I wonder, did you lose the jacks or did you manage to recover them?

Dealing with this kind of buildings one is often very concerned about building movement. I wonder if you had any checks made on the movement of the building during repairs, using strain gauges or plumbing arrangements to make certain that any movement during repair was detected.

MENDITTO

The jacks are embodied in the concrete. When necessary (i. e. in the change of floor) the movements of the structure are followed during the repair by means of some stations of topographic survey, located in the most signif-

icant points of the structure. None dangerous movement is pointed out.

The injection pressure must be variable and limited by the strength of the masonry type. Also the tensile stress of tendons is related with the sizes of anchorage plates. The latter depend upon the architectonic requirements (possibility to dissimulate them) and the strength of masonry.

VELKOV

Concerning the increasing of the resistance: did you check anything which is connected with the foundation and the pressure in the soil, because with this repairing it is very clear that you increase the resistance of the whole structure. What will happen in the soil condition in the next earthquake, and also with the redistribution of the damage in the structure?

MENDITTO

We always worked in order to keep the same load distribution on the foundation to improve at the same time the ground with a sewing work (i. e. the use of micropoles). In all cases the efficiency of the whole structure and the interaction between the foundation and the overhanging structure were checked.

It is very hard to foresee the construction behaviour at next earthquake, since the earthquake features cannot be foreseen. At most some inertial effects can be simulated like those derived from the earthquake (i. e. by suitable adjustment of the road traffic, by controlled explosions, etc.) in the structure and in the ground and afterwards the dynamic behaviour both of the repaired structure and the improved ground can be pointed out by the recording vibrations. In this way we have experimental data about proper modes of structure vibrations. The latter transferred into a suitable mathematical behaviour model may supply useful information with regard to the dynamic response of the whole structure when the acceleration spectrum of the design earthquake is known.