

Crack control in concrete structures

Autor(en): **Leonhardt, Fritz**

Objektyp: **Article**

Zeitschrift: **IABSE surveys = Revue AIPC = IVBH Berichte**

Band (Jahr): **1 (1977)**

Heft S-4: **Crack control in concrete structures**

PDF erstellt am: **20.09.2024**

Persistenter Link: <https://doi.org/10.5169/seals-43581>

Nutzungsbedingungen

Die ETH-Bibliothek ist Anbieterin der digitalisierten Zeitschriften. Sie besitzt keine Urheberrechte an den Inhalten der Zeitschriften. Die Rechte liegen in der Regel bei den Herausgebern. Die auf der Plattform e-periodica veröffentlichten Dokumente stehen für nicht-kommerzielle Zwecke in Lehre und Forschung sowie für die private Nutzung frei zur Verfügung. Einzelne Dateien oder Ausdrucke aus diesem Angebot können zusammen mit diesen Nutzungsbedingungen und den korrekten Herkunftsbezeichnungen weitergegeben werden. Das Veröffentlichen von Bildern in Print- und Online-Publikationen ist nur mit vorheriger Genehmigung der Rechteinhaber erlaubt. Die systematische Speicherung von Teilen des elektronischen Angebots auf anderen Servern bedarf ebenfalls des schriftlichen Einverständnisses der Rechteinhaber.

Haftungsausschluss

Alle Angaben erfolgen ohne Gewähr für Vollständigkeit oder Richtigkeit. Es wird keine Haftung übernommen für Schäden durch die Verwendung von Informationen aus diesem Online-Angebot oder durch das Fehlen von Informationen. Dies gilt auch für Inhalte Dritter, die über dieses Angebot zugänglich sind.

Crack Control in Concrete Structures

Limitation des fissures dans les ouvrages en béton

Begrenzung der Rissebildung in Betonbauwerken

Fritz LEONHARDT

Consulting Engineer, em. Prof.
Institut für Massivbau, University of Stuttgart
Stuttgart, GFR

SUMMARY

Cracks in Concrete structures are almost unavoidable and more often caused by restraint forces than by loads. They are harmless for serviceability, durability and safety of structures if the crack width is limited. The interior proceedings at cracking are analysed for derivation of crack width formulae. Charts for practical design of reinforcement to meet requirements for crack limitation are given in a few examples. Crack width limitation without reinforcement for massive concrete structures is described.

RÉSUMÉ

La fissuration des ouvrages en béton est plus souvent due aux déformations imposées qu'aux charges. Elle ne peut pas être évitée, mais en général elle n'affecte pas la serviceabilité, la durabilité et la sécurité des ouvrages à condition que la largeur des fissures soit limitée. Les jeux des efforts intérieurs se produisant lors de la formation de telles fissures sont examinés et analysés en détail. A titre d'exemple, quelques abaques sont données pour l'application pratique permettant le dimensionnement des armatures en respectant les limites exigées pour la largeur des fissures. Dans les constructions massives, il est également possible de limiter la largeur des fissures à l'aide d'une faible précontrainte en omettant toute autre armature.

ZUSAMMENFASSUNG

In Betonbauwerken werden Risse häufiger durch Eigen- und Zwangspannungen verursacht als durch Lastbeanspruchungen. Risse sind fast unvermeidbar, sie sind für die Gebrauchsfähigkeit, Dauerhaftigkeit und Sicherheit der Bauwerke in der Regel unschädlich, wenn die Rißbreite auf ein kleines Maß beschränkt wird. Die inneren Vorgänge an Bewehrungsstäben beim Entstehen solcher Risse werden im Detail beschrieben und analysiert. Für den Ingenieur in der Praxis werden Kurventafeln zur Bemessung von Bewehrungen für geforderte Grenzen der Rißbreiten beispielhaft gezeigt. In massigen Betonbauteilen können Rißbreiten auch ohne Bewehrung durch eine mäßige Vorspannung begrenzt werden.



1. CAUSES AND SIGNIFICANCE OF CRACKS

Concrete has a high compressive but a low tensile strength. Small tensile stresses can easily cause cracks but these cracks are harmless for serviceability, durability and safety of our structures as long as they remain hair cracks, i. e. as long as the crack width remains under 0.2 to 0.4 mm depending on the environmental conditions. Only in tanks, vessels or other containers for liquids or gases which must be tight, it is necessary to avoid cracks.

There has been much research on corrosion protection for steel embedded in concrete during the last 30 years, which dealt also with the question if cracks in concrete have influence on this corrosion. The researchers agreed more and more that cracks up to a width at the surface of 0.4 mm do not increase corrosion if the concrete cover is at least 25 mm related to bar diameters smaller than 20 mm. Therefore, the limitation of crack width seems to be primarily a matter of good appearance of concrete structures, because cracks which are easily visible, look for most people, mainly also for clients, like the beginning of destruction and are therefore detrimental to the reputation of the engineers.

Good appearance as the main reason for limiting crack width does not sound very convincing, nevertheless it is indeed important to establish and observe good rules for limiting crack width in the future. Wide cracks indicate in most cases poor design quality in detailing of reinforcement, they indicate also a danger for the safety of the bond between reinforcing bars and concrete and so it is not only corrosion protection and appearance, which enforce crack width control.

Many engineers still believe that cracking can be avoided if the tensile stresses of concrete due to loads are kept well below the tensile strength of concrete. Therefore, in most codes we find limitations of such tensile stresses, for instance for prestressed concrete structures. This opinion is wrong. Most cracks are primarily caused by tensile stresses due to internal or external restraint produced by temperature or shrinkage differentials. Temperature plays a much more important role in causing stresses than most engineers are aware of.

The main danger for cracking arises during the first days of the life of a structure, especially if the thickness of the concrete member is large. It is well known that the hydration of cement develops heat and, therefore, heats the concrete up during the first hours after placing. Inside thick concrete members temperatures have been measured up to 80 K, giving a large difference against the air temperature at the surface which may be 10 or 20 K. In this young age the tensile strength of the concrete is still very low and the tensile stresses due to such temperature differentials can easily rise above the strength and cause cracks, at least micro-cracks between coarse aggregates and mortar (fig. 1). These early micro-cracks reduce, of course, the final tensile strength. This is the reason why we often find the tensile strength in structures being far below the tensile strength which we measure at test specimens in the laboratory.

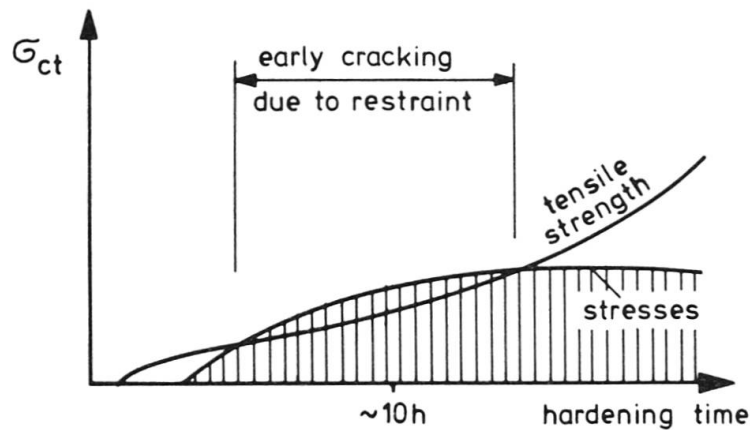

Fig. 1 Development of the concrete tensile strength and possible restraint stresses in the concrete due to cooling (ΔT)

Therefore, we cannot rely on tensile strength of concrete in structures for any primary requirements. On the other side there are many points in the structures where low secondary tensile stresses arise, for instance as splitting stresses due to bond between deformed bars and concrete, where we need a small amount of tensile strength and where we rely on it, so far without backstroke.

Also after hardening of the concrete, tensile stresses due to such internal restrained forces can easily exceed even a good tensile strength, if the structure is exposed to sunshine in change with cold nights or even with freezing temperature in winter time. Professor Otto Graf, the well known pioneer in testing materials of Stuttgart University taught as early as in 1928 that pieces of concrete with dimensions in one direction of more than 4 or 5 m exposed to open air in Middle European climate will get 1 or 2 cracks within the first two years, even if there are no load stresses. This knowledge was many times confirmed by cracks in concrete walls etc., but is still not yet in the mind of all engineers.

If we wish or have to avoid early cracks we must primarily avoid these causes. This means that for thick concrete members:

- we have to use a low heat cement and a low amount of cement,
- we may cool the aggregates or the mixing water for reducing the peak value of hydration temperature,
- we must avoid cooling of the concrete at the surfaces as it happens by stripping the forms early or keeping concrete wet by spraying it with cold water,
- we must protect the concrete against cold radiation at night and
- we must also protect the concrete against direct sunshine.

Shrinkage has similar effects like cooling and causes also tensile stresses near the surface. Therefore, concrete has also to be protected against early drying in air with low humidity.

Of course, we must also avoid early tensile stresses due to loads. Concrete cast in situ should remain on the centering as long as possible and prefabricated members should be stored in a way which keeps stresses due to own weight very low.

All these rules for avoiding early cracks belong to concrete technology and construction know-how. But they should also be known to the design engineer.

If we have to build structures of some size, which must be kept without cracks, we have only one way to do it, this is to compensate the tensile stresses, caused by load + restraint forces, by compressive stresses, produced sufficiently early by prestressing forces or, in other words, to use prestressed concrete.

Cracks cannot be prevented by reinforcement as many engineers believe. Reinforcing bars can only prevent the opening of cracks and they can enforce small spacing of cracks and hereby small crack width.

2. TYPES OF CRACKS

If a prismatic reinforced concrete member is tensioned, then the whole concrete area will crack, we call this "separating cracks" (fig. 2 a).

For limitation of crack width, two types of separating cracks have to be distinguished: crack by tension with free development of strain due to steel stress $\sigma_S = \frac{f_{ct}}{\rho_t}$ and cracks caused by bending or shear in webs where strain is limited by main longitudinal steel chord (strain diagram) and σ_S depends on distance to neutral axis or web tension due to shear.

If we apply bending to a reinforced beam, we get bending or flexural cracks which begin at the tensioned face and end near the neutral axis (fig. 2 b).

If such a beam is strongly reinforced and has a depth of more than about 40 cm, then closely spaced bending cracks tend to join to web cracks with a larger spacing which might be called "forking cracks" (fig. 2 c). Their crack width can be very large, if there is no sufficient longitudinal reinforcement in the web. Such forking cracks can also be in thick walls under tension, if the reinforcement near the surfaces is strong (fig. 2, c 2).

In slabs we get sometimes short cracks between the bending cracks which are caused by internal bond cracks which go through to the surface. We might call them secondary or bond cracks (fig. 2 d). Internal bond cracks are described later (fig. 5).

In beams with shear forces we get shear cracks with an inclination between 25 and 50° towards the axis of the beam (fig. 2 e). These shear cracks can begin as flexural cracks or inside the web area. Torsion causes similar inclined cracks, crossing the whole depth of all faces of prismatic members.

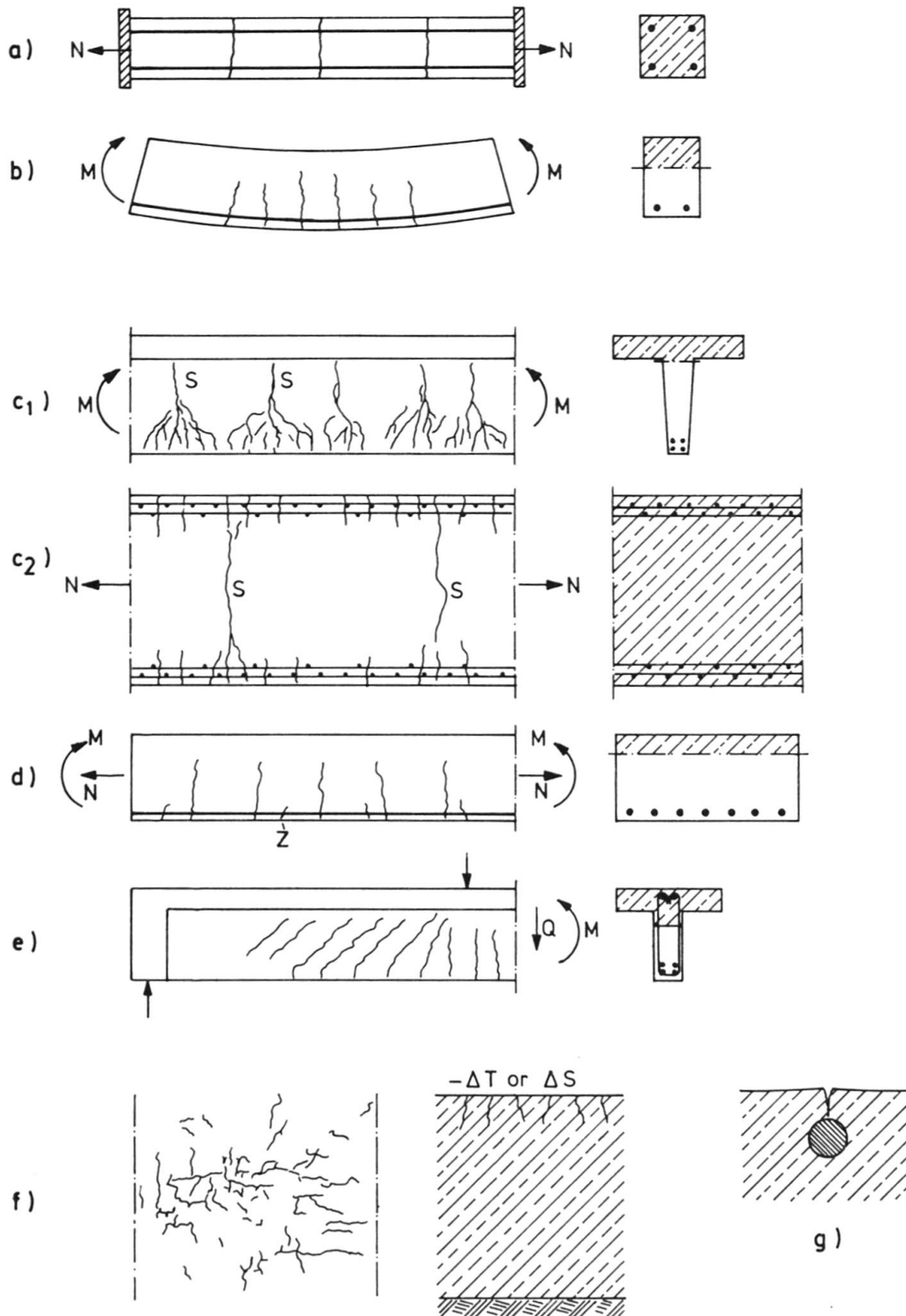

Fig. 2 Types of cracks

a) Separating cracks

b) bending cracks

c) forking cracks (S)

d) secondary or bond cracks (Z)

e) shear cracks

f) surface cracks

g) longitudinal cracks along reinforcing bars



A harmless type of cracks are surface cracks without any special direction which usually are not deep, in some cases only a few millimeters deep (fig. 2 f). We find them often in massive concrete structures with concrete having too high quantities of fine aggregate, water and cement.

A dangerous type of cracks is the one which shows up along reinforcing bars, caused by the settlement of deep fresh concrete (fig. 2 g). It is mainly found above thick bars, if the concrete had too much slump and was rather deep. Similar longitudinal cracks along thick bars can be caused by splitting forces due to bond stresses.

Micro-cracks are not mentioned here, because they are not relevant for crack width limitation.

3. WHAT HAPPENS AT CRACKING?

A rectangular beam of reinforced concrete under axial, uniform tension cracks when the tensile stress reaches the tensile strength. The tensile force which was carried by the concrete $T = A_c f_{ct}$ must suddenly be taken over by the reinforcing bar, causing a jump of stress in the steel (fig. 3).

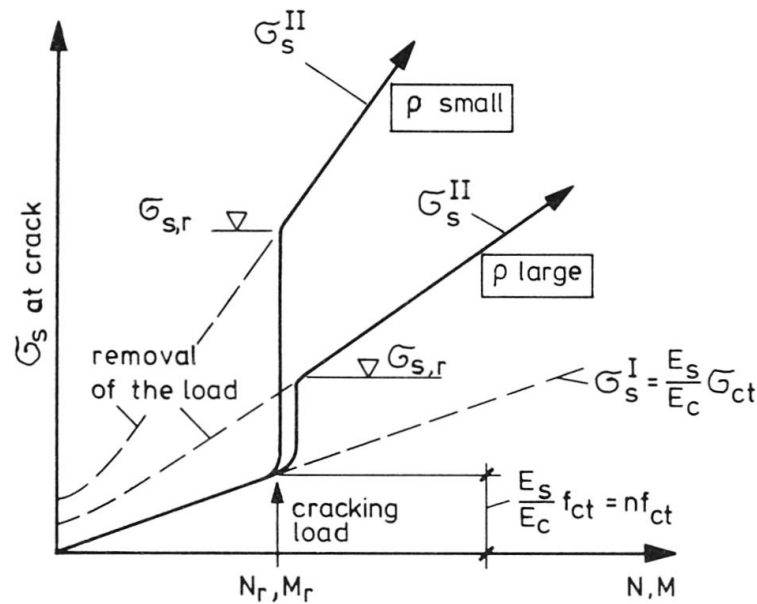

Fig. 3 Steel stresses in a crack of a prism under axial tension by increasing load for small and large $\rho_t = \frac{A_s}{A_{ct}}$.
 $\sigma_{s,r} - \sigma_s^I =$ sudden "jump" of steel stress at cracking.

The steel stress in the cracked section can easily be calculated:

$$\sigma_{s,r} = \frac{f_{ct}}{\rho_t} \quad \text{with} \quad \rho_t = \frac{A_s}{A_{ct}} = \text{geometrical ratio of reinforcement.}$$

The sudden jump of steel stress is $\Delta\sigma_{s,r} = \sigma_{s,r} - \frac{E_s}{E_c} f_{ct}$.

The small ρ_t gives a high jump of steel stress, a large ρ_t a low jump.

The steel stress in the beam under pure bending, all A_s at bottom side, but ρ referred to $A_c = b \cdot h$, is $\sigma_{sr} = 0.20 \frac{f_{ct}}{\rho}$, giving a smaller jump.

We may now look at the stress diagrams along a reinforcing bar in the vicinity of the first crack (fig. 4):

The bond stress τ_b must have a peak close to the crack on both sides of the crack. It decreases, following an e-function, till to the point where the tensile strains of concrete and steel are equal again. This length of active bond stresses is called the transfer length l_{tr} , it mainly depends on the bond quality of the reinforcing bars in the concrete.

The height of the peak of bond stresses near the crack is influenced by the amount of the steel stress jump. A low jump can be transferred by low bond stresses, a high jump, however, leads to bond stresses beyond the bond strength and may even destroy the bond on a short length.

The tests of Professor Y. Goto [7] (fig. 5) give us an insight into what happens around cracks. High bond stresses lead to small internal cracks behind the ribs of the deformed bars. Small concrete teeth resist the interlock forces by flexural resistance of these teeth. This resistance decreases with increasing length of these small bond cracks, one or two of the teeth may almost loose their resisting strength. This gives a length l_o of almost lost bond, for which I give a roughly estimated value for ribbed bars with standard rib sizes:

$$l_o = \frac{\sigma_{s,r} [\text{N/mm}^2]}{45} \phi \quad (1)$$

This value has to be checked by further tests, using the Goto method. It will be larger for smooth bars.

If the steel stress jumps up to the yield strength of the steel, then the bond is more or less destroyed at the first two or three of these Goto-cracks on both sides of the crack, giving a length of lost bond $l_o \approx 6 \phi$. Only in this way we can explain that the initial crack width at cracking can become between 0.4 and 0.8 mm as it was frequently observed under restraint forces if a so-called "shrinkage reinforcement" was placed only. In prestressed concrete beams with a too low amount of unstressed reinforcement and with grouted tendons, the length of lost bond in tendons was found to be about $30 \cdot \phi$ with stress-steel bars of 30 mm diameter, causing crack widths up to 0.9 mm at cracking (tests of H. Trost, Aachen).

If we have bending, then the sudden jump of steel stress is considerably smaller, only about 0.4, if we relate the reinforcing bars to the sectional area which is under tension i. e. to $\rho_t = A_s / b(h - x)$. If we have bending plus compressive longitudinal normal force like in prestressed concrete members, the sudden jump of steel stress will again be considerably smaller, if the ratio of rebars is kept the same or not too much lower (fig. 6 and 7).

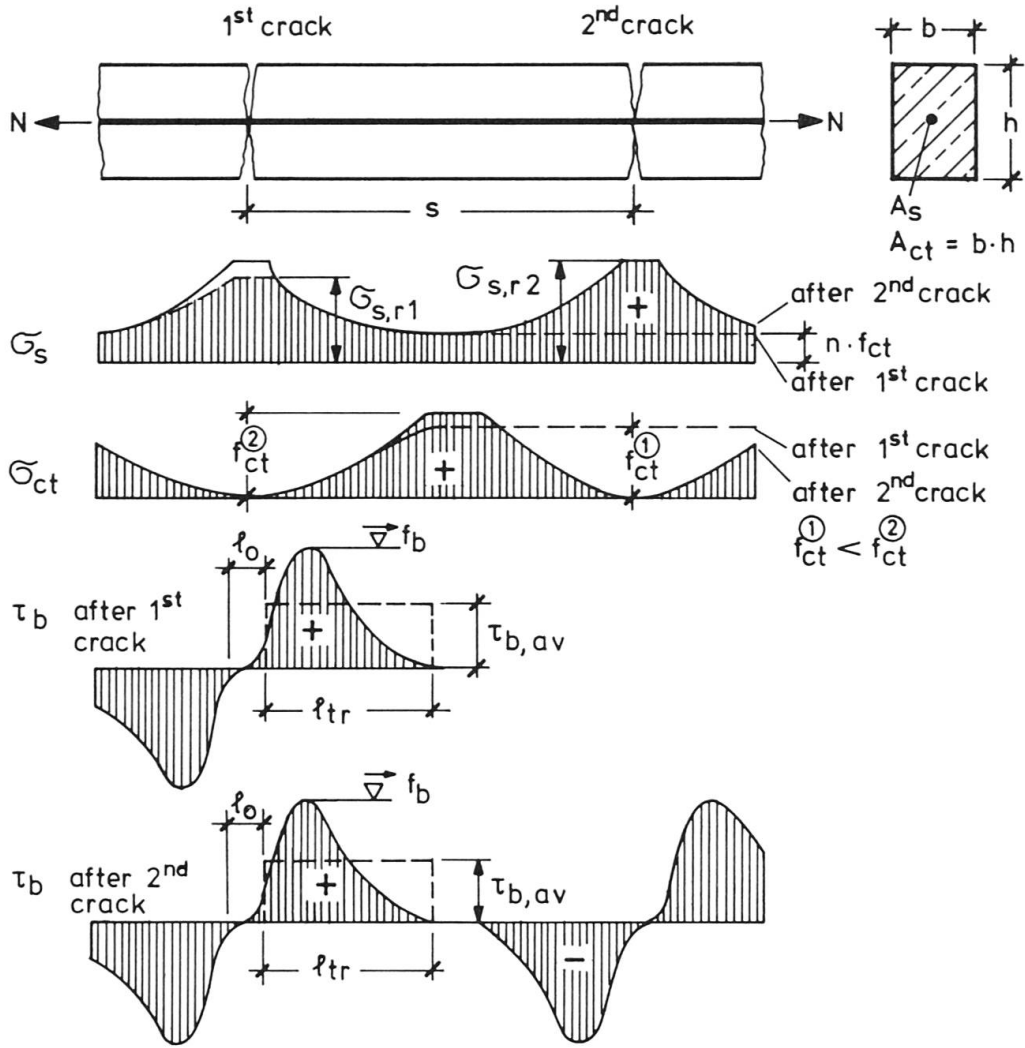

Fig. 4 Stresses along rebar in a r.c. prism under axial tension, after first and second crack (the scale of the stresses σ_s , σ_{ct} and τ_b is different)

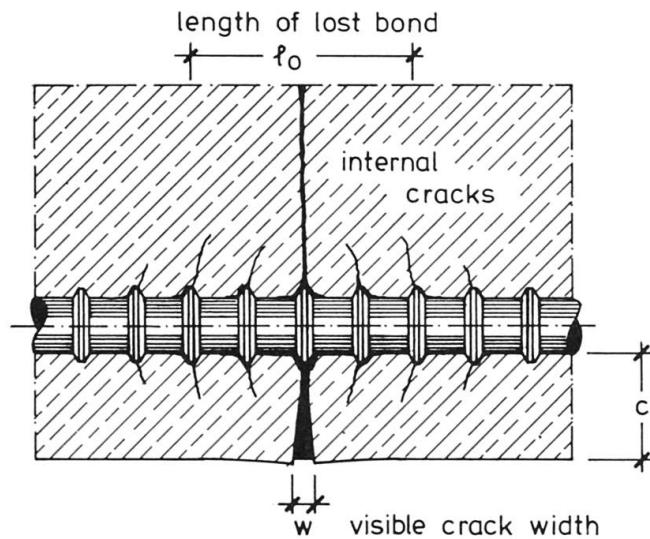

Fig. 5 Small bond cracks at ribs of rebars according to Y. Goto's tests

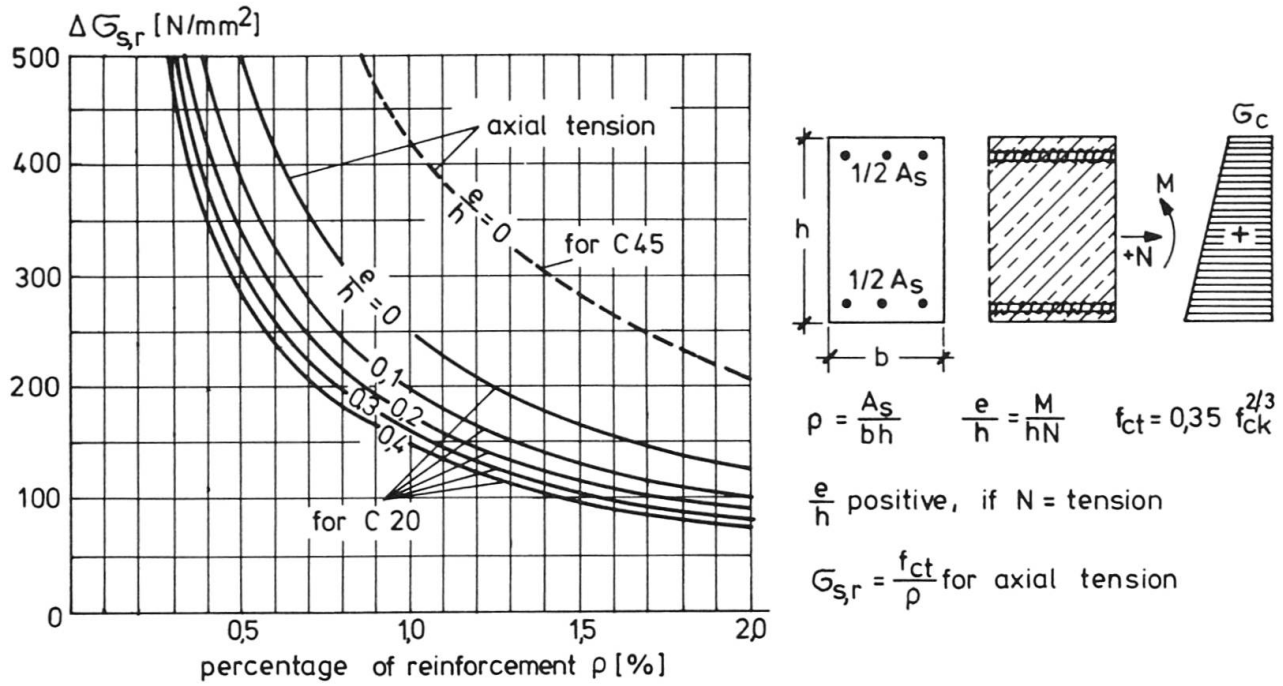

Fig. 6 Jump of steel stress $\Delta \sigma_{sr}$ at cracking in a r. c. prism under axial or eccentric tension for different ratios of reinforcement ρ

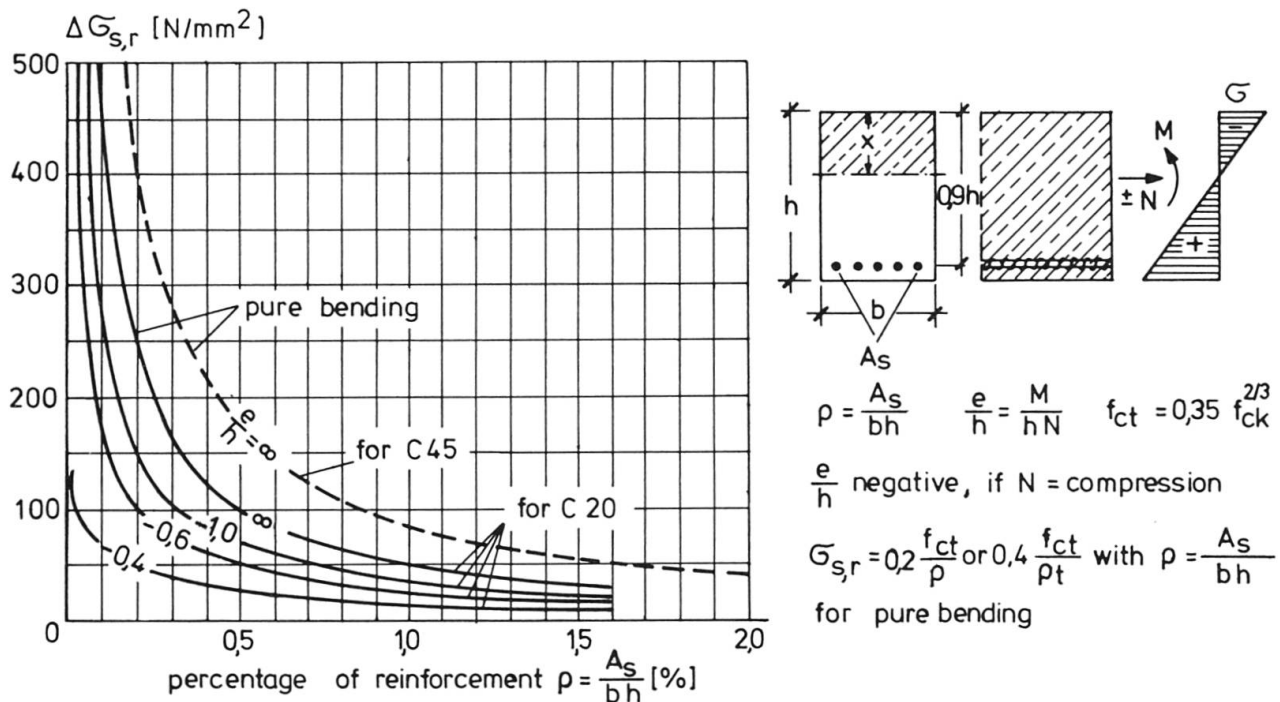

Fig. 7 Jump of steel stress $\Delta \sigma_{sr}$ at cracking in a r. c. beam under bending or bending with compressive normal force for different ratios of reinforcement ρ .

The stresses are lower, if referred to $\rho_t = \frac{A_s}{b(h-x)}$.



We find, that at cracking the sudden jump of steel stress depends very much on the kind of actions causing stresses, it is highest for axial tension and decreases if bending or normal compression interact. The curves show the great influence of the ratio of reinforcement and - with a dotted line - also the influence of concrete strength. For axial tension the steel stress can easily exceed the yield strength of high strength steel $f_{sy} = 420 \text{ N/mm}^2$ with percentages as high as 0.6 % for a concrete cylinder strength of 20 N/mm^2 and of 1.0 % for a cylinder strength of 45 N/mm^2 , assuming mean values f_{ctm} ; with the 95 % fractile of f_{ct} , the ratio percentages could be 40 % higher.

(According to CEB, 1977, tensile strength of normal concrete can be assumed to:

$$\begin{array}{l} \text{mean } f_{ctm} = 0,35 f_{ck}^{2/3} \text{ [MPa]} \\ 95 \% \text{ fractile} \quad 1.6 f_{ctm} \\ 5 \% \text{ fractile} \quad 0.6 f_{ctm} \end{array}$$

If we have bending plus compressive normal force with an eccentricity $e = \frac{M}{N} \approx -0.6$ (fig. 7), then the same ratio of reinforcement may give a jump of steel stress of only about 1/10 of the yield strength. This great difference of steel stress at cracking must, of course, have a considerable influence on the bond forces, on the length of lost bond, on the transfer length, and, therefore, also on the initial crack width at the moment of cracking and the further development of this width under increasing load or restraint forces.

It must be pointed out here that this sudden jump of steel stress must also have influence on the function $f(\tau_b, \epsilon_m)$ between bond stresses and the elongation of the steel bar embedded in concrete. The testing procedures, like the different pull out tests, which we use so far for measuring this function, have no similitude to the proceedings which actually happen at cracking in structures and can, therefore, not give a correct basis for crack width theories. New methods of testing, imitating this sudden jump of the steel stress must be developed for getting the correct physical data.

4. WHICH CRACK WIDTH MUST BE LIMITED

Goto's tests (fig. 5) show that the crack width decreases from surface to the bar so that the cover c must have an influence on the crack width, measured on the surface of the concrete. A crack width at the surface of 0.3 mm may correspond to 0.1 or 0.05 mm width at the bar depending on c and ϕ . This can explain the small effect of corrosion. Crack width increases also with the distance of the crack point transverse to the bar [8]. This is a reason for the large scatter of measured values of crack width, which is greater in slabs with larger spacings of bars than in T-beams with closely spaced bars.

If appearance is important, then the crack width at any point of the cracks must be kept under control which can only be reached by small spacings of the bars, depending on the amount of acceptable crack width. The acceptable crack width for a structure should be a matter for agreement between client and designer and not a strict requirement in a Code.

If corrosion is important, then the crack width at the crossing of the bar counts and the admissible amount depends on the cover which should be related to the

bar ϕ with $c \cong k \phi$, $k \cong 1$ in dry buildings and $k \cong 2$ in humid corrosive environment. The cover of thick bars ($c > 40$ mm) should be protected by transverse thin bars, if corrosion must be considered.

5. PROPOSAL FOR DESIGN ANALYSIS

(Detailed derivation in [1])

The transfer length at a crack can be determined by

$$l_{tr} = \frac{f_{ct} A_{ct}}{\tau_{b,av} \Sigma u} + k_1(c, a) \quad (2)$$

A_{ct} = concrete area under tension before cracking

$\tau_{b,av}$ = average bond stress over the transfer length (see fig. 4)

Σu = sum of circumferences of rebars

$k_1(c, a)$ = representing spreading-out-length considering cover and bar spacing.

The $k_1(c, a)$ value depends on concrete cover c and spacing of the rebars a , it is the length in which stresses spread out from the crack. It may be assumed to

$$\begin{aligned} k_1 &= 1.2 c && \text{for } a \leq 2 c \\ &= 1.2 \left(c + \frac{a - 2 c}{4} \right) && \text{for } a > 2 c \quad \text{with } a \leq 14 \phi \end{aligned}$$

The ratio $f_{ct}/\tau_{b,av}$ is practically a constant, if at the peak of the τ_b curve the bond strength f_b is reached (true for most practical cases), making the transfer length independent of concrete quality. It was found

$$\left. \begin{aligned} k_2 = \frac{f_{ct}}{\tau_{b,av}} &= 0.40 && \text{for standard ribbed bars} \\ k_2 &= 0.74 && \text{for smooth hot rolled bars.} \end{aligned} \right\} \begin{array}{l} k_2 \text{ can be much} \\ \text{higher for very low} \\ \text{jump of steel stress} \end{array}$$

The second term of l_{tr} can be written with the percentage of reinforcement related to the tensioned area of concrete with a factor k_3 depending on the shape of the tensile stress diagram

$$\frac{A_{ct}}{\Sigma u} = k_3 \frac{\phi}{\rho_t} \quad \begin{array}{l} \text{with } k_3 = 0.25 \text{ for pure tension (rectangular stress} \\ \text{diagram)} \\ k_3 = 0.125 \text{ for pure bending (triangular stress over} \\ \text{depth of effective area)} \end{array}$$

With these coefficients, we can calculate the transfer length

$$l_{tr} = k_1(c, a) + k_2 k_3 \frac{\phi}{\rho_{t,ef}} \quad (\rho_{t,ef} \text{ see later}) \quad (3)$$



At the end of the transfer length, the tensile stress of the concrete can again reach the tensile strength and the next crack can occur. Therefore, the transfer length determines the probable crack spacing and gives one parameter for crack width calculation.

The transfer length depends on the ratio of rebars ρ_t which is related to the concrete area under tension A_{ct} , which will crack. This area is easily defined as the total area for pure tension (uniformly stressed) and for bending of members with small depth (< 300 mm), but for deeper beams for instance, where the center of gravity of the tension zone is much above the gravity point of the reinforcement (fig. 8 a), this total area $A_{ct} = b(h - x)$ would give wrong results.

We have to look at the crack pattern for such cases and find that there is only a rather small zone around the reinforcing bars in which they enforce the small crack spacing. Outside this zone the cracks have considerable larger spaces. Therefore, we have to introduce an "area of efficacy" $A_{c,ef}$ depending on the concrete cover, the vertical and horizontal spacing of bars as proposed in fig. 8. For concrete members under pure tension this affected area may be

Rules for area of efficacy $A_{c,ef}$

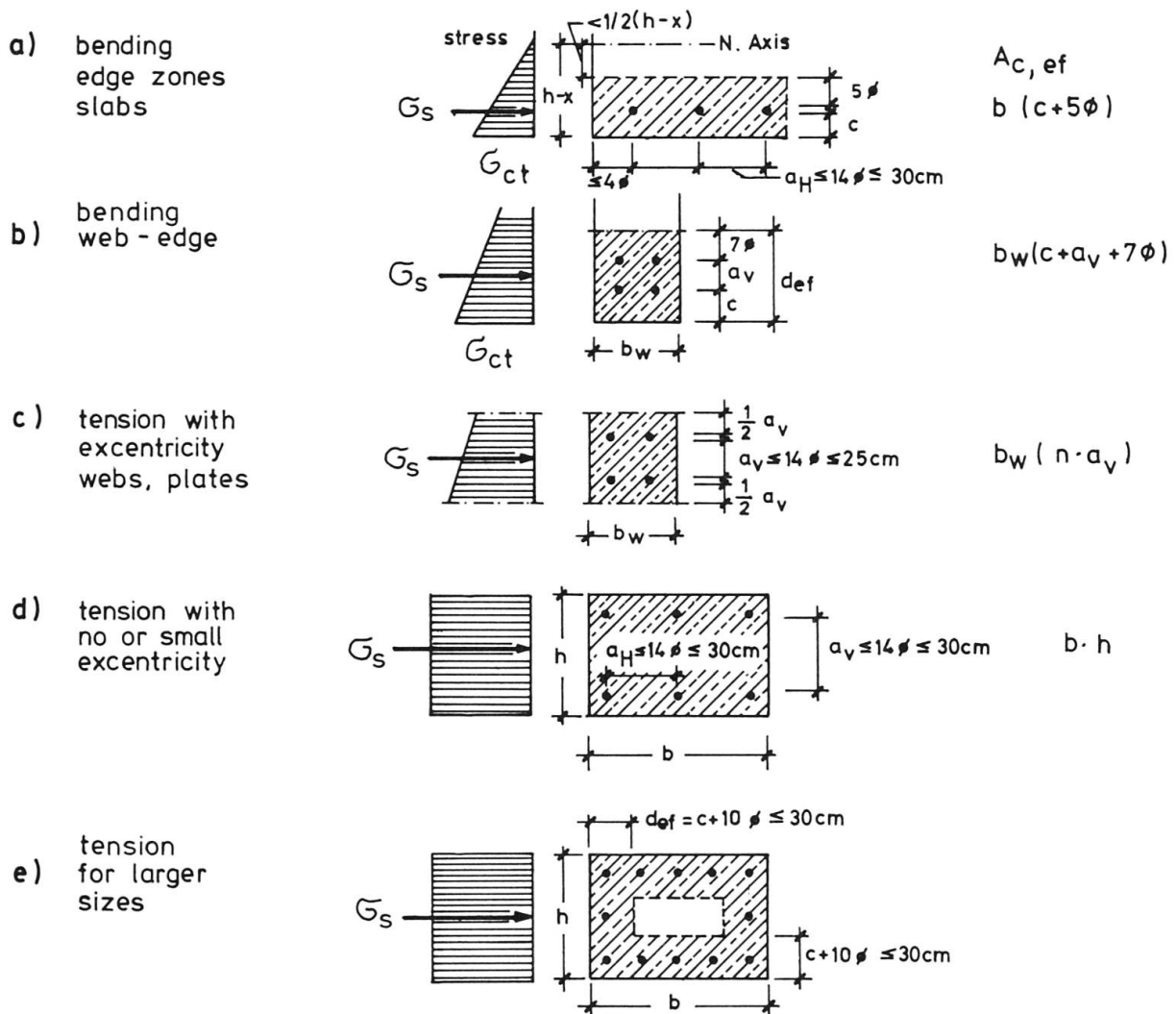

Fig. 8 Area $A_{c,ef}$ around reinforcing bars, in which the bars enforce small crack spacing. For dimensioning crack spacing and crack width ρ_t must be related to $A_{c,ef}$ and will be called $\rho_{t,ef}$

equal to the total cross sectional area, if separating cracks have to be expected. In thick members in which thermal stresses interfere with load stresses, a marginal zone of about $(c + 10 \phi) \cong 30$ cm thickness may be sufficient, because the thermal tensile stresses producing tension have their maximum near the surface and are compressive in the interior part.

In crack width formulae, the amount of reinforcement must, therefore, be related to this area of efficacy $A_{c,ef}$ as defined tentatively on fig. 8. The limits of bar spacings $a = 14 \phi \cong 30$ cm are based on Beeby's tests [8], but may yet be too large, however feasible for practical design.

If we increase the load after we got the first crack (fig. 4), there will be a second and a third and more cracks in more or less stochastic distances, just wherever the concrete happens to have a weak spot. However, at a certain load stage the number of cracks does no more increase, we get the so-called stabilized crack pattern (fig. 9) with some cracks having the minimum possible spacing which is equal to $\min s = 1/2 l_o + l_{tr}$. There is a large scatter of the crack spacing in structures and statistical evaluation led to coefficients between 1.3 and 1.8 for the 95 % fractile of the maximum crack spacing over the mean value, depending on the kind of action and angle between crack and rebar.

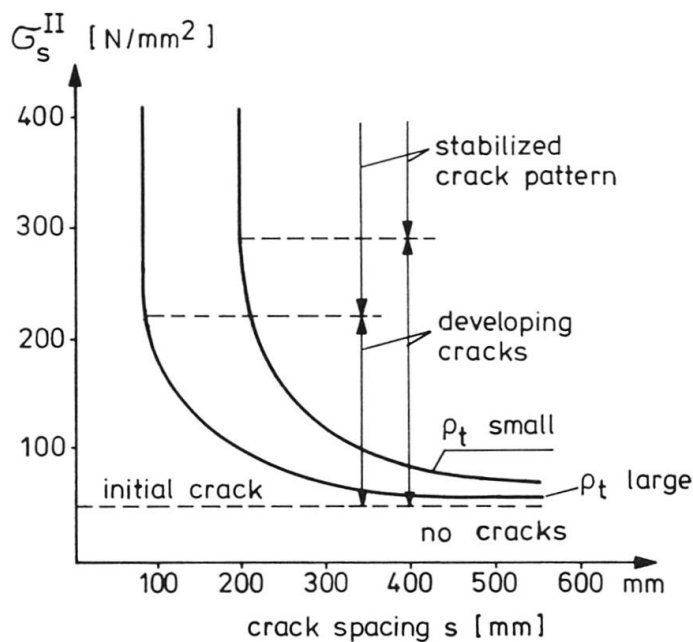

Fig. 9 Development of crack spacing and states of crack development for deformed bars (S 400) as a function of the increasing load represented by σ_s^{II} .

Most formulae for the crack width are so far based on the average crack spacing in the state of stabilized cracking, but this is no feasible base because in cases of restraint forces there may be only few cracks with large spacing, and in partially prestressed concrete, spaces of cracks increase with increasing degree of prestress because the bond stress τ_b remains below f_b and therefore k_2 becomes larger than 0.4. Simultaneously crack width decreases [4],



Therefore, crack width should be calculated from the sum of

$$l_o + l_{tr}$$

leading to

$$w = l_o \epsilon_s^{II} + l_{tr} \epsilon_m \tag{4}$$

where ϵ_s^{II} is the steel strain due to σ_s^{II} in the cracked section and ϵ_m is the mean steel strain of a reinforced prism, measured over the cracks regarding concrete tension contribution within the transfer length which can be found by tests only. A large number of such tests have been made in Stuttgart, for restraint forces by H. Falkner [5] and for load tension by F. Rostásy [6]. Fig. 10 gives a typical example of results. The concrete contribution, the so-called tension stiffening, is largest for low percentages of rebars and stresses close to the stress at cracking. It decreases with increasing stress.

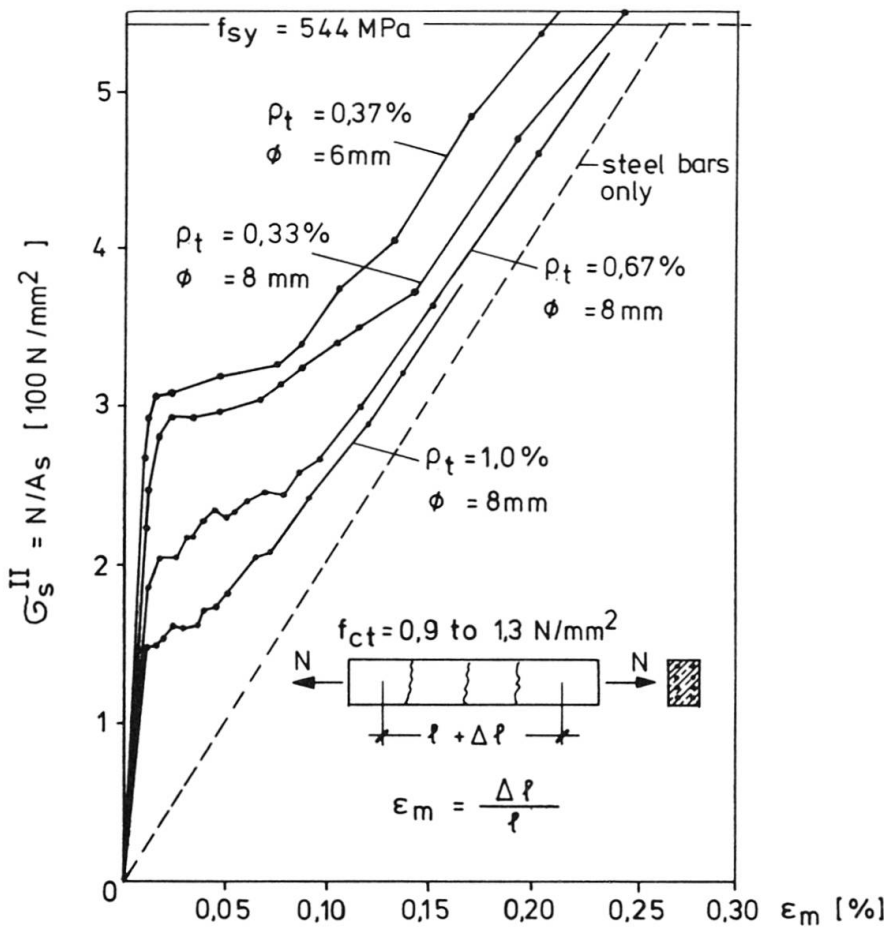

Fig. 10
Test results of stress-strain curves, found by axially loaded light-weight aggregate concrete members (CL 10 to CL 15) with different ρ_t and different spacing and ϕ of the reinforcement (Rostásy)

Idealized, we can assume a curve as shown on fig. 11. The max. value of tension stiffening is

$$\max \Delta \epsilon_s = k_6 \frac{f_{ct}}{E_s \rho_t} \quad \text{with } k_6 = 0.5 \text{ for axial tension} \\ \text{and } k_6 = 0.36 \text{ for pure bending.}$$

H. Falkner could prove [1] that by neglecting ϵ_{ct} , the factor k_6 can be eliminated and is obtained with

$$\epsilon_m = \epsilon_e^{II} \left[1 - \left(\frac{\sigma_{s,r}}{\sigma_s} \right)^2 \right] \tag{5}$$

with $\sigma_{s,r}$ = steel stress at cracking in cracked section, under the cracking load which causes $\sigma_{ct} = f_{ctm}$ in state I
 σ_s^{II} = steel stress at crack under considered design load stage.
 $\sigma_{s,r}$ includes the difference between pure tension and bending.

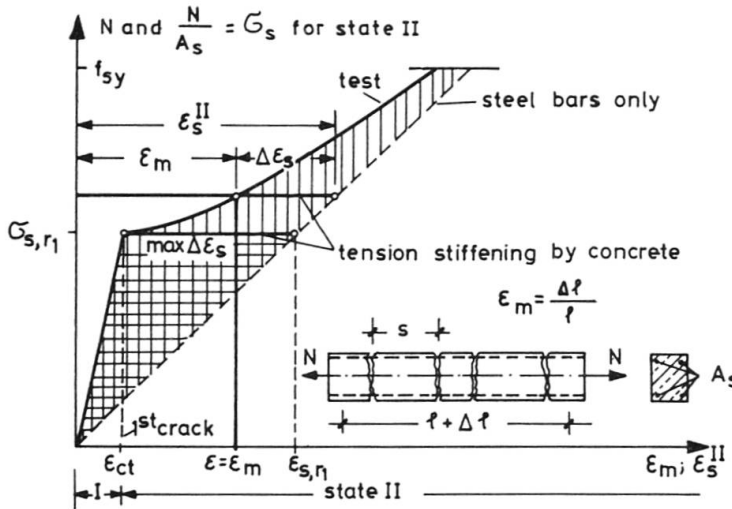

Fig. 11
 Idealized stress-strain curve of a reinforced concrete member and of the steel bars only. The horizontal spacing of both curves is marked with $\Delta\epsilon_s$ according to $\Delta\sigma_s$. This spacing shows the concrete tension contribution (tension stiffening) within the transfer length (Rostásy)

We have now all relations and parameters which we need for calculating the crack width at the first loading in cases where the cracks cross the rebars rectangularly. We recommend to base the assumptions for the tensile strength of concrete, for bond strength etc. on mean values and then use a scatter factor k_4 for getting w_{95} = 95 % -fractile of maximum crack width. This coefficient of variation k_4 was found to be roughly:

$$\begin{aligned} k_4 &= 1.4 && \text{for pure tension and moderate bar spacing} \\ k_4 &= 1.6 && \text{for bending.} \end{aligned}$$

So far much larger scatter factors have been offered based on statistics which include tests which did not consider reasonable design rules for crack control. It was also found, that the formulae and coefficients as suggested here lead to values, which correspond more to the 60 % fractile than to 50 % mean values. A slight overestimation of mean values by design calculation is on the safe side and sound, but it allows lower coefficients k_4 of variation for the 95 % fractile.

For load repetitions or sustained load, crack width increases by decreasing the tension stiffening value $\Delta\epsilon_s$ on fig. 11 with the factor

$$k_5 = 0.8 \text{ to } 0.4 .$$

The larger factor refers to high ratios of rebars and moderate loading, the lower one to low ratios and severe loading. It is difficult to define this factor more precisely for practical use. For smooth bars, $k_5 = 0.4$ to 0.2 can be assumed, because tension stiffening gets almost lost.

The maximum crack width can now be written with terms and factors given in the foregoing

$$w_{95} = k_4 l_o \frac{\sigma_s^{II}}{E_s} + k_4 l_{tr} \frac{1}{E_s} \left(\sigma_s^{II} - k_5 \frac{\sigma_{s,r}^2}{\sigma_s^{II}} \right) \quad (6)$$

with $l_{tr} = k_1 (c, a) + k_2 k_3 \phi / \rho_{t,ef}$ (see (3)).



A correction is necessary if the rebars do not cross the cracks rectangularly. This factor can be roughly assumed

$$\begin{array}{ll} \text{for } \alpha \cong 75^\circ & k_\alpha = 1.0 \\ \alpha = 45^\circ & k_\alpha = 1.6 \end{array}$$

with a linear interpolation for angles in between. These k_α should be checked by further tests.

6. INFLUENCE OF SHRINKAGE AND TEMPERATURE

In structures with great differences of thickness of members connected with each other, thin members (like bottom slabs of box girders between thick webs) can get tension due to differences in shrinkage and cooling temperature which can contribute to cracking and to crack width. The additional crack width can reach no higher values than about

$$\Delta w_{S,T} \approx 0.7 (l_o + l_{tr}) \Delta \epsilon_{S,T}$$

$\Delta \epsilon_{S,T}$ is the difference of shrinkage and temperature-strain of the thin member against the thick member. The $\Delta w_{S,T}$ has to be subtracted from the desired limit of w due to load stresses.

7. CHARTS FOR PRACTICAL DESIGN

The formula (6) for w_{95} is, of course, too complicated for the practising engineer. Therefore simple charts have been and should be further developed which allow to read the necessary design data directly.

There is first the Falkner diagram for tension caused by restraint forces which allows to find the necessary ratio of rebars $\rho_{t,ef}$ (fig. 12). It is assumed, that strains can develop freely, the curves can therefore not be used for separating cracks in webs.

The curves are based on the steel stress at cracking. If the stress increases by load later, then a correction has to be made which can be derived from equation (6) and is given in [1]. These diagrams are also available for light weight concrete [1].

More general charts were developed from the complete formula (6) by W. Dietrich (fig. 13) which allow to read the required $\rho_{t,ef}$ in percent for a chosen bar diameter and a fictive steel stress due to service load

$$\sigma_{s,w} = \sigma_s^{II} - \frac{43 \sigma_{s,r}}{\sigma_s^{II} \rho_{t,ef} [\%]} \quad [\text{N/mm}^2] \quad (7)$$

which includes average values for $k_3 = 0,2$, $k_5 = 0,6$ and $f_{ct} = 2 \text{ MPa}$.

Such charts should be made available in manuals for different concrete and steel qualities and especially for partial prestressing. They are the simplest way to make crack width control easy for the practising engineer. He should not be forced to open a new field of doubtful calculations.

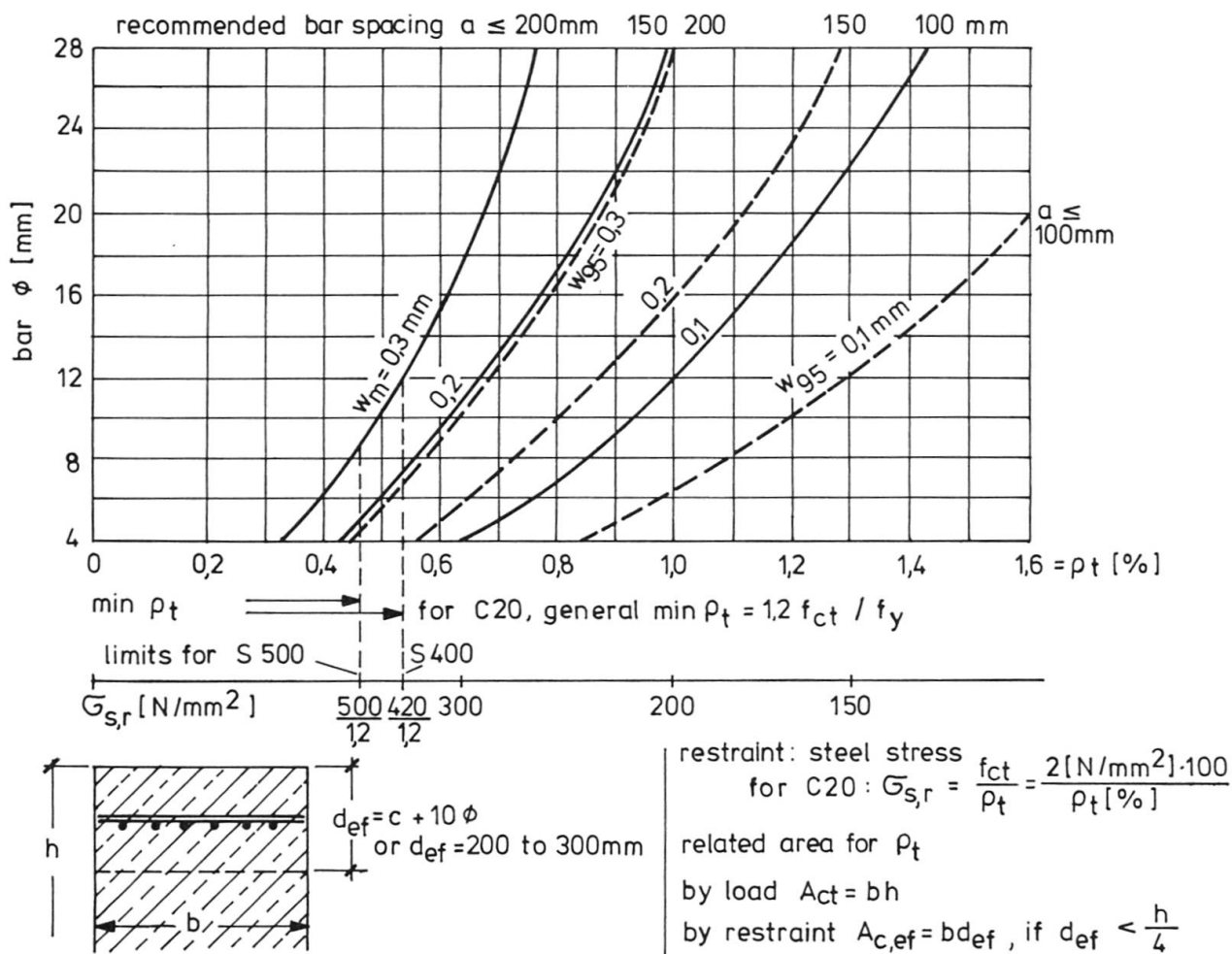

Fig. 12 Necessary percentage of reinforcement ρ_t for the required limit of crack width (w_m or w_{95}) assuming the diameter of the bars for axial tension due to load or restraint up to $1,2 \sigma_{s,r}$ concrete class C 20, for higher class $\min \rho_t = \frac{f_{ct}}{f_y}$ deformed bars S 400 or S 500 concrete cover 1,5 to 3 cm. Lower limits of ρ_t for restraint forces. Diagram valid for good bond - for not so favorable bond (bars on top) 30 % may be added to ρ_t (Falkner Diagram)

8. SHEAR CRACKS

Shear cracks are separating cracks with limited strain development (see para 2) crossing the total web thickness of girders. They can get a rather great width, if webs are thick and shear forces high and the usual shear reinforcement - vertical stirrups - are used which cross the shear crack under an angle of 45° to 60° . Thick bent up bars inside the web with large spacing help almost nothing to limit the crack width.

The main problem is to define the steel stress in stirrups for which crack width limitation must be calculated, because these stresses are not linearly proportional to the load. It is proposed to make use of an observation in hund-

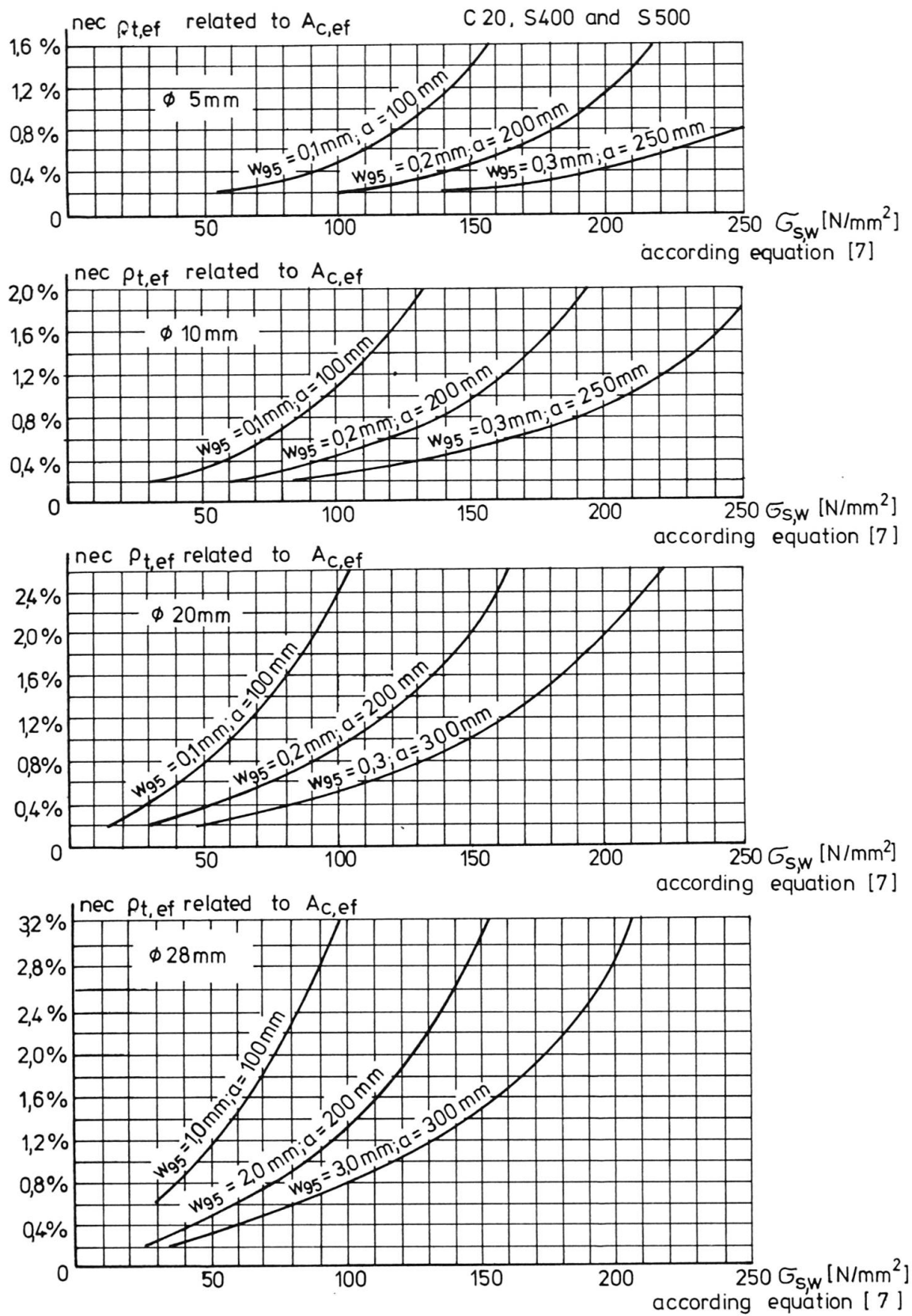

Fig. 13 Charts to find nec $\rho_{t,ef}$ for a chosen bar ϕ , a required limit of crack width depending on fictive steel stress according to equation (7)

reds of shear tests which allows to calculate this steel stress in stirrups to

$$\sigma_{s,st} = \frac{\tau_o - \tau_r}{\rho_v} \quad \text{with} \quad \rho_v = \frac{A_{s,st}}{b_w a_s} \quad (\text{fig. 14})$$

with $\tau_o = \frac{V}{b_w z}$ = nominal shear stress under service load $G + \psi Q$
 $\tau_r = 0.16 f_{ck}^{2/3} \approx 0.45 f_{ctm}$ = shear stress at shear cracking load (low fractile) (f_{ck} in N/mm^2).

This value can be increased in prestressed girders (see [1]).

These stresses refer to the first loading, the stresses increase, however, with repeated loading which is considered by a reduction of the subtraction value by 0.7. Therefore, crack width has to be checked for

$$\sigma_{s,st} = \frac{\tau_o - 0.7 \tau_r}{\rho_v} \cong 40 \text{ N/mm}^2 \quad (8)$$

With this steel stress, the crack width can be calculated, using formula (6), but with $k_5 = 1$. The load causing $\tau_o = 0.6 f_{ctm}$ can be assumed to give σ_{sr} . A comparison with test results gave good agreement. The limit of 40 N/mm^2 is given for caution's sake because actual service load stresses in stirrups can be very low, but also here restraint stresses may be involved. In some bridges, webs cracked mainly by thermal stresses. Shear crack-width verifications are, however, not necessary when $\tau_o < \tau_r$. The scatter factor should be assumed to be rather high with $k_4 = 1.6$, as long as no further test results are available with T-beams which were designed for limited crack width. (Most former shear tests have stirrups with too large spacing).

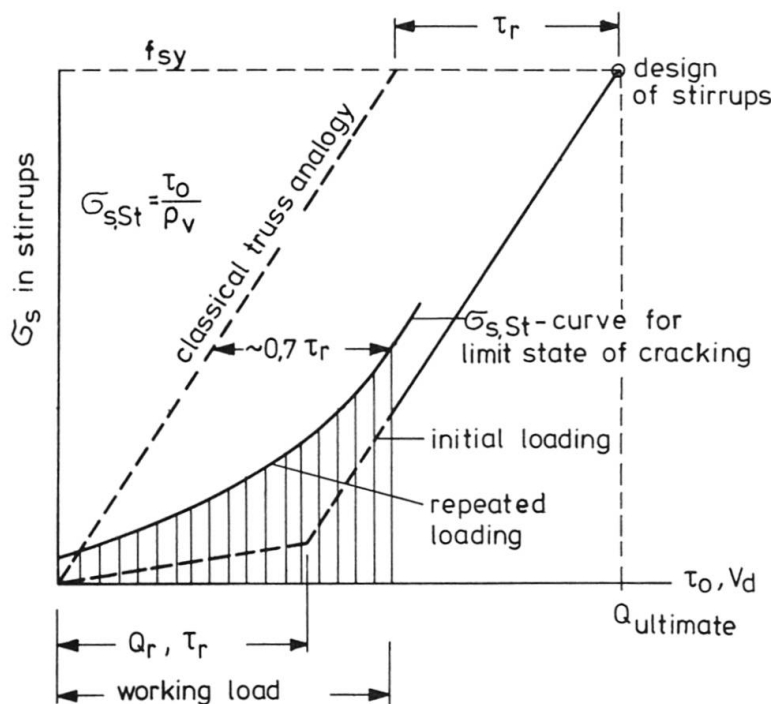

Fig. 14 Steel stresses in stirrups due to shear



Evaluation of measured widths of shear cracks teach that the min ρ_v for carrying capacity, which is about 0.14 % for S 400, is not sufficient for crack width limitation. Recommendations for min ρ_v with regard to shear crack control are given in chapter 11, J.

If we have high shear stresses and wish to get invisible crack width, then inclined stirrups give a good result with less than half of the min ρ_v -values needed for vertical stirrups, mainly because $k_\alpha = 1$ and $k_4 = 1,4$ due to rectangular crossing of bars versus cracks.

9. TORSION CRACKS

Cracks due to torsion reach easily unadmissable widths, if the usual $0^\circ - 90^\circ$ reinforcing net is used (fig. 15). The cracks width is mainly controlled by the bar spacing. Rules for calculation are given in [1]. chapter 2.9.

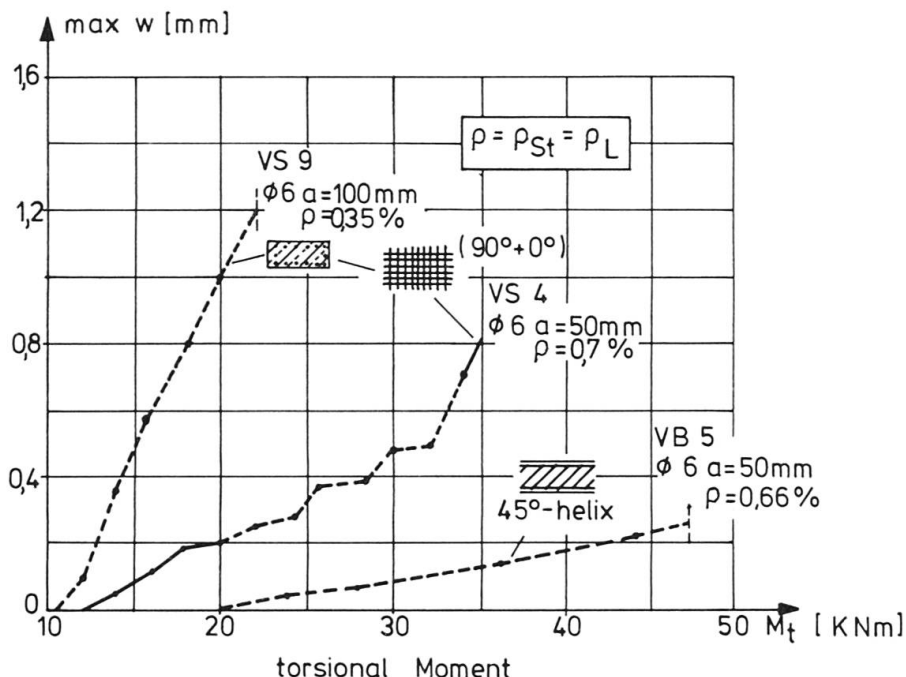

Fig. 15 Measured crack width in rectangular beams under pure torsion

If torsion is high and needed for equilibrium and if the torsional stress in concrete, calculated for state I becomes $\tau_t \geq 0.2 f_{ck}^{2/3}$, then the following small spacings of orthogonal bars or inclined transversal bars must be recommended:

Recommended spacing of bars for high torsion forces

crack width w_{95}	0,3	0,2	0,1	mm	spacing a
stirrups 90° and longitudinal bars 0°	120	80	50	mm	
inclined stirrups 45° rectangular to principle tension	250	200	100	mm	

10. CRACK WIDTH LIMITATION WITHOUT REINFORCEMENT

In massive structures which get more tensile stresses by temperature differences than by loads, it is rather useless to place reinforcing bars, because there will be almost no steel stresses if cracks develop. E. Bruy at Stuttgart University [2] proved theoretically and by tests that reinforcement has almost no influence on crack width if the cracks do not penetrate deeper than about $0.2 h$ or $0.6 m$. Limiting of the crack depth to such an amount can easily be secured by small compressive forces in the interior as they are caused with temperature stresses or as they can be enforced with a small amount of prestressing with average compression as low as 0.3 to 0.6 N/mm^2 . Under this condition, the crack width can be computed from the relieved tensile strain which has a maximum of $\epsilon_{tu} = 0.012 \%$ (fig. 16).

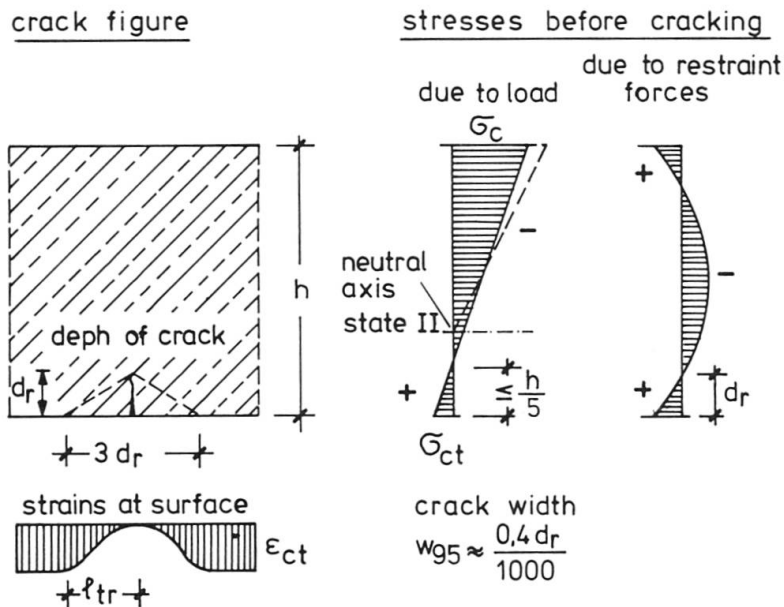

Fig. 16 Conditions for stress diagrams to limit crack width without reinforcement

The crack width for a crack depth of d_r and a transfer length $l_{tr} = 1.5 d_r$ will be:

$$w_m = 2 l_{tr} \frac{2}{3} \epsilon_{tu} = 2 d_r \cdot \epsilon_{tu}$$

with $k_4 = 1.6$ for scatter and $\epsilon_{tu} = 0.012 \%$, we get $w_{95} = 4 \cdot 10^{-4} \cdot d_r$.

This means that a crack 250 mm deep will have a maximum width of only 0.1 mm, if $d_r < 0.2 h$.

This verification of crack width can also be used for structures being "partially" prestressed, but the tendons should be assumed to have no bond and possible actions due to restraint (especially additional bending moments due to ΔT or different settlement of bearings etc.) must be considered.



11. CONCLUSIONS FOR PRACTICAL DESIGN

- A) Limitation of crack width belongs to limit state design for serviceability and therefore has to be done for service load without increasing safety factors. In most cases it is sufficient to fulfil limit requirements for permanent load or for permanent load + frequent live load, which is only a part of full live load, i. e.
- $$G + \psi Q \quad \text{with} \quad \psi = 0.2 \text{ to } 0.7$$

The calculations should be done with mean values of strength and strains and the results should be multiplied with factors regarding scatter up to 95 % fractiles. Often it may be sufficient to limit the average crack width w_m depending on use of structure and visibility of cracks. Restraint forces must be kept in mind, but usually should not be calculated. Charts for reading the design values directly should be preferred to complicated calculations.

- B) Reinforcing bars can enforce small crack width only in a small area around the bars, called area of efficacy $A_{c,ef}$ which has a maximum radius around the bar of only 4 to 6 bar ϕ . The ratio of reinforcement $\rho_{t,ef}$ must be related to this area of efficacy for crack limitation design.
- C) The crack width is primarily influenced by
- the bond quality of the rebars, deformed bars have to be preferred
 - the value of ϕ/ρ_t , the smaller the bar diameter, the less steel is needed,
 - the spacing of the bars. The required limit of crack width can practically be related to maximum admissible bar spacings, if the expected cracks cross the bars almost rectangularly.

lim $w_{95} =$	0.1	0.2	0.3 mm
max bar spaces a mm for $\sigma_s^{II} \rightarrow 240 \text{ MPa}$	100	150	200
for $\sigma_e^{II} < 120 \text{ MPa}$	150	200	300

- the jump of steel stress at cracking, which weakens the bond on a certain length and hereby can cause large initial crack widths.
- D) For low ratio percentages $\rho_t < 0.8 \%$ for tension
and $\rho_t < 0.3 \%$ for bending
high strength steel with a yield strength of about 400 N/mm^2 should be used.
- E) Grouted tendons should be neglected in the steel area for ρ_t , because their bond quality is too poor.
- F) For shear and torsional cracks, the amount of reinforcement sufficient for ultimate load design may not be sufficient for crack width limitation.
- G) In massive structures with low concrete stresses due to loads, reinforcement with bars is useless for crack control. The depth of cracks should be limited to $h/5 \cong 0.6 \text{ m}$ in such structures by a small amount of prestressing.

Applications of such prestressing of massive concrete structures are reported in [3].

H) No verification of crack width limits is needed, if the following ratios of reinforcement are used to satisfy ultimate load requirements, if the concrete quality is not higher than C 45

for <u>tension-members</u> Concrete strength < C 45 bar $\phi \leq 12$ mm bar $\phi \approx 20$ mm	$w_{95} =$	0,1	0,2	0,4 mm	
	$\rho_{t,ef} >$	1,4	1,0	0,7 %	
	$\rho_{t,ef} >$	1,7	1,2	0,9 %	
for <u>flexural tensile flange</u> with σ_s^{II} up to 120 MPa bar $\phi \leq 12$ mm bar $\phi \approx 20$ mm with σ_s^{II} up to 220 MPa bar $\phi \leq 12$ mm bar $\phi \approx 20$ mm	$\rho_{t,ef} >$	2,7	0,8	0,35 %	
	$\rho_{t,ef} >$	4,0	1,4	0,8 %	
	$\rho_{t,ef} >$	6,0	2,8	1,4 %	
	$\rho_{t,ef} >$	9,0	5,0	2,7 %	
	for <u>webs in flexural tensile zone</u> (longitudinal reinforcement, related to $(b_w \Delta h)$) with σ_s^{II} up to 80 MPa bar $\phi \leq 12$ mm with σ_s^{II} up to 160 MPa bar $\phi \leq 12$ mm	$\rho_{t,ef} >$	0,8	0,4	0,25 %
		$\rho_{t,ef} >$	3,6	1,0	0,45 %
for <u>webs in shear zone</u> vertical stirrups related to $b_w a_s$ with τ up to 2,0 MPa bar $\phi \leq 12$ mm with τ up to 3,0 MPa bar $\phi \leq 12$ mm or $\phi/h \leq 0,007$ for 45° inclined stirrups $\rho_S/2$ is sufficient	$\rho_S >$	1,4	0,8	0,55 %	
	$\rho_S >$	2,0	1,4	0,9 %	



J) Recommendations for minimum ratios of reinforcement to satisfy limit states of crack width: and/or ultimate load requirements:

concrete class f_{ck} [MPa]			10	20	30	40	50		
f_{ct} [MPa]			1,0	1,5	1,9	2,2	2,5		
			min ρ in % and $\rho_{t,ef}$						
tension	failure	S 400	0,48	0,64	0,78	0,90	1,00		
		S 500	0,40	0,54	0,66	0,76	0,84		
	limit states of cracking at cracking force	with ϕ 8 St 400	w_{95}	0,1 mm	1,05	1,10	1,15	1,20	1,25
				0,4 mm	0,46	x	x	x	x
			w_m	0,1 mm	0,80	0,85	0,90	0,95	1,0
				0,4 mm	0,36	x	x	x	x
		with ϕ 16 St 400	w_{95}	0,1 mm	1,4	1,5	1,6	1,65	1,70
				0,4 mm	0,67	0,72	0,75	0,80	0,85
			w_m	0,1 mm	1,10	1,13	1,18	1,22	1,25
				0,4 mm	0,54	0,56	x	x	x
	bending	failure according to Stuttgarter tests with BSt 42/50	rectangular $\rho = \frac{A_{sl}}{bh}$	0,10	0,10	0,12	0,14	0,16	
			T-beam $\rho_t = \frac{A_{sl}}{b_w(h-x)}$	0,20	0,26	0,31	0,36	0,40	
limit states of cracking for $\sigma_s = 200$ MPa $\phi < 16$ mm $e < 10$ cm		$\rho_{t,ef}$ related to $A_{c,ef}$							
		w_{95}	0,1 mm	3,0	3,2	3,4	3,6	3,8	
			0,4 mm	0,96	1,04	1,10	1,18	1,24	
		w_m	0,1 mm	1,90	2,00	2,10	2,20	2,30	
0,4 mm	0,62		0,65	0,68	0,72	0,77			
bending with compression	limit states of cracking depend on relative depth of neutral axis at relevant load or at cracking load. Reduction factor $(h-x)/h$ A smaller percentage of reinforcement is sufficient here compared to pure bending								

x = ρ failure relevant

Notations following CEB-rules

σ_s	=	stress in steel bars
$\sigma_{s, st}$	=	stress in stirrups
σ_c	=	stress in concrete
$\sigma_{s, r}$	=	stress in steel at cracking of concrete
σ^I	=	stress in uncracked state I } by linear analysis
σ^{II}	=	
f_{ct}	=	tensile strength of concrete
n	=	$\frac{E_s}{E_c}$
τ_b	=	bond stress at rebars
f_b	=	bond strength, peak value
$\tau_{b, av}$	=	average bond stress over transfer length
\emptyset	=	diameter of rebars
l_{tr}	=	transfer length of bond at cracks
l_o	=	length of almost lost bond of cracks
s	=	crack spacing
w	=	crack width
u	=	circumference of rebars
a	=	distance or spacing of rebars
c	=	concrete cover of rebars
ϵ	=	strain
A_c	=	cross-sectional area of concrete member
A_s	=	area of steel bars
A_{ct}	=	concrete area under tension
$A_{c, ef}$	=	concrete area, over which steel reinforcement can affect width and spacing of cracks = area of efficacy
d_{ef}	=	depth of area of efficacy
ρ	=	geometrical ratio of reinforcing steel = $\frac{A_s}{A_c}$ (usually given in percent %)
ρ_t	=	ρ referred to A_{ct} = concrete area under tension
$\rho_{t, ef}$	=	ρ referred to area of efficacy $A_{c, ef}$
ρ_v	=	ratio of shear reinforcement related to web width
τ_o	=	nominal shear stress $\frac{V}{b_w z}$
τ_r	=	shear stress due to shear force V_r causing shear crack
z	=	internal lever arm
b_w	=	web thickness



References

- [1] Leonhardt, F.: Vorlesungen über Massivbau. Vierter Teil: Nachweis der Gebrauchsfähigkeit; Rissebeschränkung, Formänderungen, Momentenumlagerung und Bruchlinientheorie im Stahlbetonbau. Berlin, Springer-Verlag, 1976
- [2] Bruy, E.: Über den Abbau instationärer Temperaturspannungen in Betonkörpern durch Rißbildung. Dissertation Universität Stuttgart 1972
- [3] Leonhardt, F.: Massige, große Betontragwerke ohne schlaaffe Bewehrung, gesichert durch mäßige Vorspannung. Beton- und Stahlbetonbau 68 (1973), Heft 5, pp. 128-133
- [4] Avram, C.; Mihaescu, A.: Espacement et ouverture des fissures des éléments prismatiques en béton armé soumis à la compression excentrée. Estratto da Costruzioni in cemento armato - Studi e Rendiconti - Volume 7, 1970
- [5] Falkner, H.: Zur Frage der Rißbildung durch Eigen- und Zwängspannungen infolge Temperatur in Stahlbetonbauteilen. DAfStb., H. 208, Berlin, W. Ernst u. Sohn, 1969
- [6] Rostásy, F.S.; Koch, R.; Leonhardt, F.: Zur Mindestbewehrung von Zwang von Außenwänden aus Stahlleichtbeton. DAfStb., H. 267, Berlin, W. Ernst u. Sohn, 1976
- [7] Goto, Y.: Cracks formed in concrete around deformed tension bars. Journal ACI, Proc. Vol. 68 (1971), No. 4, p. 244 - 251
- [8] Beeby, A.W.: An Investigation of Cracking in Slabs Spanning one Way. TRA 433, April 1974, Cement and Concrete Association.