

Objektyp: **Advertising**

Zeitschrift: **IABSE structures = Constructions AIPC = IVBH Bauwerke**

Band (Jahr): **9 (1985)**

Heft C-34: **Telecommunication towers**

PDF erstellt am: **22.09.2024**

### **Nutzungsbedingungen**

Die ETH-Bibliothek ist Anbieterin der digitalisierten Zeitschriften. Sie besitzt keine Urheberrechte an den Inhalten der Zeitschriften. Die Rechte liegen in der Regel bei den Herausgebern.

Die auf der Plattform e-periodica veröffentlichten Dokumente stehen für nicht-kommerzielle Zwecke in Lehre und Forschung sowie für die private Nutzung frei zur Verfügung. Einzelne Dateien oder Ausdrucke aus diesem Angebot können zusammen mit diesen Nutzungsbedingungen und den korrekten Herkunftsbezeichnungen weitergegeben werden.

Das Veröffentlichen von Bildern in Print- und Online-Publikationen ist nur mit vorheriger Genehmigung der Rechteinhaber erlaubt. Die systematische Speicherung von Teilen des elektronischen Angebots auf anderen Servern bedarf ebenfalls des schriftlichen Einverständnisses der Rechteinhaber.

### **Haftungsausschluss**

Alle Angaben erfolgen ohne Gewähr für Vollständigkeit oder Richtigkeit. Es wird keine Haftung übernommen für Schäden durch die Verwendung von Informationen aus diesem Online-Angebot oder durch das Fehlen von Informationen. Dies gilt auch für Inhalte Dritter, die über dieses Angebot zugänglich sind.

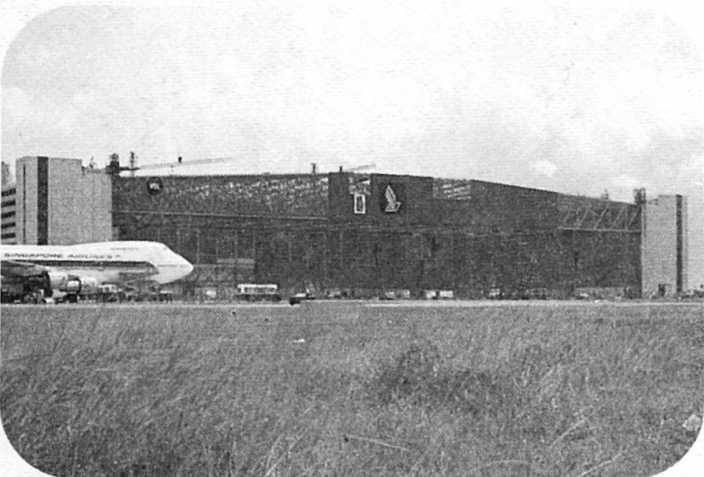
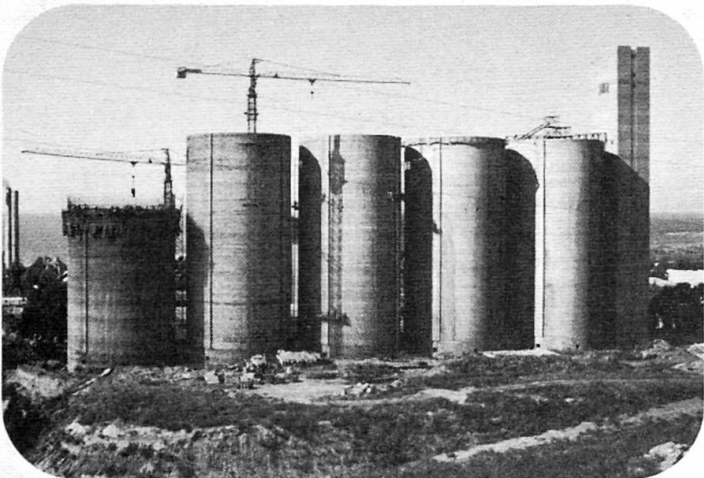
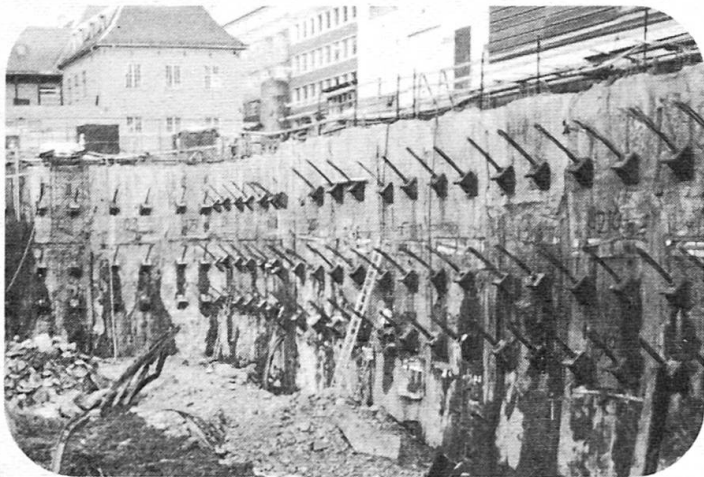
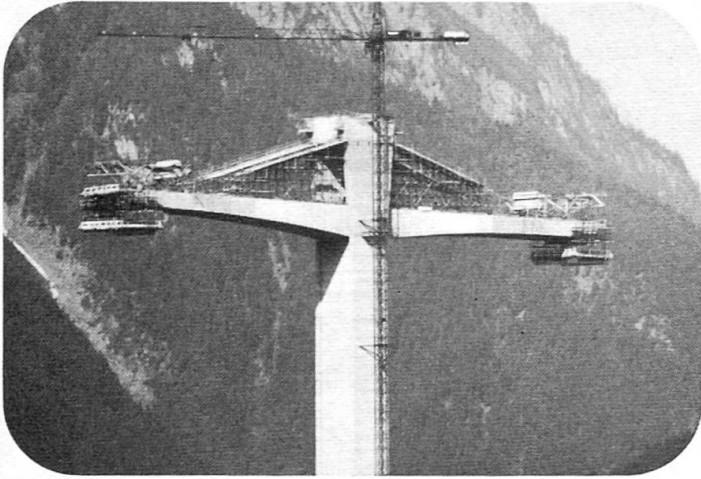

**the symbol for:**

- **Post-tensioning**
- **Soil and Rock Anchors**
- **Slipforming**
- **Heavy Rigging**

Please send me detailed information on:

- Post-tensioning \_\_\_\_\_
- Soil and Rock Anchors \_\_\_\_\_
- Slipforming \_\_\_\_\_
- Heavy Rigging \_\_\_\_\_
- Other \_\_\_\_\_

send this coupon to the address below or to the next VSL Representative

**VSL INTERNATIONAL LTD**  
Könizstrasse 74  
3001 Berne/Switzerland  
Phone 031 46 28 33  
Telex 911755

Representatives in:  
Australia, Austria, Belgium, Brazil, Canada, Denmark, Finland, France, FR Germany, Greece, Honduras, Hong Kong, Indonesia, Iran, Ireland, Italy, Japan, Korea, Kuwait, Malaysia, Netherlands, Norway, Panama, Peru, Philippines, Portugal, Saudi Arabia, Singapore, South Africa, Sweden, Switzerland, Taiwan, Turkey, United Kingdom, USA, Venezuela.

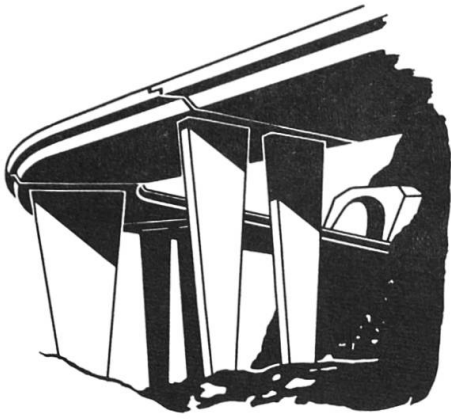

**Belags-Sickerwasser-  
Ableiter**  
*Subsurface Seepage.*  
**Evacuations des eaux  
et aérations.**  
*Ductos de agua de  
filtración para calzadas.*

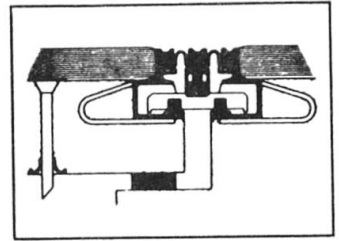

**Fahrbahn-Übergangs-  
Konstruktionen.**  
*Expansion joints.*  
**Raccordements de  
chausées**  
*Sistemas de juntas  
de dilatación.*

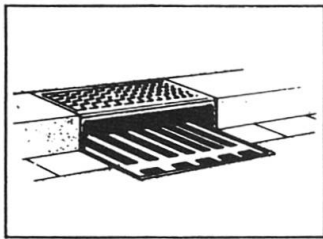

**Entwässerungs-Systeme**  
*Surface drainage*  
**Evacuations des eaux**  
*Pozos de drenaje*

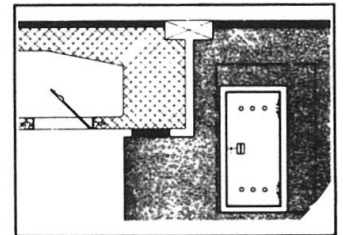
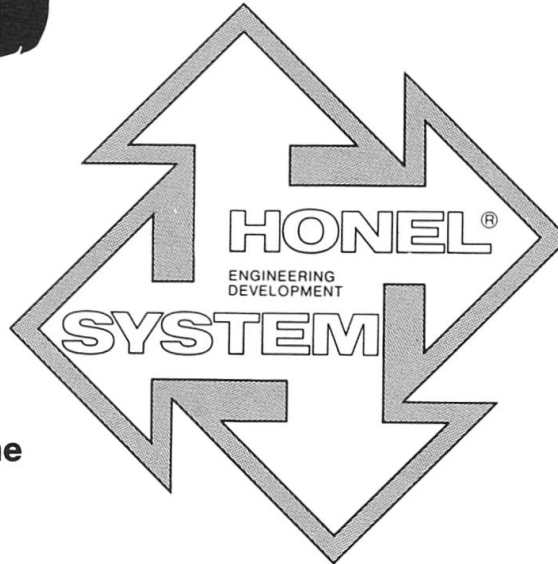

**Hohlraumschalungen  
Einstiegluken + Türen**  
*Formwork + Moulds*  
*Access openings*  
**Ouvertures d'entrée**  
*Aberturas de entrada*

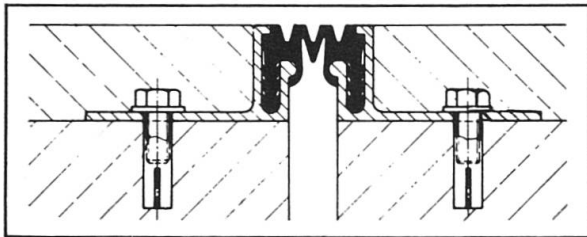

**Fugendichtungen im Hoch- + Tiefbau**  
*Joint seals + Joint profilés*  
**Sellos para juntas**

**Auflager**  
*Structural*  
*Bearings*  
**Appuis**  
*Apoyos*

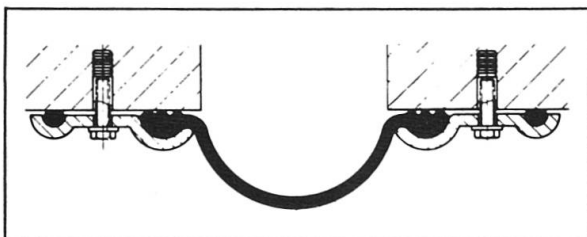
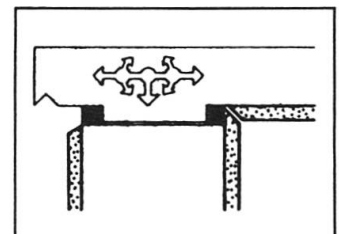

**Pressen + Pumpen**  
*Hydraulic jacks*  
**Verins + Pompes**  
*Prensas + bombas*



**heinz honegger ag**

CH-8427 Rorbas ZH Switzerland  
Tel. 01 - 865 11 77, Telex 52844

**Vertretungs- und Lizenzvergabe:**

Honel-Holding SA  
Sonnmattstrasse 6  
CH-8180 Bülach, Switzerland  
Phone 01/860 89 43





## Wild DI1000 DISTOMAT™

The EDM you can afford for every crew

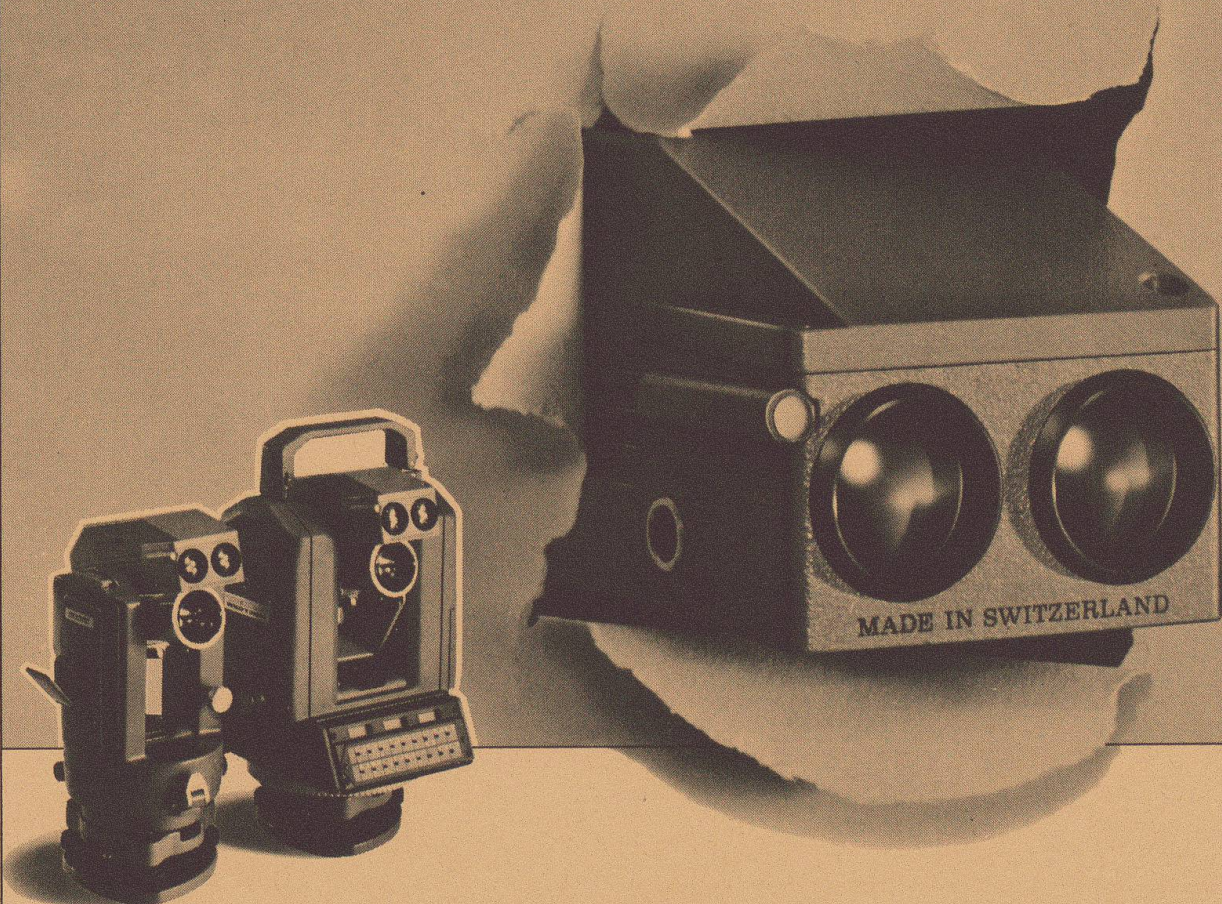

# a b r e a k t h r o u g h

**in size**

In day-to-day work, 99% of distance measurements are less than 500 m. The need is for a small, lightweight, easy-to-use EDM that measures quickly and accurately.

**weight**

This is the DI1000, the instrument that makes a tape redundant:

- 500 m to a single prism
- 800 m to three prisms (1000 m in favourable conditions)
- 5 mm +5 ppm accuracy
- Slope, horizontal distance, height difference
- Setting-out mode
- Fits on all Wild theodolites, optical and electronic

**performance**

The ideal instrument for:

- Building and construction
- Civil engineering and setting out
- Drainage and irrigation
- Cadastral, detail and topographic surveys
- Mining and tunnelling

Ask for a brochure, demonstration and offer. ■

**price**

G 76-85



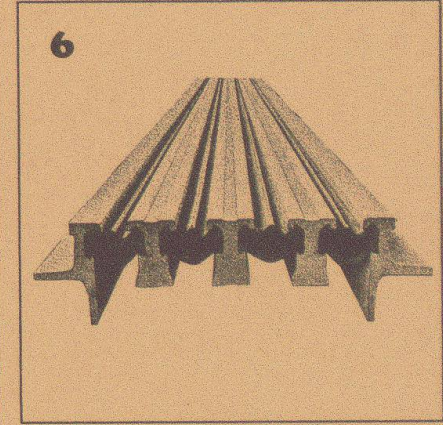
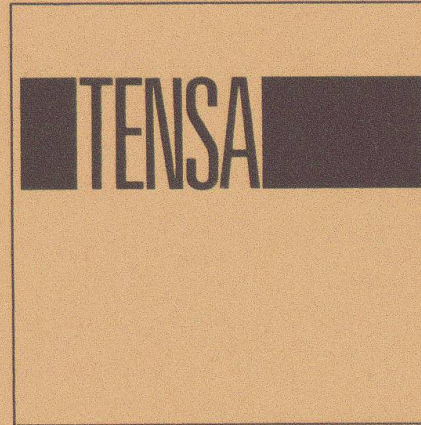
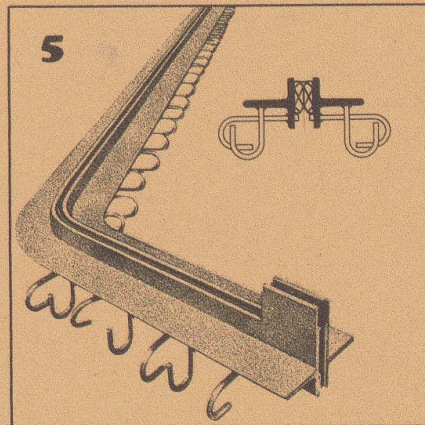
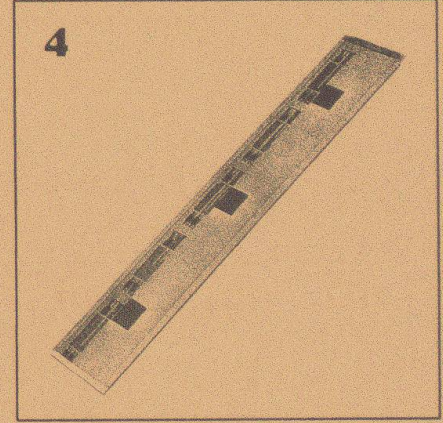
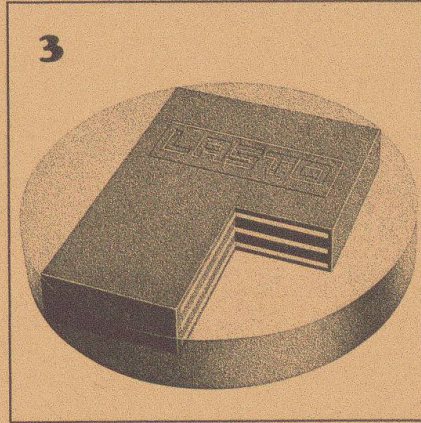
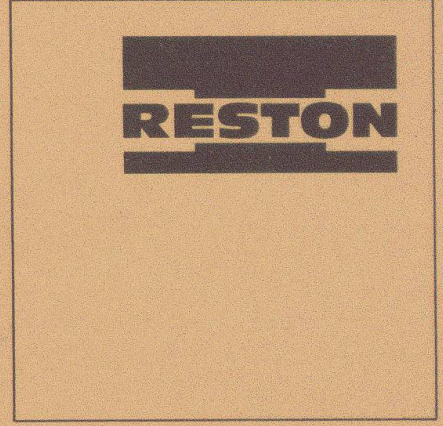
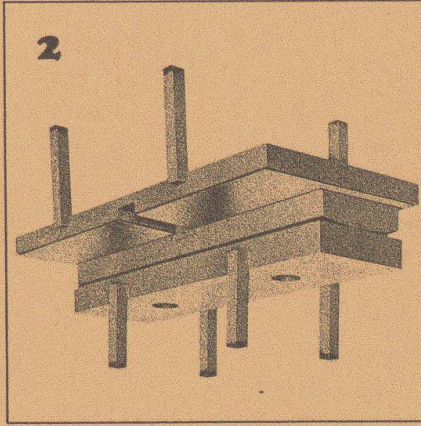
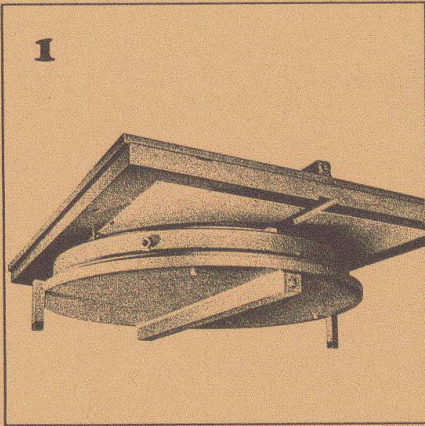

**1**  
**RESTON Pot Sliding Bearings** are highly suitable for installation in bridge structures. They feature a low-profile design, low weight and high loading capacity.

**2**  
**RESTON Linear Tilting and Sliding Bearings** are a combination of normal linear tilting bearings and PTFE sliding bearings and are suitable for installation in bridge structures.

**3**  
**LASTO-BLOCK Bearings** are suitable for building, civil engineering and bridge construction applications. Their simple form allows easy installation.

**4**  
**LASTO-STRIP Bearings for Buildings** were especially developed for building constructions. They are particularly suitable for movement compensation between concrete slabs and load-supporting walls and prevent structural cracking.

**5**  
**TENSA-ACME Roadway Construction Joints** are highly suitable for installation in traffic levels (parking lots, bridges, airport areas etc.). Dilatation up to 60 mm.

**6**  
**TENSA-LASTIC Roadway Construction Joints** meet all the requirements that can be made in bridge engineering of a modern joint design. They are rugged and watertight. Dilatation range 60 mm and bigger.

PROCEQ SA  
 Riesbachstrasse 57  
 CH-8034 Zurich

proceq

Phone: 01/47 7800  
 Telex 53357 proce ch