

Grandstand at Goodwood Racecourse (England)

Autor(en): **Bobrowski, J.**

Objektyp: **Article**

Zeitschrift: **IABSE structures = Constructions AIPC = IVBH Bauwerke**

Band (Jahr): **4 (1980)**

Heft C-13: **Sports halls and stadia**

PDF erstellt am: **21.09.2024**

Persistenter Link: <https://doi.org/10.5169/seals-16535>

Nutzungsbedingungen

Die ETH-Bibliothek ist Anbieterin der digitalisierten Zeitschriften. Sie besitzt keine Urheberrechte an den Inhalten der Zeitschriften. Die Rechte liegen in der Regel bei den Herausgebern. Die auf der Plattform e-periodica veröffentlichten Dokumente stehen für nicht-kommerzielle Zwecke in Lehre und Forschung sowie für die private Nutzung frei zur Verfügung. Einzelne Dateien oder Ausdrucke aus diesem Angebot können zusammen mit diesen Nutzungsbedingungen und den korrekten Herkunftsbezeichnungen weitergegeben werden. Das Veröffentlichen von Bildern in Print- und Online-Publikationen ist nur mit vorheriger Genehmigung der Rechteinhaber erlaubt. Die systematische Speicherung von Teilen des elektronischen Angebots auf anderen Servern bedarf ebenfalls des schriftlichen Einverständnisses der Rechteinhaber.

Haftungsausschluss

Alle Angaben erfolgen ohne Gewähr für Vollständigkeit oder Richtigkeit. Es wird keine Haftung übernommen für Schäden durch die Verwendung von Informationen aus diesem Online-Angebot oder durch das Fehlen von Informationen. Dies gilt auch für Inhalte Dritter, die über dieses Angebot zugänglich sind.

3. Grandstand at Goodwood Racecourse (England)

Owner: Goodwood Racecourse Ltd

Architect: Howard Lobb Partnership

Consultant Architect: Philip Dowson, CBE

Engineer: Jan Bobrowski and Partners

Contractor: James Longley & Co Ltd

Structural Sub-Contractors:

Worman-Lyncrete Ltd – Erection Anglian Building

Products Ltd – Precasting BBRV Simonbuild Ltd –

Suspension Cables and Postensioning

Dimensions and arrangement:

Total surface: 8,900 m²

Number of floors: 4

Space built: 41,500 m³

Column spacing: 15 m × 14.4 m

Live load excluding permanent load: 5 kN/m²

Other facilities:

31 private boxes with common food preparation facility, 3 bars and space for future restaurant, covered Tote facilities with public circulation areas, toilets, etc.

Works duration: 10 months

Service date: July 1980

“Glorious Goodwood” – the very name conjures up all that is best in English racing. Race meetings were started at Goodwood by the 3rd Duke of Richmond in the Spring of 1801, and the racecourse still remains part of the present Duke of Richmond’s estate. However, the historic old grandstand has reached the end of its useful life and has been replaced by a new grandstand of outstanding architectural merit.

To demolish the old building and complete a new cable-stayed structure (Figs. 1a, 1b, 1c) in 10 months called for a fast and simple erection system with most components built under factory conditions to beat the winter (see Fig. 2). Apart from safety, comfort and retention of the “garden party spirit” the new grandstand is also expected to meet stringent requirements with respect to economy and durability.

Heavy masonry structures are no longer economical and painting, patching and other types of maintenance required with steel or timber structures, which were taken for granted in the past, are now expensive and difficult to arrange.

The basic structure consists of prefabricated H-frames and pretensioned double tee flooring, a combination which provided a very rapid form of erection.

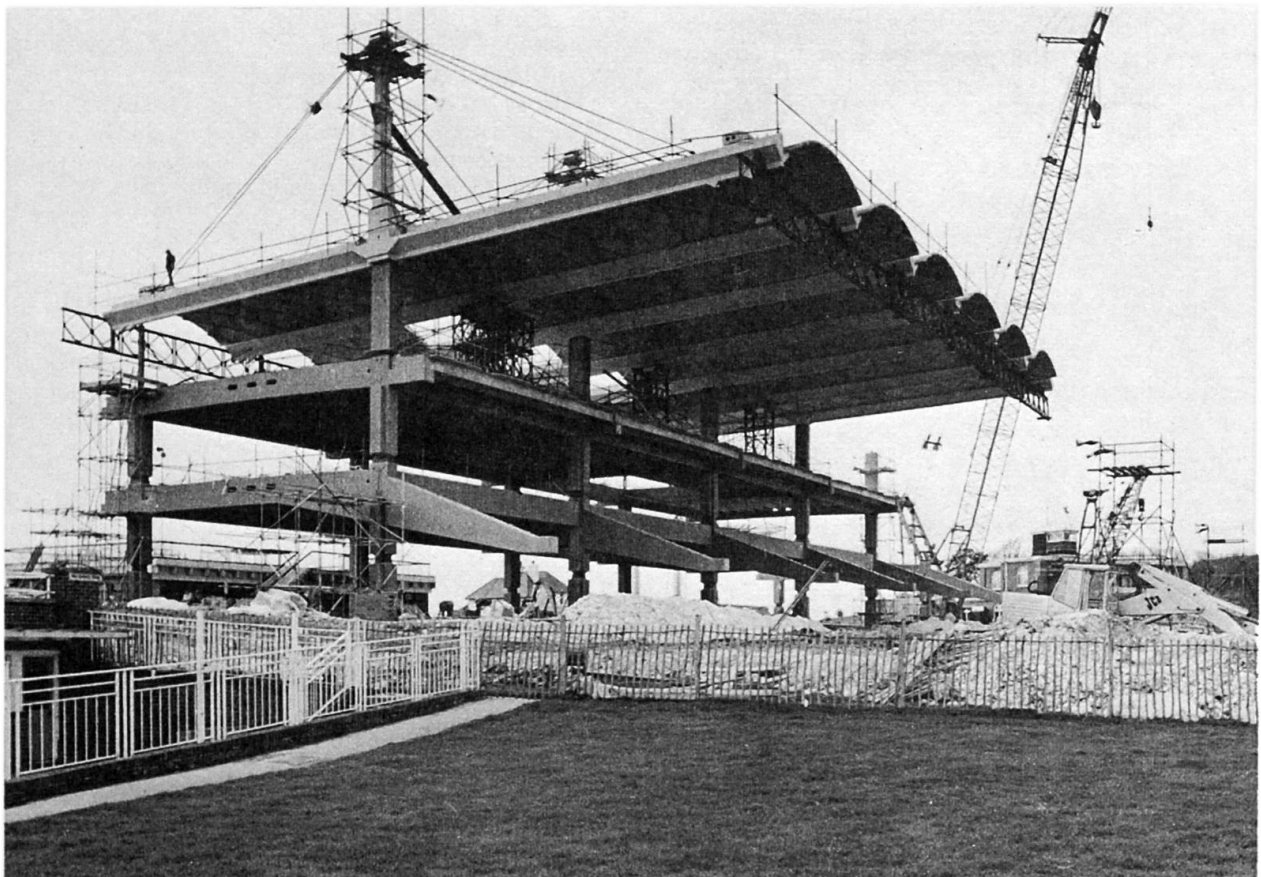

Goodwood Grandstand

Special restraints were imposed on the design by the Fine Arts Commission and the Client, requiring that the building should blend with the surrounding countryside and be of slender appearance and maintenance free. To satisfy these criteria it was decided to cable-stay the roof rather than to go for a more traditional cantilever over the front of the grandstand. Austenitic stainless steel cables, designed to be exchangeable if necessary, reduced the size of the 11 inverted roof beams to 1,200 mm depth for 35 m length.

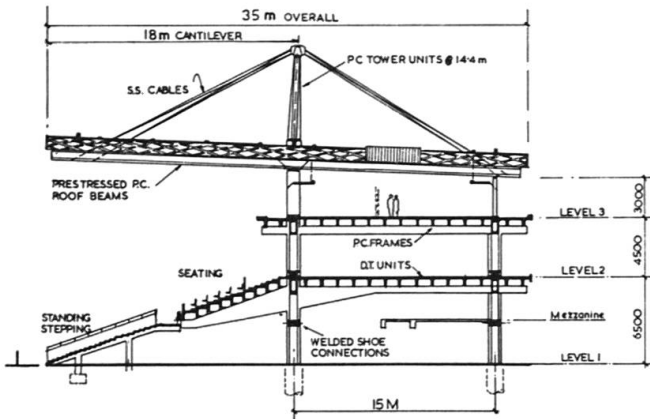

Fig. 1(a) Typical Cross Section

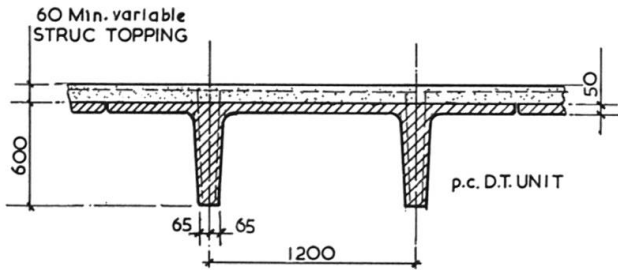

Fig. 1(b) Typical Section Thro D.T. Units

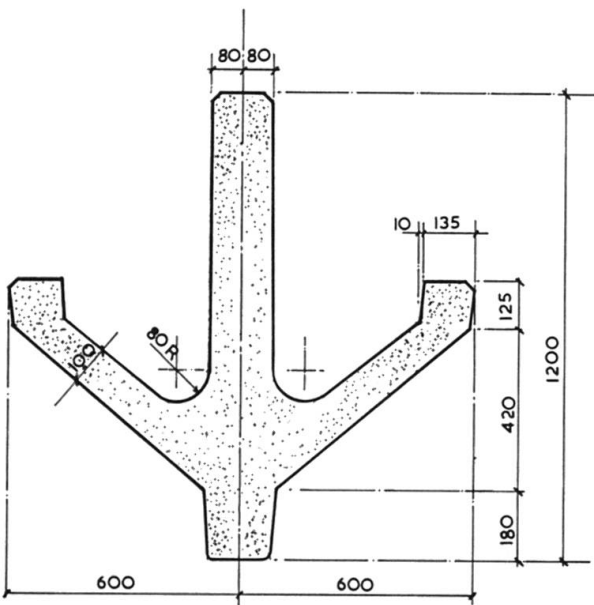

Fig. 1(c) Typical Section Through Pretensioned Roof Unit

Temporary supports were cut to an absolute minimum and match-casting of basic elements ensured perfect fit on site. From each of the 6 pylons above the roof 2 tendons run to the ends of the 6 main beams. A further 6 radiating tendons suspend the intermediate beams. Each tendon comprises 19 austenitic stainless steel-wires of 6 mm diameter. Lightweight concrete shells, 60 mm thick (Fig. 3) span between the main beams.

Such light cantilever constructions are susceptible to wind excitations, particularly due to vortex shedding. Consequently the design provided for the natural frequency of the structure, to differ sufficiently from the frequency of wind loading to avoid resonance. The magnitude of vibration is controlled by the provision of external friction damping at the top of the pylons. Like the cables themselves so the dampers are designed to be exchangeable.

The main body of the structure was erected in about 4 weeks notwithstanding the fact that high winds and exceedingly bad weather lost the contractors about 9 days of this time. The erection sequence of the structure was considered at the design stage and with some components reaching 55 tons in weight it necessitated the use of 350 ton free-on-tracks Grays-ton's Manitowoc crane.

(J. Bobrowski)

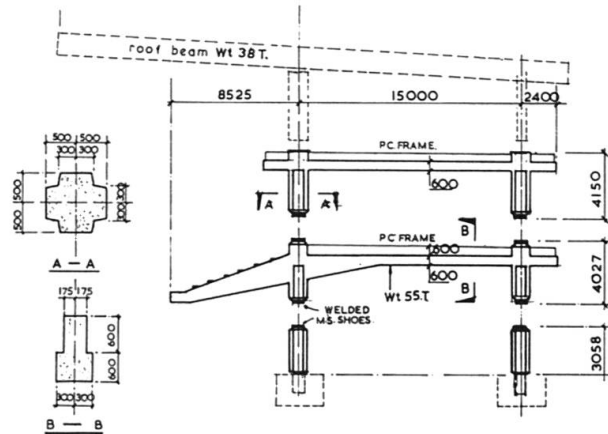

Fig. 2 Elements of Assembly

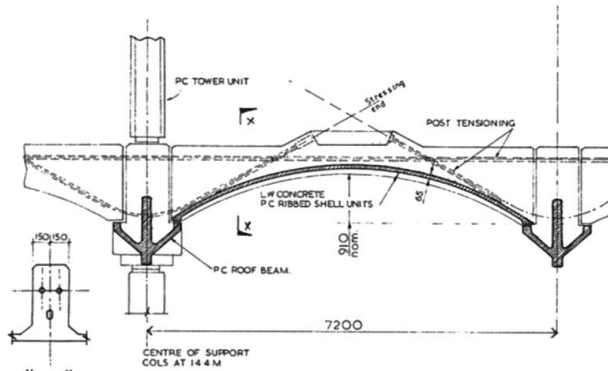

Fig. 3