

Incremental collapse of ordinary reinforced concrete beams

Autor(en): **Højlund, Rasmussen**

Objektyp: **Article**

Zeitschrift: **IABSE publications = Mémoires AIPC = IVBH Abhandlungen**

Band (Jahr): **16 (1956)**

PDF erstellt am: **23.09.2024**

Persistenter Link: <https://doi.org/10.5169/seals-15076>

Nutzungsbedingungen

Die ETH-Bibliothek ist Anbieterin der digitalisierten Zeitschriften. Sie besitzt keine Urheberrechte an den Inhalten der Zeitschriften. Die Rechte liegen in der Regel bei den Herausgebern.

Die auf der Plattform e-periodica veröffentlichten Dokumente stehen für nicht-kommerzielle Zwecke in Lehre und Forschung sowie für die private Nutzung frei zur Verfügung. Einzelne Dateien oder Ausdrucke aus diesem Angebot können zusammen mit diesen Nutzungsbedingungen und den korrekten Herkunftsbezeichnungen weitergegeben werden.

Das Veröffentlichen von Bildern in Print- und Online-Publikationen ist nur mit vorheriger Genehmigung der Rechteinhaber erlaubt. Die systematische Speicherung von Teilen des elektronischen Angebots auf anderen Servern bedarf ebenfalls des schriftlichen Einverständnisses der Rechteinhaber.

Haftungsausschluss

Alle Angaben erfolgen ohne Gewähr für Vollständigkeit oder Richtigkeit. Es wird keine Haftung übernommen für Schäden durch die Verwendung von Informationen aus diesem Online-Angebot oder durch das Fehlen von Informationen. Dies gilt auch für Inhalte Dritter, die über dieses Angebot zugänglich sind.

Incremental Collapse of Ordinary Reinforced Concrete Beams

Rupture progressive des poutres en béton armé courant

Vergrößerung der Bruchgefahr von normalen bewehrten Eisenbetonbalken

B. HØJLUND RASMUSSEN, Kopenhagen

Tests on Incremental Collapse of Reinforced Concrete Beams

Introduction

The mounting interest in utilizing the plastic properties of steel in the dimensioning of bearing structures has been demonstrated by a very great number of theoretical works, particularly in the last decade.

The basic assumption for these theoretical works is in general that the relation between alterations in the bending moment of a beam and the corresponding alterations in the curvature can be approximated by two straight lines, viz:

$$\begin{aligned} \Delta \frac{d^2 w}{dx^2} &= -\frac{\Delta M}{B} && \text{for } M < M_u \\ \Delta \frac{d^2 w}{dx^2} &\text{ indeterminate } && \text{for } M = M_u. \end{aligned} \tag{1}$$

Notations: w = the deflexion of the beam.

M = the moment of the section considered.

M_u = the moment causing yield in the entire cross section.

B = the flexural rigidity of the beam.

For a structure, the elements of which follow eqs. (1), there is, as will be known, a theoretical possibility that certain load combinations applied to the structure a sufficient number of times can produce deflexions of unlimited magnitude, even if the structure is at no time submitted to a load which, applied once, is able to produce deflexions of unlimited magnitude. Failure of the structure may occur as a result of incremental collapse.

While a great number of authors have dealt with the subject theoretically,

both on the assumption of the validity of the simple eqs. (1) and on more general assumptions paying regard to the smooth transition between the two straight lines (1) and to the influences of strain-hardening and Bauschinger effect, the tests made up till now have been rather few. The author is acquainted with three test series on continuous beams of steel.

The tests were made by K. KLÖPPEL [1], by Laboratoires de l'Institut Technique du Bâtiment et des Travaux Public in Paris on the initiative of J. DUTHEIL [2], [3], and by CH. MASSONNET [4].

The test beams were in all cases continuous over two equal spans and loaded with a concentrated force P in each span. In the tests made by KLÖPPEL, and in part also in those made by DUTHEIL, the load at which the test beams did shake down was greater than the theoretical, but in his very detailed report on a fairly great number of tests Massonnet has demonstrated possible causes of this, and he himself found very good agreement between tests and theory, after he gets around the deviation between (1) and the actual relation between ΔM and $\Delta \frac{d^2w}{dx^2}$ in the following manner:

That value of one of the two forces P which can produce a certain yield both at the loaded point and over the intermediate support, is called P_u . On account of strain-hardening and the difference between M_u and the moment at which the yield in the cross-section is introduced, P_u is not eo ipso defined, but is defined by MASSONNET in that the residual value, f_u^{res} , of the deflexion under P_u must be equally great as the elastic one, f_u^{el} . If one of the forces P , or possibly both forces, vary between a certain minimum value and a certain maximum value P_{max} , the tests show that the beam shakes down after ten to twenty load cycles, if P_{max} does not exceed $1.1 P_u$. Now MASSONNET defines that load P_s , at which the beam shakes down at repeated loads, by the condition $f_s^{res} = f_u^{res}$, where f_s^{res} is the residual deflexion under P_s when the beam has shaken down, and thus he finds, as mentioned above, good agreement for rolled steel beams between tests and theory in the determination of P_s .

In the case of reinforced concrete beams there are, as far as the author knows, no corresponding tests available, and since the utilization of the plastic properties of the steel reinforcement in the dimensioning of reinforced concrete structures in Denmark play a very great part in practice*), the Research Laboratory of Building Technique of the Technical University of Denmark undertook a series of tests to elucidate these problems.

*) The Danish standard specifications for reinforced concrete structures already in 1913 permitted slabs and beams to be calculated as so-called "partly clamped" (over each span apart). For the two bending moments M_1 and M_2 at the supports a value is introduced estimated to suit the degree of fixing, and accordingly the moment at the middle of the span is put as equal to the moment that would occur in a simply supported beam, with an allowance of not more than $\frac{1}{4} (M_1 + M_2)$. From 1921 the maximum allowance is $\frac{1}{3} (M_1 + M_2)$.

Description of Tests

The test beams

With one-week intervals, four beams were cast, 15 cm in height and 20 cm in width, reinforced with 2 \varnothing 14 mm at the top and bottom and bound with stirrups \varnothing 5 mm per 30 cm.

Beam B I was 225 cm in length, while beams B II, B III and B IV were 480 cm in length.

For all four beams the concrete batch was mixed as follows: Per cub. m.:

Standard Portland cement	252 kg
Water	197 kg
Gravel: FM = 1.85	790 kg
Aggregate 1: FM = 5.65	425 kg
Aggregate 2: FM = 6.30	650 kg

corresponding to an attempted compressive strength of cylinder (15 cm \times 30 cm) of 190 kg/cm².

Max. size of aggregates was 16 mm.

The slump of the concrete varied between 9 and 17 cm.

The concrete was tamped manually, and together with each beam six test cylinders were cast.

Both the beams and the cylinders were cured for 10 days under moist sacks, and for 18 days in laboratory atmosphere (40% relative humidity).

The testing of both beams and cylinders was made 28 days after the casting.

With two out of the six test cylinders for each beam, a determination was made simultaneously of the stress-strain line.

The results of the tests with cylinders are shown by table 1 below:

Table 1

Beam No.	I	II	III	IV
σ_P kg/cm ² of six 15 \times 30 cm prisms	176	203	229	195
	170	192	210	194
	183	200	234	207
	181	192	211	199
	176	197	212	178
	188	194	223	205
Mean	179	196	223	197
E_0 kg/cm ²	2.8×10^5	2.7×10^5	3.1×10^5	2.7×10^5
	2.3×10^5	2.3×10^5	3.1×10^5	2.8×10^5

As further described below, B 1 was tested, simply supported, with a span of 225 cm, while the rest of the beams were tested continuous over two spans and were loaded with concentrated forces at the middle of the spans. In these beams yields occurred during the tests in three cross sections, designated 1, 2 and 3.

Stress-strain lines were determined for all steel bars, and the dimensions of the relevant cross sections were measured after the tests. The data obtained are listed in table 2 below:

Table 2

Beam	Cross Section	b cm	h_n cm	P_y kg	ϵ_{max} %
B I		20.1	13.0	4000 – 4250	3.5
				3950 – 4100	2.6
B II	1	20.5	12.8	4630 – 4720	2.4
				4550 – 4130	2.3
	2	20.3	13.0	4550 – 4700	3.6
				4550 – 4630	3.4
	3	20.5	13.1	4630 – 4720	2.4
				4550 – 4630	2.3
B III	1	20.6	13.1	4620 – 4750	3.8
				4500 – 4620	3.4
	2	20.4	13.0	4550 – 4700	3.6
				4540 – 4610	2.7
	3	20.4	13.5	4620 – 4750	3.8
				4500 – 4620	3.4
B IV	1	20.5	13.1	4020 – 4200	3.1
				4050 – 4100	2.9
	2	20.5	12.9	4050 – 4180	3.6
				4000 – 4120	3.4
	3	20.5	13.1	4020 – 4200	3.1
				4050 – 4100	2.9

b denotes the width of the beam, and h_n the distance from the centroid of the tension reinforcement to the compression edge.

In the column for P_y are listed the upper and lower limits for the normal force in the steel bars during the yield.

ϵ_{max} denote the strain at the instant when the force begins to increase owing to strain-hardening.

During the yield the deformation velocity was $\frac{d\epsilon}{dt} \sim 0.25\%$ per minute.

Tests with B 1

B 1 was tested, simply supported, with a span of 225 cm loaded with a concentrated force at the middle in order, if possible, to enable prediction of the correlation between alterations of moment and alterations of curvature in the test beams proper, and specifically for the purpose of studying conditions in the plastic hinge which would develop at the middle of the beam.

The concentrated force and the reactions were transmitted to the beam through blocks of hard wood. The blocks were cylindrical, with generatrices perpendicular to the beam axis, and with a radius of curvature of about 100 cm.

A sketch of the test beam is shown in fig. 1. During the test the dial gages shown in the sketch were read at a number of points, 1—32, at the load deflexion line of the beam, and at the same points the strains of the reinforcement were read by means of strain gages marked *a—f* in fig. 1.

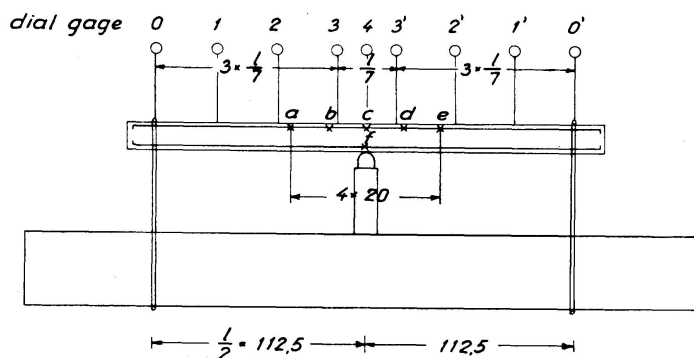

Fig. 1. B I. Sketch of test set-up; *a* to *f* indicate strain gages on the reinforcement.

The strain gages used, in the case of beam B 1, were P-A-3 gages glued on by means of 17-4-T-1 cement. These gages had the resistance $R = 119\Omega$ and the gage factor $k = 2.05$.

On beams B II, III and IV, Gustafsson A-620 S gages were glued on by means of thermo-setting L-cement. The resistance was here 118Ω and the gage factor $k = 2.14$. The gage length for both types was about 20 mm.

After the glue had hardened the gages were covered and the inlets to the employed P. V. C.-covered wires were covered with plastellina wax and then with a layer of "Araldit 102" glue.

The two above-mentioned strain gage types have been constructed for the purpose of measuring great strain.

Further, the total deflexion of the centre of the beam has been registered by means of the recorder of the testing machine, magnified four times.

Finally, the crack widths at certain points of the stress-strain line were determined.

From and inclusive of point 6 on the stress-strain line the readings took place as follows:

1. The deformations were altered to the value desired, and a set of readings made straight away.
2. The deformations were, as far as possible, kept constant for five minutes.
3. A complete set of readings was made again.

In fig. 2 is shown the deflexion of the centre of the beam measured with dial gage 4.

In fig. 3 is shown the deflexion of the same point registered by the recorder of the testing machine. It should be noted that no corrections have been made for settling of the supports, also that the configuration of the curve at reliefs of pressure is not correct.

The wire transmitting the movements from the beam to the recorder drum was about 6 m long, and this fact in connection with a certain friction in the recorder caused that the hysteresis loops seen in fig. 3 are much too wide.

However, it appears from fig. 3 that:

1. The yield moment keeps practically constant, while the deflexions grow from about 1 cm to well over 9 cm.
2. The configuration of the pressure-relief loops is practically alike at an early and at an advanced stage of the yield.

The yield moment M_u , when the deformations increased, was in the neighbourhood of 1160 kgm and dropped, after 5 minutes' waiting, to about 1050 kgm.

This last value must be presumed to hold for slow tests.

If M_u is divided by the sum of P_u (cf. table 2) for the two steel bars, one gets, both in B 1 and the other beams, a lever arm almost equal to h_n , while the actual lever arm must be smaller than h_n .

This is a generally known phenomenon which we do not propose to discuss here.

If the beam behaviour were completely elastic with a constant flexural rigidity B , the following equations would have been satisfied:

$$\Delta w_4 = \frac{\Delta M l^2}{12 B},$$

$$\Delta (2 w_1 - w_3) = \frac{\Delta M l^2}{8 B} \left(\frac{2}{7}\right)^3,$$

$$\Delta [2 w_2 - (w_1 + w_3)] = \frac{\Delta M l^2}{4 B} \left(\frac{2}{7}\right)^3.$$

If $l = 225$ cm as well as correlated values of deflexions and moments are inserted in these equations, we can find average values of the flexural rigidity of the beam.

Table 3, below, shows values of B determined in this manner, at different points of the stress-strain line.

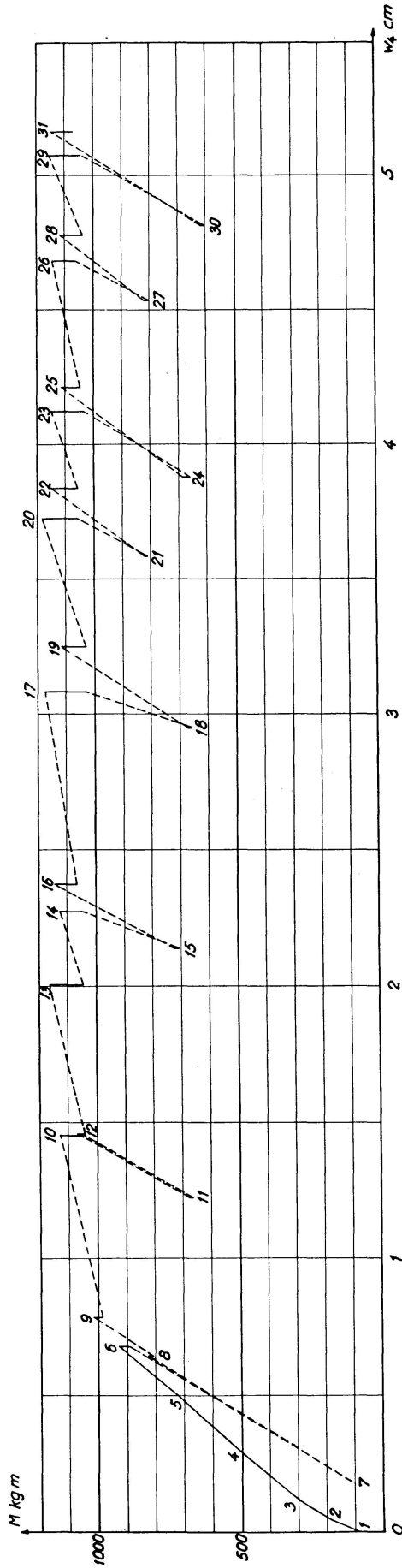

Fig. 2. B I. Deflexion of centre measured with dial gage 4. 1 to 31 indicate stations on the load deflexion curve.

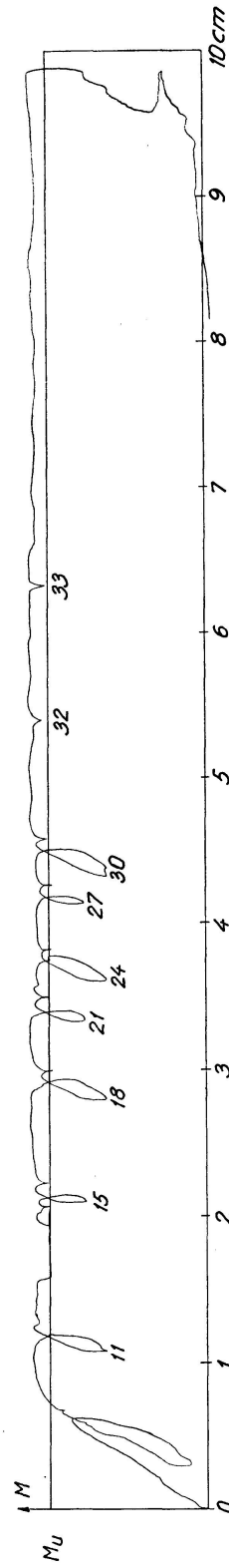

Fig. 3. B I. Deflexion of centre registered by the testing machine.

B_0 is determined by the first equation and gives an average value for the whole beam.

B_1 is determined by the second equation and gives an average value of B around points 1 and 1' (see fig. 1).

B_2 is determined by the last equation and gives an average value of B around points 2 and 2'.

The location on the stress-strain line is given in the first column of the table, so that e. g. 23—24 denotes that Δw and ΔM correspond to the alterations of the relevant magnitudes from point 23 to point 24 in fig. 2.

Table 3

	$10^{\div 8} B_0$ kg/cm ²	$10^{\div 8} B_1$ kg/cm ²	$10^{\div 8} B_2$ kg/cm ²
6—7	6.7	7.6	5.7
7—8	6.5	7.8	5.9
10—11	7.7	8.6	5.3
11—12	7.3	9.6	5.6
14—15	7.6	8.6	5.7
15—16	6.1	12.0	6.9
17—18	6.6	7.1	6.8
18—19	5.8	9.1	6.2
20—21	7.0	6.0	6.6
21—22	5.9	5.6	6.9
23—24	6.8	5.4	7.6
24—25	5.4	6.6	7.8
26—27	7.3	8.2	6.1
27—28	5.4	8.7	8.3
29—30	6.5	5.7	6.8
30—31	5.9	7.9	6.8
Mean	6.5	7.8	6.6

It appears from the table that B_0 , B_1 , and B_2 are almost equally great and show no particular tendency to alterations during yield.

The fairly great dispersion, notably in the determination of B_1 , can be explained by the fact that the magnitudes to the left of the equation mark in the equations determining B_1 and B_2 appear as small differences of about 0.06 mm and 0.12 mm, respectively, between deflexion differences of about 1 mm.

Accordingly, the deflexions of B 1, apart from an indeterminate contribution from a possible plastic hinge under the concentrated force, can be determined with reasonable accuracy by eqs. (1) if we put $B \sim 6.5 \times 10^8$ kgcm² and, cf. fig. 2 for slow tests, $M_u \sim 1050$ kgm.

However, this applies only where the moment under the concentrated

force has touched, or almost touched, M_u , on one single occasion, so that the concrete in the side in tension has cracked. Before crack formation, B was about $20 \times 10^8 \text{ kgcm}^2$.

If B is calculated for a cracked cross section one finds, on the assumption that $E_{steel} \sim 2.1 \times 10^6 \text{ kgcm}^2$ and corresponding to heavy concrete stresses $E_{concrete} \sim 1.4 \times 10^5 \text{ kgcm}^2$, that $B \sim 5.8 \times 10^8 \text{ kgcm}^2$.

The above-mentioned strain gages were placed in the hope that they would be able to show with great accuracy any incipient yield in the reinforcement.

This, however, proved not to be the case.

The gages designated as c in fig. 1 registered no yield until at point 12 on the stress-strain line, where the formation of the plastic hinge, cf. fig. 2, was fairly advanced, and registered no yield after point 20 on the stress-strain line, even if the yield at this juncture was far from completed; this could hardly be due to damage to the gages since these registered the elastic deformations all along.

At points 32 and 33 in fig. 3 yields were registered with the gages designated as b and d in fig. 1.

The strain gage measurements seem to show that the yield in the reinforcement begins in a very narrow zone, which extends gradually as the yield comes to a standstill owing to strain hardening at the places where the yield was initiated.

During the test three major cracks appeared at the tension side of the

Table 4

Point in fig. 2	Crack widths in mm		
	Crack a	Crack b	Crack c
1 and 2	0	0	0
3	0.05	0.04	0.02
4	0.15	0.05	0.10
5	0.20	0.10	0.15
6	0.40	0.15	0.30
7	0.10	0.05	0.10
8	0.35	0.20	0.20
9	0.45	0.25	0.40
10	1.3	0.5	0.8
11	0.9	0.4	0.9
12	1.3	0.5	1.0
14	1.8	1.7	1.0
16	1.6	2.0	1.0
17	1.9	3.3	1.1
18	1.9	3.5	1.0
25	2.0	6.5	0.8
29	2.0	8.5	0.8

beam, a , b , and c , situated about 12, 3, and 13 cm respectively, from the point of attack of the concentrated force.

The crack widths observed appear from table 4 below.

In the preparation of the test data the permanent deformations proved to be practically proportional to the sum of the crack widths a , b , and c , since

$$\frac{a+b+c}{140} \sim \frac{4w_4^{res}}{l}.$$

General information about the main tests

The three other beams were tested continuous over two spans, each of 225 cm, and were loaded with concentrated forces, P_1 and P_3 , at the middle of each span.

The test set-up is shown in figs. 4 and 5.

The force able to produce yield ($M = M_u$) both at the point of attack and over the intermediate support 2, is called P_u , where

$$\begin{aligned} \frac{1}{4} P_u l - \frac{1}{2} M_u &= M_u, \\ P_u &= \frac{6 M_u}{l}. \end{aligned} \quad (2)$$

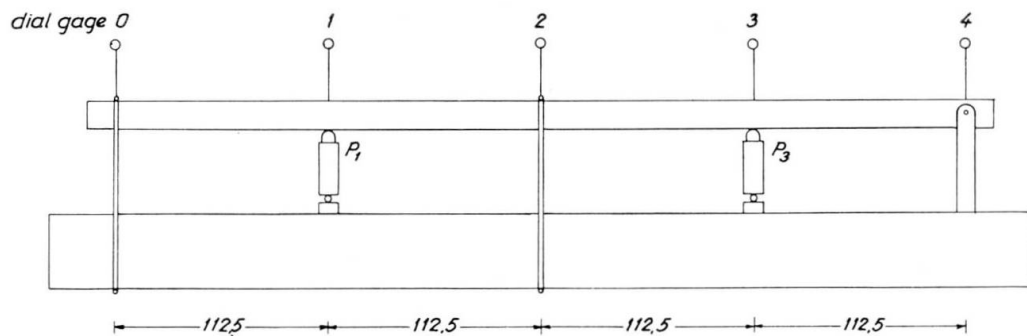

Fig. 4. B II to IV. Sketch of test set-up.

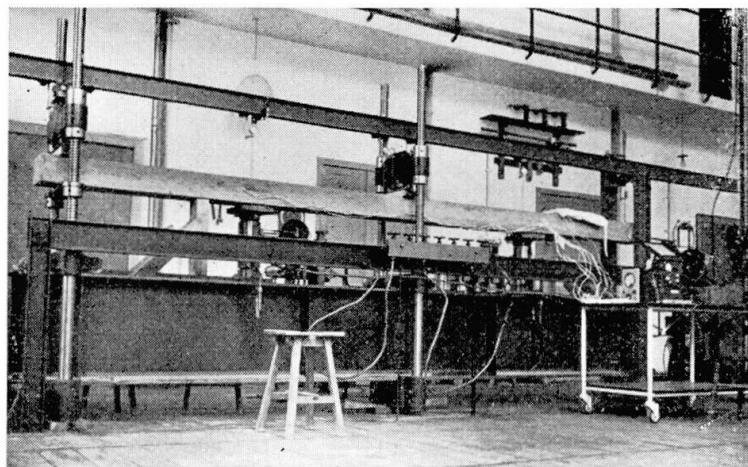

Fig. 5. B II ready to be tested.

From (2), P_u could be theoretically predicted by means of the stress-strain lines of the reinforcement bars and by comparison with the test in respect of B 1; but for the purpose of checking the theoretical value of P_u , all tests were initiated in the following manner:

First, since only positive reactions could be absorbed in the bearings 0 and 2, P_1 and P_3 were allowed to increase simultaneously to a value of about $0.67 P_u$, and then P_3 was allowed to increase alone. At $P_3 = 0.96 P_u$ yield should begin at point 3, and at $P_3 = P_u$ yield should begin at point 2.

The intention was that these stages of the test should be established by means of strain gages on the reinforcement in the relevant cross sections; but, as mentioned under beam B 1, this method failed; it evidently depends on gages having a considerably greater measuring length than those used in these tests.

However, the two above-mentioned values of P_3 also correspond to characteristic points at the deflexion curves for points 1 and 3, and thus the final value of P_u could be established with a fair amount of accuracy.

From this stage of the tests, P_1 was kept constantly equal to $k_1 P_u$, and P_3 varied between 0 and $k_3 P_u$.

If we now assume that the beam deformations can be calculated by means of eqs. (1) it is easily possible, using Bleich's theorem, to find the correlated values of k_1 and k_3 at which the beam can just shake down (and, additionally, find the residual moment M_3' over the intermediate support), since

$$\begin{aligned} M_1^{max} - \frac{1}{2} M_3' &= M_3^{min} + M_3' = M_u, \\ M_1^{max} &= \frac{13}{64} P_1 l, P_1 = k_1 P_u = \frac{6 M_u}{l} k_1, \\ M_3^{min} &= -\frac{6}{32} [P_1 + P_3^{max}] l, P_3^{max} = \frac{6 M_u}{l} k_3 \end{aligned}$$

after which we find

$$k_1 = 1 - \frac{3}{16} k_3. \quad (3)$$

E. g., the beam should just shake down for

$$k_1 = k_3 = \frac{16}{19} = 0.842.$$

A more accurate check on the beam behaviour, however, is obtained by comparing the measured values of deflexions w_1 and w_3 with the theoretical ones calculable from eqs. (1); referring to the test in respect of B_1 we put $B \sim 6.5 \times 10^8 \text{ kg/cm}^2$ (see table 3) and for M_u we insert that value which is directly determined by the test.

Testing of B II

In the testing of B II, k_1 was chosen = $k_3 = 0.90$, so that this beam should have increasing deflexions of point 1.

P_u was found equal to 3180 kg, according to (2) corresponding to

$$M_u = \frac{1}{6} 3180 \times 2.25 = 1190 \text{ kg m.}$$

Readings of the dial gages, in the case of B II and the following beams, after P_u was determined and P_1 adjusted to the value chosen, were made as described below:

1. P_3 was adjusted to the value desired, and a set of readings immediately made.
2. P_3 was kept constant for four minutes.
3. Another set of readings was made.

In figs. 6 and 7 are shown, as abscissa, the measured deflexions of points 1 and 3 (after correction for settlement of supports), $k_3 = \frac{P_u}{P_3}$ being chosen as ordinate. The points observed are connected by solid, straight lines.

The pre-calculated deflexions are shown in figs. 6 and 7 with a dotted curve.

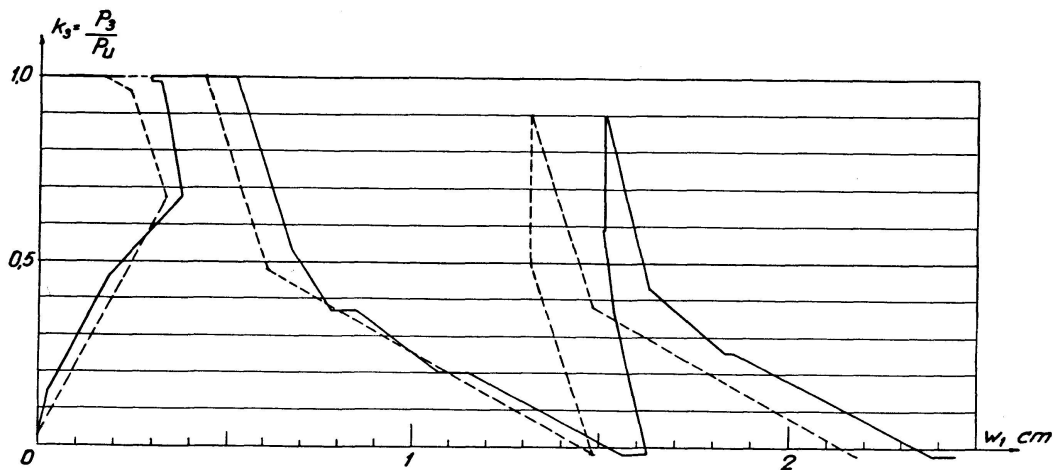

Fig. 6. B II. Theoretical and measured deflexions of point 1.

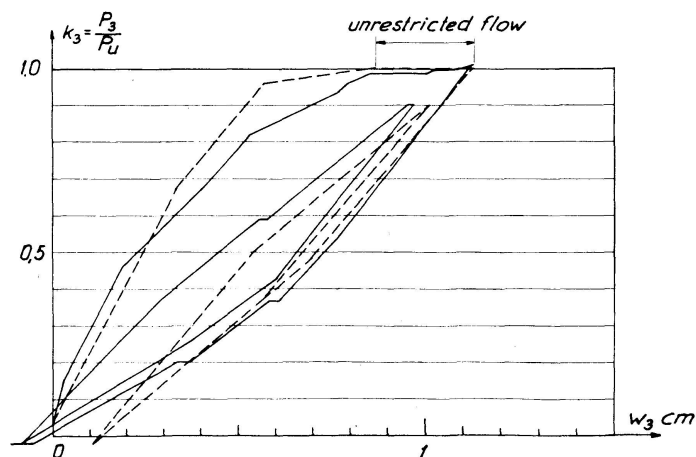

Fig. 7. B II. Theoretical and measured deflexions of point 3.

The agreement between the calculated and the measured deflexions is seen to be excellent, particularly as regards the characteristical course of the curves.

After the first load cycle proper had been established, the hour was so advanced that it would not have been possible to make more than one more cycle with the test velocity envisaged (about 1 hour per load cycle).

The dial gages were then removed, and another 5 load cycles made, each lasting about 12 minutes.

The deflexion of point 1 was registered by the test machine recorder, as shown in fig. 8.

The configuration of the curves, cf. the earlier remarks about the recorder, is not correct, but it appears that the permanent deflexions increase by a virtually constant contribution for each new load cycle. If this contribution is somewhat smaller than it was at the first cycle, it may be ascribed to the increased test velocity.

The deflexion of point 3 was read whenever P_3 was at max. or 0. In agreement with the theory, no increase could be established of the permanent deflexions of point 3. Fig. 9 shows the beam after the test.

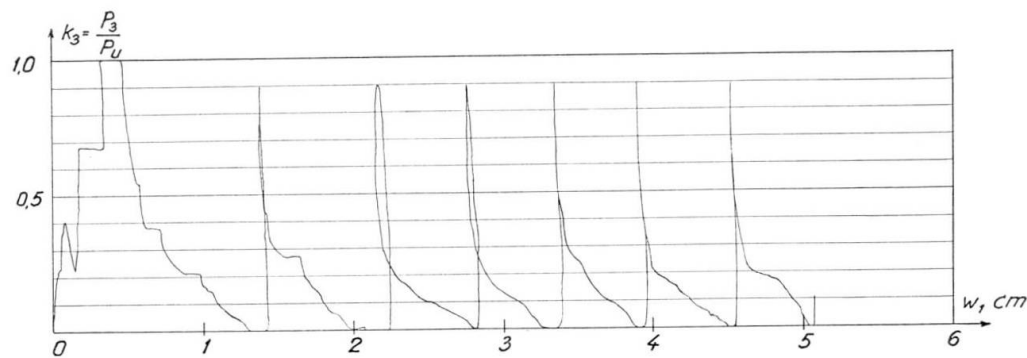

Fig. 8. B II. Deflexion of point 1 registered by the testing machine.

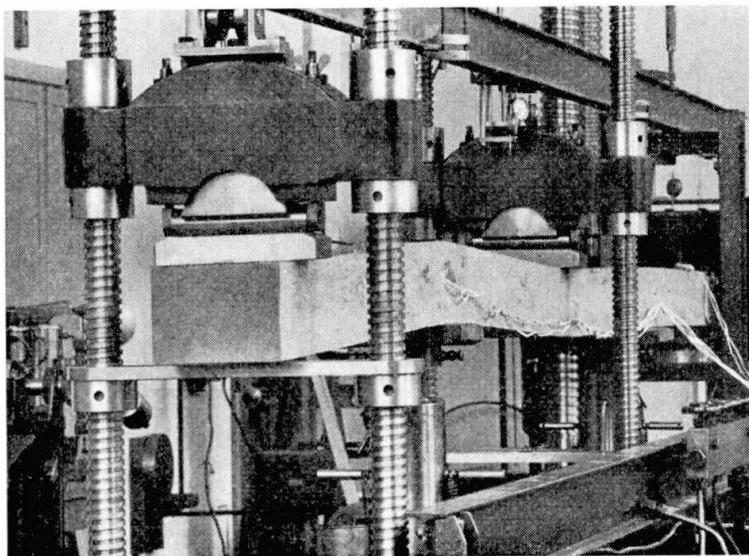

Fig. 9. B II after the test.

Testing of B III

In the testing of B III, k_1 was chosen = $k_3 = 0.842$, so that this beam should just shake down.

P_u was found equal to 3180 kg, according to (2) corresponding to

$$M_u = \frac{1}{6} 3180 \times 2.25 = 1190 \text{ kg m.}$$

In fig. 10 are shown both the measured and the precalculated deflexions of point 1.

According to the theory, the deflexion alterations should have been entirely elastic, after point 3 had been relieved for the first time.

However, it is seen that point 1 receives visible permanent deflexions at each load cycle, but these are decreasing so that it may be assumed that the beam is near shake-down.

In the evaluation of the test it should be borne in mind that a very small inaccuracy in the determination of P_u has a very great influence on the magnitude of the permanent deflexions, seeing that an error of 2% in the determination of P_u may cause that the test is in reality performed with $k \sim 0.86$ instead of 0.842.

For $k_1 = k_3 = k$ the expected permanent deflexion Δw_1 per load cycle for different values of k is listed in table 5.

In the testing of B III Δw_1 was 2.47, 1.49, 0.98, 0.56 mm, respectively.

Now the deviation in the present case is more likely due to the fact that

Table 5

k	0.842	0.85	0.86	0.87	0.88	0.89	0.90
w_1 mm	0.0	1.0	2.2	3.4	4.6	5.8	7.0

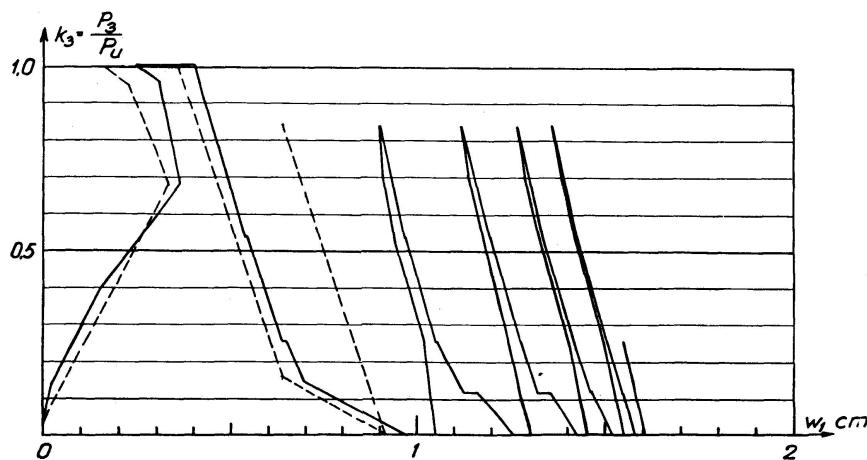

Fig. 10. B III. Theoretical and measured deflexions of point 1.

the moment curvature dependence for B III has had a smoothly curved transitional piece between the two straight lines, this transitional piece more and more approximating the straight lines for each load cycle.

In fig. 11 are shown the measured deflexions of point 3 including the first ordinary load cycle. The deflexions at the next load cycles, for $k_3=0$ and 0.842, were practically identical, but the hysteresis loop-like figure became narrower and narrower, which fact supports the explanation set out above of the beam behaviour.

Testing of B IV

In the testing of B IV, k_1 was chosen = 0.842 and $k_3=0.9$, so that this beam should receive slowly increasing deflexions of point 1.

P_u was found by the previously described procedure to be equal to 2820 kg, according to (2) corresponding to

$$M_u = \frac{1}{6} 2820 \times 2.25 = 1065 \text{ kg m.}$$

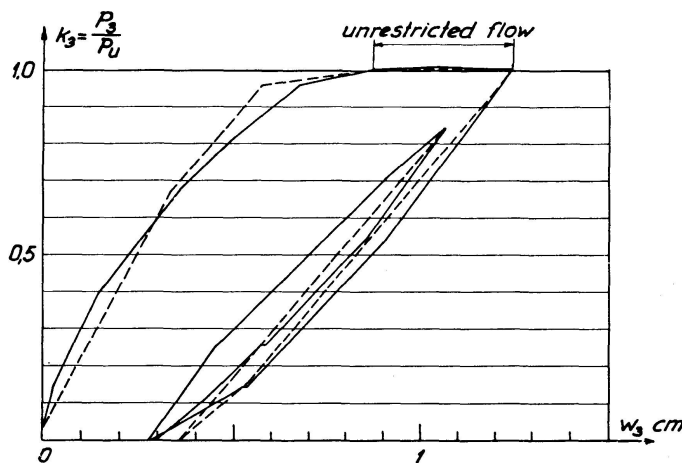

Fig. 11. B III. Theoretical and measured deflexions of point 3.

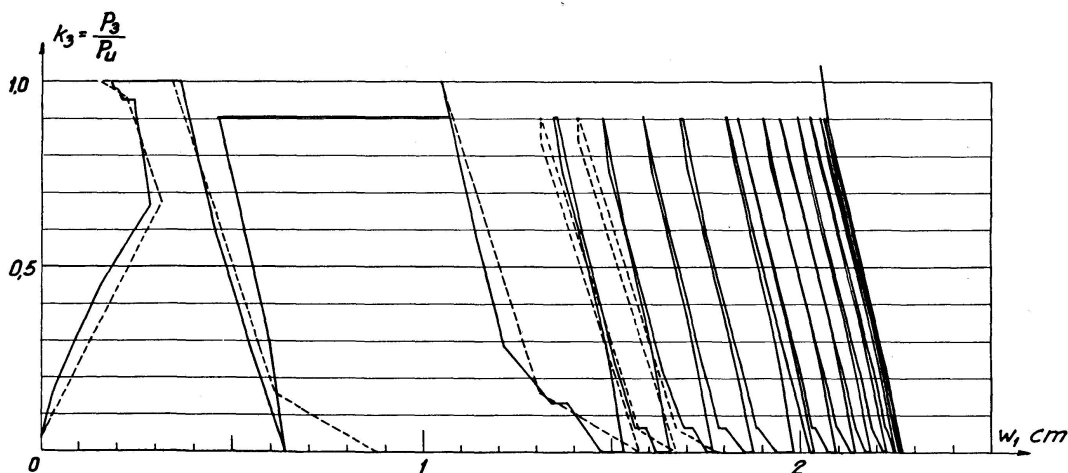

Fig. 12. B IV. Theoretical and measured deflexions of point 1.

In fig. 12 are shown both the measured and the precalculated deflexions of point 1.

The first pressure relief of point 3, contrary to expectation, proved to cause practically no yield at point 1. Therefore, after P_3 had been re-established at $0.9 P_u$ ($k_3=0.9$), P_1 was augmented to enable elucidation of the problem whether the yield moment at point 1 should be greater than at points 2 and 3.

This being done, no symptoms of yield appeared until P_1 reached the value of 3050 kg; but immediately after the onset of the yield the force decreased, after which the yield continued for $P_1 \sim 2870$ kg.

Before the test progressed, checks were made to see whether yield continued to occur in cross sections 2 and 3 for $P_3 = 2820$ kg.

These control measures gave rise to the horizontal line from w_1 equal to about 0.5 to 1.1 cm for $k_3 = 0.9$, with the ensuing sharp rise in fig. 10.

Accordingly, P_1 was put equal to $0.842 \times 2870 = 2420$ kg and the test was resumed until the beam had passed through four ordinary load cycles, the total deflexion of point 1 being about 2 cm.

As appears from fig. 12 there was, at this stage of the test, an excellent agreement between the expected and the established deflexions.

The next day the test was continued, another nine load cycles being performed. In the first five the increment in the permanent deflexion of point 1 was almost constant, if visibly smaller than on the first day, and at last the beam came to an almost complete shake-down.

This must presumably be ascribed to the increase in the reinforcement yield limit that had occurred during the night owing to the cold deformation on the previous day.

In effect, after the test proper had been discontinued, it appeared that P_u at point 1 had increased to 2910 kg against 2870 kg the day before, or about 1.4%, and at point 2 to 2900 kg against 2820 kg, or about 2.8%.

After that, the final part of the test was performed with

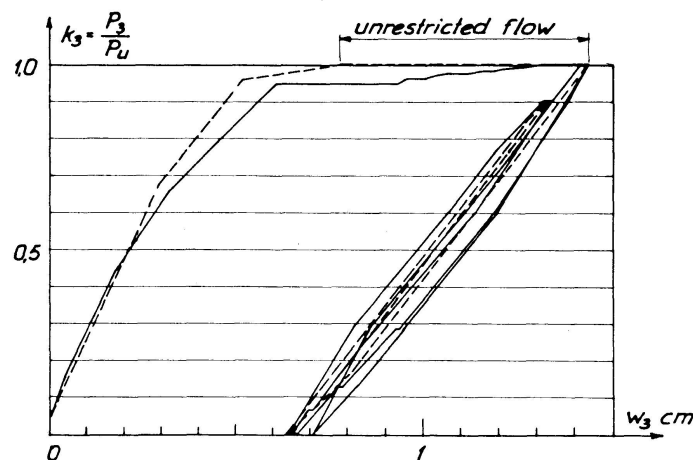

Fig. 13. B IV. Theoretical and measured deflexions of point 3.

$$k_1 \sim \frac{0.842}{1.014} = 0.831,$$

$$\frac{3}{16}k_3 \sim \frac{0.9 \cdot 3}{1.028 \cdot 16} = 0.164,$$

$$k_1 + \frac{3}{16}k_3 \sim 0.995 \sim 1.$$

At these values of k_1 and k_2 the beam should just shake down.

Summary

The tests show that an ordinary concrete beam can be made unserviceable under loads less than those which produce total plastic yield as a consequence of the accumulation of small plastic deformations.

The loads necessary to produce these small plastic deformations were very close to those predicted by the theory, and the deflexions of the beam, residual as well as elastic, could be approximately predicted by assuming a bending moment curvature diagram as shown in fig. 14.

The flexural rigidity of the beams was for $M < M_u$ approximately equal to the theoretical value after crack formation.

M_u was approximately equal to $\Sigma P_y \times h_n$, where P_y (see table 2) is the lower limit for the normal force of the reinforcement bars during yield, determined by tension tests, and h_n is the distance from the centroid of the reinforcement to the compression edge. By comparison between the calculated and the measured deflexions it appeared that the bending moment curvature diagrams for B I and B II were almost exactly as shown in fig. 14 with full-drawn lines.

The diagram for B III apparently showed smooth transition between the two straight lines, but the transitional curve, at repeated yields, increasingly approximated the straight lines, shown as dotted in fig. 14.

In the case of B IV yield did not develop until $M \sim 1.06 M_u$ but was then continued for $M \sim M_u$. When the test was resumed the next day, M_u had increased by a few per cent.

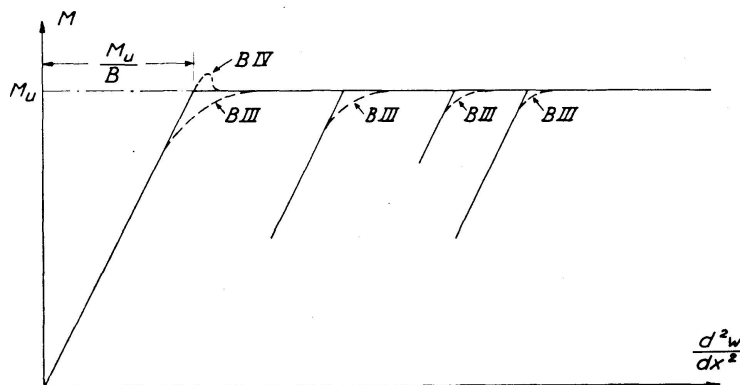

Fig. 14.

References

1. K. KLÖPPEL: Beitrag zur Frage der Ausnutzbarkeit der Plastizität bei dauerbeanspruchten Durchlaufträgern. Final Report, Second Congress, Int. Assn. Bridge and Struct. Engrg., 1936, p. 77.
2. J. DUTHEIL: L'exploitation des phénomènes d'adaptation dans les ossatures en acier doux. Ann. Inst. Techn. Bât. Trav. Publ., janvier 1949, p. 32.
3. J. DUTHEIL: La conception des ossatures métalliques basée sur la déformation plastique, "l'Ossature Métallique" n° 3, 1949, p. 143.
4. CHARLES MASSONNET: Essai d'adaptation et de stabilisation plastique sur des poutrelles laminées. Publications, Int. Assn. Bridge and Struct. Engrg., vol. 13, 1953, p. 239.

Summary

Tests recently made on the Danish Technical University are described.

The main result was as follows:

After cracks have been developed an ordinary reinforced concrete beam with very good approximation behaves as if the bending moment-curvature diagram consists of two straight lines.

Accordingly safe loads with regard to incremental collapse can be evaluated by Bleich's theorem.

Résumé

On décrit les essais faits récemment à l'Université Technique Danoise.

Le principal résultat a été le suivant:

Après l'apparition des fissures, une poutre en béton armé courant se comporte, avec une très bonne approximation, comme si le diagramme moment de flexion-courbure était formé par deux lignes droites.

Ainsi les charges de sécurité, en ce qui concerne la rupture progressive du béton, peuvent être déterminés par le théorème de Bleich.

Zusammenfassung

Es werden die kürzlich an der dänischen Hochschule durchgeführten Versuche beschrieben.

Die hauptsächlichsten Resultate waren folgende:

Nach der Rißbildung verhält sich ein normaler Eisenbetonbalken mit sehr guter Annäherung so, wie wenn die Kurve der Biegemomente sich aus zwei geraden Linien zusammensetzen würde.

Demgemäß können die zulässigen Belastungen mit Rücksicht auf die Vergrößerung der Bruchgefahr nach dem Theorem von Bleich bestimmt werden.