

Developmental morphology of stipules and systematics of the Cunoniaceae and presumed allies. II, Taxa without interpetiolar stipules and conclusions

Autor(en): **Dickison, William C. / Rutishauser, Rolf**

Objektyp: **Article**

Zeitschrift: **Botanica Helvetica**

Band (Jahr): **100 (1990)**

Heft 1

PDF erstellt am: **20.09.2024**

Persistenter Link: <https://doi.org/10.5169/seals-69712>

Nutzungsbedingungen

Die ETH-Bibliothek ist Anbieterin der digitalisierten Zeitschriften. Sie besitzt keine Urheberrechte an den Inhalten der Zeitschriften. Die Rechte liegen in der Regel bei den Herausgebern.

Die auf der Plattform e-periodica veröffentlichten Dokumente stehen für nicht-kommerzielle Zwecke in Lehre und Forschung sowie für die private Nutzung frei zur Verfügung. Einzelne Dateien oder Ausdrucke aus diesem Angebot können zusammen mit diesen Nutzungsbedingungen und den korrekten Herkunftsbezeichnungen weitergegeben werden.

Das Veröffentlichen von Bildern in Print- und Online-Publikationen ist nur mit vorheriger Genehmigung der Rechteinhaber erlaubt. Die systematische Speicherung von Teilen des elektronischen Angebots auf anderen Servern bedarf ebenfalls des schriftlichen Einverständnisses der Rechteinhaber.

Haftungsausschluss

Alle Angaben erfolgen ohne Gewähr für Vollständigkeit oder Richtigkeit. Es wird keine Haftung übernommen für Schäden durch die Verwendung von Informationen aus diesem Online-Angebot oder durch das Fehlen von Informationen. Dies gilt auch für Inhalte Dritter, die über dieses Angebot zugänglich sind.

Developmental morphology of stipules and systematics of the Cunoniaceae and presumed allies.

II. Taxa without interpetiolar stipules and conclusions

William C. Dickison¹ and Rolf Rutishauser²

¹ Department of Biology, University of North Carolina, Chapel Hill, NC 27599-3280 USA

² Institut für Systematische Botanik, Universität, Zollikerstr. 107, CH-8008 Zürich

Manuscript accepted January 5, 1990

Abstract

Dickison W. C. and Rutishauser R. 1990. Developmental morphology of stipules and systematics of the Cunoniaceae and presumed allies. II. Taxa without interpetiolar stipules and conclusions. Bot. Helv. 100: 75–95.

Observations are presented on stipular structure, ontogeny, and nodal vascularization among those genera of the Cunoniaceae and allies lacking interpetiolar stipules. Stipules among all Cunoniaceae and related groups exhibit a morphological continuum that ranges from conspicuous, foliose appendages that are nearly the equivalent of whole leaves, through various structural intermediates, to very reduced and late developing, nonvascularized colleters. In this contribution the following basic patterns of phyllotaxy and stipular development are described: (1) leaves opposite, four stipular primordia arise laterally at each node and subsequently remain independent at maturity (*Bauera*, *Gillbeea adenopetala*); (2) leaves opposite, four stipular primordia arise laterally at each node and the two stipules on either side of the node subsequently coalesce to form a typically bifid mature appendage (*Pseudoweinmannia*, *Geissois biagiana*); (3) leaves opposite, a pair of stipules arise as axillary outgrowths and enlarge to enclose the next youngest leaf pair (*Geissois pruinosa*); (4) leaves opposite, nonvascularized colleters form in a lateral stipular position on each side of the node (*Aphanopetalum*); and (5) leaves alternate, a pair of large stipules develop in association with each leaf primordium (*Davidsonia*). It is suggested that the possession of paired interpetiolar stipules that are entire from inception represents a major synapomorphy for the majority of Cunoniaceae. A similar feature has evolved convergently within the Rosidae in the unrelated genus *Platymiscium* (Leguminosae). With the aid of hypothetical evolutionary scenarios, the systematic implications of the entire range of stipular structure and development in the Cunoniaceae are discussed in relation to Engler's tribal groupings.

Key words: Cunoniaceae, Brunelliaceae, Davidsoniaceae, *Bauera*, stipules, colleters, nodal anatomy, development, systematics.

Introduction

The preceding paper in this series (Rutishauser & Dickison 1989), dealt with stipular morphology and development among taxa of the Cunoniaceae and allies possessing interpetiolar stipules. Interpetiolar stipules are paired structures with each member originating and situated laterally on either side of the stem between the petioles of opposite or whorled leaves. As we pointed out previously, the occurrence of interpetiolar stipules, in which the two stipules associated with two different leaves on the same side of the node are entire from inception, is an uncommon feature among dicotyledons, and, when coupled with the presence of compound leaves, is often used as one of the distinguishing characteristics of the Cunoniaceae. It should be noted, however, that a similar combination of features also occurs in the unrelated genus *Platymiscium* (Leguminosae) within the subclass Rosidae. The stipular pair typically enclose the terminal bud and are usually quickly lost following the resumption of apical growth.

However, not all members of the cunoniaceous complex possess paired interpetiolar stipules. This contribution presents additional, heretofore unreported observations on stipular structure, ontogeny, and nodal vascularization among taxa of the Cunoniaceae and presumed allies that deviate from the more common stipular condition described above. The taxa described are *Aphanopetalum*, *Bauera*, *Brunellia*, *Davidsonia*, *Geissois*, *Gillbeea adenopetala*, and *Pseudoweinmannia*. These new observations provide additional, comparative, developmental evidence leading to a better understanding of character evolution in the family, and are combined with other morphological features to provide an additional basis for a evaluation of the composition and interrelationships among selected genera within this complex and phylogenetically important group.

Materials and methods

Young shoot tips and mature nodes of seven genera and ten species were examined. Materials were prepared and viewed with the scanning electron microscope (SEM) according to methods outlined in the previous contribution (Rutishauser & Dickison 1989). Both microtome sectioned and freehand sectioned nodes were studied to reconstruct patterns of nodal vasculature. Voucher specimens are housed at CANB, NCU, P, Z. Species studied and collection numbers follows.

Baueraceae:

- Bauera capitata* Ser., Australia: Hoogland 11784
- B. rubioides* Andr., Australia: Hoogland 12226

Brunelliaceae:

- Brunellia comocladifolia* N. & B.
subsp. *domingensis* Cuatr. Dominican Republic: Dickison 305

Cunoniaceae:

- Aphanopetalum resinsum* Endl. Australia: Endress 4325
- Geissois biagiana* (F. Mueller) F. Mueller, Australia: Endress 4216
- G. hirsuta* Brongn. & Gris, New Caledonia: Dickison 135
- G. pruinosa* Brongn. & Gris, New Caledonia: Dickison 137
- Gillbeea adenopetala* F. Mueller, Australia: Dickison 207
- Pseudoweinmannia lachnocarpa* (F. Mueller) Engler, Australia: Dickison 209

Davidsoniaceae:

Davidsonia pruriens F. Mueller, Australia: Schneider s. n.

Observations

Geissois Labill.

Geissois is a genus of about 18 species of small- to medium-sized trees that are distributed in Fiji, New Caledonia, the Solomon Islands, and eastern Australia.

Leaves of *Geissois* are digitately trifoliolate or five-foliolate, and opposite in arrangement with associated stipels and stipules (Fig. 30). There are two distinct patterns of stipule development and mature morphology in *Geissois*. Unlike all other Cunoniaceae, each leaf of the New Caledonian and Fijian species, such as *G. pruinosa*, *G. hirsuta*, *G. montana*, and *G. stipularis*, possesses a single, very conspicuous stipule in an axillary position (Fig. 26; Schrödinger 1927). These stipules are oblong, lanceolate, or ovate, and broadly attached at the base. The opposing stipules at a node are free or slightly connate at the base and each stipule is richly vascularized. Each stipular pair is initially coherent, enclosing the next youngest leaf and stipular pair in the sequence (Fig. 27, 28). In the above-mentioned taxa the stipules arise as elongate, broadly-based primordial ridges in the axils of the young leaves, with the two stipules tightly appressed (Fig. 1–3). Stipular margins of *G. pruinosa* are entire, whereas the stipular primordia of *G. hirsuta* show a slight indication of an apical sinus.

A contrasting condition is present in the Australian species *G. biagiana* and *G. benthamiana*. In *G. biagiana* a pair of stipules originate as slender, laterally positioned structures on either side of the node between the opposite leaves. As seen in Figs. 5 and 6, the two stipular primordia on the same side of the stem are free, and appear to have an almost simultaneous initiation with the leaves. During later growth the stipular pair on the same side of the node undergo connation at lower levels. At maturity, leaf pairs are associated with a basally united, bilobed stipular pair on either side of the stem (Fig. 4, 32). Each stipular member is somewhat reniform in outline, with the margins of the two adjoining stipules on either side of the stem overlapping in an axillary position (Fig. 29–31).

The nodal anatomy of *Geissois* ranges from a modified trilacunar to more commonly multilacunar, multitrace, with high numbers of traces occurring in some species (Dickison 1980 b). Stipules are typically supplied by veins branching from the lateral leaf traces (Fig. 25, 29). Figure 29 illustrates a condition whereby a lateral trace divides to supply the two stipules exclusively.

Pseudoweinmannia Engl.

The two species recognized in this genus are confined to eastern Australia, both forming large trees. Leaves are ternately compound (sometimes bifoliolate) and opposite in arrangement. Leaflets have short petiolules and a pair of caducous stipels occur at the distal end of the petiole (Fig. 34). Mature leaf pairs are associated between the petiole bases with a pair of small, lanceolate-shaped interpetiolar stipules that are quickly shed (Fig. 35). Stipular ontogeny of *P. lachnocarpa* commences with the formation of four stipular primordial lobes. During early development a pair of free stipular primordia are located on either side of the node between the incipient leaves (Fig. 7). Subsequent

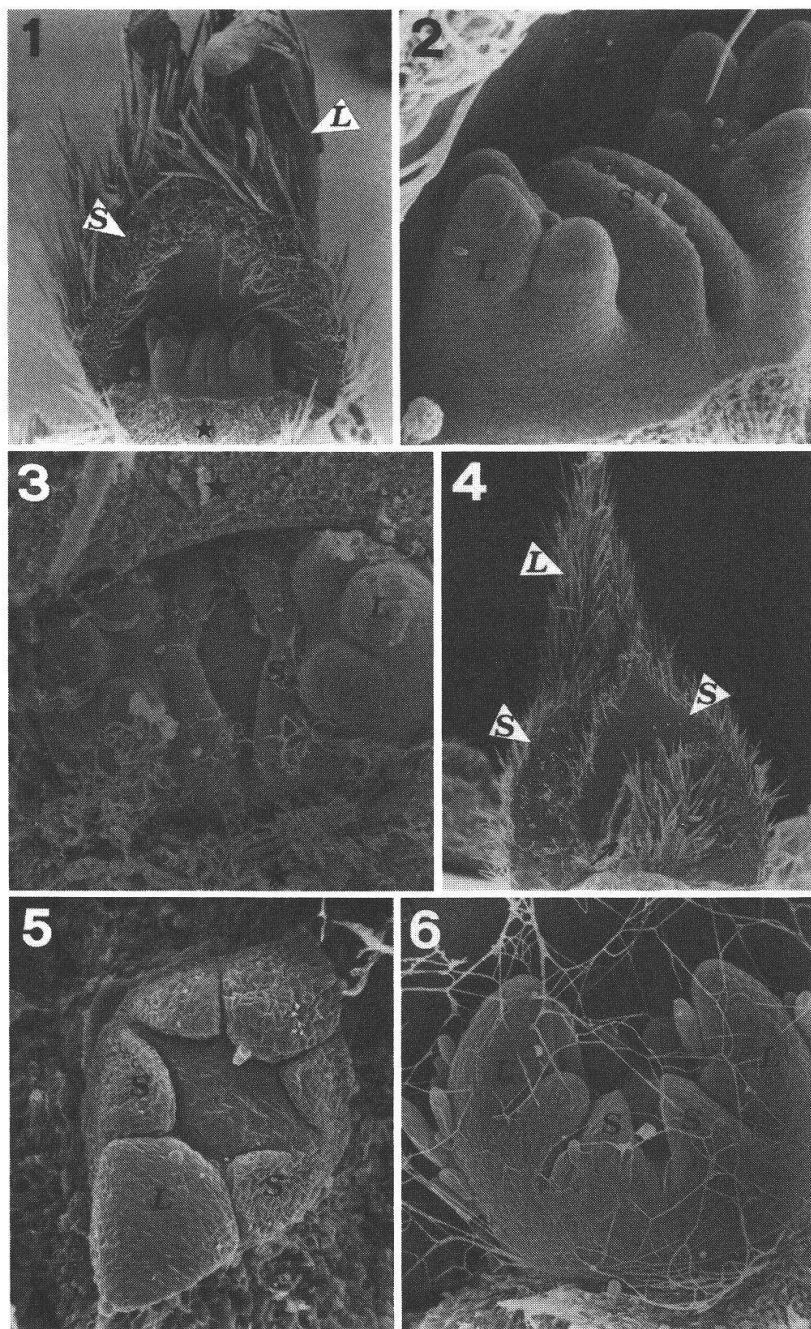

Figs. 1–2. *Geissois pruinosa* (Dickison 137). 1. Shoot tip with one flap-like, axillary stipule (S) and its associated leaf (L). An opposing stipule and leaf have been removed (*). Stipular pair S totally enclose the next youngest leaf and stipular pairs ($36\times$). 2. Enlarged view of same tip viewed in Figure 1, showing an early development of digitate leaves (L) and paired, axillary stipules (S) ($140\times$).

Fig. 3. *G. hirsuta* (Dickison 135). Shoot tip as viewed from above. An older stipular pair (*) have been removed to show the developing compound leaves (L) and paired, axillary stipules (S). Note that the stipules show some indication of an apical sinus ($150\times$).

Figs. 4–6. *G. biagiana* (Endress 4216). 4. Young leaf (L) with its two lateral stipules (S) as seen from the adaxial side. Note that the two stipules show considerable overlap. Arrow indicates the next younger leaf pair of the same shoot tip ($16\times$). 5. Another shoot tip viewed from above. A young leaf pair (L) are associated with a pair of developing lateral stipules (S) on either side of the node ($250\times$). 6. Shoot tip showing an older stage of leaf development. The pair of compound leaves (L) are accompanied by a pair of lateral stipules (S) on either side of the node ($140\times$).

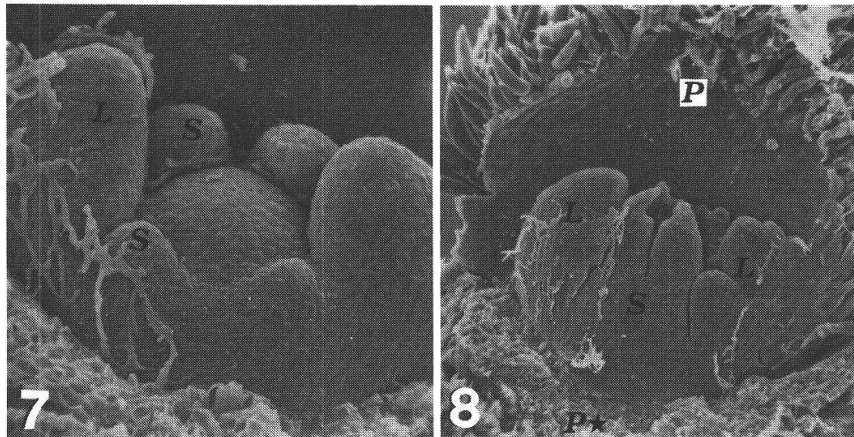

Figs. 7–8. *Pseudoweinmannia lachnocarpa* (Dickison 209). 7. Shoot tip showing developing leaf pair (L) and associated stipules (S). Note the two stipular primordia on each side of the node are free ($320\times$). 8. Axillary bud after removal of one prophyll scale (P*). The second leaf pair (L) is evident along with an associated deeply bifid interpetiolar stipule (S) ($130\times$).

growth results in the connation of the two stipules on the same side of the stem by a basal elongation of the common sheath area (Fig. 8, 35). Thus, the bifid apex becomes quite inconspicuous or even invisible on mature interpetiolar stipules. The nodal anatomy of *Pseudoweinmannia* is trilacunar, three-trace, with each stipule having a vascular connection with the two nearest lateral leaf traces (Fig. 33).

Gillbeea F. v. Muell.

Gillbeea is composed of two species of medium-sized to large trees distributed in northeastern Queensland and northeastern New Guinea. Leaves are decussate and imparipinnate. According to Hoogland (pers. comm.) only *G. papuana* has united interpetiolar stipules (see also Engler 1928: Fig. 141). *Gillbeea adenopetala* is characterized by possessing free, lateral stipules, i.e., the two stipules on the same side of the stem are not united at maturity (Fig. 37). The two pairs of lateral stipules in *G. adenopetala* arise almost concomitant with the development of a leaf pair and are recognizable as independent and slightly later forming bulges on either side of the apex (Fig. 9, 10). At maturity individual stipules are large, asymmetrical, narrowly attached at the base, and strongly unequal-sided. Each stipule is obtuse, rounded, or acute at the apex (Fig. 38). Stipules show a prominent venation consisting of a distinct midrib and lateral veins. The nodal anatomy of *Gillbeea* is trilacunar, three-trace with each leaf supplied by a median and two lateral traces. Stipules are vascularized by strands arising from the lateral leaf traces (Fig. 36). *Gillbeea* (at least *G. adenopetala*) deviates from most other Cunoniaceae in two inflorescence features: the bracts possess two lateral lobes (teeth) representing attached stipules, and the phyllotaxy along the main inflorescence axis switches from decussate to spiral (see Engler 1928: Fig. 141; Hoogland 1960).

Aphanopetalum Endlicher

The systematic relationship of this small Australian genus are quite unclear. In contrast to typical Cunoniaceae, *Aphanopetalum* is a liana or climbing shrub without obvious stipules. In *Aphanopetalum resinosum* small colleters are located in a lateral stipular position on each side of the node at which oppositely arranged, simple leaves are

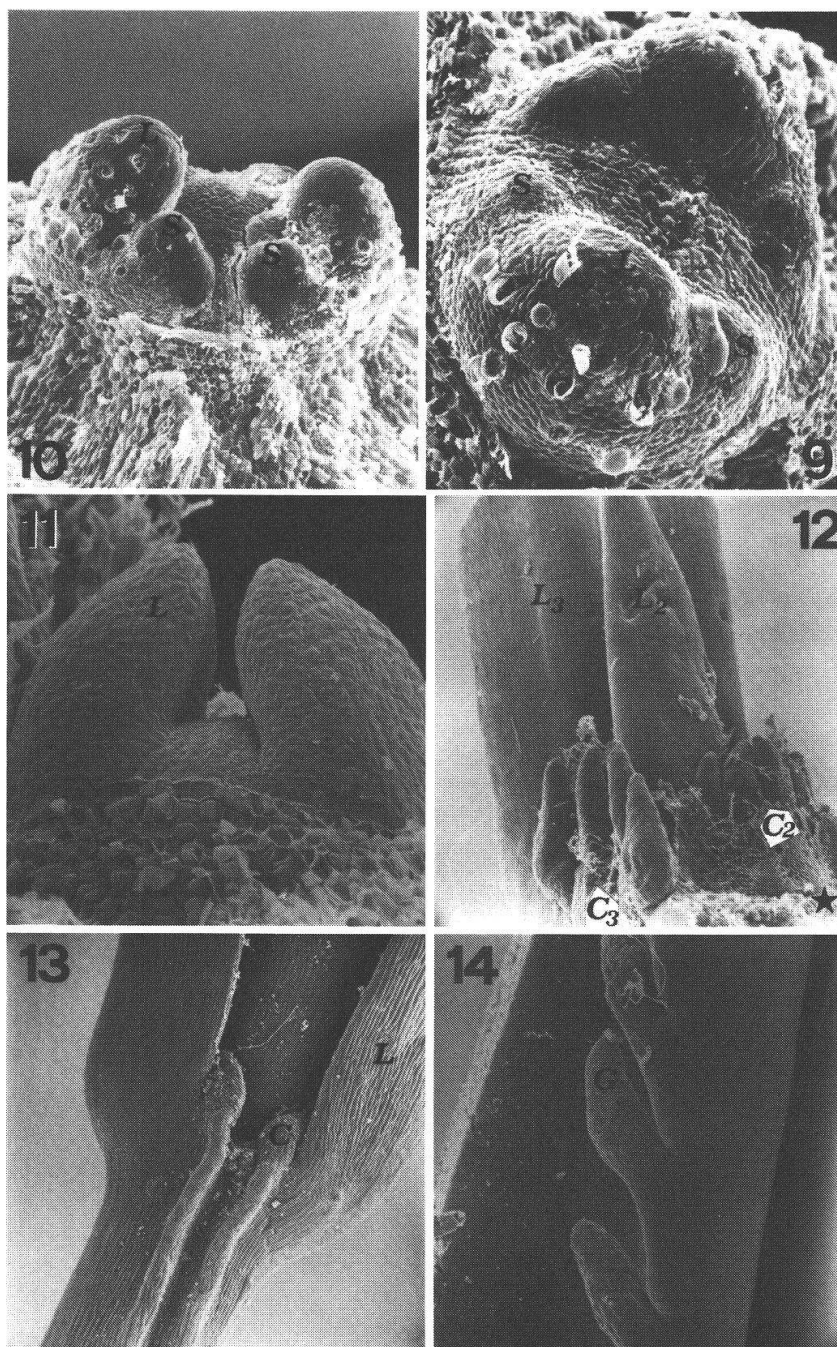

Figs. 9–10. *Gillibea adenopetala* (Dickison 207). 9. Shoot tip showing early stage of development of a leaf pair (L) and the initial stage of development of two pairs of lateral stipules (S) ($300\times$). 10. Shoot tip with leaf pair (L) and associated stipules (S) at a later stage of development ($200\times$).

Figs. 11–14. *Aphanopetalum resinosum* (Endress 4325). 11. Shoot tip with a pair of young leaves (L). Lateral colleters have not yet begun to develop ($300\times$). 12. Shoot tip showing two leaf pairs (L_2/L_3). One leaf from each pair has been removed (*). C_2 indicates the four colleters in a stipular position associated with the younger leaf pair, and C_3 indicates the four colleters in stipular position on one side of the older leaf pair ($50\times$). 13. Stem node and base of leaf pair (L) in flower producing region, with only two colleters (C) on each side of leaf pair. Note ridges on internode terminating with colleters ($50\times$). 14. Glandular teeth (G) on the leaf margin, strongly resembling the colleters in a stipular position (see above) ($100\times$).

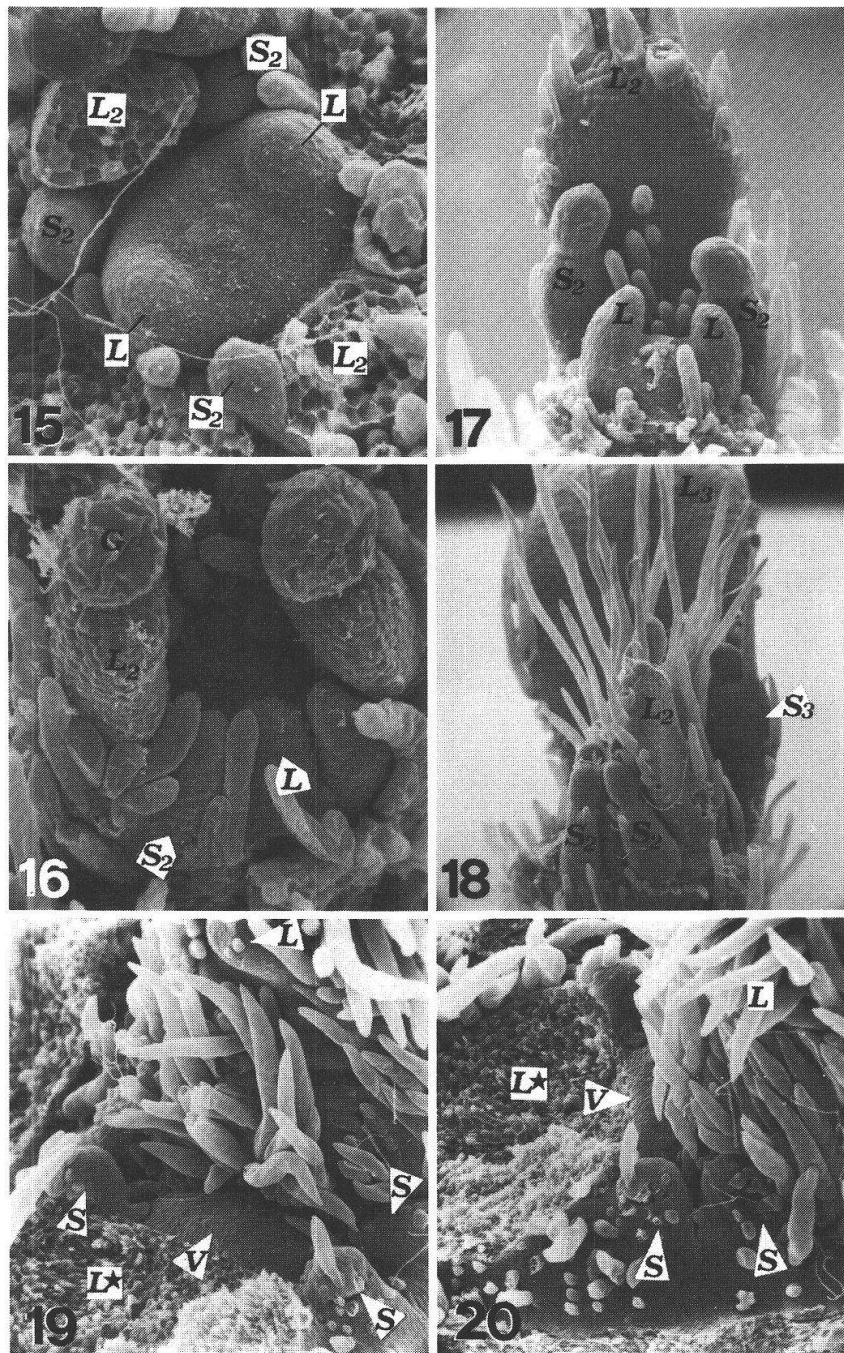

Figs. 15–16. *Bauera capitata* (Hoogland 11 784). 15. Shoot tip with a single pair of leaf primordia (L). The next older and partly removed leaf pair is indicated by L₂. S₂ = stipular primordia in lateral position to leaf pair L₂ (350 ×). 16. Another shoot tip, with two pairs of young leaves (L/L₂). The blades of L₂ are provided with apical glands (G) and lateral stipules (S₂) are present (350 ×).

Figs. 17–18. *B. rubioides* (Hoogland 12226). 17. Shoot tip showing youngest developing leaf pair (L). At this stage of development stipules are not evident. One leaf (L₂) and associated stipules are observable from the next older leaf pair. Note swollen, glandular apices on stipules (S₂) (170 ×). 18. Another shoot tip with two leaf pairs (L₂/L₃) and accompanying lateral stipules (S₂/S₃). One leaf from each leaf pair has been removed. Note both leaves and stipules have glandular apices (80 ×).

Figs. 19–20. *Brunellia comocladifolia* subsp. *domingensis* (Dickison 305). 19. Shoot tip with a leaf pair (L) and associated lateral stipular primordia (S). One leaf has been removed (L*). V = shoot apex (150 ×). 20. The same shoot tip as viewed in Figure 19. Note the developing stipular pair (S) on the same side of the node are closely spaced at the base (130 ×).

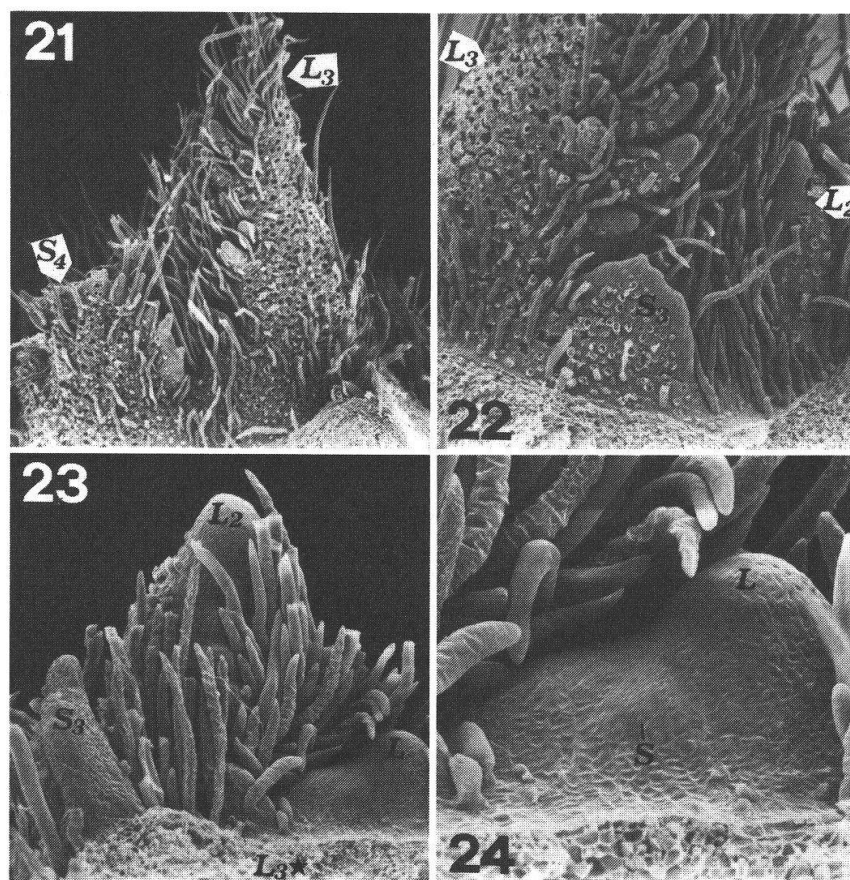

Figs. 21–24. *Davidsonia pruriens* (Schneider s.n.). 21–22. Shoot tip seen from two opposite sides. The leaves (L) are arranged spirally, each one with two scale-like lateral stipules (S) and two rows of pinnae. Numerals according to the relative age of the leaves and stipules. In Fig. 21 stipules (S_4) of next older leaf observable, margins with prominent glandular teeth ($45\times$, $90\times$). 23–24. The same shoot tip as above, after removal of S_4 and L_3^* . Shoot apex observable with youngest leaf primordium (L) and initial stage of adjacent stipule (S) ($140\times$, $360\times$).

Figs. 25–28. *Geissois pruinosa*. 25. Schematic reconstruction of nodal vascularization. 26. Shoot tip showing pair of prominent axillary stipules, associated leaves (*) removed ($1.5\times$). 27. External view of terminal bud ($1.5\times$). 28. Terminal bud with one protective stipule (bud scale) removed to show next younger leaf pair ($3.5\times$).

Figs. 29–32. *Geissois biagiana*. 29. Schematic reconstruction of nodal vascularization. 30. Leaf, with foliaceous stipules. Note stipels at distal end of petiole ($0.2\times$). 31. Details of overlapping stipules ($0.9\times$). 32. Basally united stipular pair ($0.9\times$).

Figs. 33–35. *Pseudoweinmannia lachnocarpa*. 33. Schematic reconstruction of nodal vascularization. 34. Leaf showing stipels at distal end of petiole ($0.25\times$). 35. Stipule, bifid apex not visible ($10\times$).

Figs. 36–39. *Gillbeea adenopetala*. 36. Schematic reconstruction of nodal vascularization. 37. Shoot tip showing a pair of opposite leaves and two independent stipules on each side of the node ($1.5\times$). 38. Stipule, with stalk-like base ($2.5\times$). 39. Bract with attached stipular lobes (S) ($4.5\times$).

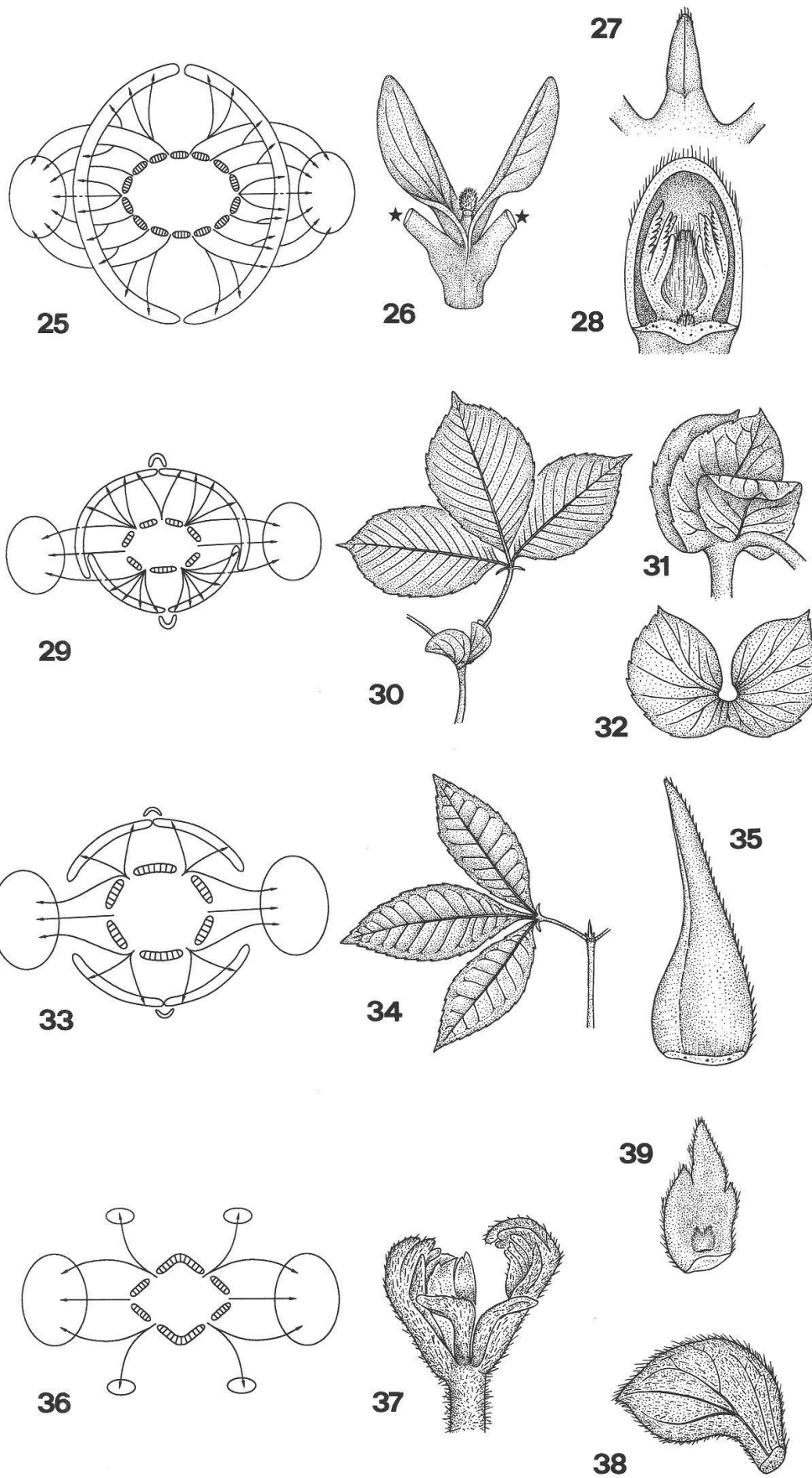

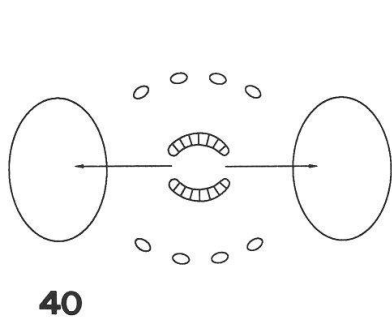

40



41

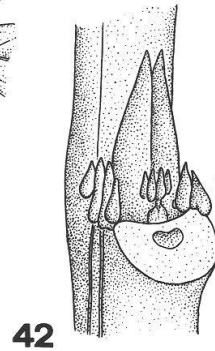

42

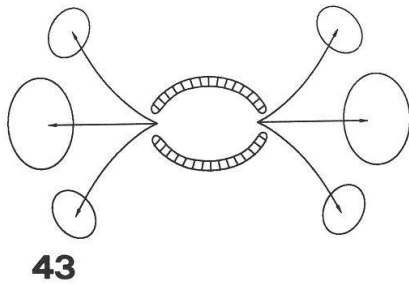

43

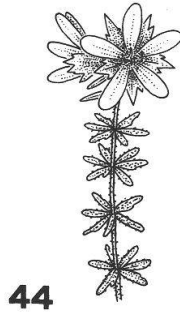

44

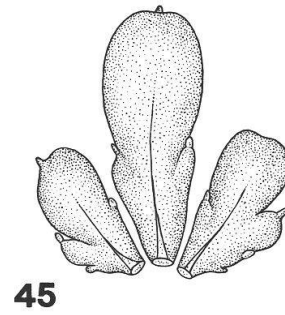

45

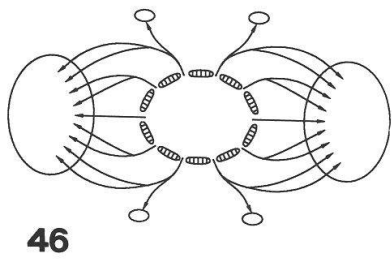

46



47

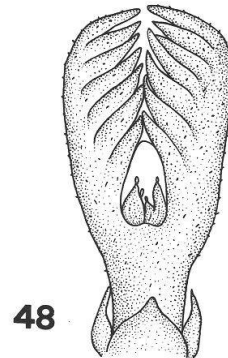

48

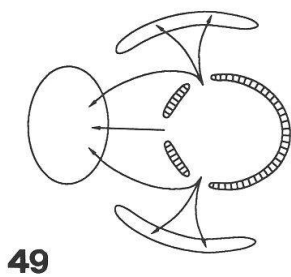

49

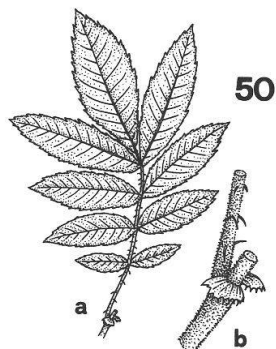

50

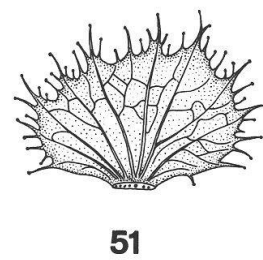

51

attached (Fig. 12, 41, 42). Figure 13 shows only two colleters on each side of the node from flower producing regions of the stem. Colleter development at the node commences after the pair of leaf primordia have completed early development (Fig. 11, 12). At maturity the colleters are unvascularized and resemble the glands located along the leaf blade margins (Fig. 12, 14). The sister species, *A. clematideum* shows regularly only two small colleters on each side of the foliage leaf pair. Each leaf of *Aphanopetalum* receives a single flat arc of vascular tissue that diverges from a single gap in the cauline stele (Fig. 40).

Bauera Banks (Baueraceae)

Bauera is a genus of about three species of scrambling shrubs from eastern Australia and Tasmania. As interpreted here, *Bauera* produces opposite, simple leaves with each leaf blade associated with a pair of prominent, somewhat asymmetric stipules (Fig. 44, 45). As seen in Figs. 15–18, leaf and stipular development follows a pattern that is similar to *Gillbeea adenopetala*. The opposing leaf primordia are associated with a pair of free, stipular primordia on either side of the node. The stipular primordia arise somewhat later than the foliar primordia (Fig. 15). Both young leaves and stipules have protuberant apical and marginal glands (Fig. 16, 17, 45). A single leaf trace originates from a single gap in the cauline stele and immediately trifurcates to supply the leaf blade and two stipules each with a single vascular bundle (Fig. 43).

Brunellia Ruiz and Pavon (Brunelliaceae)

Some 62 species have been recognized in this exclusively Neotropical genus that is placed in the monogeneric family Brunelliaceae, and considered to have close, sister group affinities with the Cunoniaceae. Species of *Brunellia* have simple (unifoliolate) or compound (imparipinnate) leaves that are opposite or arranged in whorls of three. Leaves are associated with a pair of diminutive, laterally attached, lanceolate or subulate, usually entire but also dentate or incised primary stipules (Cuatrecasas 1970, Weberling 1976) (Fig. 47, 48). Stipules are usually only about 2–3 mm long (up to 5 mm in *B. costaricensis*, Weberling 1976). In *B. comocladifolia* subsp. *domingensis* the stipular pair on the same side of the stem originate as closely spaced but independent lateral

Figs. 40–42. *Aphanopetalum resinosum*. 40. Schematic reconstruction of nodal vascularization. 41. Terminal portion of young shoot showing decussate leaves (0.35 ×). 42. Detail of shoot tip illustrating two leaf pairs with laterally positioned colleters (15 ×).

Figs. 43–45. *Bauera capitata*. 43. Schematic reconstruction of nodal vascularization. 44. Terminal portion of flowering shoot with hexamerous pseudo-whorls formed by stipular leaf pairs (0.5 ×). 45. Developing leaf and associated stipular pair (18 ×).

Figs. 46–48. *Brunellia comocladifolia* subsp. *domingensis*. 46. Schematic reconstruction of nodal vascularization. 47. Shoot tip showing developing leaf pair (0.25 ×). 48. Terminal bud with young leaves and associated lateral stipules, each glandular tipped (2.3 ×).

Figs. 49–51. *Davidsonia pruriens*. 49. Schematic reconstruction of nodal vascularization. 50 a, b. Leaf and associated stipules (0.1 ×, 0.3 ×). 51. Stipule (2 ×).

primordia, and remain free from each other to the base at maturity (Fig. 19, 20). In various species each lateral stipule is incised down to the base, thus four outgrowths (stipules) occur on either side of the node (Cuatrecasas 1970, 1985, Weberling 1976). As compared with leaves, stipular development is delayed and individual stipules elongate very little. Our observations confirm the findings of Sinnott (1914) that the nodal anatomy of *Brunellia* is variable. Three leaves per node are present in *B. acutangula*, with each leaf receiving three traces that arise from an equal number of gaps. Pentalacunar, five-trace nodes occur in *B. comocladifolia* subsp. *domingensis*, a species with opposite leaves. In the latter case, the two pairs of lateral leaf traces produce numerous branches, some of which extend to the stipules (Fig. 46).

Davidsonia F. v. Muell. (Davidsoniaceae)

The Davidsoniaceae, a monotypic family, is represented by *Davidsonia pruriens* of northeastern Australia. The species is allied with Cunoniaceae in all modern systems of classification, but differs most notably by the alternate leaf arrangement, presence of rigid, stinging hairs, having stamens scarcely exerted, and in having exalbuminous seeds (Bange 1952, Cronquist 1981, Smith 1985). Leaves of *Davidsonia* are large, pinnately compound, and each is associated with a pair of large, lateral stipules (Fig. 50). Mature stipules are broader than high (ca. 1 cm × 1.6–2.0 cm) and ovate to reniform or subreniform in shape with sharply dentate to serrate, glandular margins (Fig. 51). Early development stages of the spirally initiated leaf primordia and scale-like stipules are seen in Figs. 21–24. It is evident that the undivided stipular primordia originate somewhat later than the associated leaf primordium. The nodal anatomy of *Davidsonia* conforms to the trilacunar, three-trace pattern, with each stipule receiving branch traces from the nearest lateral leaf trace (Fig. 49).

Discussion

1. Ontogenetic considerations

From the above observations, and those presented in the previous paper in this series (Rutishauser & Dickison 1989), it is apparent that there is considerable variation within the Cunoniaceae and allies in leaf morphology and associated stipular structure and development. A range of variation is evident in stipular size, position, vascularization, degree of independence, and manner of development. At maturity, stipular pairs are either totally free, or united to various degrees so that a single pair of mostly interpetiolar stipules is associated with one leaf pair. Individual stipules have entire margins or are variously apically toothed or bifid. Furthermore, stipules of the Cunoniaceae and allies exhibit a morphological continuum that ranges from conspicuous appendages that are nearly equivalent to whole leaves, through various structural intermediates, to very reduced and late developing, nonvascularized glandular colleters of the type found in *Aphanopetalum*. Similar transitions are present among certain representatives of the Rubiaceae and Leguminosae (Rutishauser 1984, Rutishauser & Sattler 1986), and support the partial homology (morphological equivalence) of leaf and stipule.

The genus *Bauera* is of particular interest in this regard. In contrast to all typical Cunoniaceae, *Bauera* has often been described as exstipulate (Velenosky 1913, Troll 1939, Dickison 1980 b, Beadle, Evans & Carolin 1963). Following this interpretation, the

lateral leaf parts of *Bauera* are accepted to be components of a tripartite leaf or the genus is described as having whorled phyllotaxis with six leaves per node. However, we now support the tentative conclusion of Airy Shaw (in Willis 1973) and Hils (1989), who regard *Bauera* to possess decussate leaves, with each leaf composed of a blade and an associated pair of essentially equal and free stipules that are separately inserted at the node. The interpretation that the lateral foliose structures are stipules is a view supported by developmental evidence. Not only are the two pairs of stipules initiated as laterally positioned structures on either side of the opposing leaf primordia, they originate as later outgrowths from the shoot apex rather than from the base of the leaf primordium, which at this stage of development have reached a length of approximately 70 μm . The fact that the stipular vascular supply originates as a branch from the single leaf trace, as well as the structural similarity between the lateral members and the median leaf, might be taken as criteria against the stipular interpretation of the lateral appendages in *Bauera*. However, the same set of features also occurs in the nodal whorls of *Galium* and its allies (Rubiaceae) without causing concern to adherents of the view that the lateral appendages in this genus are stipules (see Rutishauser 1984). An acceptance of the conclusion that the basal pinnae of *Bauera* are modified stipules brings the genus into conformity with other Cunoniaceae.

Melville (1972) argued that the Cunoniaceae exhibit a phylogenetic transformation series beginning with a single pair of large, totally united interpetiolar stipules (bud scales) at each node, and culminating in two pairs of reduced and simplified lateral appendages per node that are completely disassociated. The unfused stipules of *Gillbeea adenopetala*, accordingly, were seen as a derived state. In this series of studies we have described some species of Cunoniaceae and allies with mature stipules that are apically bilobed (e.g., *Caldcluvia*, *Callicoma*, *Eucryphia*). Bilobed stipules often start their development as two independent primordia, that only subsequently become confluent. This is especially evident in *Pseudoweinmannia lachnocarpa*, in which stipules arise as completely independent and free primordia, whereas at maturity the stipular pairs on either side of the stem are united. It is of particular interest that the fagaceous species *Trigonoblanus verticillata* also combines whorled leaves with free stipules on young shoot tips and stipules partially and entirely connate in pairs at mature nodes (Forman 1964). Based upon similar observations in other dicotyledons, some botanists have concluded that lateral stipules (four per leaf pair) are probably the primitive, or plesiomorphic, condition from which interpetiolar stipules were derived by the gradual union of adjacent appendages on each side of the node (Dickison 1980b). Accordingly, the union of the pair of stipules on the same side of the stem would be interpreted as a salient trend of structural specialization in the Cunoniaceae, that is associated with both opposite and whorled, as well as simple and compound, leaves. This view is especially attractive to proponents of the classical leaf-stipule concept. However, according to the alternative, and equally compelling, modified leaf-stipule concept discussed in the previous paper in this series (Rutishauser & Dickison 1989), one may accept the condition of entire interpetiolar stipules as such, without invoking speculation about an origin by congenial fusion of lateral stipules. It is noteworthy in either case, that in the genera *Caldcluvia* (sensu Hoogland 1979) and *Gillbeea*, both lateral stipules (*C. paniculata*, *G. adenopetala*) and interpetiolar stipules (*C. australiensis*, *G. papuana*) occur.

Another divergent development pattern is present among certain species of *Geissois*. In contrast to the usual position of stipules as lateral appendages, the stipules of New Caledonian and Fijian species of *Geissois* arise as broadly based, axillary structures, although the paired, axillary stipules continue to enclose the terminal bud in a manner

similar to other Cunoniaceae. It is significant, however, that stipules of the Australian species, such as *G. biagiana*, have retained the typical cunoniaceous early developmental sequence, arising as paired lateral outgrowths with a tendency to form bifid interpetiolar stipules.

2. Systematic conclusions

The most recent classification of the Cunoniaceae was proposed by Engler (1928). The naturalness of Engler's tribal characterizations, however, has been seriously questioned (Dickison 1980a, 1984) and the suggestion raised that they should be either partially reconstructed or abandoned. The intent of the following discussion is to further synthesize available morphological and anatomical information in an attempt to resolve generic and tribal relationships among Cunoniaceae.

Engler recognized five tribes within the Cunoniaceae, distinguished by the following structural and anatomical features:

1. BELANGEREAE, Stamens many; petals absent; carpels 2, superior; leaves digitate.
2. SPIRAEANTHEMEAE, Stamens equal in number to or twice as many as sepals; carpels 3–5, sometimes, 2, superior.
3. CUNONIEAE, Stamens equal in number to or twice as many as sepals; carpels 2, superior; flowers simple or compound, but not in clustered inflorescences.
4. PANCHERIEAE, Flowers in ball-shaped clusters; stipules fused in pairs.
5. PULLEAE, Carpels 2, fused, half-inferior, always with 3 distichous, upright ovules; petals absent.

The Cunoniaceae are united by being an exclusively woody group with nearly all genera currently recognized in the family distributed in the Australian and New Caledonian area. *Lamanonia*, from South America, and *Platylophus*, from South Africa, are the only genera found exclusively outside this general area. The family is generally characterized by leaves pinnately compound or simple, opposite or whorled, and, as described in this and the preceding paper, that are often associated with generally conspicuous, paired, interpetiolar stipules. Flowers are basically pentacyclic and obdiplostemonous but not exclusively so (see Dickison 1989). Seeds have a straight embryo embedded in abundant endosperm and seed coats are derived from both integuments and, importantly, have a single fibrous layer that is derived from the outer epidermis of the inner integument.

Characters selected for analysis and their suggested character state polarities are listed in Table 1. Included among the characters selected are those that have historically been used to delimit genera within the family as well as ones that have only recently proven to be systematically useful. Our analysis of characters among selected genera of the Cunoniaceae and presumed allies has resulted in the hypothetical phylogenetic tree shown in Fig. 52 with an alternative for Engler's Belangereae shown in Fig. 53. The principal synapomorphies within the family are indicated and Engler's tribal concepts are encircled. Although character polarity determinations could not be made for a few characters these features are also depicted on the tree. If a genus shows a strong tendency for a particular character state transformation the apomorphic state is placed in parenthesis. It is important to point out that the scenarios reproduced here (Fig. 52, 53) were not constructed using rigid cladistic methods, and therefore may not be the most parsimonious. Nevertheless, we feel they are useful in illustrating principal character state transformations and in the discussion of generic relationships that follows.

Table 1. Characters analyzed

Character	Plesiomorphic State	Apomorphic State(s)
1. Plant habit	A, shrub or tree	A1, subshrub; A2, liana
2. Inflorescence type	B, paniculate	B1, racemose or spike-like; B2, spherical heads; B3, solitary flowers
3. Flower sexuality	C, bisexual	C1, unisexual
4. Plant sexuality	D, monoecious	D1, dioecious
5. Aestivation	E, valvate	E1, imbricate
6. Corolla type	F, petals present	F1, petals absent
7. Petal form	G, petals entire	G1, petals forked
8. Sepal number	H, 4 or 5	H1, 6
9. Stamen number	I, 8–10	I1, numerous
10. Gynoecial type	J, apocarpous	J1, syncarpous
11. Ovary position	K, superior	K1, half-inferior or inferior
12. Stigma type	L, terminal	L1, decurrent
13. Ovule number per carpel	M, 2	M1, more than 2
14. Fruit type	N, dehiscent	N1, indehiscent
15. Pericarp structure	O, endocarp present	O1, endocarp absent
16. Seed type	P, winged	P1, nonwinged
17. Seed surface	Q, variously reticulate	Q1, papillate; Q2, hairy; Q3, elaiosomes
18. Seed position	R, seed enclosed	R1, seed exposed at maturity
19. Seed coat structure	S, fibrous layer present	S1, fibrous layer absent
20. Leaf type	T, imparipinnate	T1, digitate; T2, unifoliolate
21. Leaf arrangement	U, spiral	U1, decussate; U2, whorled
22. Stipular position	V, lateral stipules	V1, interpetiolar; V2, axillary
23. Stipular structure	W, secretory ribs absent	W1, secretory ribs present
24. Stipular size	X, moderate	X1, diminutive
25. Nodal anatomy	Y, trilacunar, 3-trace	Y1, multilacunar; Y2, unilacunar; Y3, split-lateral traces
26. Perforation plate type	Z, scalariform	Z1, scalariform and simple; Z2, simple

We have independently reached the same conclusion as Kalkman (1988), that the character state of decussate (or verticillate) leaves is the oldest and apparently only synapomorphy for the entire family, although it is of interest to note that there has occurred a reversal to spiral phyllotaxy in the inflorescence of *Gillbeea* and *Caldcluvia* (see Hoogland 1960). The occurrence of decussate, pinnately compound leaves in association with interpetiolar stipules bearing colleters in the genus *Platymiscium* (Leguminosae) is clearly an example of convergent evolution (Rutishauser & Dickison 1989). A convincing demonstration of monophyly using a suite of uniquely derived character states is lacking for the Cunoniaceae. The closest sistergroup(s) of the Cunoniaceae is not



Fig. 52. Evolutionary scenario of Cunoniaceae (p.p.) and presumed allies. Engler's tribes are encircled. (See Table 1 for the set of analyzed characters, including abbreviations.)

immediately obvious, although we regard the Brunelliaceae, Davidsoniaceae, and Eucryphiaceae to be close allies.

The two important synapomorphies that define the bulk of the Cunoniaceae are syncarpy and the possession of paired interpetiolar stipules that are entire from inception. Cuatrecasas (1970), Ehrendorfer (1977), and Ehrendorfer et al. (1984) argued that petals are a secondarily derived feature within the Cunoniaceae and Brunelliaceae, however, for reasons outlined by Dickison (1989), we believe that petals have been independently lost on multiple occasions in different generic groups. Apetaly may distin-

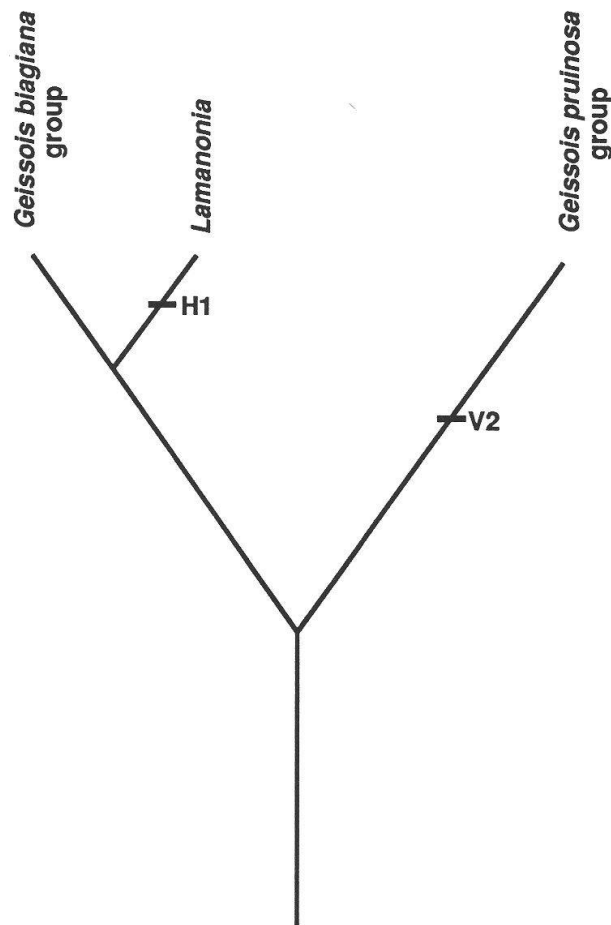

Fig. 53. Another evolutionary scenario of Engler's Belangereae. (Alternative to Fig. 52.)

guish an entire tribe or genus, as well as an isolated species within an otherwise petaliferous genus (*Ceratopetalum apetalum*). It has been hypothesized earlier by one of us (Dickison 1989) that the biovulate state is primitive. Species of the apocarpous genera *Acsmithia* and *Spiraeanthemum* are biovulate and a similar condition exists in the apocarpous Brunelliaceae. Reductions to a single ovule have occurred in the genus *Aistopetalum* and some species of *Acsmithia*, and, as seen in Fig. 52, increases in ovular number have taken place in different lineages. In addition, the primitive follicle and ventrally dehiscent capsule with winged seeds evolved into a more specialized indehiscent fruit with nonwinged seeds many times and in various ways along separate evolutionary lines. Other derived features that have evolved independently within different lineages include verticillate and simple leaves, split-lateral nodes, simple perforation plates, half-inferior ovaries, and unisexual flowers.

Engler's tribal characterizations and supposed generic relationships can now be critically evaluated and discussed. On the basis of available information, the Spiraeanthemeae are a heterogeneous aggregation. *Acsmithia* and *Spiraeanthemum* are set apart from all other members of the family by their retention of a decidedly primitive, essentially apocarpous gynoecium in combination with exclusively scalariform perforation plates. However, this generic pair also combine several prominent specializations, viz., loss of petals, interpetiolar stipules, leaves simple or unifoliolate, and in the case of

Acsmithia, verticillate leaves. Ovules are reduced in number to one per carpel in certain species of *Acsmithia*, and unisexual flowers occur in *Spiraeanthemum*. The relationships of *Aphanopetalum* remain unsettled, although the genus clearly does not belong in association with the above two genera. The genus diverges from normal Cunoniaceae in its scrambling, twining or climbing habit and unilacunar nodal anatomy. The very reduced, nonvascularized colleters in a stipular position are unlike the stipules in other family members. Whether these laterally positioned outgrowths are reduced (rudimentary) stipules is uncertain. As noted by Hoogland (1960) the only other cunoniaceous genus in which the sepals are enlarged in the fruit is *Ceratopetalum*, although in *Aphanopetalum* the sepals are not stellately spreading. Although stipular development and morphology in *Aistopetalum* was not examined, the genus possesses imparipinnate leaves that are associated with interpetiolar stipules having colleters, apetalous flowers, 4–6 carpellate gynoecium, a single ovule per locule, indehiscent fruit, and an advanced wood anatomy with vessel elements having mostly simple perforation plates – all pointing to a relationship with *Schizomeria* and *Ceratopetalum*.

The small tribes Pancherieae and Pulleae, as circumscribed by Engler, include plants with flowers clustered in spherical heads. Inflorescence type was questioned as a useful character to differentiate the Pancherieae by Dickison (1984), although the assemblage may well be a natural one, despite the fact that the component genera show considerable variation in wood structure, aestivation, perianth type, or fruit and seed type. *Pullea*, the sole genus of the Pulleae, combines an advanced reproductive morphology with a primitive xylem structure. Members of both tribes possess interpetiolar stipules.

The majority of cunoniaceous genera were included by Engler in the tribe Cunonieae. This is an ill-defined, paraphyletic aggregation, although certain subtribal relationships are recognizable. *Cunonia* and *Weinmannia* are very closely related and R. D. Hoogland (pers. comm.) has gone so far as to suggest combining the two taxa. The only apparently consistent differences between the two genera is that seeds of *Weinmannia* are always hirsute, whereas those of *Cunonia* are uniformly winged. However, as noted by Dickison (1984), since both character states currently exist in *Caldcluvia* sensu lato the strength of this distinction is weakened. The general similarity in phyllotaxy and stipular morphology between *Cunonia* and species of *Pancheria* was noted by Rutishauser and Dickison (1989). *Ceratopetalum* and *Schizomeria* are clearly sister taxa, with both genera characterized by forked petals, a more advanced wood anatomy with some occasional, simple perforation plates, indehiscent fruit, and the specialized feature of morphologically similar, vertically oriented secreting ribs (adnate colleters) on the stipules. Simple or unifoliolate leaves occur in *Schizomeria* and certain species of *Ceratopetalum* (*C. apetalum*, *C. macrophyllum*).

Caldcluvia, in the broad sense of Hoogland (1979), is an anatomically and morphologically unnatural grouping. Hoogland (1979) noted the strong similarities of the genus to the *Cunonia-Weinmannia* complex, and noted that the flowers and fruits of the component species are too much alike to merit recognition as separate genera (as interpreted by Engler). The diversity in wood and seed structure has already been discussed (Dickison 1980a, 1984). It is further significant in this connection that *Caldcluvia paniculata* from Chile possesses lateral stipules, whereas all species from the southwest Pacific have the more common condition of interpetiolar stipules. Either the condition of free stipules represents a reversion, or *C. paniculata* is quite unrelated to the other recognized species in the complex.

Pseudoweinmannia, referred by Engler to the tribe Cunonieae, is better positioned near *Geissois* and *Lamanonia* in the tribe Belangereae (Fig. 52). All three genera share the

features of numerous stamens, apetalous, a racemose inflorescence, digitate leaves often with stipels, and the fact that stipules are bifid in *Pseudoweinmannia* and the *G. biagiana* group. *Pseudoweinmannia* is uniquely characterized by xylem having exclusively simple perforation plates, seeds with specialized food bodies, and indehiscent fruit. When one further relates the manner of stipular development to Engler's tribe, Belangereae, an interesting pattern of relationships emerges (Fig. 53). On the basis of stipular initiation, two species complexes can be identified within *Geissois*. One group, represented by the New Caledonian species *G. pruinosa*, is characterized by stipules that arise as axillary outgrowths, and the other group, represented by the Australian species *G. biagiana*, is characterized by laterally positioned stipular primordia. This points to the fact that the Australian species of *Geissois* may be phylogenetically closer to the South American genus *Lamanonia* than to the New Caledonian and Fijian taxa of *Geissois*.

Bauera is a problematic genus consisting of 3 species of spreading shrubs in eastern Australia and Tasmania. Although the floral morphology and anatomy was carefully studied by Bense and Palser (1975) and Dickison (1975), the systematic relationships of the genus are still controversial. Airy Shaw (in Willis 1973) emphasized the isolation of the taxon and many authors have recognized the family Baueraceae (Lindley 1831, Hutchinson 1969, 1973, Thorne 1983, Takhtajan 1987). Bentham and Hooker (1862–1867), Engler (1928), Schulze-Menz (1963), and Dickison (1975) tentatively favored placing *Bauera* in the Saxifragaceae (s.l.) whereas Cronquist (1981), Bense and Palser (1975), and Hideux and Ferguson (1976) considered the genus to be part of the Cunoniaceae. The suggested lythraceous affinities were dispelled by Dickison (1975, 1980a). Vegetative anatomy supports the separation of *Bauera* from the Saxifragaceae and its inclusion in either the Cunoniaceae or its own family, *Baueraceae* (Hils 1989). This conclusion is also in agreement with chemical evidence (Jay 1968).

Flowers of *Bauera* are actinomorphic and characterized by a polyandrous androecium. *B. rubioides* shows the highest stamen numbers (over 20), whereas the other two species possess fewer stamens, although always more than the number of petals (e.g., Co 8/A 12 in *B. sessiliflora*, Dickison 1975, Fig. 17). In all three species there is apparently no constant correlation between the members of the perianth and the androecium, neither positionally nor numerically. The stamens of *Bauera* appear to be equally spaced around the gynoecium, without showing a preference for either sepal or petal radii (see Bense & Palser 1975, Dickison 1975, Dickison & Rutishauser [unpublished results]). This independence in stamen positioning is obviously correlated with the early outgrowth of a homogeneous androecial rim (girdling primordium) inside the petal primordia as shown by SEM studies. On the rim all individual stamen primordia arise at about the same time. There is no first set of stamen primordia arising in the gaps between the young petals. In older developmental stages all stamen primordia are already initiated; they are about the same size, and are arranged in 2–3 rows (Dickison & Rutishauser unpublished results). Meanwhile, the gynoecium has also been initiated as a slightly two-lobed cup.

The occurrence of a meristematic rim as a common primordium for all stamens and the independence of stamen position and number with respect to the perianth may be features that should be considered in the search for the relatives of *Bauera*. The Cunoniaceae have one tribe (the Belangereae) with multistaminal androecia, although this complex is uniformly apetalous. As noted previously, acceptance of the evidence presented herein that the lateral appendages adjacent to the leaves in *Bauera* are best interpreted as stipules places the genus close to the Cunoniaceae. On the basis of pollen morphology Hideux and Ferguson (1976) suggested that both *Bauera* and *Eucryphia* should be included in the Cunoniaceae near the *Geissois* complex, although they also

observed that whereas syncolpate pollen are generally not encountered in the Cunoniaceae they are characteristic of *Bauera*.

The Brunelliaceae are a small family (one genus and 62 species) exhibiting a primitive apocarpous gynoecium and imparipinnately compound leaves with associated independent lateral stipules. Engler (1928) related the family to the Cunoniaceae by reason of the occasional verticillate leaves and associated lateral stipules, and the splitting of the pericarp into an inner sclerenchymatous endocarp and outer exocarp. The epitropous ovules of *Brunellia* were used by Engler as the principal character separating the family from the Cunoniaceae. A close relationship between Brunelliaceae and Cunoniaceae is indicated. The outstanding question is whether *Brunellia* deserves familial recognition or is better treated as a member of the Cunoniaceae. *Brunellia* is described as uniquely characterized by a linear sutural stigma and a highly specialized carpel maturation and fruit (Cuatrecasas 1970, 1985). However, a conspicuously elongate, decurrent stigma covers the ventral surface of the style in *Vesselowskya* (see Dickison 1989), and, given the diversity of fruit types within the Cunoniaceae, the fruit morphology of *Brunellia*, although uniquely specialized, seems less significant as the sole distinguishing character. The combination of apocarpy and lateral stipules places *Brunellia* in a basal position within the assemblage.

The collection of materials used in this study was made possible, in part, by a grant from the United States National Science Foundation awarded to W. C. Dickison. We are grateful to Drs. Peter K. Endress (Zürich), R. D. Hoogland (Paris), and H. Schneider (Basel), for making available liquid-preserved specimens utilized in this investigation. We also wish to thank Mrs. Suzan Sizemore (Chapel Hill), Ms. A. D. Calamba (Montreal) and Mr. U. Jauch (Zürich) for their technical assistance.

References

- Bange G. G. J. 1952. A new family of dicotyledons: Davidsoniaceae. *Blumea* 7: 293–296.
- Beadle N. C. W., Evans O. D. and Carolin R. C. 1972. *Flora of the Sydney region*. Sydney: Reed.
- Bensel C. R. and Palser B. F. 1975. Floral anatomy of the Saxifragaceae sensu lato. IV. Baueroideae and Conclusion. *Amer. J. Bot.* 62: 688–694.
- Bentham G. and Hooker J. D. 1862–1867. *Genera plantarum*. London: Reeve.
- Cronquist A. 1981. *An integrated system of classification of flowering plants*. New York: Columbia Univ. Press.
- Cuatrecasas J. 1970. Brunelliaceae. *Flora Neotropica* 2: 1–189.
- Cuatrecasas J. 1985. Brunelliaceae. *Flora Neotropica* 2, (Supplement): 28–103.
- Dickison W. C. 1975. Floral morphology and anatomy of *Bauera*. *Phytomorphology* 25: 69–75.
- Dickison W. C. 1980a. Comparative wood anatomy and evolution of the Cunoniaceae. *Allertonia* 2: 281–321.
- Dickison W. C. 1980b. Diverse nodal anatomy of the Cunoniaceae. *Amer. J. Bot.* 67: 975–981.
- Dickison W. C. 1984. Fruits and seeds of the Cunoniaceae. *J. Arnold Arb.* 65: 149–190.
- Dickison W. C. 1989. Comparisons of primitive Rosidae and Hamamelidae. In: Crane P. R. and Blackmore S. (eds.), *Evolution, systematics and fossil history of the Hamamelidae*, Vol. 1, pp. 47–73. Oxford Univ. Press.
- Ehrendorfer F. 1977. New ideas about the early differentiation of angiosperms. *Plant Syst. Evol.*, Supplement 1: 227–234.
- Ehrendorfer F., Morawetz F. and Dawe J. 1984. The neotropical angiosperm families Brunelliaceae and Caryocaraceae: First karyosystematical data and affinities. *Plant Syst. Evol.* 145: 183–191.
- Engler A. 1928. Cunoniaceae. In: Engler A. and Prantl K. (eds.), *Die natürlichen Pflanzenfamilien*. Band 2/18a: 229–262. Leipzig: W. Engelmann.

- Forman L. L. 1964. *Trigonobalanus*, a new genus of Fagaceae, with notes on the classification of the family. Kew Bull. 17: 381–396.
- Hideux M. J. and Ferguson I. K. 1976. The stereostructure of the exine and its evolutionary significance in Saxifragaceae sensu lato. In: Ferguson I. K. and Mueller J. (eds.), The evolutionary significance of the exine, pp. 327–377. Linnean Soc. Symposium Series 1.
- Hils M. H. 1989. Anatomy, morphology, and systematics of *Bauera* Banks. Amer. J. Bot. 76 (Supplement): 246.
- Hoogland R. D. 1960. Studies in the Cunoniaceae. I. The genera *Ceratopetalum*, *Gillbeea*, *Aistopetalum*, and *Calycomis*. Aust. J. Bot. 8: 318–341.
- Hoogland R. D. 1979. Studies in the Cunoniaceae. II. The genera *Caldcluvia*, *Pullea*, *Acsmithia*, and *Spiraeanthemum*. Blumea 25: 481–505.
- Hutchinson J. 1969. Evolution and phylogeny of flowering plants. Dicotyledons: Facts and theory. New York: Academic Press.
- Hutchinson J. 1973. The families of flowering plants. 3rd ed. Oxford: Clarendon.
- Jay M. 1968. Distribution des flavonoïdes chez les Cunoniacées. Taxon 17: 489–495.
- Kalkman C. 1988. The phylogeny of the Rosaceae. Bot. J. Linn. Soc. 98: 37–59.
- Lindley J. 1831. An introduction to the natural system of botany. New York: Carvill.
- Melville R. 1972. On the nature of the bud scale in the Cunoniaceae. Kew Bull. 26: 477–485.
- Rutishauser R. 1984. Blattquirle, Stipeln und Kolleteren bei den Rubieae (Rubiaceae) im Vergleich mit anderen Angiospermen. Beitr. Biol. Pflanzen 59: 375–424.
- Rutishauser R. and Sattler R. 1986. Architecture and development of the phyllode – stipule whorls of *Acacia longipedunculata*: controversial interpretations and continuum approach. Can. J. Bot. 64: 1987–2019.
- Rutishauser R. and Dickison W. C. 1989. Developmental morphology of stipules and systematics of the Cunoniaceae and presumed allies. I. Taxa with interpetiolar stipules. Bot. Helv. 99: 147–169.
- Schrödinger R. 1927. Die Stipeln der Cunoniaceen. Verh. Zool. Bot. Ges. Wien 77: 5–38.
- Schulze-Menz G. K. 1964. Saxifragaceae. In: Melchior A. (ed.), Engler's Syllabus der Pflanzenfamilien, 12. Aufl., S. 201–206. Berlin: Borntraeger.
- Sinnott E. W. 1914. Investigations on the phylogeny of the angiosperms. I. The anatomy of the node as an aid in the classification of angiosperms. Amer. J. Bot. 1: 303–322.
- Smith A. C. 1985. Flora vitiensis nova. Vol. 3. Honolulu, Pacific Tropical Bot. Gard.
- Takhtajan A. L. 1987. Systema magnoliophytorium. Leningrad, Officina editorial "Nauka".
- Thorne R. F. 1983. Proposed new realignments in the angiosperms. Nordic J. Bot. 3: 85–117.
- Troll W. 1939. Vergleichende Morphologie der höheren Pflanzen. 1. Vegetationsorgane. Band 2. Berlin: Borntraeger.
- Velenosky J. 1913. Vergleichende Morphologie der Pflanzen. IV. Teil. Prag: Rivnac.
- Weberling F. 1976. Weitere Untersuchungen zur Morphologie des Unterblattes bei den Dikotylen. IX. Saxifragaceae s.l., Brunelliaceae und Bruniaceae. Beitr. Biol. Pflanzen 52: 163–181.
- Willis J. C. 1973. A dictionary of the flowering plants and ferns (revised by H. K. Airy Shaw). 8th ed. Cambridge: University Press.