

# The pre Late Ordovician metamorphic evolution of the Gotthard-Tavetsch massifs (Central Alps) : from lawsonite to kyanite eclogites to granulite retrogression

Autor(en): **Biino, Giuseppe G.**

Objektyp: **Article**

Zeitschrift: **Schweizerische mineralogische und petrographische Mitteilungen  
= Bulletin suisse de minéralogie et pétrographie**

Band (Jahr): **74 (1994)**

Heft 1

PDF erstellt am: **23.09.2024**

Persistenter Link: <https://doi.org/10.5169/seals-56333>

## **Nutzungsbedingungen**

Die ETH-Bibliothek ist Anbieterin der digitalisierten Zeitschriften. Sie besitzt keine Urheberrechte an den Inhalten der Zeitschriften. Die Rechte liegen in der Regel bei den Herausgebern.

Die auf der Plattform e-periodica veröffentlichten Dokumente stehen für nicht-kommerzielle Zwecke in Lehre und Forschung sowie für die private Nutzung frei zur Verfügung. Einzelne Dateien oder Ausdrucke aus diesem Angebot können zusammen mit diesen Nutzungsbedingungen und den korrekten Herkunftsbezeichnungen weitergegeben werden.

Das Veröffentlichen von Bildern in Print- und Online-Publikationen ist nur mit vorheriger Genehmigung der Rechteinhaber erlaubt. Die systematische Speicherung von Teilen des elektronischen Angebots auf anderen Servern bedarf ebenfalls des schriftlichen Einverständnisses der Rechteinhaber.

## **Haftungsausschluss**

Alle Angaben erfolgen ohne Gewähr für Vollständigkeit oder Richtigkeit. Es wird keine Haftung übernommen für Schäden durch die Verwendung von Informationen aus diesem Online-Angebot oder durch das Fehlen von Informationen. Dies gilt auch für Inhalte Dritter, die über dieses Angebot zugänglich sind.

## The pre Late Ordovician metamorphic evolution of the Gotthard-Tavetsch massifs (Central Alps): from lawsonite to kyanite eclogites to granulite retrogression

*Dedicated to the memory of Ugo Pognante, Torino 1954 – Mont Blanc du Tacul 1992.*

by *Giuseppe G. Biino*<sup>1</sup>

### Abstract

This study provides regional and thin section scale evidence for a multi-stage metamorphic history in the Gotthard and Tavetsch massifs. Textural and structural observations yield information on the relative timing of metamorphic mineral growth and recrystallization. They provide a basis for assessing the significance of P-T data acquired from petrologic calculations. Coronas are often excluded by petrologists in order to define P or T, but this paper shows evidence for equilibrium between mineral phases in such domains. Similarly, pseudomorphs are not usually included in quantitative P-T calculations. Yet, possible chemical compositions are postulated here on theoretical grounds, and the sensitivity of the constrained P-T-X conditions on such model compositions is evaluated by performing calculations for different compositions.

The most important information on the first metamorphic (eclogite facies) event is preserved in mafic rocks, but field evidence (intrusive contacts between eclogitized metagabbros and paragneisses) strongly suggest that the whole sequence underwent high-pressure metamorphism. An early high-pressure assemblage includes lawsonite as a key mineral phase. The estimated temperature for this event is below 600 °C. Lawsonite was subsequently replaced by a higher temperature eclogite assemblage (in the range of 650–700 °C). A down-P, up-T or isobaric heating (ca. 50 °C) path lead to the formation of the eclogitic temperature peak assemblage. The stable assemblage at peak temperature is Grt-Omp-Ky-Otz-Zo-Hbl-Ilm-Mt-Py-Rt. Estimated temperatures and minimum pressures are 700–750 °C and 1.8 GPa, respectively, at this stage, which is attributed to a subduction event. The dehydration of sediments in the oceanic slab produced hydration in the overlying underplated terrane, causing the formation of hornblende. The eclogite rocks preserve rather unique evidence for the T-prograde evolution (pre-relaxed stage of the thermal evolution). The observed prograde path provides an important link between blueschist and high temperature eclogite events. The subsequent granulite facies event is characterized by Grt-Di-Opx-Olig-Qtz-Hbl-Ilm-Mt-Py-Ttn. This assemblage is observed only at the local equilibrium (cm) scale and yields temperatures ranging from 600 to 700 °C at a pressure of approximately 0.8 GPa. Advection of the isotherms during rapid uplift was responsible for the granulite event. Subsequent uplift and cooling were accompanied by hydration and partial melting of the metasediments. The minimum age of the migmatitic overprinting is constrained by the post-orogenic intrusion of granitoids dated at  $\approx$  440 Ma. The resulting path reflects the style and rate of unroofing.

In terms of regional geology this investigation shows many new features and defines more clearly the importance of the already documented granulite event. The presented quantitative results are important in order to understand isotope geochemistry and the Late Ordovician magmatism, and they constrain the thermo-tectonic evolution of the region. It is concluded that the old geodynamic models considering the formation and closure of small intracratonic basins or neglecting the Caledonian event in the Alps have to be abandoned since they are inconsistent with the presented petrologic observations.

*Keywords:* eclogite facies, granulite facies, metamorphic petrology, geodynamic evolution, pre-Variscan orogeny, Central Alps.

---

<sup>1</sup> Mineralogisch-petrographisches Institut, Baltzerstrasse 1, CH–3012 Bern, Switzerland.

and

Institut de Minéralogie et de Pétrographie, Université de Fribourg, Pérolles, CH–1700 Fribourg, Switzerland.

## 1. Introduction

There is clear evidence in the Alpine belt for polycyclic evolution. In the Central Alps, the Alpine orogeny was responsible for deformation and metamorphism both of post-Variscan sedimentary and igneous sequences and of a pre-Mesozoic metamorphic basement. The pre-Mesozoic basement (as in a Chinese puzzle) shows Variscan magmatic and metamorphic events superimposed on an older already metamorphosed basement, on magmatic rocks and on a cover (MERCOLLI et al., 1994).

The Gotthard and Tavetsch massifs (the term "massif" is used in order to be consistent with the names occurring in the official maps of Switzerland) have a well documented low-grade (prograde from North to South) Alpine metamorphic evolution (NIGGLI, 1970; FREY et al., 1980; BAMBAUER and BERNOTAT, 1982; BERNOTAT and BAMBAUER, 1982; MERZ et al., 1989), and contain clear evidence of Variscan tectono-metamorphic events. In the Gotthard massif, the presence of pre-Variscan metamorphic relics was documented by ARNOLD (1970) and implicitly suggested by several earlier authors (e.g. AMBHÜL, 1929; WINTERHALTER, 1930; HUBER, 1943; NIGGLI, 1944). The occurrence of high-pressure metamorphic assemblages within the Gotthard and Tavetsch massifs has been reported only recently (GEBAUER et al., 1988; ABRECHT et al., 1991a), and a comprehensive description of their polymetamorphic evolution has not yet been given. Age, metamorphic grade and tectonic evolution of the pre-Variscan event(s) are still poorly known. In the following, the pre-Variscan event(s) are considered to be Caledonian in agreement with several radiometric data (GRAUERT and ARNOLD, 1968; ARNOLD, 1970; GEBAUER et al., 1988; GEBAUER, 1990; ABRECHT et al., 1991a; SCHALTEGGER, 1993, 1994; SERGEEV and STEIGER, 1993; OBERLI et al., 1993). The term Caledonian is used for the Lower Paleozoic orogenic event(s) that produced a diachronous mountain belt, the extension and complexity of which can be compared to the Alpidic belt. Remnants of Caledonian mountain belts are preserved on all the continents, and several local names are in use. The term Caledonian is used in order to be consistent with the term Alpidic (and also to preserve the traditional euro-centric view of the universe).

The present paper summarizes the first results of research (still in progress) done on a regional scale on the pre-Late Ordovician metamorphic evolution of the Gotthard and Tavetsch basements. Strong Variscan deformation and a pervasive metamorphic overprint make the reconstruc-

tion of the early evolution of the Helvetic basement difficult. Pre-Variscan minerals are hardly preserved. Details on the regional distribution, rock associations and parageneses observed in the mafic and ultramafic rocks of the Aar-Gotthard and Tavetsch massifs were reported by BIINO and ABRECHT (1994). A detailed description of the mineral and textural evolution of a metagabbro stock (Kastelhorn pluton) is given in a companion paper by ABRECHT and BIINO (1994). The present contribution describes the sequence of metamorphic associations that developed in protoliths composed originally of gabbro and basalt. Metamorphic rocks derived from these parent lithologies carry as a main first metamorphic product the eclogitic assemblage Grt-Omp-Qtz-AmI(a,b)-Rt (in N-MOR basalt) and Grt-Ky-Omp-Qtz-Zo-AmI-Rt (in metagabbro). The study of gabbroic lithologies is particularly helpful in constraining the eclogitic event since the gabbros are Al-rich and allow a more complex sequence of events to be recognized. A few samples show a prograde metamorphic evolution from lawsonite-bearing eclogite to Ky-Zo-Qtz eclogite (symbols for rock-forming minerals after KRETZ, 1983). In a subsequent event (Late Ordovician) the eclogitic assemblages broke down to form the classical granulite index minerals (Opx, Cpx, Pl, Grt). A later event yet is responsible for garnet amphibolite facies rocks.

Field and petrographical data suggest that the metasedimentary rocks are cofacial within the eclogite and granulite facies, and that the metamorphic evolution outlined above affected the whole basement.

## 2. Geological setting

The External Massifs of the Alps belong to the European domain (e.g. TRÜMPY, 1980; VON RAUMER et al., 1993). In the Central Alps, these massifs have been regarded as parautochthonous (i.e. nappes without imprimatur) units (PFIFFNER, 1986; ESCHER et al., 1987), and has been exposed by the Cenozoic Alpine denudation tectonic (TRÜMPY, 1969; PFIFFNER, 1986). The parautochthonous basement was subdivided into three main (Helvetic) basement units: Aar, Tavetsch, and Gotthard (Fig. 1).

The *Gotthard* is the southernmost Helvetic basement nappe. It measures approximately 70 km by 10 km and extends along the strike of the Alpine mountain belt. The pre-Variscan part of the Gotthard nappe is a composite basement formed by a polymetamorphic basement, Late Ordovician granitoids, and a cover (MERCOLLI et al.,

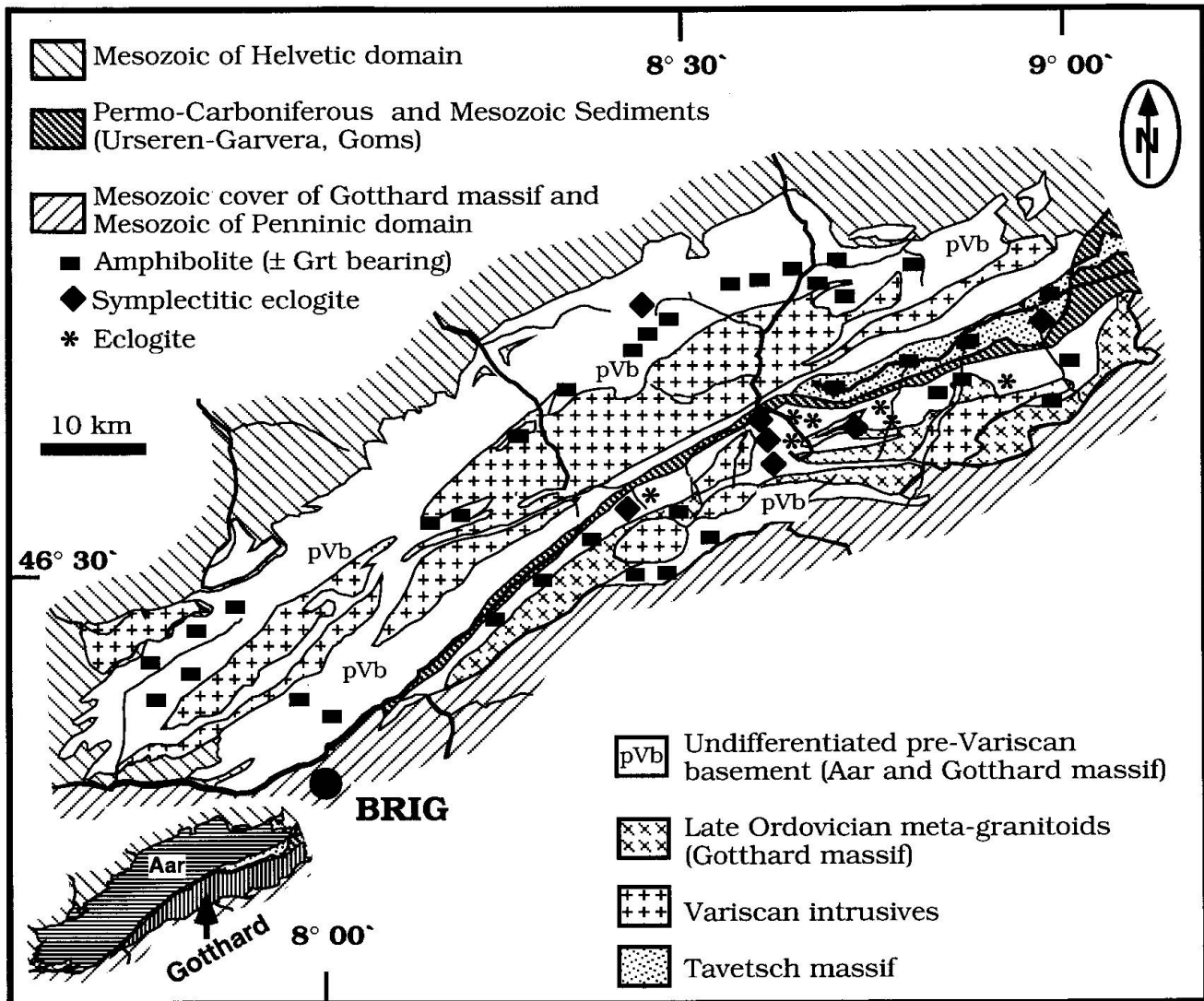

Fig. 1 Geological outline of the Aar-, Tavetsch- and Gotthard massifs; only the larger mafic lenses (or a group formed by several lenses) are shown. The oldest metamorphic assemblage still preserved is given. In all occurrences of eclogite or symplectitic eclogite, garnet-bearing amphibolite and amphibolite occur, too. Ultramafic rocks are also always associated with the mafic rocks.

1994). All of these were deformed and metamorphosed during the Variscan orogeny (TRÜMPY, 1980; VON RAUMER et al., 1993; MERCOLLI et al., 1994). The polymetamorphic basement is formed by metapsammite, metasemipelite and metapelite enclosing subordinate marble and mafic-ultramafic bodies of medium and high metamorphic grade (ABRECHT et al., 1991a; VON RAUMER et al., 1993; PFEIFER et al., 1993). The mafic-ultramafic rocks form two genetically and chronologically distinct groups (BIINO and MEISEL, 1993). The oldest group is made up of E- and N-MOR metabasalt and abyssal peridotite with minor metagabbro. This group is interpreted as an ophiolite sequence tectonically emplaced in an accretionary wedge (ABRECHT et al., 1991a; BIINO and MEISEL, 1993).

Metagabbro and cumulitic ultramafic make up the younger group (ABRECHT et al., 1991 a, 1991 b; ABRECHT and BIINO, 1994). Isotopic and geochemical data suggest that these younger metagabbros originated in an island arc (IA) environment. After the emplacement of the younger metagabbros the Gotthard basement was metamorphosed at eclogite- and then at granulite- and garnet amphibolite-facies conditions (ABRECHT et al., 1991 a, b). The migmatite event observed in the metasediments is younger than or coeval with the granulite event in the mafic rocks (ARNOLD, 1970; ABRECHT et al., 1991a; MERCOLLI et al., 1994). After the migmatitic event another deformation phase occurred, during which the mafic rocks recrystallized under garnet amphibolite facies.

Single-crystal U–Pb ages from abraded zircons in retrograded eclogitized IA gabbro yield ages of ca. 464 Ma (OBERLI et al., 1993, 1994). This age may be interpreted either as an intrusive or as a metamorphic age. In the first case, the magma intrusion, high-pressure metamorphism and subsequent uplift must have occurred within 30 Ma, since the whole sequence is cut by a Late Ordovician intrusive (SERGEEV and STEIGER, 1993). Alternatively, this age gives the time of metamorphic recrystallization. Regardless, the intervening time between magmatism and metamorphism was short because older components are not observed in the zircons. The latter scenario looks like the most probable.

GEBAUER (1990) and GEBAUER et al. (1988) investigated zircon grains with an ion probe from a garnet-bearing mafic rock collected in Val Nalps. The protolith of the mafic rocks is gabbroic, and this rock possibly underwent HP metamorphism, though no petrographic description of the rock was given by these authors. Zircons from this rock preserve ages from 460 Ma to 3.17 Ga. Gebauer suggested that the middle Riphean ages, measured for some of this zircons ( $\approx 870$  Ma), should be related to the emplacement of the magma and that the Ordovician age corresponds to the HP metamorphism.

The Gotthard basement was intruded (ABRECHT et al., 1991a; MERCOLLI et al., 1994) by Late Ordovician granitoids (ARNOLD, 1970; BOSSART et al., 1986; SERGEEV and STEIGER, 1993). The Late Ordovician granitoids show epiplutonic features, such as local porphyritic textures, sharp and discordant intrusive contacts, fine-grained marginal facies, pegmatite and aplite dikes. Aplite dikes from the Late Ordovician plutons cut the fold axis that folded the leucosomes in the paragneisses. The main lineation and the compositional banding formed during the garnet amphibolite event are cut discordantly by the Late Ordovician plutonic rocks. These plutons were strongly deformed by the main Variscan and possibly by a late Caledonian phase of deformation (syn-tectonic intrusives?).

The *Tavetsch* nappe forms a wedge shaped basement outcropping east of Andermatt (between Aar and Gotthard). In the following this nappe is considered as the intervening basement between Aar and Gotthard (i.e. including the Goms basement and other minor lenses of basement). The pre-Alpine evolution of the Tavetsch basement is poorly characterized due to its quaternary cover and a strong Alpine retrogression and deformation. According to NIGGLI (1944) it is possible to recognize several lithostratigraphic analogies between Gotthard and Tavetsch base-

ments. Recent investigations confirm the suggested analogies (ABRECHT et al., 1991a). BIINO (in prep.) suggested that the Tavetsch basement shared the major part of the pre-Alpine metamorphic evolution with the Gotthard basement. Therefore, the two basements are considered part of the same pre-Alpine unit. The name Gotthard and Tavetsch massifs refers to the Alpine structuration. During Alpine cycle the two units were clearly distinct. In order to avoid confusion, in the following the Gotthard and Tavetsch massifs (GTM) refers to a unique pre-Alpine terrain, and the post Caledonian evolution is not considered.

### 3. Petrography of the mafic rocks

#### 3.1. GENERAL REMARKS

Mafic and ultramafic bodies form several linear arrays concordant with the regional SW–NE foliation, in the GTM. The lenses and intrusive stocks are from a few meters to several hundred meters thick.

Garnet-bearing polymetamorphic mafic rock types outcrop both as fine- and coarse-grained rocks. The protolith of the fine-grained mafic rocks is probably a basalt. They are probably part of the sequence characterized by an oceanic affinity. Relics of magmatic textures suggest that the coarse-grained mafic rocks derived from gabbros (both with oceanic and island arc affinity).

Leucocratic veins and pods are commonly observed in association with the eclogitized metagabbros. They have preserved magmatic textures and structures. Similar rock types are observed in other high-pressure terrains (NICCOLET and LEYRELOUP, 1978; LEARDI et al., 1984; GODARD, 1988; KIÉNAST et al., 1991). These rock types may represent either leucocratic magmatic differentiates or products of partial melting of the Ky–Zo eclogites.

Several lenses of garnet-bearing polymetamorphic mafic rocks show eclogitic assemblages partially retrograded to symplectitic eclogite (Fig. 1). Mafic rocks without omphacite, but containing both Na–Di + Pl symplectites and the relic assemblage Grt + Rt + Qtz  $\pm$  Zo  $\pm$  Ky, are interpreted to represent altered eclogite (symplectite eclogite). Mafic rocks containing recrystallized symplectite are made up by Am + Pl, but contain relics of an older assemblage made up of Grt + Rt + Qtz + Zo + Ky are also considered to be altered eclogite (eclogitic amphibolite). These interpretations are based firstly on field observation (i.e. a

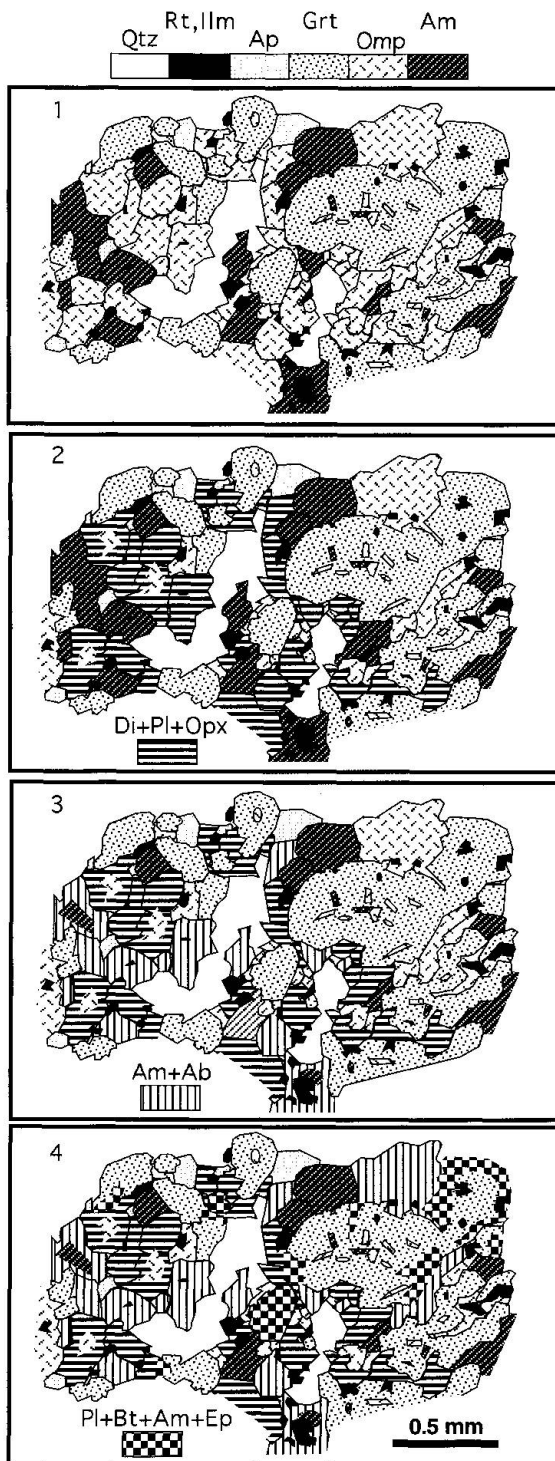

Fig. 2 Textural and mineralogical evolution of a fine grained eclogite step 4 was drawn from a photo (sample Vn3, Alpe Toma, Val Nalps) and steps 1, 2, and 3 are interpretation. The protolith is of N-MORB type affinity.

few cases where continuous transitions from eclogite to symplectite eclogite to eclogitic amphibolite was observed). Secondly, to this author's knowledge the assemblage  $\text{Grt} + \text{Rt} + \text{Qtz} + \text{Zo} +$

Ky is stable only under high-pressure conditions. The microstructural evolution of a fine-grained eclogite is proposed in figure 2. In the mafic xenoliths included in the Late Ordovician granites (BIINO and ABRECHT, 1994), only relics of garnet are preserved of the pre-Variscan mineral assemblages.

It is difficult to distinguish the Variscan from the Late Caledonian overprint, since both reached amphibolite facies conditions. Tentative criteria based on field observation are proposed by BIINO and ABRECHT (work in progress). According to these criteria the extensive amphibolitization and the regional foliation are considered to be Variscan. Metamorphic recrystallization in Late Variscan dikes and plutons helps in distinguishing the Alpine from the pre-Alpine events.

In the following sections the most important stages during both prograde and retrograde paths will be presented.

### 3.2. LAWSONITE BREAKDOWN DURING THE BURIAL PATH

Centimeter-long pseudomorphs of rhombic shape (Fig. 3a) characterize a Mg-rich metagabbro (sample FP53). This metagabbro is outcropping at Fuorcla da Paradis (Val Nalps) and was formed in contact with abyssal peridotites. In order to understand the rhombic pseudomorphs the entire textural and mineralogical evolution has to be considered.

Large parts of the rock matrix are made up of very pale, coarse-grained Hbl + Pl intergrowths (up to 0.5 millimeter). Locally, Hbl recrystallized in sub-millimeter idioblasts. These pseudomorphic textures are interpreted as replacement of magmatic mafic phases by Na-Am and Na-Cpx, analogies to the eclogite facies minerals described in the following.

Pseudomorphs of a few millimeters length are formed by  $\text{Pl} + \text{Zo} \pm \text{Qtz}$ . Zoisite forms characteristic spray or sheaf aggregates, and probably is a relic of the assemblage  $\text{Jd} + \text{Qtz} + \text{Zo}$ . Plagioclase makes up polycrystalline aggregates that include the zoisite crystals. Quartz is rare and forms drop-shaped blasts. The rim of the pseudomorphs is formed by a corona of polycrystalline plagioclase aggregates similar to those described from the Kastelhorn metagabbro (ABRECHT and BIINO, 1994). This pseudomorphic replacement is reminiscent of the breakdown of  $\text{Jd} + \text{Qtz} + \text{Zo}$  (after primary plagioclase) during amphibolite facies metamorphism (BIINO and COMPAGNONI, 1992).

Dodecahedral aggregates made up of  $\text{Pl} + \text{Bt} + \text{Am}$  are interpreted as former Grt.

Rhombic pseudomorphs are formed by a texturally homogeneous core and a thin corona aggregate (Fig. 3b). The cores of the pseudomorphs are made up of twinned Zo idiomorphs with minor and variable amount of Pg + Ms and seldom Rt. Kyanite blasts are very seldom observed in association with Zo. Zoisite blasts are rimmed by Czo. The external corona aggregate is formed by Pl + Pg + Ms ± Zo. The shape of the pseudomorphs, the inferred bulk composition and the product phases all suggest that Lw was the phase replaced. A prograde metamorphic reaction would have produced Zo ± Ky from Lw, and these products were then partially replaced by Czo and by Pg + Ms ± Pl. This evolution, suggested by microstructural observation, is also supported by thermobarometry and the inferred P-T path (see below).

The presence of pseudomorphs both after Lw and Pl in the same rock calls for an explanation. With increasing (water-) pressure, plagioclase breaks down following the continuous reaction



which renders the Pl composition to more and more albitic. At higher pressure the Ab-rich plagioclase also breaks down, and the discontinuous reaction

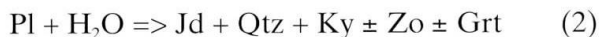

takes place according to the scheme proposed by FYFE et al. (1978, pag. 134).

Pseudomorphs formed by Zo ± Qtz, and rimmed by Pg + Ms ± Pl, are observed in the mafic rocks outcropping at the Grossmutterhorn (Furkapass area), Alpe Toma (Val Nalps), Piz Senderi (Val Lavaz) and Gurschen (Andermatt area; ABRECHT and BIINO, 1994). The symplectitic intergrowth of Qtz + Zo (or Czo) is very fine grained (1–2 μm wide) and probably replaced Lw. The pseudomorphs are deformed, though in the above localities there is no evidence for a syn- or post-eclogite deformation phase. This suggests that a phase of deformation occurred between Lw breakdown and the peak temperature of the eclogite recrystallization phase.

### 3.3. THE HIGH-PRESSURE CLIMAX

The prograde metamorphic evolution resulted in the formation of high-pressure high temperature assemblages. The eclogites outcrop in an area of hundreds of km<sup>2</sup>, and the definition of an eclogite belt is justified in the author's view (Fig. 1).

The eclogitic mineral assemblage is made up by Grt-Omp-Qtz-AmI-Rt (in the N-MOR basalt)

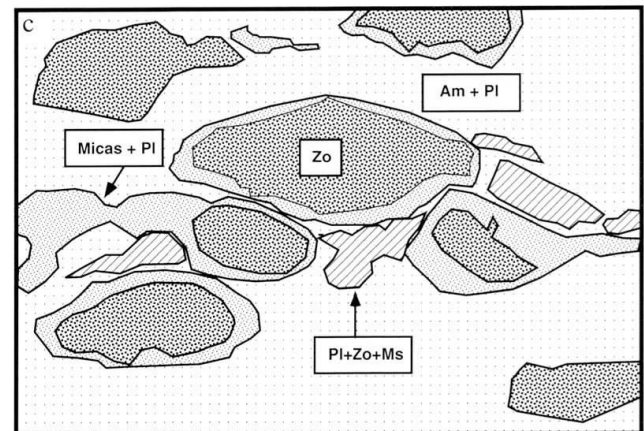
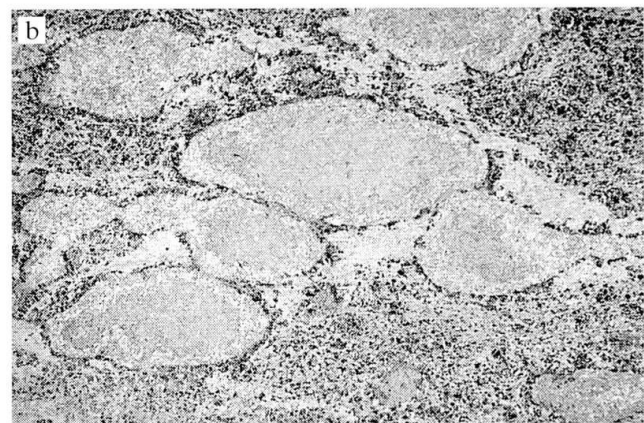
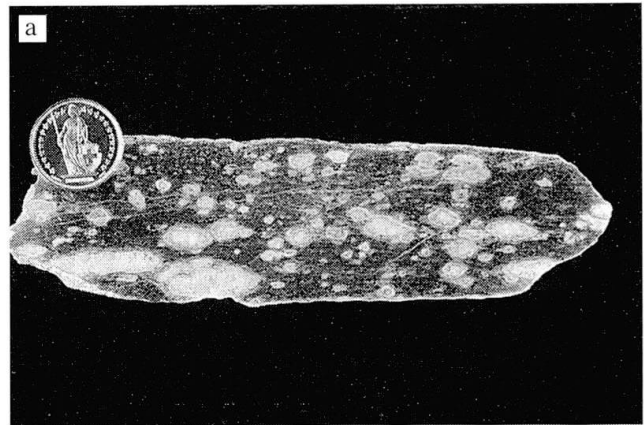

Fig. 3 a: Deformed rhombic pseudomorphs after lawsonite (sample FP53, Metamagnesian gabbro from Fuorcla da Paradis, Val Nalps; scale: coin  $\varnothing \approx 2.3$  cm). b: Zoisite aggregate makes up the core of the rhombic pseudomorphs. White micas, Pl and Zo make up the rim (detail from the same sample; scale: longer side of the photo is 2.0 cm).

and Grt-Ky-Omp-Qtz-Zo-AmI-Rt (in the IA metagabbro). Qtz-Ky-Zo eclogite is seldom described in crustal sequences, and this assemblage represents a high temperature eclogite facies overprint.

Solid inclusions in garnet (Omp, Zo, Am Ia, Qtz, Rt) are concentrated mainly in the core. In

coronitic metagabbro, Ky inclusions in garnet show an asymmetric distribution, being concentrated in proximity of magmatic plagioclase sites. Kyanite is mainly acicular in the core and idiomorphic in the rim of garnet.

In metagabbro, the rare Bt flakes were replaced by Ms + Grt + Rt.

A brown-green amphibole (Am Ia: Mg-hornblende, ferrian Mg-hornblende and ferri-subcalcic Mg-hornblende) formed during the eclogite event. A younger, randomly oriented, dark green amphibole generation (Am Ib: Mg-hornblende, ferrian barroisite and edenite, all of them with  $\text{TiO}_2 > 1.3 \text{ wt}\%$ ) partially replaced omphacite. Am Ib possibly grew while temperature increased during the high-pressure event (see below).

Rutile defines fine-grained clouds, preserving the shape of an elongate Ti-rich Cpx or Am. Rutile is also present in the eclogite matrix where it forms small disseminated grains associated with ilmenite and pyrite. Zircon usually has xenomorphic shapes in fine grained eclogite, but is idiomorphic in the metagabbro. In the metagabbro outcropping at Zignau (Rheintal) two different types of zircons are observed. Those included in garnet are idiomorphic, whereas zircons are rounded in the rock matrix (OBERLI et al., work in progress).

The absence of complete high-pressure assemblages in the metasediments is not surprising, owing to their higher susceptibility to deformation and fluid availability from internal reactions. However, kyanite (ARNOLD, 1970) and coronitic garnet + muscovite around biotite are observed in the paragneiss of Val Nalps. Primary contacts between metagabbros in eclogite facies and meta-

sediments (Unteralptal, N-W of the Kastelhorn) also suggest that the country rocks underwent high-pressure conditions and did not come into contact with the eclogite much later at some shallower depths.

#### 3.4. OMPHACITE BREAKDOWN DURING UNROOFING

During uplift, Omp was partially replaced by two different symplectite types. One type is made up of Na-Di + Olig (Fig. 4; Olig = oligoclase), the other type of Am II + Olig. Am II also forms coaxial rims around Am Ib crystals (Am II: Mg hornblende and edenitic hornblende, all of these have  $\text{TiO}_2 < 1.3 \text{ wt}\%$ ). Both types of symplectite grew with complex random- or dendritic-like patterns on Omp (sieve symplectite). Omphacite is usually fringed by growing inwards from the margin allotriomorphic symplectitic intergrowth (concave towards the omphacite). Even where Omp is no longer present, symplectite intergrowth has inherited the texture of eclogitic rocks, and former grain boundaries are still recognizable. Recrystallization (globularization after JOANNY et al., 1991) of the symplectite and coarsening (bordering of the lamellae after JOANNY et al., 1991) are locally observed. The Am- and Di-bearing symplectites are in textural equilibrium. Whether the formation of the two different types of symplectites was controlled by the availability of fluid or by different intensive parameters will be addressed in a forthcoming contribution. The volume fraction of Pl and Na-Di in the symplectite has been defined by electron microscope image processing. It turns out that the Omp breakdown was isochemical with the exception for silica,



The classical evolution of the symplectites toward a crypto-crystalline felt (aphyric-brownish matrix under the microscope), as usually described in B-type eclogite (BOLAND and VAN ROERMUND, 1983; GODARD, 1988; KIÉNAST et al., 1991) has not been observed here.

#### 3.5. THE GRANULITE EVENT

The eclogite assemblage is replaced by a garnet granulite assemblage (Grt + Na-Di + Opx + Olig + Am II + Qtz + Ilm + Rt).

In the fine grained eclogites Opx ( $\text{En}_{50}\text{Fe}_{50}$ ) usually forms a continuous monomineralic corona around Qtz. This corona is transitional to an ex-

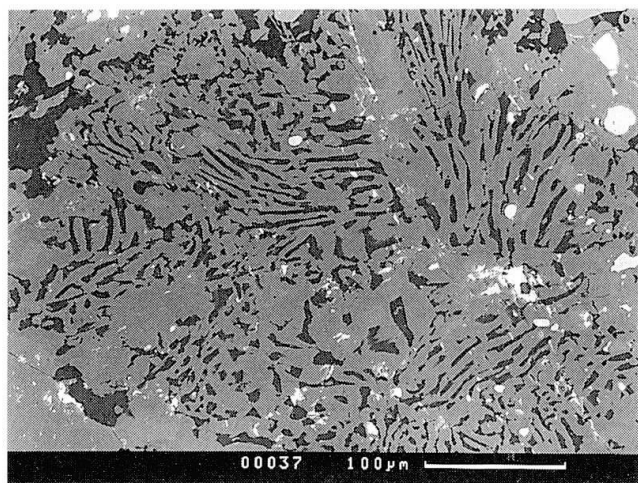

Fig. 4 Back-scattered electron (BSE) image of sodic diopside (up to 15 mole % of Jd; pale gray) and oligoclase ( $\text{Ab}_{90}\text{An}_{10}$ – $\text{Ab}_{80}\text{An}_{20}$ ; black) symplectite after omphacite (sample Ua36, Unteralptal).



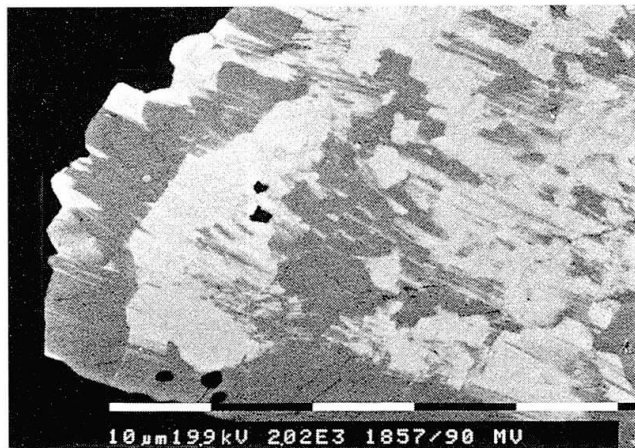

Fig. 5 Back-scattered electron image of orthopyroxene (En<sub>50</sub>Fs<sub>50</sub>; in white) and diopside (dark gray) intergrowth. Quartz is black (sample Vn3).

ternal rim made up by two pyroxenes ± Olig. Locally the two pyroxenes form lamellar intergrowths (Fig. 5). Opx possibly formed according to the reaction



In addition to the corona structures, Opx occurs in granoblastic textures in metasediments and metagabbros from Val Nalps (ARNOLD, 1970; BIINO, in prep.). Characteristic pseudomorphs after Opx were also observed by ABRECHT and BIINO (1994) in a few samples from the Kastelhorn metagabbro. At the regional scale, the granulite event is poorly constrained because Opx was typically replaced by amphibole. Only three Grt-bearing amphibolites (out of approximately one thousand investigated) still preserve Opx.

The garnet granulite assemblage is replaced by a Di + Ab + Am III ± Opx assemblage (Am III: ferroan pargasitic hornblende and pargasitic hornblende). The breakdown of Na-rich diopside started at the contact with Qtz. Plagioclase of the symplectite changed composition from Olig to Ab. The following reactions possibly occurred at this stage of the metamorphic evolution:

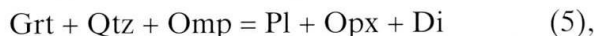

Granulite assemblages were then replaced to garnet amphibolite assemblages, consisting of Grt + green Hbl + Ab/Olig. The two pyroxenes and the older amphibole are replaced by Am IV (Am IV: edenitic hornblende and Mg hornblende) or by Am IV + Olig ± Ep intergrowth. In the intergrowth amphibole forms needle-like idioblasts in clear textural contrast with the older symplectites (Fig. 6).

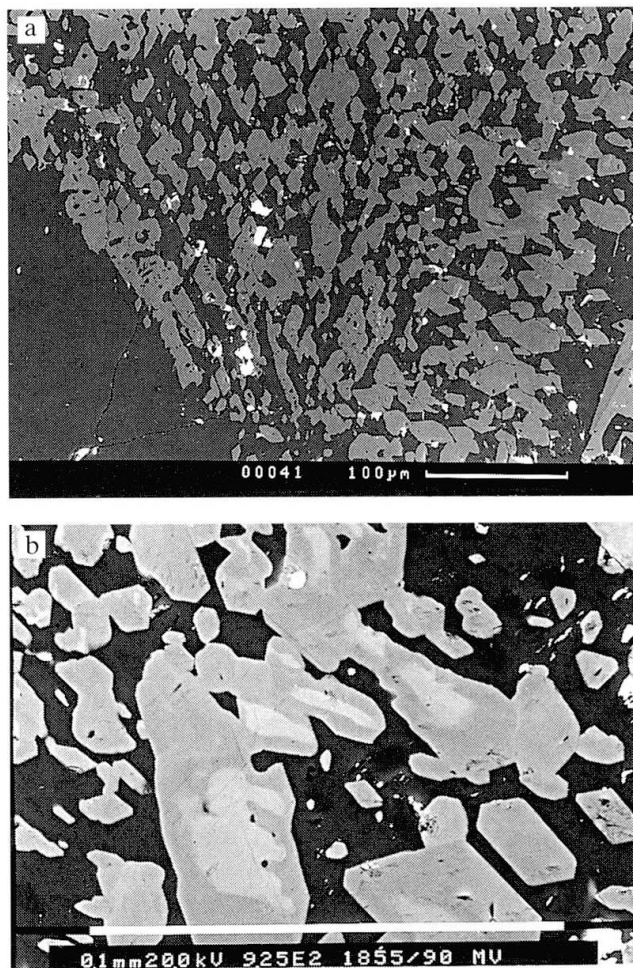
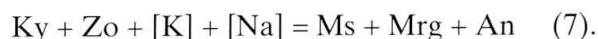

Fig. 6 a: Amphibole (Mg-hornblende and edenitic hornblende; gray) albite (black) intergrowth. b: Amphibole (Mg-hornblende and edenitic hornblende; gray) albite (black) intergrowth replacing diopside (pale gray cores in the Am) and oligoclase (not visible) symplectite after omphacite (BSE image; sample Vn10 from Alpe Toma, Val Nalps).

### 3.6. KYANITE AND HIGH-PRESSURE MUSCOVITE BREAKDOWN DURING UNROOFING

In the metagabbro matrix, Ky shows rims of micas + Pl, and Zo is corroded. The micas produced by decomposition of Ky and Zo are sodic margarite and muscovite solid solutions. The solubility between Ms and Pg is limited (up to 25 mol% Pg in Ms), but Mrg may contain up to 50 mol% of Pg (submicroscopic intergrowth cannot be excluded).

The corona formation strongly infer growth of micas at the expense of Ky according to an overall reaction of the following type:



It is proposed that the fluid phase carried [K] and [Na] (complexed with unknown chemical ele-

ments) to the reaction site, both Ms and Mrg include Pg in solid solution. A reaction such as (7) would have occurred after the granulite event, but before the intrusion of the Late Ordovician plutons (because in the paragneiss sillimanite formed during the migmatitic event; ARNOLD, 1970). Since the pressure was probably higher than 0.5 GPa, it is not possible to define the speciation and the dominant complexes. No attempt was made, therefore, to compute a proper mass balance calculation for reaction (7).

In the same rocks, fine grained biotite-plagioclase intergrowths are commonly observed and are interpreted to be pseudomorphs after phenitic muscovite (ABRECHT and BIINO, 1994). Microscopic observation suggests that mica breaks down by the reaction:

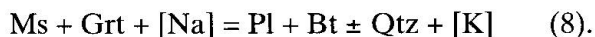

The mode fraction of biotite is significantly less than that of Ms, therefore [K] was transported away from the reaction site. Sodium was carried to the reaction site.

Replacement of Ky by Crn + Sp as in the eclogites of the Black Forest (KLEIN and WIMMENAUER, 1984) has not been observed here.

### 3.7. GARNET BREAKDOWN DURING COOLING

Green amphibole and biotite are common in the more retrograded parts of mafic lenses. These phases define either curved sub-millimeter thick planes (marking fluid infiltration paths?) or mesoscopically visible kelyphitic rims around Grt. In the mafic rocks, centimeter-size quartz veins only occur when completely amphibolitized. Mafic rocks with strong retrograde alteration and deformation show the development of a compositional banding, and a lineation is defined by amphibole. Metasomatic biotite rims are common along the contact of the mafic rocks with the gneisses (this process may be either Variscan or Late Caledonian).

Garnet is rimmed by a kelyphitic Am V richer in Al (Am V: alumino ferroan pargasitic hornblende, alumino ferro tschermakite). The kelyphitic Am V is zoned and shows a deeper greenish color at the contact with garnet (Fe-Al zoning), whereas at greater distance from garnet, Am is actinolitic hornblende or actinolite. Plagioclase + Ep + Bt also replaced Grt. Biotite grew in complete disequilibrium with Grt, as suggested by the Kd of the Fe-Mg exchange ( $T \approx 1000^\circ\text{C}$ ). Plagioclase is strongly zoned, changing from anorthite to andesine over a few microns.

Rutile and Ilm are rimmed by Ttn, but micro-

structural criteria do not allow to correlate this reaction to the previously described sequence of events. The high Al content in Ttn suggests a formation under still HP conditions (FRANZ and SPEAR, 1985).

In the Wittenwassertal, submillimeter size idiomorphic garnet formed at the expense of Pl + Ep + Bt (pseudomorphs after older garnet). The new generation of garnet may be considered either Alpine or Variscan, but lamprophyres from the same locality preserve a magmatic appearance and neither plagioclase nor biotite are recrystallized.

## 4. Phase relations

### 4.1. THEORETICAL ASSUMPTIONS AND METHODOLOGY

In polymetamorphic rocks the evaluation of the P-T conditions is hampered by the calibrations used for thermobarometry, and some segments of the P-T path may be artifacts of the thermodynamic inconsistencies between the different calibrations (e.g. different thermometers may yield a systematic shift, and hence the constrained path may show false segments). If furthermore, thermo-barometric calibrations are selected using arbitrary criteria (or the necessity to fit an author's prejudices), the approach leads to largely predetermined thermobarometric results without much meaning. The approach to consider all the possible calibrated thermobarometers (e.g. SCHULZ, 1993) is meaningless. The problem is approached using the UBC database (BERMAN, 1988; 1990; aragonite thermodynamic data after MÄDER and BERMAN, 1991). All possible equilibria are computed using the internally consistent set of thermodynamic data mentioned earlier and PTAX program (release 1991, University of Bern). Several aspects of this approach are still under scrutiny (e.g. HOLDAWAY and MUKHOPADHYAY, 1993), and erroneous activity-models may lead to unreal P-T conditions.

Before evaluating calculated P-T-X conditions, the sensitivity of the applied solution models should be considered. A problem of the database used is the absence of activity models for several of the considered phases. Omphacite activities are estimated assuming ideal molecular mixing between Di-Hed-Jd. This approach yields only approximate results. Several authors have shown that the Jd-Di solution is non-ideal (HOLLAND, 1990; with references therein), and Omph ( $\text{Jd}_{50}\text{Di}_{50}$ ) is an effective end-member that is structurally different from both Di and Jd (ROSSI, 1988); in the Gotthard-Tavetsch massifs, om-

phacite composition is variable since it is controlled by the availability of Na in the system. Garnet activities were calculated with the solution model proposed by BERMAN (1990). The uncertainties of the thermodynamic data and the activity-models for Zo and Pg are likely to influence the P-T-X estimates (see below). Amphiboles are not taken into account in the present contribution.

Since all of the metamorphic stages are preserved in the same outcrop or even in the same thin section, the relative sequence of events is based on microstructural observations. This helps to clarify the chronology of the metamorphic events, however, the obvious disequilibrium hampers the assessment of P-T values since it is not clear which of the coexisting phases reached equilibrium. In order to attack this problem, probe sections were subdivided into several reaction domains and metamorphic P-T conditions were calculated for each of these. Where texturally and mineralogically similar domains define similar P-T conditions, local equilibrium is assumed to have been reached and preserved. If thermobarometry yielded comparable results for one type of reaction domain, these P-T values were considered representative of specific metamorphic conditions. In this way, metamorphic paths were reconstructed from the different portions of the same rock. This approach is time consuming, but it may help to reduce possibility of P-T artifacts.

Three different approaches have been used in order to constrain the P-T-t path:

(i) The high-pressure event is constrained to a rather large field by presence/absence of key minerals. This is the classical approach developed by BOWEN (1940) and THOMPSON (1955), but the curves are calculated directly from the measured or inferred mineral compositions using an internally consistent database. The univariant equilibria constitute a useful first look at the metamorphic evolution of the investigated rocks, and serve to restrict the P-T-X field of the high-pressure metamorphism.

(ii) The trajectory in P-T space during the high-pressure event is constrained by the Cpx-Grt thermometry.

(iii) The granulite event is constrained by the approach of BERMAN (1991) applied with success by LIEBERMAN and PETRAKAKIS (1991).

#### 4.2. RESULTS

*The eclogite facies stage.* Metamorphic conditions during the eclogitic event were constrained by taking into account the mineral assemblages and the presence (or absence) of critical minerals

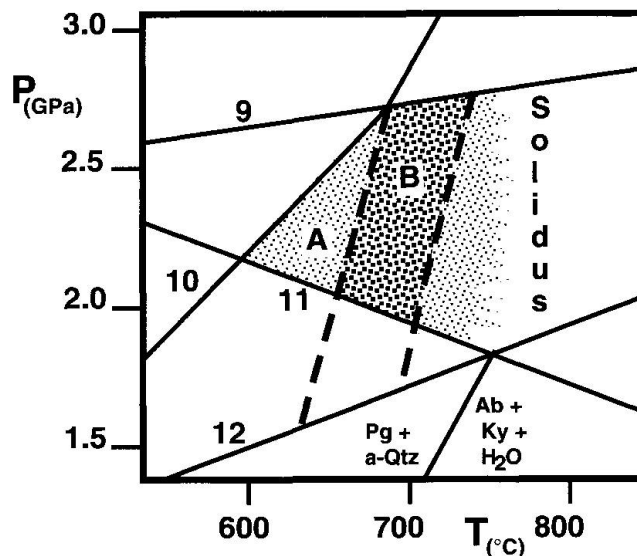
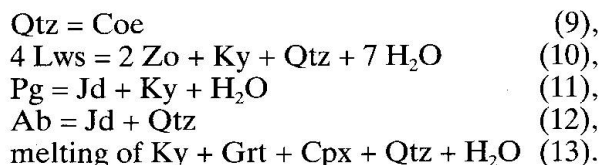

Fig. 7 P-T conditions defined for the high-pressure event (field A delimited by metamorphic reactions, the numbers correspond to the reaction numbers in the text). The two dashed lines, delimiting field B, correspond to the lower and higher temperature averages calculated for the Fe-Mg exchange between Cpx and Grt (samples collected in Unteralptal, Val Maighels and Val Nalps are considered).

(field A in Fig. 7). The following equilibria were computed:



Reactions (9)–(12) have been calculated using the database of BERMAN (release feb89.rgb) for the analyzed chemical compositions of mineral phases. Quartz, Ky, Coe and Zo were considered as pure end members. The Cpx rich in jadeite ( $\text{Jd}_{50}$ ) was used for the calculation of reactions (11) and (12). The composition of the Pl reacting with Cpx and Qtz (reaction 12) is unknown. A composition  $\text{Ab}_{80}\text{An}_{20}$  was chosen as a reasonable approximation for the P-T-X calculation. Indeed, there is microchemical and theoretical evidence that Olig is the highest-pressure plagioclase in equilibrium with Qtz and Jd (FYFE et al., 1978; RUBIE, 1990). In the literature there is evidence that under high-pressure conditions  $\text{Pg}_{90}\text{Ms}_{10}$  should be the most probable Pg composition. Paragonite was considered in terms of an ideal solid solution between Ms and Pg. An activity of 0.90 was used for the calculation. One effect of reducing  $\alpha(\text{Pg})$  is to shift reaction (11) to higher temperatures, an effect that turns out to be particularly pronounced at low pressure (Tab. 1). Reac-

Tab. 1 Reaction  $Pg = Cpx + Ky + H_2O$  (reaction 11 in the text) computed for different activities of paragonite, using different routines for the equation of state. The activities for Cpx and Ky are equal to 0.5 and 1.0, respectively. The reported values are rounded to the next multiple of 5.

H <sub>2</sub> O routine after KERRICK and JACOBS (1981)			
activity	2.5 GPa	2.0 GPa	1.5 GPa
$\alpha_{(Pg)} = 1.0$	450 °C	690 °C	905 °C
$\alpha_{(Pg)} = 0.9$	485 °C	730 °C	950 °C
H <sub>2</sub> O routine after HAAR et al. (1984)			
activity	2.5 GPa	2.0 GPa	1.5 GPa
$\alpha_{(Pg)} = 1.0$	410 °C	635 °C	840 °C
$\alpha_{(Pg)} = 0.9$	440 °C	665 °C	885 °C
H <sub>2</sub> O routine after HOLLAND and POWELL (1991)			
activity	2.5 GPa	2.0 GPa	1.5 GPa
$\alpha_{(Pg)} = 1.0$	425 °C	650 °C	870 °C
$\alpha_{(Pg)} = 0.9$	450 °C	690 °C	915 °C

tion (13) is after GREEN (1982). The eclogitic assemblages correspond to pressures greater than 1.8 GPa (assuming  $\alpha(H_2O) = 1$ ) at a temperature of approximately 600–750 °C. However, a lower H<sub>2</sub>O activity expands the stability field of the eclogitic assemblages to lower pressures. Reaction (12) is independent of  $\alpha(H_2O)$  and constrains both the minimum pressure to 1.6 GPa. Reactions (11) and (12) constrain the maximum possible  $\alpha(CO_2)$  to approximately 0.25 at 705 °C and 1.7 GPa. Better constraints on fluid composition are provided by the eclogitic assemblage observed in the metagabbros (see below). Ideal mixing is considered for Zo in the following, a sufficient approximation here because the analyzed Zo are close to end-member composition. The location of reaction (10) in P-T-X space is a function of three variables ( $\alpha_{Lw}$ ,  $\alpha_{Zo}$  and  $\alpha_{H_2O}$ ), but reaction (10) reached completion, and Cpx-Grt thermometry defines temperatures higher than maximum Lw stability field.

Temperature estimates using Cpx-Grt thermometry (Fe–Mg exchange) are consistent with the P-T field constrained by phase relations, and help to reduce the T field for eclogite recrystallization (field B, Fig. 7). Cpx-Grt thermometry was applied by using near rim analyses from two different microstructural domains, the first of which is formed by Omp included in Grt. These pairs yield temperatures of ca. 650–700 °C. The second microstructural domain is formed by Omp dispersed in the rock matrix, but in contact with Grt. The latter Cpx-Grt pairs indicate that a down-P up-T (700–750 °C), or isobaric heating (ca. 50 °C)

path occurred during the eclogite facies event. During the heating event the pressure path is not well constrained since the eclogite assemblages are not sufficiently sensitive to pressure changes, but the eclogites were still in the kyanite stability field (field B, Fig. 7). The calculated difference in temperature between the two sites is large enough to separate the two steps.

*The unroofing path.* High pressure and high temperature retrogression is suggested by the presence of coarse-grained Na-Di-Olig symplectite after Omp. The jadeite content of the Cpx (10% of Jd molecule; Cpx is stable with Pl and Qtz) constrains the pressure to 1.0–0.8 GPa (at temperatures between 700 and 600 °C). Activity coefficients for Ab-rich plagioclase and Na-bearing Di are inadequately known, and this pressure estimate should be considered with caution.

The application of the Cpx-Pl thermobarometer (JOANNY et al., 1991) to Pl-Di symplectites yields suspiciously high temperatures ( $\approx 800$  °C). These authors concluded that lamellar width is much more sensitive to temperature than to time. Therefore, they did not consider the kinetics of the process. In the author's view, symplectite formation depends strongly on kinetics. Recrystallization of the symplectite in the eclogites from the Gotthard-Tavetsch massifs did not produce changes in chemical composition of Na-Di or Pl. This suggests that the recrystallization occurred under P-T conditions similar to those of the earlier symplectite formation. The widespread retrogression and the absence of crypto-crystalline symplectite after Omp cannot be compared to that of other high-pressure terrains with similar P-T paths (e.g. Brossasco Isasca unit KIÉNAŠT et al., 1991). A reason for the absence of crypto-crystalline symplectite and the surprisingly high (apparent) temperatures may be the longer persistence of high temperature conditions or larger fluid availability.

The granulite facies event is observed only in microdomains of a few centimeters size. Orthopyroxene is in apparent equilibrium with Grt, Cpx, Pl and Qtz. This mineral association defines granulitic conditions. Calculation of several of the possible equilibria involving minerals of the granulite metamorphic paragenesis yields (exchange equilibrium) temperatures ranging from 600 to 700 °C and pressures of approximately 0.8 GPa (Fig. 8). The convergence of all the mineral equilibria in one relatively small volume of the P-T-X space may be used to argue that the Gibbs free energy minimum was reached, because the close spacing of the equilibria in a thermodynamically consistent approach is not considered to be an artifact of the data calculations. This result suggests that the granulite assemblage represents a

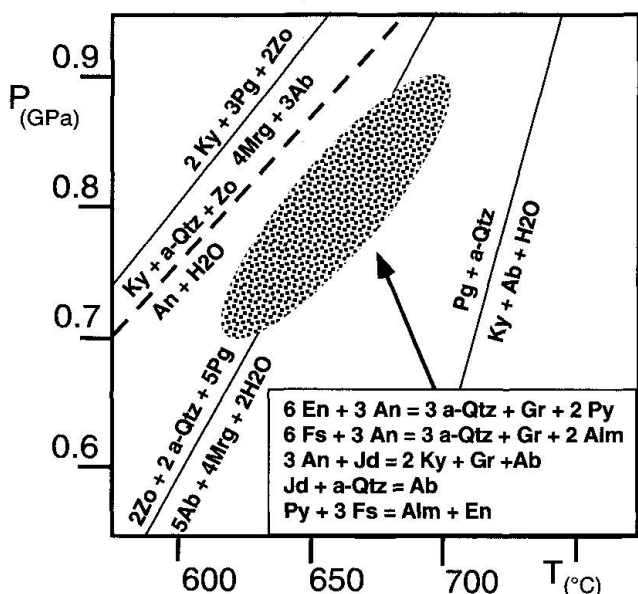

Fig. 8 P-T conditions defined for the granulite event (see text for explanations). The elliptical field corresponds to the intersections of the equilibria reported in the inset, but a statistical distribution of the intersections inside the field is not considered (sample Vn3; calculated from analysed compositions of the solid phases).

real metamorphic event and is not a product of disequilibrium.

It is not clear when Rt, Ilm and Ttn formed. They have low modal abundance and, based on relative diffusivities and small size, these phases most likely were modified by retrograde reactions. For all of these reasons they are excluded from the evaluation of the P-T conditions.

The inferred P-T conditions suggest that both the high-pressure event and the isothermal uplift occurred close to the onset of melting for fluid-saturated basic rocks. At high-pressure the fluid-present solidus curve for basaltic rocks is rather insensitive to fluid composition. In the field, evidence for melt formation was ambiguous. Leucocratic pods in the metagabbros may be either primary differentiated magma phases or partial melts. Apatite (of several millimeters length) rimmed by garnet and the presence of primary Pl-Am-Bt suggest that these pods are low pressure magmatic rocks (ABRECHT and BIINO, 1994). Nevertheless, the absence of melting in high temperature and high-pressure terranes still remains a puzzling problem.

The lower stability for Zo + Ky is approximately 0.8–1.0 GPa in the temperature range considered. In figure 8 the reaction

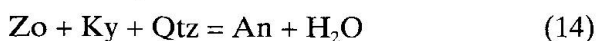

is computed for pure phases. The curve shifts to significantly lower temperatures (and higher

pressures) with decreasing An activity (Tab. 2). Reaction (7) cannot be easily computed, but the reaction

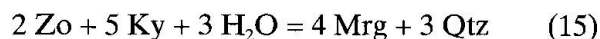

may give a safer indication on the Zo + Ky breakdown. Considering activities equal to one for all the phases, reaction (15) occurs at P and T conditions corresponding to the end of the granulite event (700 °C, 0.67 GPa; 600 °C, 0.83 GPa), but this reaction is very sensitive to Mrg activities. Assuming ideal mixing between Pg and Mrg, the analyzed Mrg compositions are responsible for a shift in the equilibrium to approximately 1.3 GPa (in the temperatures range of 600 to 700 °C).

The conditions computed for reactions (14) and (15) suggest that in mafic rocks the Zo + Ky breakdown occurred at the beginning of the granulite event, probably in association with the Omp breakdown.

## 5. Fluid composition during the high-pressure event

The question of whether or not a free fluid phase is present during high-pressure metamorphism has received considerable attention in the past. The definition of the aqueous speciation, the effect of electrolytes and aqueous complexes and their thermodynamic data are unknown under high-pressure conditions. Therefore, a crude simplification of the problem is necessary. In the following, the fluid phase is considered to consist of CO<sub>2</sub> and H<sub>2</sub>O only. At the temperatures of interest, CO<sub>2</sub>-H<sub>2</sub>O mixing has been considered ideal (see LABOTKA, 1991). Non-ideality is present at lower temperatures and should have an effect at higher temperature, but the experimental and theoretical data presently are insufficient (MÄDER, 1991). The effects of uncertainties in solution models are evaluated by calculating the relevant reactions with several different solution models.

In high-pressure rocks of similar setting (HOLLAND, 1979; JAMTVEIT et al., 1990) there are several examples in which the heterogenous phase equilibrium (11) and

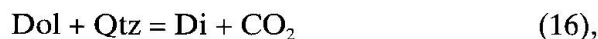

(observed in mafic and carbonate-bearing rocks, respectively) were used in order to constrain the fluid phase composition during high-pressure events. The resulting two divariant surfaces define a univariant curve in P-T-X space, and fluid composition is confined to a small range.

Tab. 2 Reaction  $Zo + Ky + Qtz = An + H_2O$  (reaction 14 in the text). The reported values are rounded to the next multiple of 5.

0.8 GPa	$\alpha_{(An)} = 1.00$	$\alpha_{(An)} = 0.80$	$\alpha_{(An)} = 0.60$ ;
	T = 620 °C	T = 585 °C	T = 545 °C
1.0 GPa	$\alpha_{(An)} = 1.00$	$\alpha_{(An)} = 0.80$	$\alpha_{(An)} = 0.60$ ;
	T = 710 °C	T = 670 °C	T = 625 °C

This approach is not exactly correct. In a system governed by local equilibrium the fluid-rock reactions are faster than transport, i.e. the chemical reactions are considered instantaneous, and transport is the factor controlling the evolution of the system. A fluid percolating through two different rock types has a constant composition only in the case where the down-flow rock type or both rock-types define an indifferent state system with the fluid. It follows that the mineral assemblages buffer the fluid composition or part of it, and the fluid in contact with the carbonate-bearing rock has a composition that does not necessarily correspond to that of the fluid in the carbonate-free assemblage.

The composition of the eclogite-forming fluid can be estimated from heterogeneous phase equilibria occurring in each rock type. The high-pressure assemblage in the metagabbros constrains the maximum amount of  $CO_2$  in the fluid based on the following reactions:

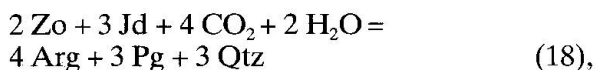
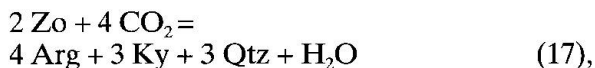

combined with reactions (9), (10), (11) and (12).

At equilibrium, the activity of  $H_2O$  is constrained by the mineral assemblage to a small P-T-X field (Fig. 9). The equilibrium  $Ab = Jd + Qtz$  is independent of fluid composition and constrains the maximum activity of  $CO_2$  by intersection with reactions (17) and (11) (Fig. 9). The intersection of four surfaces representing reactions (10), (11), (17) and (18) (all dependent on fluid composition) limit the maximum activity of  $CO_2$  at low temperatures (Fig. 9). The presence of  $Ky + Zo$  suggests a relatively low  $X_{CO_2}$  in the metamorphic fluid ( $X_{CO_2} < 0.25$ ). Close to the high-pressure limit the activity of  $CO_2$  is even lower ( $X_{CO_2} < 0.04$ ). The Fe-Mg exchange between Cpx-Grt defines P-T conditions that are consistent with the constructed P-T-X space and helps to reduce the possible P-T-X space. Eclogite assemblage formation is thus estimated to have occurred under conditions of low  $X_{CO_2}$ .

In the absence of direct calibrations of the reactions considered and despite experimental inconsistencies (reviewed by MÄDER, 1991) computed phase relations are used to explore the P-T-X uncertainties. BRODHOLT and WOOD (1993) suggested that  $H_2O$  under high-pressure is less compressible than predicted by the HAAR et al. (1984) equation of state. The standard state thermodynamic data in the database produced by BERMAN and coworkers were retrieved using the HAAR et al. (1984) equation of state. Calculation of the mineral reactions using other equations of state obviously introduces discrepancies in the location of the calculated equilibria and between calculated and experimental curves, too. In order to evaluate the influence of the models on the P-T-X estimate, reaction (11) was computed assuming constant activities for all the phases except  $H_2O$ . Volumetric properties of water were calculated both with a modified Redlich-Kwong equation of state (KERRICK and JACOBS, 1981 and with equations of HOLLAND and POWELL, 1990, 1991; and HAAR et al. (1984). The maximum temperature difference between the models is ~ 60 °C at the given pressures (Tab. 1) and decreases toward both lower and higher pressures, but HOLLAND and POWELL (1990, 1991) and the HAAR et al. (1984) equations give comparable results. Reaction (17) was also computed in this way. The differences are significant, but the HAAR et al. (1984) equation shifts the equilibrium far away from the other the two models (Tab. 3). The KERRICK and JACOBS (1981) and HOLLAND and POWELL (1990, 1991) equations plot the equilibrium at too high a temperature (otherwise Arg should be stable). The influence of Zo activities on reaction (17) was tested for a range of activities (from  $\alpha_{zo} = 1.0$  to  $\alpha_{zo} = 0.8$ ). The shift of the curve location in the P-T-X space is negligible, and the thermodynamic properties of the fluid phase have a more important effect (Tab. 3).

The inferred results are considerably influenced by the proposed solution models and equation of states, and a precise definition of the P-T-X conditions is not possible. The high-pressure fluid phase (already simplified to only two components) introduces a degree in complexity that should suggest caution before reaching conclusions concerning equilibria between solid and fluid phases.

## 6. The P-T path and geological consequences

The proposed P-T-t path is affected by uncertainties due to analytical errors, errors in solution models and errors in the standard state thermody-

<b>1-2-3-4</b>	$\text{Coe} = \text{a-Qtz}$
<b>6-7-8-9-10</b>	$\text{Pg} = \text{Jd} + \text{Ky} + \text{H}_2\text{O}$

<b>1-4-8-7-5</b>	$2 \text{Zo} + 4 \text{CO}_2 = 4 \text{Arg} + 3 \text{Ky} + 3 \text{a-Qtz} + \text{H}_2\text{O}$
<b>5-6-7</b>	$\text{Ab} = \text{Jd} + \text{a-Qtz}$
<b>8-7</b>	$2 \text{Zo} + 3 \text{Jd} + 2 \text{H}_2\text{O} + 4 \text{CO}_2 = 4 \text{Arg} + 3 \text{Pg} + 3 \text{a-Qtz}$

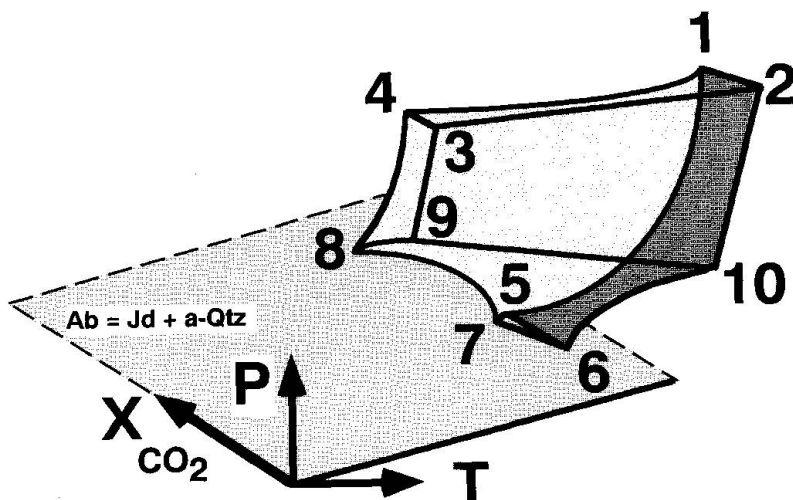

	<b>T °C</b>	<b>P GPa</b>	<b>X</b>
<b>1</b>	730	2.74	0.03 <sub>6</sub>
<b>2</b>	730	2.74	0.00 <sub>0</sub>
<b>3</b>	670	2.70	0.00 <sub>0</sub>
<b>4</b>	670	2.70	0.02 <sub>8</sub>
<b>5</b>	705	1.70	0.25 <sub>0</sub>

	<b>T °C</b>	<b>P GPa</b>	<b>X</b>
<b>6</b>	705	1.70	0.16 <sub>0</sub>
<b>7</b>	703	1.69	0.24 <sub>0</sub>
<b>8</b>	650	1.97	0.09 <sub>3</sub>
<b>9</b>	655	2.01	0.00 <sub>0</sub>
<b>10</b>	710	1.95	0.00 <sub>0</sub>

Fig. 9 P-T-X CO<sub>2</sub> diagram for the eclogite assemblage observed in the Ky-Zo-bearing eclogites.

namic data, but a P-T-t trajectory can reasonably be reconstructed for the GTM. The path is an estimate of burial and unroofing processes and appears compatible with present geological knowledge (Fig. 10). The resulting P-T-t path imposes important constraints on the thermal structure of the lithosphere and the geodynamic evolution of Central Europe.

The only constraint on the burial path are given by the prograde pseudomorphs after lawsonite. They suggest that the pressure peak was approached with a positive dP/dT slope. As in other high-pressure terranes this slope is  $\approx 300\text{--}350 \text{ }^\circ\text{C/GPa}$ . Zo-Ky-Qtz eclogites represent the

high-pressure high-temperature assemblage. Most probably the dehydrating sediments in the subducted oceanic slab caused hydration in the eclogites. Helium isotopes (work in progress) exclude the possibility that mantle fluid flow was responsible for the formation of Am Ia,Ib.

The increase in temperature during the eclogite event suggests the end of the subduction phase, followed by thermal relaxation. Increasing temperatures during eclogitic metamorphism have also been documented in the Silvretta nappe (MAGGETTI and GALETTI, 1988) and in Western Norway (JAMTVEIT, 1987). The subsequent heating probably caused a gravity instability that may

Tab. 3 Reaction  $2\text{Zo} + 4\text{CO}_2 = 4\text{Arg} + 3\text{Ky} + 3\text{Qtz} + \text{H}_2\text{O}$  (reaction 17 in the text) computed for different activities of zoisite, using different routines for the equation of state and fluid mixing models. The activities for all the other solid phases are equal to 1.0. The mole fraction of  $\text{H}_2\text{O}$  is equal to 0.90 and the mole fraction of  $\text{CO}_2$  is equal to 0.10 (these values are arbitrary, but consistent with the estimated fluid composition). The reported values are rounded to the next multiple of 5.

H <sub>2</sub> O, CO <sub>2</sub> and mixing model routines after KERRICK and JACOBS (1981)				
activity	2.5 GPa	2.0 GPa	1.5 GPa	
$\alpha_{(\text{zo})} = 1.0$	830 °C	735 °C	645 °C	
H <sub>2</sub> O after HAAR et al. (1984), CO <sub>2</sub> calculated for a modified Redlich-Kwong equation for ideal mixing of H <sub>2</sub> O- CO <sub>2</sub>				
activity	2.5 GPa	2.0 GPa	1.5 GPa	
$\alpha_{(\text{zo})} = 1.0$	770 °C	660 °C	560 °C	
H <sub>2</sub> O, CO <sub>2</sub> and mixing model routine after HOLLAND and POWELL (1991)				
activity	2.5 GPa	2.0 GPa	1.5 GPa	
$\alpha_{(\text{zo})} = 1.0$	820 °C	745 °C	670 °C	
H <sub>2</sub> O, CO <sub>2</sub> and mixing model routines after KERRICK and JACOBS (1981)				
activity	2.5 GPa	2.0 GPa	1.5 GPa	
$\alpha_{(\text{zo})} = 0.9$	825 °C	725 °C	640 °C	
$\alpha_{(\text{zo})} = 0.8$	820 °C	720 °C	635 °C	
H <sub>2</sub> O after HAAR et al. (1984), CO <sub>2</sub> calculated for a modified Redlich-Kwong equation for ideal mixing of H <sub>2</sub> O- CO <sub>2</sub>				
activity	2.5 GPa	2.0 GPa	1.5 GPa	
$\alpha_{(\text{zo})} = 0.9$	765 °C	655 °C	550 °C	
$\alpha_{(\text{zo})} = 0.8$	760 °C	655 °C	545 °C	
H <sub>2</sub> O, CO <sub>2</sub> and mixing model routine after HOLLAND and POWELL (1991)				
activity	2.5 GPa	2.0 GPa	1.5 GPa	
$\alpha_{(\text{zo})} = 0.9$	810 °C	740 °C	665 °C	
$\alpha_{(\text{zo})} = 0.8$	805 °C	730 °C	660 °C	

have contributed to decompression of the Gotthard-Tavetsch massifs (GTM). The calculated P-T conditions quantify the unroofing trajectory. Pressure dropped by approximately 1.0 GPa along a quasi-isothermal path, therefore the unroofing was rapid and tectonic processes are believed responsible for. The granulite event may have been driven substantially by advective heat generated by rapid uplift of the root of the collisional belt.

The P-T conditions prevailing during the granulite re-equilibration went far towards re-

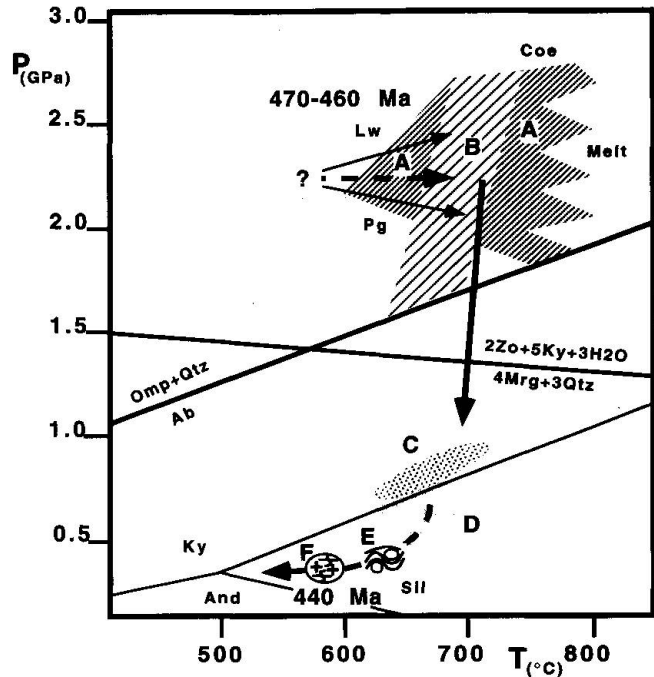

Fig. 10 P-T-t path of the Gotthard-Tavetsch massifs. The granulite facies and migmatitic event are marked by the letters C and D, respectively. The garnet amphibolite facies deformation event is evidenced by E and the Late Ordovician intrusions by F. The last two events may be in part coeval. The ages are from OBERLI et al. (1993 a, b) and SERGEEV and STEIGER (1993).

establishing a stable geothermal gradient. The thermal instability suggests that the post granulite unroofing occurred at the end of the same orogenic cycle. Nevertheless, the fact that in general equilibrium was reached during the granulite event suggest a temporary halt of the GTM in the lower crust. The granulite event was coeval with or was followed by migmatization of the metasediments. There is evidence that the partial melting occurred in the high-pressure part of the sillimanite field, since both sillimanite and kyanite are described in migmatitic gneiss (ARNOLD, 1970). The unusual presence of kyanite in migmatitic gneiss supports the proposed evolution. After solidification the leucosomes were folded (garnet amphibolite facies conditions in the mafic rocks), and crosscut by the Late Ordovician granitoids, i.e. the intrusives are partially coeval with this phase of deformation.

Thermal, tectonic and petrogenetic processes are obviously aspects of the same geological event. The presence of magmatism of supra-subduction (island arc) affinity and the described in-situ middle- to high-temperature eclogites suggest that a rather large ocean was consumed. This conclusion is in contradiction with several geodynamic models (VON RAUMER and NEUBAUER, 1993



with references therein) that consider opening and closure of intracratonic sedimentary basins and/or small intervening oceanic basins.

## 7. Conclusion

Mafic rocks occurring in the Helvetic basement are useful tools in the reconstruction of the geodynamic evolution of this part of the European basement. The evidence discussed above strongly suggest that it is possible to distinguish several metamorphic events in the pre-Late Ordovician history of the GTM. The strong retrograde overprinting does not prevent the precise definition of the regional P-T gradients during burial and subsequent unroofing. Initial subduction is responsible for the formation of Lw-bearing eclogite. Thermal relaxation produced middle- (to high-) temperature eclogites. Rapid uplift generated the granulite recrystallization and possibly caused partial melting of the metasediments. Equilibrium was achieved during the granulite event at scales smaller than few centimeters. Therefore, P-T conditions were derived only from phase composition measured at reaction sites. Deformation in the garnet amphibolite facies also occurred during the Ordovician, and orthogneiss intrusion (ca. 440 Ma) concluded the metamorphic cycle.

Blueschists and high-temperature eclogitic terrains have long been considered related to different tectonic setting (COLEMAN et al., 1965; SMULIKOWSKI, 1968). The evolution documented here suggests that a continuous burial path linked the two terranes. In several basements high-pressure granulite relics ( $P \approx 0.8\text{--}1.1$  GPa;  $T \approx 650\text{--}850$  °C) are commonly observed as witnesses of the oldest metamorphic event. The tectonic process responsible for such a metamorphism is still puzzling, and the metamorphic evolution of the GTM may suggest only one of the possible scenarios.

The integration of traditional field and microstructural observations with modern petrologic techniques allowed to reconstruct the P-T-t path of this metamorphic terrane. The applied technique looks quite promising in order to understand complex polymetamorphic evolutions. This approach offers a fundamental advantage over the traditional approach, because the agreement observed in the P-T-X conditions defined by different microstructural assemblages cannot be related to the thermodynamic data, but to the presence of equilibrium between the phase. The fast and easy method available for P-T-X grid calculations makes it possible to test the inferred mineral compositions. Therefore pseudomorphs may help to reduce the P-T-X field of equilibration.

## Acknowledgements

The critical reading and comments by J. Abrecht, Ch. De Capitani, M. Engi, M. Frey, F. Oberli, J. Selverstone, A. Stahel and three years of discussions at the MPIUNIBE with M. Bucher, A. Feenstra, K. Graf, B. Kamber, D. Kurz, J. Lieberman, I. Mercolli improved significantly this report. Ch. De Capitani remembered me that a consistent thermodynamic database solves conflicts for thermodynamic data of pure end-members, but activity models for solid solutions are not necessary consistent for different assemblages. The Schweiz. Nationalfonds supported the microprobe Cameca SX 50 (grant 21.26579.89) and the author (grant 20.29901.90).

## References

- ABRECHT, J., BIINO, G.G., MERCOLLI, I. and STILLE, P. (1991a): Mafic-ultramafic rock associations in the Aar, Gotthard and Tavetsch massifs of the Helvetic domain in Central Swiss Alps: markers of ophiolitic pre-Variscan sutures, reworked by polymetamorphic events? *Schweiz. Mineral. Petrogr. Mitt.* 71, 295–300.
- ABRECHT, J., BIINO, G.G., MERCOLLI, I. and STILLE, P. (1991b): Multireaction path of the coronitic Kastelhorn gabbro in the Gotthard Massif (Helvetic domain, Central Switzerland). *Terra abstracts* 3, 97.
- ABRECHT, J. and BIINO, G.G. (1994): The metagabbros of the Kastelhorn area (Gotthard massif, Switzerland): Their metamorphic history inferred from mineralogy and texture. *Schweiz. Mineral. Petrogr. Mitt.* 74, 51–66.
- AMBÜHL, E. (1929): Petrographisch-geologische Untersuchung im zentralen Gotthardmassiv südlich Andermatt. *Schweiz. Mineral. Petrogr. Mitt.* 9, 265–441.
- ARNOLD, A. (1970): Die Gesteine der Region Nalps-Curnera im nordöstlichen Gotthardmassiv, ihre Metamorphose und ihre Kalksilikatfels-Einschlüsse (Petrographische Untersuchungen im Bereich der Anlagen der Kraftwerke Vorderrhein). *Beitr. Geol. Karte Schweiz N.F.* 138. Lfg., 128 p.
- BAMBAUER, H.U. and BERNOTAT, W.H. (1982): The Microcline/Sandine Transformation Isograde in Metamorphic Regions. I. Composition and structural state of alkali feldspars from granitoid rocks of two N-S traverses across the Aar Massif and Gotthard "Massif", Swiss Alps. *Schweiz. Mineral. Petrogr. Mitt.* 62, 185–230.
- BERMAN, R.G. (1988): Internally-consistent thermodynamic data for stoichiometric minerals in the system  $\text{Na}_2\text{O-K}_2\text{O-CaO-MgO-FeO-Fe}_2\text{O}_3\text{-Al}_2\text{O}_3\text{-SiO}_2\text{-TiO}_2\text{-H}_2\text{O-CO}_2$ . *J. Petrology* 29, 445–522.
- BERMAN, R.G. (1990): Mixing properties of Ca-Mg-Fe-Mn garnets. *Am. Mineral.* 75, 328–344.
- BERMAN, R.G. (1991): Thermobarometry using multi-equilibrium calculations: a new technique, with petrological applications. *Can. Mineral.* 29, 833–855.
- BERNOTAT, W.H. and BAMBAUER, H.U. (1982): The Microcline/Sandine Transformation Isograde in Metamorphic Regions. II. The region of Lepontine metamorphism, Central Swiss Alps. *Schweiz. Mineral. Petrogr. Mitt.* 62, 231–244.
- BIINO, G.G. and COMPAGNONI, R. (1992): Very high-pressure metamorphism of the Brossasco metagranite, southern Dora-Maira Massif, Western Alps. *Schweiz. Mineral. Petrogr. Mitt.* 72, 347–362.

- BIINO, G.G. and MEISEL, T. (1993): Geochemistry of polymetamorphic ultramafics (major, trace, noble and rare earth elements): an example from the Helvetic basement (Central Alps, Switzerland). *Mineralogy and Petrology* 49, 189–212.
- BOLAND, J.N. and VAN ROERMUND, H.L.M. (1983): Mechanisms of exsolution in omphacites from high temperature, type B, eclogites. *Phys. Chem. Miner.* 9, 30–37.
- BOSSART, P.J., MEIER, M., OBERLI, F. and STEIGER, R.H. (1986): Morphology versus U–Pb systematics in zircon: a high-resolution isotopic study of a zircon population from a Variscan dike in the Central Alps. *Earth and Planetary Science Letters* 78, 339–354.
- BOWEN, N.L. (1940): Progressive metamorphism of silicious limestone and dolomite. *J. Geol.* 48, 225–272.
- BRODHOLT, J. and WOOD, B. (1993): New high pressure experiments on the volume of water using synthetic fluid inclusions. *Terra Abstracts* 5, 485.
- COLEMAN, R.G., LEE, D.E., BEATTY, L.B. and BRANNOCK, W.W. (1965): Eclogites and eclogites: their differences and similarities. *Geol. Soc. Amer. Bull.* 76, 483–508.
- ESCHER, A., MASSON, H. and STECK, A. (1987): Coupes géologiques des Alpes occidentales suisses. *Rapp. géol. Serv. Hydrol. et géol. natl.* 2, 1–11.
- FRANZ, G. and SPEAR, F.S. (1985): Aluminous titanite (sphene) from the eclogite zone, south-central Tauern Window, Austria. *Chem. Geol.* 50, 33–46.
- FREY, M., BUCHER, K. and MULLIS, J. (1980): Alpine metamorphism along the Geotraverse Basel–Chiasso – a review. *Eclogae geol. Helv.* 73, 527–546.
- FYFE, W.S., PRICE, N.J. and THOMPSON, A.B. (1978): Fluids in the crust. In: *Development in geochemistry*. Elsevier, Amsterdam, 1, 383 pp.
- GEBAUER, D. (1990): Isotopic systems – geochronology of eclogites. In: D.A. CARSWELL (ed.): *Eclogite facies rocks*. Blakie, New York, 141–159.
- GEBAUER, D., VON QUADT, A., COMPSTON, W., WILLIAMS, I.S. and GRÜNENFELDER M. (1988): Archean zircons in a retrograded, Caledonian eclogite of the Gotthard Massif (Central Alps, Switzerland). *Schweiz. Mineral. Petrogr. Mitt.* 68, 485–490.
- GODARD, G. (1988): Petrology of some eclogites in the Hercynides: the eclogites from the Southern Armorican Massif, France. In: D.C. SMITH (ed.): *Eclogites and eclogite-facies rocks*. Development in Petrology. Elsevier, Amsterdam, 12, 451–519.
- GRAUERT, B. and ARNOLD, A. (1968): Deutung diskordanter Zirkonalter der Silvrettadecke und des Gotthardmassivs (Schweizer Alpen). *Contrib. Mineral. Petrol.* 20, 34–56.
- GREEN, T.H. (1982): Anatexis of mafic crust and high pressure crystallization of andesite. In THORPE, R.S. (ed.): *Andesites: orogenic andesites and related rocks*, John Wiley, Chichester, 465–487.
- HAAR, L., GALLAGHER, J.S. and KELL, G.S. (1984): NBS/MRC Steam Table. Thermodynamic and transport properties and computer programs for vapor and liquid states of water in SI units. Hemisphere Publishing Co., Washington, D.C.
- HOLDAWAY, M.J. and MUKHOPADHYAY, B. (1993): Geothermobarometry in pelitic schists: a rapidly evolving field. *Am. Mineral.* 78, 681–693.
- HOLLAND, T.J.B. (1979): High water activities in the generation of high pressure kyanite eclogites of the Tauern Window, Austria. *J. Geol.* 87, 1–27.
- HOLLAND, T.J.B. (1990): Activities of components in omphacitic solid solutions. An application of Landau theory to mixtures. *Contrib. Mineral. Petrol.* 105, 446–453.
- HOLLAND, T.J.B. and POWELL, R. (1990): An enlarged and updated internally consistent thermodynamic dataset with uncertainties and correlations. The system  $K_2O-Na_2O-CaO-MgO-MnO-FeO-Fe_2O_3-Al_2O_3-TiO_2-SiO_2-C-H_2O_2$ . *J. Metam. Geol.* 8, 89–124.
- HOLLAND, T.J.B. and POWELL, R. (1991): A compensated-Redlich-Kwong (CORK) equation for volumes and fugacities of  $CO_2$  and  $H_2O$  in the range 1 bar to 50 kbar and 100–1600 °C. *Contrib. Mineral. Petrol.* 109, 265–273.
- HUBER, H.H. (1943): Physiographie und Genesis der Gesteine im südöstlichen Gotthardmassiv. *Schweiz. Mineral. Petrogr. Mitt.* 23, 72–260.
- JAMTVEIT, B. (1987): Metamorphic evolution of the Eiksunddal eclogite complex, Western Norway, and some tectonic implications. *Contrib. Mineral. Petrol.* 95, 82–99.
- JAMTVEIT, B., BUCHER-NURMINEN, K. and AUSTRHEIM, H. (1990): Fluid controlled eclogitization of granulites in deep crustal shear zones, Bergen arcs, Western Norway. *Contrib. Mineral. Petrol.* 104, 184–193.
- JOANNY, V., VAN ROERMUND, H. and LARDEAUX, J.M. (1991): The clinopyroxene/plagioclase symplectite in retrograde eclogites: a potential geothermometer. *Geol. Rund.* 80, 303–320.
- KERRICK, D.M. and JACOBS, G.K. (1981): A modified Redlich-Kwong equation for  $H_2O$ ,  $CO_2$ , and  $H_2O-CO_2$  mixtures at elevated pressures and temperatures. *Am. J. Sci.* 281, 735–767.
- KIÉNAST, J.R., LOMBARDO, B., BIINO, G. and PINARDON, J.L. (1991): Petrology of very high pressure rocks from the Brossasco-Isasca complex, Dora Maira Massif, Italian Western Alps. *J. Metam. Geol.* 8, 19–31.
- KLEIN, H. and WIMMENAUER, W. (1984): Eclogites and their retrograde transformation in the Schwarzwald (Fed. Rep. Germany). *Neues Jahrb. Mineral. Monatsh.*, 25–38.
- KRETZ, R. (1983): Symbols for rock-forming minerals. *Am. Mineral.* 68, 277–279.
- LABOTKA, T.C. (1991): Chemical and physical properties of fluids. In: KERRICK, D.M. (ed.): *Contact metamorphism*. Reviews in Mineralogy, Miner. Soc. of America 26, 43–104.
- LEARDI, G., ROSSETTI, P. and COMPAGNONI, R. (1984): Geochemical study of a metamorphic ophiolite sequence from the Val d'Ala (Internal Piedmontese Zone, Graian Alps, Italy). *Mem. Soc. Geol. It.* 29, 93–105.
- LIEBERMAN, J. and PETRAKAKIS, K. (1991): TWEEQU thermobarometry: analysis of uncertainties and applications to granulites from Western Alaska and Austria. *Can. Mineral.* 29, 857–887.
- MÄDER, U.K. (1991):  $H_2O-CO_2$  mixtures: a review of P-V-T-X data and an assessment from a phase-equilibrium point of view. *Can. Mineral.* 29, 767–790.
- MÄDER, U.K. and BERMAN, R.G. (1991): An equation of state for carbon dioxide to high pressure and temperature. *Am. Mineral.* 76, 1547–1559.
- MAGGETTI, M. and GALETTI, G. (1988): Evolution of the Silvretta eclogites: metamorphic and magmatic events. *Schweiz. Mineral. Petrogr. Mitt.* 68, 467–484.
- MERCOLLI, I., BIINO, G.G. and ABRECHT, J. (1994): The lithostratigraphy of the pre-Mesozoic basement of the Gotthard massif: a review. *Schweiz. Mineral. Petrogr. Mitt.* 74, 27–38.
- MERZ, C., THÉLIN, P. and PERSOZ, F.P. (1989): Influences respectives du métamorphisme et de la déformation sur l'état structural des feldspaths potassiques du

- granite de Medel (massif du Gothard, Alpes Centrales Suisses). *Schweiz. Mineral. Petrogr. Mitt.* 69, 359–375.
- NICCOLET, C. and LEYRELOUP, A. (1978): *Pétrologie des niveaux trondhjémiques de haute pression et de leur encaissant élogitique et amphibolitique (Levezou et Marvejols, Massif Central Français). Conséquences sur la genèse des groupes leptyno-amphibolitiques.* *Can. J. Earth Sci.* 15, 696–707.
- NIGGLI, E. (1944): *Das westliche Tavetscher Zwischenmassiv und der angrenzende Nordrand des Gotthardmassivs.* *Schweiz. Mineral. Petrogr. Mitt.* 24, 58–301.
- NIGGLI, E. (1970): *Alpine Metamorphose und alpine Gebirgsbildung.* *Fortschr. Miner.* 47, 16–26.
- OBERLI, F., BIINO, G.G. and MEIER, M. (1993): *Early polymetamorphic evolution of a Central Swiss Alpine terrain examined by single-crystal U–Th–Pb dating techniques.* *Terra abstracts*, 5, 392.
- PFEIFER, H.R., BIINO, G.G., MÉNOT, R.P. and STILLE, P. (1993): *Ultramafic rocks in the pre-Mesozoic basement of the Central and External Western Alps.* In: VON RAUMER, J. and NEUBAUER, F. (eds): *Pre-Mesozoic basement in the Alps.* Springer Verlag, Berlin, 119–143.
- PIFFNER, A.O. (1986): *Evolution of the north Alpine foreland basin in the Central Alps.* *Spec. Publ. int. Ass. Sediment.* 8, 219–228.
- VON RAUMER, J., MÉNOT, R.P., ABRECHT, J. and BIINO, G.G. (1993): *The pre-Alpine evolution of the External Massifs.* In: VON RAUMER, J. and NEUBAUER, F. (eds): *Pre-Mesozoic basement in the Alps.* Springer Verlag, Berlin, 221–240.
- VON RAUMER, J. and NEUBAUER, F. (1993): *Pre-Mesozoic basement in the Alps.* Springer Verlag, Berlin, 677 pp.
- ROSSI, G. (1988): *A review of the crystal-chemistry of clinopyroxenes in eclogites and other high-pressure rocks.* In: SMITH, D.C. (ed.): *Eclogites and eclogite-facies rocks.* Development in Petrology. Elsevier, Amsterdam, 12, 237–270.
- RUBIE, D.C. (1990): *Role of kinetics in the formation and preservation of eclogites.* In: CARSWELL, D.A. (ed.): *Eclogite facies rocks.* Blackie, Glasgow and London, 111–140.
- SCHALTEGGER, U. (1993): *The evolution of the poly-metamorphic basement in the Central Alps unravelled by precise U–Pb zircon dating.* *Contrib. Mineral. Petrol.* 113, 466–478.
- SCHALTEGGER, U. (1994): *Unravelling the pre-Mesozoic history of Aar and Gotthard massifs (Central Alps) by isotopic dating – a review.* *Schweiz. Mineral. Petrogr. Mitt.* 74, 39–50.
- SCHULZ, B. (1993): *P-T-deformation paths of Variscan metamorphism in the Austroalpine basement: controls on geothermobarometry from microstructures in progressively deformed metapelites.* *Schweiz. Mineral. Petrogr. Mitt.* 73, 301–318.
- SERGEEV, S.A. and STEIGER, R.H. (1993): *High-precision U–Pb single zircon dating of Variscan and Caledonian magmatic cycles in the Gotthard Massif, Central Swiss Alps.* *Terra Abstracts* 5, 394–395.
- SMULIKOVSKI, K. (1968): *Differentiation of eclogites and its possible causes.* *Lithos* 1, 89–101.
- TRÜMPY, R. (1969): *Die Helvetischen Decken der Ostschweiz. Versuch einer palinspastischen Korrelation und Ansätze zu einer kinematischen Analyse.* *Eclogae geol. Helv.* 62, 105–142.
- TRÜMPY, R. (1980): *An outline of the Geology of Switzerland.* Wepf and Co. Publishers, Basel: 104 pp.
- THOMPSON, J.B. (1955): *The thermodynamic basis for the mineral facies concept.* *Am. J. Sci.* 253, 65–103.
- WINTERHALTER, R.U. (1930): *Zur Petrographie und Geologie des östlichen Gotthardmassivs.* *Schweiz. Mineral. Petrogr. Mitt.* 10, 38–116.

Manuscript received November 25, 1993; revised manuscript accepted January 25, 1994.