

The distinctive tectonometamorphic evolution of two basement complexes belonging to the Grand-Saint-Bernard nappe (Val de Bagnes, Valais)

Autor(en): **Wust, Gilles H. / Baehni, Luc A.**

Objektyp: **Article**

Zeitschrift: **Schweizerische mineralogische und petrographische Mitteilungen
= Bulletin suisse de minéralogie et pétrographie**

Band (Jahr): **66 (1986)**

Heft 1-2

PDF erstellt am: **23.09.2024**

Persistenter Link: <https://doi.org/10.5169/seals-50881>

Nutzungsbedingungen

Die ETH-Bibliothek ist Anbieterin der digitalisierten Zeitschriften. Sie besitzt keine Urheberrechte an den Inhalten der Zeitschriften. Die Rechte liegen in der Regel bei den Herausgebern.

Die auf der Plattform e-periodica veröffentlichten Dokumente stehen für nicht-kommerzielle Zwecke in Lehre und Forschung sowie für die private Nutzung frei zur Verfügung. Einzelne Dateien oder Ausdrucke aus diesem Angebot können zusammen mit diesen Nutzungsbedingungen und den korrekten Herkunftsbezeichnungen weitergegeben werden.

Das Veröffentlichen von Bildern in Print- und Online-Publikationen ist nur mit vorheriger Genehmigung der Rechteinhaber erlaubt. Die systematische Speicherung von Teilen des elektronischen Angebots auf anderen Servern bedarf ebenfalls des schriftlichen Einverständnisses der Rechteinhaber.

Haftungsausschluss

Alle Angaben erfolgen ohne Gewähr für Vollständigkeit oder Richtigkeit. Es wird keine Haftung übernommen für Schäden durch die Verwendung von Informationen aus diesem Online-Angebot oder durch das Fehlen von Informationen. Dies gilt auch für Inhalte Dritter, die über dieses Angebot zugänglich sind.

The distinctive tectonometamorphic evolution of two basement complexes belonging to the Grand-Saint-Bernard nappe (Val de Bagnes, Valais)

by *Gilles H. Wust*¹ and *Luc A. Baehni*¹

Abstract:

Southern Canton Valais is part of the Penninic realm of the Alpine Arc. At the level of Val de Bagnes, the frontal portion of the Grand-Saint-Bernard nappe has been differentiated into several series. The two most important series are the Siviez and the Métailler basement complexes. An alternation of amphibolites, greenstones and gneissic metabasic rocks constitutes the Siviez series. The Métailler series consists of several metapelitic members imbricated in a complex mixture of subalpine metavolcanic and metabasic rocks including pillows and pillow breccias. The different evolution of the two main series has been reconstructed by microstructural, petrological and geochemical analyses:

- The pre-Alpine Siviez amphibolites have been strongly overprinted by an Alpine "greenschist" facies metamorphism.
- The Métailler series recorded two main Alpine metamorphic events; first "blueschist" then "greenschist" facies.

The distinctive tectonic-metamorphic history of two series belonging to the same tectonic unit favors the concept of a more internal origin for the Métailler series.

Keywords: Pennine Alps, Polyphase processes, Amphibolite facies, Blueschist facies, Greenschist facies, P-T conditions, Geochemistry, Microfabrics.

Résumé:

Le Sud du Valais fait partie du domaine Pennique de l'édifice Alpin. A la hauteur du Val de Bagnes, la partie frontale de la nappe du Grand-Saint-Bernard a été différenciée en plusieurs séries dont les plus importantes sont celles de Siviez et du Métailler. Des roches vertes tantôt amphibolitiques tantôt schisto-gneissiques forment l'essentiel de la série de Siviez. La série du Métailler est essentiellement constituée de roches métabasiques, dans lesquelles s'intercalent des métapelites et quelques ensembles principalement métavolcaniques (pillow lavas, hyaloclastites, tuffites et métagabbros). Des études pétrologiques et microstructurales montrent que:

- Les amphibolites anté-Alpines de Siviez subissent une phase de métamorphisme Alpin de facies «schiste vert».
- La série du Métailler enregistre deux épisodes métamorphiques Alpines: «schiste bleu» puis «schiste vert».

¹ Departement für Erdwissenschaften, ETH-Zentrum, CH-8092 Zurich.

Ainsi l'histoire tectonométamorphique différente de ces deux séries, appartenant à un même ensemble tectonique, suggère une origine plus interne pour celle du Métailler.

Abbreviations:

Act: actinolite	Alb: albite	Bio: biotite
Chl: chlorite	Ctd: chloritoïde	Epi: epidote
Gla: glaucophane	Gre: garnet	Ky: kyanite
Law: lawsonite	Mic: white mica	Pag: paragonite
Qtz: quartz	Sph: sphene	Tc: talc

1. Introduction

This article is an extended version of a talk given at the Symposium "Alpine Metamorphism" held in Bellinzona. It is a synthesis of the authors' Diploma Thesis (E.T.H.-Zurich). For complete microprobe analysis and geochemical data please refer to the original works (BAEHNI, 1985) and (WUST, 1985).

1.1. PREVIOUS RESEARCH

The geological study of the Grand-Saint-Bernard nappe began at the turn of the century. In 1871, GERLACH differentiated the lithologies into basement and cover rocks. Then ARGAND (1916) and WEGMANN (1930) drafted the first outlines of regional tectonics. The stratigraphy was partially described by TRÜMPY (1952) and the petrography was updated by OULIANOFF (1955). SCHAEER (1959, 1960), who was the first to apply "modern" structural analysis to the area, carefully remapped the different series and presented their geological interpretation. Regional tectonometamorphic interpretations for areas to the East and Southwest of this study are presented by BEARTH (1961), BURRI (1983), THÉLIN and AYRTON (1983), STECK (1984) and MARTHALER (1984).

1.2. GEOLOGICAL SETTING

On the Eastern side of Val de Bagnes, a few kilometers East from Verbier, the frontal part of the Grand-Saint-Bernard nappe can be subdivided into (Figure 1):

- The Siviez-Mischabel nappe in which the polymetamorphic crystalline Siviez series, its metasedimentary cover and a thin horizon of polygenic cellular dolomite ("Triassic cargneule"?) have been described.

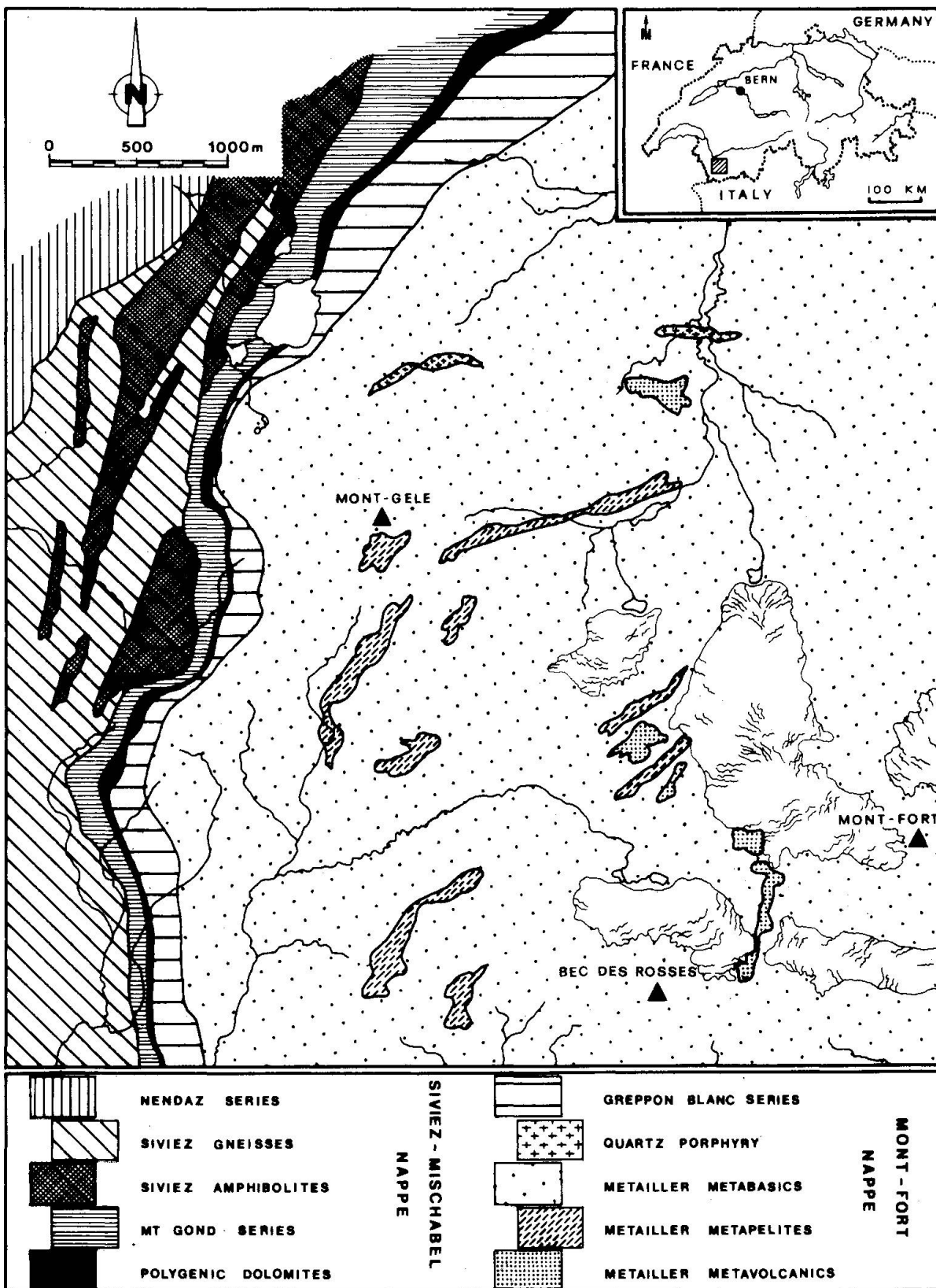

Fig. 1 Geological map of the investigated area.

- The Mont Fort nappe including the thick Métailler complex and its detritic cover.

According to classic palinspastic reconstruction for the upper Jurassic, the Siviez-Mischabel nappe originated from the Briançonnais rise. In contrast, the origin of the Mont Fort nappe and particularly the Métailler series which shows some Piemonte affinities, could be more internal. K-Ar isotopic data (HUNZIKER, 1974) indicates that blue amphiboles from the Mont Gelé area contain excess argon and isochrons are not representative of the high P metamorphism. However other isotopic data made in the region or in equivalent lithostratigraphic units (BOCQUET, 1974) suggest two peaks for the metamorphic conditions:

- Eo-Alpine (± 100 ma, blueschist to eclogitic facies)
- Meso-Alpine (± 38 ma, greenschist to blueschist)

Consequently the distinctive origin and different tectonometamorphic evolution of the Siviez and Métailler basement complexes is interpreted by the study of successive metamorphic mineral parageneses combined with microstructural work, geochemical analyses and published isotopic data.

2. Description of the Siviez Series

2.1. LITHOLOGIES

The Siviez series includes pre-Triassic polymetamorphic rocks (SCHAER, 1960) and (BURRI, 1983) and is characterized by an irregular alternation of schistose gneisses and amphibolitic green rocks.

2.2. THE SCHISTOSE GNEISSES

Depending on the mineralogical composition, the metamorphic foliation of the schistose gneisses vary from a crumbly schist to a massive gneiss. Chlorite (rhipidolite), quartz, albite and muscovite constitute up to 95% of the mode. The chloritic schistose gneisses appear spotted due to albite porphyroblasts (2-5 mm) that contain relicts garnets. Epidote, tourmaline, sphene and magnetite are accessory minerals. Unless included in albite porphyroblasts, most garnets exhibit a high degree of chloritization. Their snowball structure display rotations up to 120°. Garnet profiles reveal a distinct zonation (BAEHNI, 1985): a Ca-depletion associated with a Fe-enrichment from the core towards the rims indicates crystallization during increasing metamorphic grade (BROWN, 1969). According to GANGULY (1969) minimum metamorphic conditions of $\pm 550^\circ\text{C}$ are required for the crystallization of almandine (Figure 2). Therefore the growth of these garnets occurred during an early "amphibolite facies" stage.

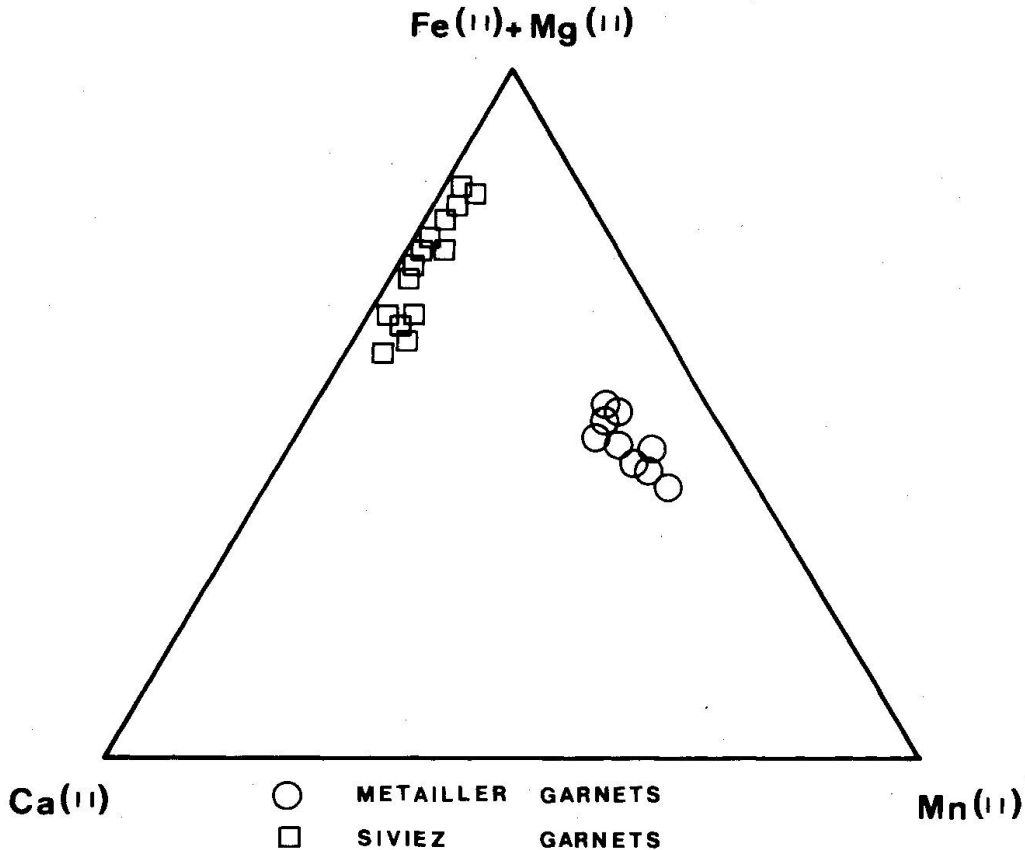

Fig. 2 Plot of the distinctive composition of garnets of the Siviez (□) and Métailler (○) series.

2.3. THE AMPHIBOLITIC GREENSTONES

The variable thickness of these amphibolitic rock masses, local discontinuities and their irregular contacts suggest that they represent original dykes. These compact rocks which sometimes exhibit a slight banding range from pure amphibolites to prasinites or ovardites¹.

The amphibolites mainly consist of pargasitic hornblendes (Figure 3) whose formula $[\text{Na}_{0.3}(\text{Ca}_{1.8}\text{Na}_{0.2})(\text{Mg}_{2.4}\text{Fe}_{1.8}\text{Al}_{0.8})(\text{Si}_{6.3}\text{Al}_{1.7})\text{O}_{22}(\text{OH})_2]$ was obtained by the normalization of microprobe data on the basis of 23 oxygens. Almandine garnets (Figure 2) associated with epidote and biotite have also been observed.

In contrast to amphibolitic rocks, the prasinites display a very high concentration of albite, chlorite and epidote but relict garnets and actinolites are rare.

The replacement of the earlier metamorphic minerals: pargasite, almandine and plagioclase by the lower grade assemblage: actinolite, albite, zoisite and

¹ The term prasinite characterizes rocks with a spotted texture (albite porphyroblasts), containing the assemblage: actinolite, chlorite, albite and epidote. An ovardite is a prasinite without amphibole.

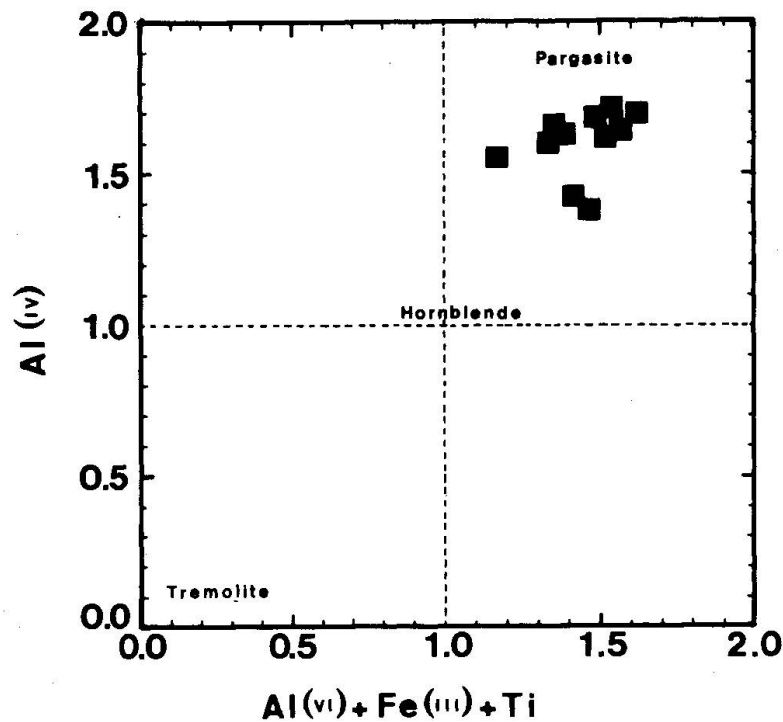

Fig. 3 Plot of amphibole composition in the Siviez series (normalization on the basis of 23 oxygens).

chlorite suggests the overprint of “green schist” over “amphibolitic facies” (WINKLER, 1979). The primary metamorphic mineral assemblages of the amphibolites and of the schistose gneisses imply minimal conditions of $\pm 550^{\circ}\text{C}$.

This amphibolite facies metamorphism that initiates the common metamorphic evolution of both lithologies is unknown in this particular region during the Alpine events. Therefore it must be pre-Alpine.

3. Description of the Métailler Series

3.1. THE LITHOLOGIES

The Métailler series constitutes a very thick schisto-gneissic complex. Its lithologies have been subdivided into three groups; the main rock body consists of metabasic rocks that are irregularly intercalated with metapelitic slices and rare metavolcanic zones.

A) The metabasic rocks, often termed “greenstones”, include a large variety of prasinities and some glaucophanites. In chronological order of crystallization the main phases are: (1) Gla-Epi-Mic-Qtz-Sph, (2) Act-Epi-Mic-Qtz-Sph, and finally (3) Alb-Chl-Qtz-Bio.

B) The first metapelitic paragenesis is: Qtz–Mic–Epi–Sph. During the second stage two diverging trends are apparant. We have observed a garnetiferous trend with the assemblage: Gre–Qtz–Mic–Epi–Chl and a chloritoid-rich trend characterised by: Ctd–Qtz–Mic–Epi–Chl. The last paragenesis, Qtz–Mic–Chl, is common to both trends.

C) The metavolcanic lithologies are comprised of pillow lavas whose elliptical shape are well preserved. Here and there deformed peduncles persist. Their variolitic rims are enriched with epidote and chlorite. Radial networks of fine formerly vitrified seams crisscross their exposed sections. Highly recrystallized masses found around and between the pillow lavas have been interpreted as hyaloclastite or pillow-breccia. Adjacent masses of solid rocks resembling the pillow lavas, but without their typical structure, are interpreted as massive lavas. Surrounding the pillow lava horizons, the metatuffites of volcanoclastic metasediments are characterized by albite megaporphyroblasts (1 cm) and a relatively high quartz and mica content. The metavolcanic lithologies display a crystallization sequence identical to the metabasites. Their geochemical analyses are presented in section 3.4.

The presence of an Alpine “blueschist” facies metamorphism assign a pre-Cretaceous origin for the Métailler series and the lack of pre-Alpine metamorphism suggests a post-Hercynian age.

3.2. MICROPROBE DATA

The composition of the chloritoid is typically poor in Mg ($\pm 3\%$). The high Mn content (2.8%) of the chloritoid is related to a relatively low Mn concentration in the rock, hindering the crystallization of spessartine. Consequently most Mn concentrates in chloritoides.

Muscovite is the most common white mica. The phengitic components with 3 T polymorph probably originated during the Eo-Alpine high-pressure/low-temperature metamorphism (FREY et al., 1983). Paragonite is very rare.

Microprobe analyses of blue amphiboles are plotted in the diagram (Figure 4) proposed by MIYASHIRO (1957). Two options were considered for their normalization (ROBINSON et al., 1982):

- total cation to 15 exclusive of K (exclusion of Na in A position)
- total cation to 13 exclusive of Ca and Na (exclusion of Mg in M4 position)

The garnets of the Métailler series differ from the garnets of the Siviez series (Figure 2). Their composition is intermediate between almandine and spessartine with a minor grossular component. They also display a different zoning with Mn-enriched and Fe-poor cores to Mn-depleted and Fe-enriched rims. There is no magnesium or calcium trend. The peripheral increase of the Fe component suggests crystallization during conditions of increasing temperature (BROWN, 1969).

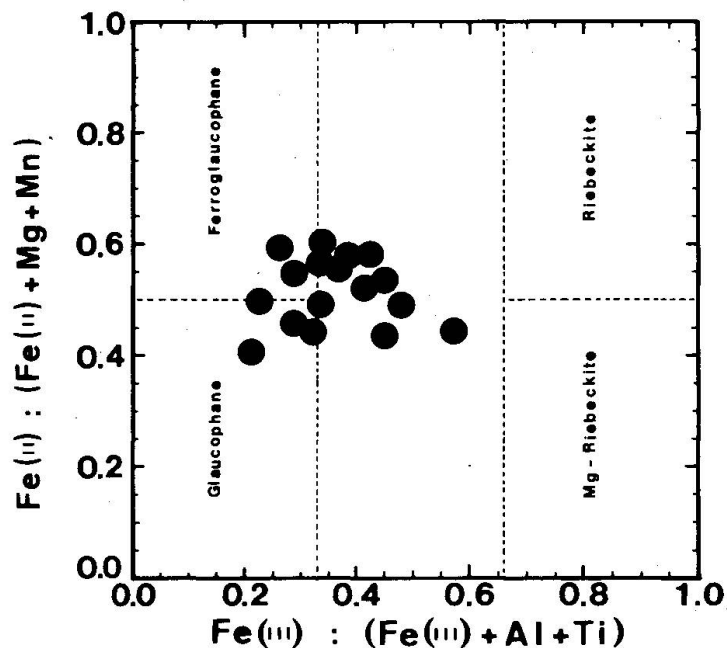

Fig. 4 $\text{Fe}^{2+}/\text{Mg} + \text{Fe}^{2+} - \text{Fe}^{3+}/\text{Fe}^{2+} + \text{Al}$ diagram for amphibole composition in the Métailler series.

3.3. P-T CONDITIONS

The data shown in figures 5 and 6 were gathered to provide information on the petrological evolution of metabasic rocks of the Métailler series and to evaluate pressure and temperature conditions. The system under investigation includes 6 components: Na_2O ; CaO ; $(\text{Fe},\text{Mg})\text{O}$; $(\text{Al},\text{Fe})_2\text{O}_3$; SiO_2 and H_2O and 9 phases: Glaucophane (Gla), Albite (Alb), Actinolite (Act), Lawsonite (Law), Paragonite (Pag), Chlorite (Chl), Epidote (Epi), Quartz (Qtz) and Water (H_2O)

1.	10 Law + 1 Act	=	1 Chl + 6 Epi + 7 Qtz + 14 H_2O
2.	1 Alb + 4 Law	=	1 Pag + 2 Epi + 2 Qtz + 6 H_2O
3.	2 Act + 5 Pag + 2 H_2O	=	5 Alb + 2 Chl + 2 Epi + 4 H_2O
4.	10 Alb + 3 Act + 18 Law	=	5 Gla + 12 Epi + 14 Qtz + 28 H_2O
5.	5 Gla + 12 Law	=	10 Alb + 3 Chl + 6 Epi + 7 Qtz + 14 H_2O
6.	50 Alb + 6 Act + 9 Chl	=	25 Gla + 6 Epi + 7 Qtz + 14 H_2O
7.	13 Alb + 3 Chl + 1 Qtz	=	5 Gla + 3 Pag + 4 H_2O
8.	6 Act + 9 Pag + 11 Alb	=	10 Gla + 6 Epi + 10 Qtz + 2 H_2O
9.	50 Pag + 26 Act + 6 H_2O	=	25 Gla + 11 Chl + 26 Epi + 47 Qtz
10.	5 Gla + 52 Law	=	10 Pag + 3 Chl + 26 Epi + 27 Qtz + 74 H_2O
11.	22 Law + 5 Gla	=	3 Act + 10 Pag + 8 Epi + 6 Qtz + 32 H_2O
12.	6 Chl + 28 Qtz	=	6 Ky + 5 Tc + H_2O

Tab. 1 Reactions amongst the nine (+2) phases considered in the system.

(Tab. 1.). Note that quartz, epidote and water are always in excess and act as the projection phases in the modified "AFM de luxe" diagram of J. B. THOMPSON which is shown on the right of figure 5. Their chemographic relationships are depicted in the same figure whose topology exhibit 4 stable invariant points in a maximum closure net (DAY, 1972): [Alb], [Pag], [Act] and [Law]. During dehydration reactions, water is kept on the right of the reaction curve. Similarly, the stability field of the glaucophane always corresponds to the higher pressures. The dotted area represents the pressure-temperature field in which the Métailler metabasics were possibly metamorphosed. Because lawsonite only appears as questionable pseudomorphs, the rocks have to be kept out of its stability field in the presence of glaucophane, epidote, quartz and water, to the right of reaction curves #2 and #10. The stability field of glaucophane is limited to the right by curve #9. Reaction curve #7 is important because it regulates the appearance and disappearance of paragonite in the presence of glaucophane. Indeed, the scarcity of paragonite could be explained by its reaction with the abundant blue amphiboles. Reaction curve #6 represents the transition between typical medium temperature "blue schist" and upper "green schist" facies. Following a pressure drop, glaucophane would react completely with water (which is in excess) and would produce the ubiquitous albite, actinolite, chlorite and epidote paragenesis.

The orientation of the phase diagram in pressure and temperature conditions is shown in figure 6. The slopes of the reaction curves have been calculated with thermodynamic data from CHERNOSKY (1974) for chlorite (clinochlore), HELGESON et al. (1974) for water, HELGESON et al. (1978) for glaucophane and the U.B.C thermodynamic data bank for the other phases. The invariant [Gla] point was chosen as a starting point. Its location is situated at the intersection of the metastable extension of curve #3 with curves #1 and #2. It lies at approximately 8400 bar and 365°C. The paragonite invariant point [Pag] was placed on curve #1 at ±8000 bar and ±355°C. It is consistent with the investigations of PERCHUCK & ARANOVICH (1980). As discussed further, placing the point further down (7800 bar) would consequently locate the [Law] invariant point too close to curve #12 where chlorite reacts with quartz to produce kyanite, talc and water (MASSONE et al., 1981). Moreover at higher pressures, reaction curve #12 would overlap the area in which chlorite is stable. From [Pag] invariant point curve #5 intersects curve #2 and defines the nearby [Act] invariant point. The [Law] invariant point is located at the intersection of #3 curve and two reaction curves with very low slopes: #6 that originates at the [Pag] invariant point and #7 that originates at the [Act] invariant point. The problematic location of the [Alb] invariant point can be related to the unpredictable behaviour of chlorite bearing reaction curves at high pressure. This point must be located to the left of curve #12 which has a negative slope; therefore at a temperature lower than ±550°C. In order for curves #1, #9 and #10 to meet, the steepness of curve #1

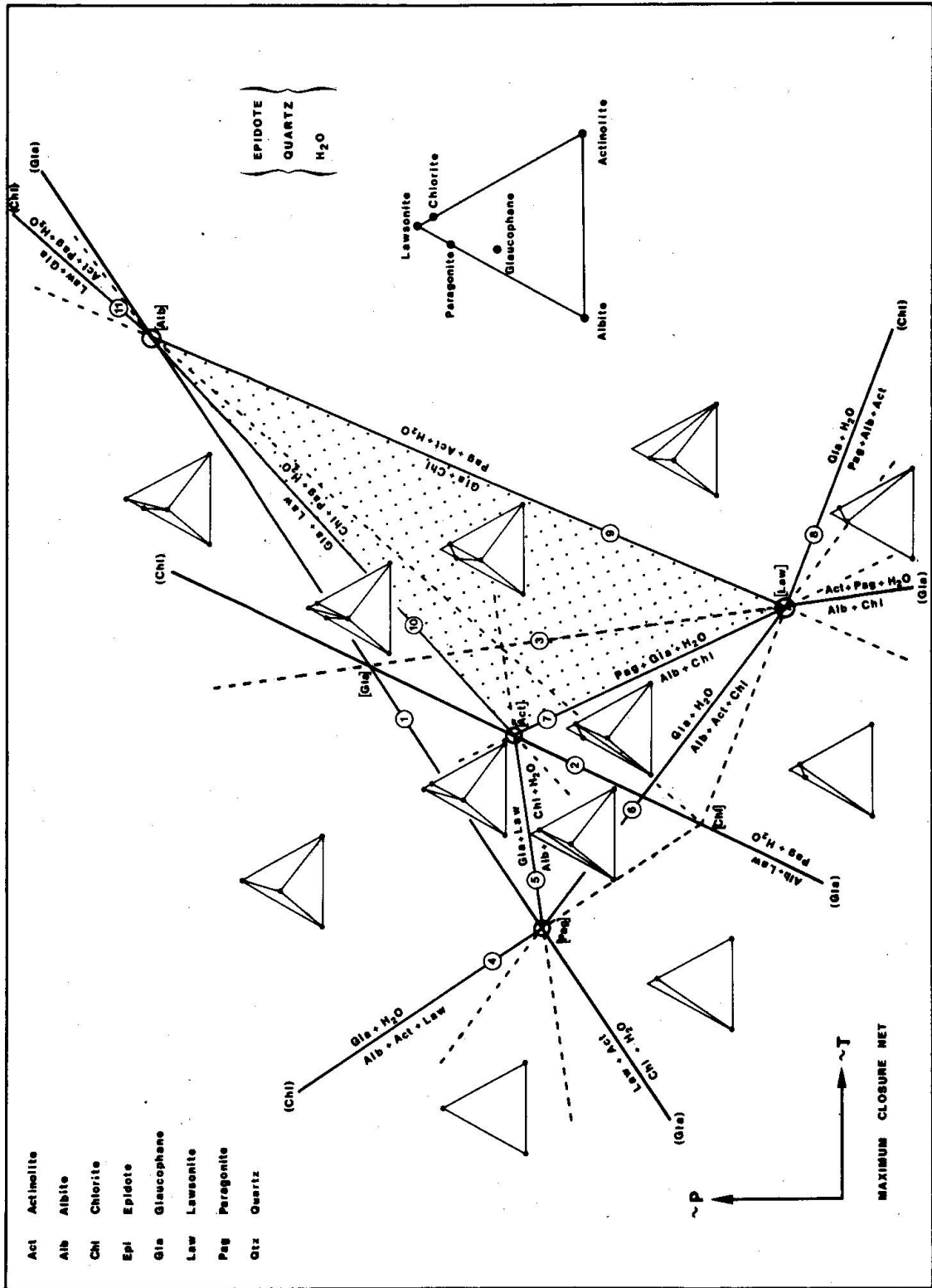

Fig. 5 Chemographic relations of the modified "AFM de luxe" system among Glaucofane (Gla), Albite (Alb), Actinolite (Act), Lawsonite (Law), Paragonite (Pag), Chlorite (Chi), Epidote (Epi), Quartz (Qtz) and Water (H₂O). The dotted area represent the field in which the Métailler metabasics could have been metamorphosed.

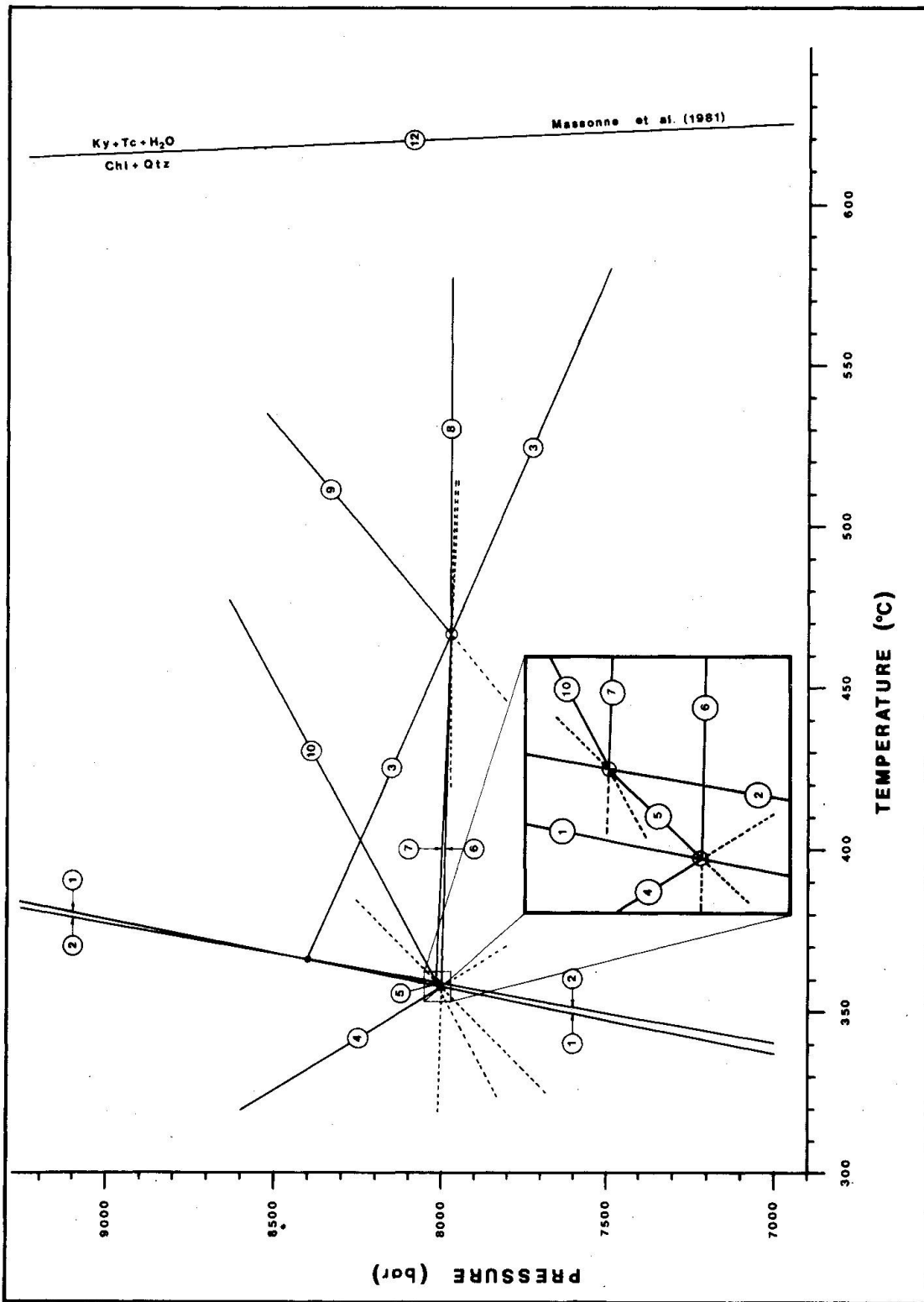

Fig. 6 Orientation of the schematic phase diagram of Figure 5 in P-T conditions.

should decrease. In contrast the slopes of curves #9 and #10 steepen significantly with increasing temperature.

Note that if the position of the [Pag] invariant point could be located very accurately, reaction curve #6 could be used as an efficient barometer.

We can conclude that the "glaucophanites" of the Métailler series underwent a medium temperature "blueschist" facies event with pressure exceeding 8000 bars and temperatures between 360–470 °C. This was followed by a possibly isothermal pressure drop that produced an omnipresent "greenschist" facies retrometamorphism.

3.4. GEOCHEMISTRY OF THE METAVOLCANIC LITHOLOGIES

In order to establish the origin (alkaline, calc-alkaline or tholeiitic differentiation series) of the metavolcanic lithologies found in the Métailler series, geochemical analyses were carried out on 12 samples of pillow lavas, 2 samples of hyaloclastites, 2 samples of volcanoclastic sediments and 1 sample of massive lava (BAEHNI, 1985). The X.R.F. was utilised to determine the main and trace element contents of the samples. It appears that the metatuffites and the hyaloclastites contain a late enrichment of mobile elements such as: Na, K, Rb, Sr and Ba. This enrichment is not observed in the pillow lavas. Due to the immobile hygromagmatophile (HYG) elements (e.g. Nb, Zr, Ti, Y) (WOOD & JORON, 1979) which they include, the pillow lavas are the best indicators of differentiation trends. The analysis shows that most elements typical of an alkaline series (Na₂O, K₂O, Rb, Ba, Sr) have been strongly remobilized. In spite of possible post-magmatic metasomatic enrichment of these elements, the pillow-lavas dis-

	METAILLER SERIES			MORB TYPES			COMBIN SERIES	
	L-277B	L-281B	L279	N-MORB	T-MORB	E-MORB	PR2225	UE2298
Y	17	28	24	25	35	36	40	61
Zr	174	255	283	100	110	290	129	224
Nb	18	31	33	3	13	31	3	29
Cr	254	117	126	250	317	66	305	386
Ni	117	59	74	100	106	15	112	173
Zn	174	121	113	60	87	133	108	183
TiO ₂	2.20	2.98	2.64	1.50	1.74	5.22	1.58	2.40
P ₂ O ₅	0.36	0.57	0.61	0.15	0.22	0.56	0.22	0.17

Y, Zr, Nb, Cr, Ni, Zn : ppm
TiO₂, P₂O₅ : % total weight

Tab. 2 Trace elements content of the Métailler metavolcanics compared with 3 MORB analyses (DIETRICH et al., 1984) and metabasalts of the Combin zone of the Valtoumanche (DAL PIAZ et al., 1981).

play subalkaline affinities. Moreover relatively high concentrations of Cr, Ni, Ti, Nb, Zr and Y exclude the possibility of a calc-alkaline volcanism or an island arc type of origin. Likewise, because of their excessive concentration of Nb, Zr, and Y the protolith was not a normal (N-type) MORB. However, a comparison with different types of MORB analyses (Tab. 2) (DIETRICH et al., 1984) shows similarity with an enriched (E-type) MORB that RICHARDSON et al. (1982) found in the Walvis Ridge (South Atlantic). Our results are in accord with the investigations made by DAL PIAZ et al. (1981) on metabasalts of the Combin zone in the Valtournanche.

Despite the absence of an complete ophiolitic suite, the metabasaltic lithologies of the Métailler series belong to a submarine series characterized by an E-type MORB composition, originating at a spreading center rather than from an island arc or a continent.

4. Structures

From a study of the tectonic structures, four deformation phases are apparent and these may be correlated with various crystallisation events deduced from the petrological analysis. Detailed field observations were only made on the last three stages which appear to correspond to Alpine tectometamorphic events. In the following discussion, D refers to a deformation, P to a fold and S to a foliation.

4.1. DEFORMATION PHASES

The first deformation phase D1 is probably pre-Alpine. It is preserved in snowball garnets associated with the pargasitic hornblendes exclusively present in the amphibolites of the Siviez series.

The second deformational event D2 produced tight to isoclinal folds with N-S trending axes and an ubiquitous metamorphic banding. The large number of quartz rods found everywhere are the result of massive quartz remobilization in the hinges of isoclinal P₂ folds. Similarly, because of their very strong anisotropy, metavolcanic lithologies (pillow-lavas) are probably best preserved in former mega-hinges. The S₂ metamorphic foliation which has been almost totally transposed by S₃ is rarely visible. Thin section studies reveal a discrete S₂ foliation defined by zoned allanites and blue amphiboles folded by P₃ folds.

The third deformation phase D3 is represented by a large number of class 1B folds (RAMSAY, 1967) whose wave length and amplitude vary with lithology.

Their axial planes strike NNE-SSW and dip $\pm 20^\circ$ to the SSE. The S_3 schistosity is the dominant foliation in the entire area. The axial traces of P_3 folds show a strong dispersion. This corresponds to field observations that include bent fold axis and minor P_3 hinges relying each other. These characteristics can be explained by the superposition of the third deformation phase by the fourth phase.

The latest deformation phase D4 can be correlated with a backfolding event. The sub-vertical axial planes of P_4 folds trend N 100-120° E. Their amplitude ranges between a few centimeters to one meter. An associated crenulation cleavage is found in perfectly symmetrical class 1C to 2 microfolds. Locally there are well developed discrete crenulation cleavages.

Unfortunately the absence of distinctive lithologic marker horizons makes it impossible to discover fold structures or to know if the localized thickening of the Métailler series is the result of tectonic duplication by folding or thrusting. Although there are local variations, the deformation style of both series is essentially homogenous.

4.2. MICROSTRUCTURES

A microstructural study was carried out to determine the orientation of the principle strain directions that affected the crystallization of various minerals during the last two Alpine deformation phases. Three large thin sections from sample #G-211 (garnetiferous metapelite of the Métailler series), perpendicular to each other, were oriented and cut according to the S_4 foliation that roughly correspond to N-S, W-E, Up-Down directions (Figure 7). Thin section #G-211 A (top circle) contains two sheef-like nesosubsilicate crystals, a weathered garnet with a chlorite pressure shadow and a large garnet with a quartz and a chlorite pressure shadow. Thin section #G-211 P (middle circle) displays two epidote crystals with quartz filled fractures, an epidote replaced by quartz and chlorite, a garnet with symmetrical pressure shadows. Thin section #G-211 H (bottom circle) displays two garnets whose quartz and chlorite pressure shadows have a "fried egg" appearance and a garnet "cut" by an epidote crystal. The orientation of pressure shadows around garnets, epidotes and opaques and the disposition of quartzose healing joints in the epidotes were used to determine the strain directions during D4. As the growth of garnet is not influenced by stress, information about D3 was inferred from the orientation of the newly crystallized epidote.

Figure 8 shows the postulated principle strain directions during the last deformational event D4 (top) and the third deformation phase D3 (bottom). The last event is a N-S compression of the white reference cube causing a W-E extension of the pressure shadow illustrated by the striped parallelepiped. During

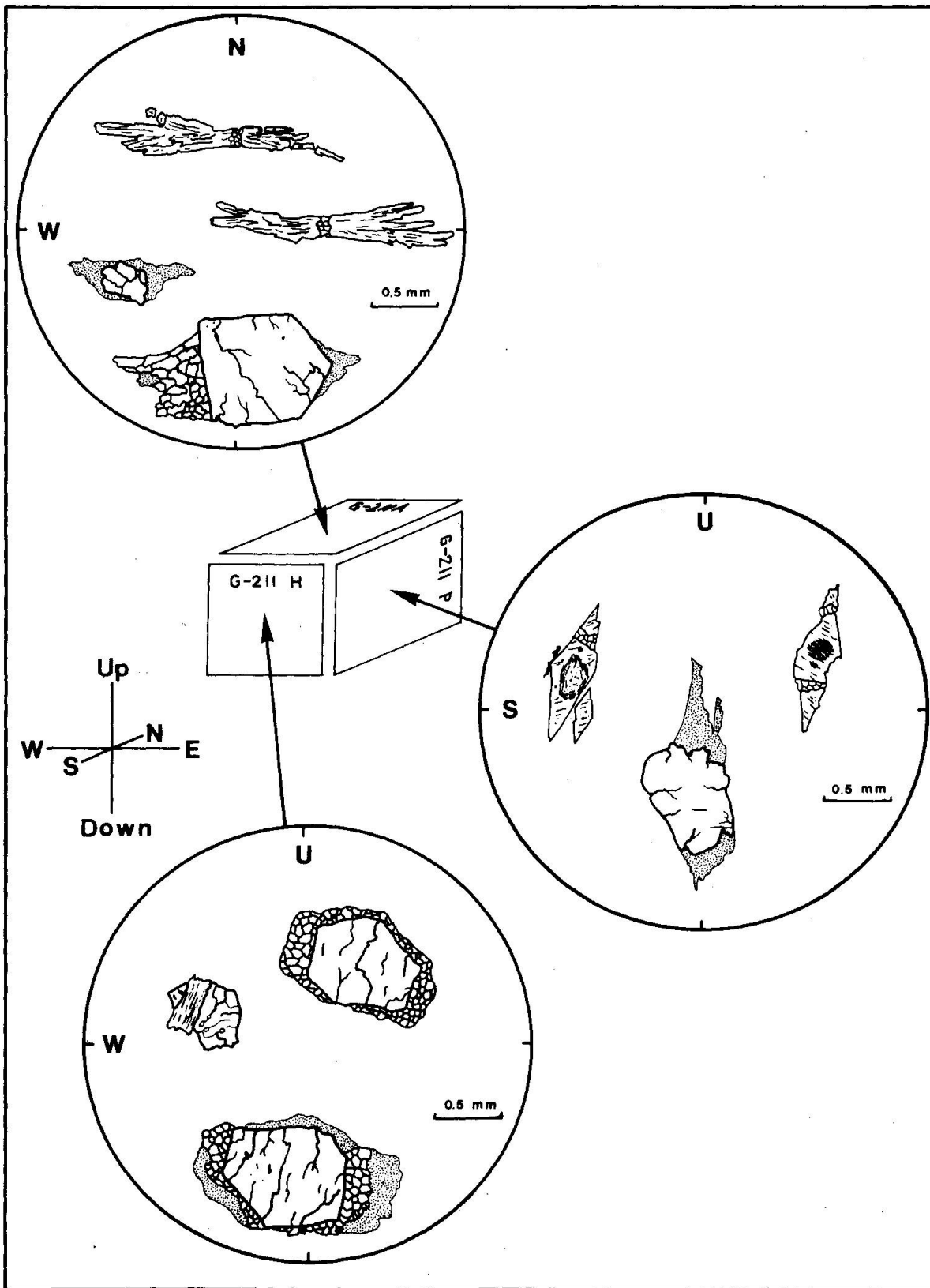

Fig. 7 3-D study of crystal growth. The orientation of the three maxi thin sections according to the last foliation correspond \pm to N-S, W-E and Up-Down directions.

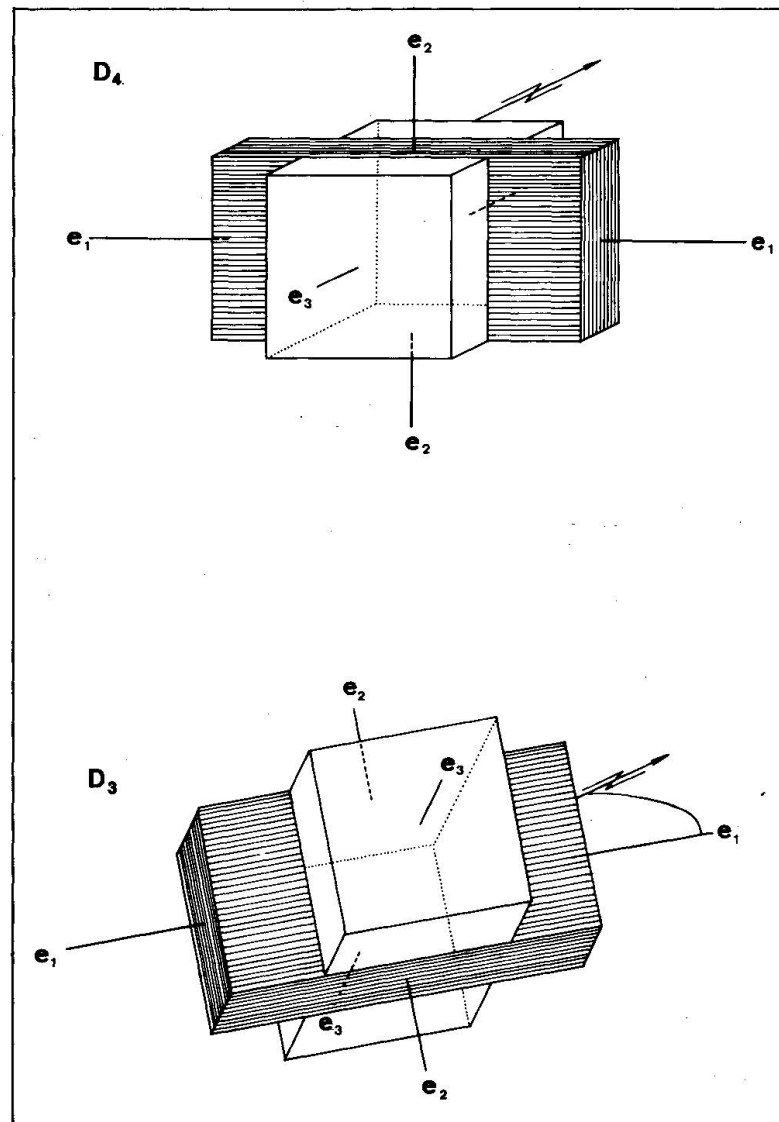

Fig. 8 Principle strain directions during the last deformational event D_4 (top) and the third deformation phase D_3 (bottom).

the third deformation phase, the resulting striped parallelepiped is aligned in the plane of the main S_3 schistosity. Such a rotation of the paleostrain is consistent with the two stages chlorite pressure shadow and sigmoidal quartzitic tension gashes observed in other garnets of the Métailler series (Figure 9).

5. Conclusion

The investigation suggests a different origin and a distinctive tectonometamorphic evolution for the Siviez and Métailler series at the level of Val de Bagnes.

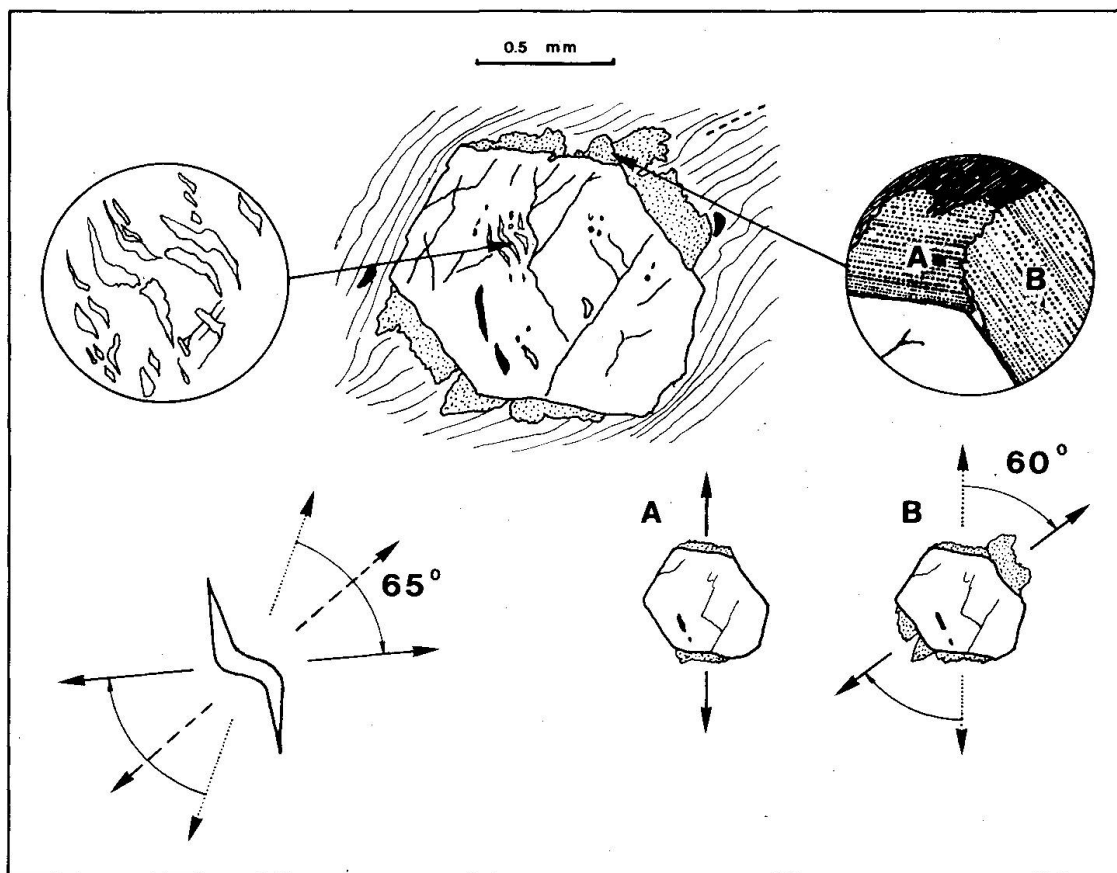

Fig. 9 Sygmooidal quartz tension gashes and the two generations of chlorite pressure shadow around garnets of the Métailler series display a 60° rotation.

The Siviez series displays a pre-Alpine “amphibolitic” facies paragenesis. In contrast, the Métailler series contains mineral assemblages that are exclusively Alpine. Despite similarities in the lithology of these two groups, pillow lavas and associated rocks of oceanic origin (E-type MORB) have only been found in the Métailler series. This implies that the Métailler series is younger and that its origin is more internal than the Siviez series.

The transition of the alpine “blueschist” to “greenschist” facies of the Métailler series may be related to its subduction and uplift during the Alpine orogeny. In contrast, the overprint of a “greenschist” facies over an “amphibolitic” facies displayed by the Siviez series, is enigmatic. If they had a common history, lithologies with similar bulk compositions of the two series should exhibit similar mineral parageneses.

We conclude that the evolution of the Siviez series began during a pre-Alpine event. Then, the first Alpine orogeny affected only the Métailler series or was not registered by the Siviez series (possibly due to a different H_2O content of the series). Finally, both series joined a common retrometamorphic path.

Acknowledgements

J.G. Ramsay and V. Trommsdorff kindly reviewed the manuscript. They also must be thanked for their support and availability throughout our studies. J.P. Schaer was very cooperative and provided fruitful comments. J. Ganguin shared his experience of the multi-systems and supervised the P-T analysis. Revising the English, D.S. Silverberg helped to clarify several problems. Thanks to B.W. Allenbach and L. Diamond for their help and comments. Material support was provided by the Institut für Mineralogie und Petrographie (A. Stahel and V. Trommsdorff).

References

- ARGAND, E. (1916): Sur l'arc des Alpes occidentales. *Eclogae geol. Helv.*, 14, 145-191.
- BAEHNI, L. A. (1985): Géologie et aspects pétrographiques de la région du Col des Mines-Mt-Gelé, Val de Bagnes, Valais. Unpubl. Travail de Diplôme, E.T.H.-Zurich, 108 p.
- BEARTH, P. (1961): Contribution à la subdivision tectonique et stratigraphique du cristallin de la nappe du Grand-St-Bernard dans le Valais. *Mem. Soc. Géol. de France (à la mémoire du Prof. Fallot)*, vol. 2, 407-418.
- BOCQUET, J., DELALOYE, M., HUNZIKER, J. C. & KRUMMENACHER, D. (1974): K-Ar and Rb-Sr dating of the blue amphiboles, micas and associated minerals of the western Alps. *Contr. Mineral. Petrol.*, 47, 7-26.
- BURRI, M. (1983): Description géologique du front du Grand-Saint-Bernard dans les vallées de Bagnes et d'Entremont (Valais). *Eclogae geol. Helv.*, 76/3, 469-490.
- BROWN, E. H. (1969): Some zoned garnets from the greenschist facies. *Amer. Mineralogist*, 54, 1662-1677.
- CHERNOSKY, J. V. (1974): The upper stability of chloritoid at low pressure and the free energy of formation of Mg-cordierite. *Amer. Mineralogist*, 59, 496-507.
- DAL PIAZ, G. V., VENTURELLI, G., SPADEA, P. & DI BATTISTINI, G. (1981): Geochemical features of metabasalts and metagabbros from the piemonte ophiolite nappe, western Italian Alps. *N. Jb. Miner.*, 142/3, 248-269.
- DAY, H. W. (1972): Geometrical analysis of phase equilibria in ternary systems of six phases. *Amer. J. Sci.*, Vol. 272, 711-731.
- DIETRICH, V. J., CARMAN, M. F., WYTENBACH, A. & MCKEE, E. H. (1984): Geochemistry of basalts from holes 519A, 520, 522B and 524, Deep Sea Drilling Project leg 73 (South Atlantic), *Init. Report DSDP*, vol. LXXIII.
- FREY, M., HUNZIKER, J. C., JEAGER, E. & STERN, W. B. (1983): Regional distribution of white K-micas polymorphs and their phengite content in the central Alps. *Contr. Mineral. Petrol.*, 83, 185-197.
- GANGULY, J. (1969): Chloritoid stability and related paragenesis: theory, experiments and applications. *Amer. J. Sci.*, Vol. 267, 910-944.
- GERLACH, H. (1871): *Das südwestliche Wallis. Mat. carte géologique Suisse*, livre 9.
- HELGESON, H. C. & KIRKHAM, D. H. (1974): Theoretical prediction of the thermodynamic behaviour of aqueous electrolytes at high pressures and temperatures. *Amer. J. Sci.*, 274, 1089-1198.
- HELGESON, H. C., DELANY, J. M., NESBITT, H. W. & BIRD, D. K. (1978): Summary and critique of the thermodynamic properties of the rock-forming minerals. *Amer. J. Sci.*, Vol. 278A, 1-229.
- HUNZIKER, J. C. (1974): Rb-Sr and K-Ar age determination and the Alpine tectonic history of the western Alps. *Mem. Inst. Geol. Min. Univ. Padova*, 31, 54 p.
- MASSONNE, H. J., MIRWALD, P. W. & SCHREYER, W. (1981): Experimentelle Überprüfung der Reaktionskurve Chlorit + Quarz = Talk + Disthen im System MgO-Al₂O₃-SiO₂-H₂O. *Fortsch. Mineralogie*, Bd. 59, Beih. 1, 122-123.

- MARTHALER, M. (1984): Géologie des unités penniques entre le Val d'Anniviers et le Val de Tourtemagne (Valais, Suisse). *Eclogae geol. Helv.*, 77/2, 395-448.
- MIYASHIRO, A. (1957): The chemistry, optics and genesis of the alkali-amphiboles, *J. Fac. Sci. Univ. Tokyo*, II/11, 57-83.
- OULIANOFF, N. (1955): Note concernant l'origine et le métamorphisme des «Schistes de Casanna» (massif du Métailler dans le Val de Nendaz, en Valais). *Bull. soc. vaud. Sc. nat.*, vol. 66, Nr. 288, 77-91.
- PERCHUK, L. L. & ARANOVICH, L. Y. (1980): The thermodynamic regime of metamorphism in the ancient subduction zones. *Contr. Mineral. Petrol.*, 75, 407-414.
- RAMSAY, J. G. (1967): *Folding and fracturing of rocks*. McGraw-Hill, New York, 568 p.
- RICHARDSON, S. H., ERLANK, A. J., DUNCAN, A. R. & REID, D. L. (1982): Correlated Nd, Sr and Pb isotope variation in Walvis Ridge basalts and implications for the evolution of their mantle sources. *Earth Planet. Sci. Lett.*, 59, 327-342.
- ROBINSON, P., SPEAR, F., SCHUMACHER, J. C., LAIRD, J., KLEIN, C. & EVANS, B. W. (1982): Phases relations of metamorphic amphiboles: natural occurrence and theory. *Miner. Soc. Amer., Reviews in mineralogy*, Vol 9B, 1-211.
- SCHAER, J. P. (1959): Les porphyres quartzifères et les roches volcaniques prétriassiques de la nappe du Grand-Saint-Bernard, Valais, Suisse. *Sonderdruck aus der Geol. Rundschau*, 46, 147-158.
- SCHAER, J. P. (1960): Géologie de la partie septentrionale de l'éventail de Bagnes. *Archives des sciences Genève*, vol. 12, fasc. 4.
- STECK, A. (1984): Structures de déformations tertiaires dans les Alpes centrales. *Eclogae geol. Helv.*, 77, 55-100.
- THELIN, P. & AYRTON, S. (1983): Cadre évolutif des événements magmaticométamorphiques du socle ante-Triassique dans le domaine Pennique (Valais). *Schweiz. mineral. petrogr. Mitt.*, 63, 393-420.
- TRÜMPY, R. (1952): Sur les racines helvétiques et les schistes lustrés entre le Rhône et le Val de Bagnes. *Eclogae geol. Helv.*, 44, 112-115.
- WEGMANN, E. (1930): Über die Metamorphosen der Prasinite in der Saint-Bernard-Decke im Wallis (Schweiz). *Eclogae geol. Helv.*, 23, 683-685.
- WINKLER, H. G. (1979): *Petrogenesis of metamorphic rocks*. 5th ed. Springer Verlag, New York, 348 p.
- WOOD, D. A. & JORON, J. L. (1979): A re-appraisal of the use of trace elements to classify and discriminate between magma series erupted in different tectonic settings. *Earth and Planet Sci. Lett.*, 45, 326-336.
- WUST, G. H. (1985): Géologie et aspects structuraux de la région du Mont Fort-Mont Gelé, Val de Bagnes, Valais. Unpubl. Travail de Diplôme, E.T.H.-Zurich, 211 p.

Manuscript received February 20, 1986; accepted July 1, 1986.