

Dynamic palaeogeography of the open Burdigalian seaway, Swiss Molasse basin

Autor(en): **Allen, Philip A. / Mange-Rajetzky, Maria / Matter, Albert**

Objektyp: **Article**

Zeitschrift: **Eclogae Geologicae Helvetiae**

Band (Jahr): **78 (1985)**

Heft 2

PDF erstellt am: **23.09.2024**

Persistenter Link: <https://doi.org/10.5169/seals-165661>

Nutzungsbedingungen

Die ETH-Bibliothek ist Anbieterin der digitalisierten Zeitschriften. Sie besitzt keine Urheberrechte an den Inhalten der Zeitschriften. Die Rechte liegen in der Regel bei den Herausgebern.

Die auf der Plattform e-periodica veröffentlichten Dokumente stehen für nicht-kommerzielle Zwecke in Lehre und Forschung sowie für die private Nutzung frei zur Verfügung. Einzelne Dateien oder Ausdrucke aus diesem Angebot können zusammen mit diesen Nutzungsbedingungen und den korrekten Herkunftsbezeichnungen weitergegeben werden.

Das Veröffentlichen von Bildern in Print- und Online-Publikationen ist nur mit vorheriger Genehmigung der Rechteinhaber erlaubt. Die systematische Speicherung von Teilen des elektronischen Angebots auf anderen Servern bedarf ebenfalls des schriftlichen Einverständnisses der Rechteinhaber.

Haftungsausschluss

Alle Angaben erfolgen ohne Gewähr für Vollständigkeit oder Richtigkeit. Es wird keine Haftung übernommen für Schäden durch die Verwendung von Informationen aus diesem Online-Angebot oder durch das Fehlen von Informationen. Dies gilt auch für Inhalte Dritter, die über dieses Angebot zugänglich sind.

Dynamic palaeogeography of the open Burdigalian seaway, Swiss Molasse basin

By PHILIP A. ALLEN¹⁾, MARIA MANGE-RAJETZKY²⁾, ALBERT MATTER²⁾
and PETER HOMEWOOD³⁾

ABSTRACT

The offshore zone of the Burdigalian seaway in the Swiss foreland basin was characterized by large banks of shelly sandstones (Muschelsandstein or grès coquillier). The tidal origin of these offshore banks is demonstrated by their close association with tidal sandwaves, but more importantly, by the presence of tidal cycles in the bank toesets. Each group of foreset laminae accumulated in a 14-day neap-spring cycle, under a semi-diurnal tidal regime.

Two types of bank are identified: 1. Tall and steep banks, rich in bioclastic debris are found on either side of the Napf fan in the Seeland area and close to Zürich. They formed under highly asymmetrical tides. 2. Smaller and less steep banks rich in siliciclastic debris and broken fragments of the echinoid *Scutella* are localized in the constricted seaway north of the Napf fan. They formed under a more symmetrical tidal regime.

Tides operated in two distinct cells which acted as essentially closed systems for sediment transport. In the cell west of the Napf fan, heavy minerals indicate an exclusively Western Alpine source. Close to the Napf fan the banks are flooded with epidote as the dominant heavy mineral. In the eastern cell, heavy minerals such as topaz and andalusite were derived from a hinterland in the far northeast (the Bohemian Massif) and mixed with Alpine minerals such as lawsonite and blue amphibole derived from the southeast. The dynamic palaeogeography which we reconstruct results from an integration of sedimentological, petrographical and regional geological data.

ZUSAMMENFASSUNG

Während sich vom Alpenrand her Fächerdeltas (fan deltas) in den schmalen burdigalen Meeresarm des schweizerischen Molassebeckens vorbauten, entstanden, weitab von diesen Schüttungszentren, in dem der Nordküste vorgelagerten Bereich grosse glaukonitführende Schillbänke (Muschelsandstein, grès coquillier). Sie verdanken die Entstehung den Gezeitenströmungen, wie aus ihrer Vergesellschaftung mit Gezeiten sandwellen und vor allem der charakteristischen, durch Gezeiten bedingten zyklischen Anordnung der Vorsatzschichten am Fusse der Bänke hervorgeht. Jede Gruppe von Vorsatzlagen wurde während eines 14tägigen Spring-Nipp-Tide-Zyklus unter einem halbtägigen Gezeitenregime abgelagert.

Zwei Typen von Muschelsandsteinen wurden beobachtet: 1. Mächtige (bis 35 m), steil schräggeschichtete Bänke mit viel bioklastischem Detritus (sandige, glaukonitische Pelecypoden-Packstones) treten beidseits des Napfdeltas, d. h. im Seeland und westlich von Zürich, auf. Sie entstanden durch stark asymmetrische Gezeitenströmungen. 2. Bänke von geringerer Mächtigkeit mit flacher einfallenden Schrägschichten, reich an siliziklastischem und *Scutella*-Schutt, sind vorwiegend auf den eingegengten Seeweg nördlich des Napfdeltas beschränkt. Ihre Entstehung lässt sich auf symmetrischere Gezeitenströmungen zurückführen. Von Lenzburg bis ins Bodenseegebiet wird eine Verzahnung der Muschelsandsteinbänke mit einer küstennahen Grobsandfazies beobachtet.

¹⁾ Department of Geology, University College, P.O. Box 78, Cardiff CF1 1XL, U.K.

²⁾ Geologisches Institut, Universität Bern, Baltzerstrasse 1, CH-3072 Bern, Switzerland.

³⁾ Institut de Géologie, Université de Fribourg, Pérolles, CH-1700 Fribourg, Switzerland.

Die Gezeiten bildeten zwei Strömungszellen, die bezüglich Sedimenttransport weitgehend geschlossene Systeme darstellen. Die Schwermineralzusammensetzung ergibt eine westalpine Herkunft des Sandes in der Zelle westlich des Napfdeltas, während in den ihm vorgelagerten Muschelsandsteinbänken Epidot dominiert. In der östlichen Strömungszelle deutet das Auftreten von Topas und Andalusit auf ein weit entferntes nordöstliches Liefergebiet (Böhmische Masse), dessen Schutt sich mit blauem Amphibol und Lawsonit führenden Sanden alpiner Herkunft (Hörnli delta) vermischte. Die hier rekonstruierte dynamische Paläogeographie beruht auf einer Interpretation sedimentologischer, sedimentpetrographischer und regionalgeologischer Daten.

1. Introduction

In late Early Miocene time ("Burdigalian") the sea flooded the large alluvial plain north of the alpine mountain front (FÜCHTBAUER 1964, TRÜMPY 1980, Fig. 7). As a result the Tethys was linked with the sea in the Pannonian basin (Paratethys) by a narrow seaway of the order of 100 km wide in Switzerland (Fig. 1).

After deposition of a transgressive basal series of sandstones, stable facies belts were established in western Switzerland, ranging from pebbly sandstones deposited in tidal distributaries in the south, to pebbly coquinas of the open Burdigalian seaway (HOMEWOOD & ALLEN 1981). Close to the major fan deltas, such as the Napf fan (Fig. 2), the marine facies belts were less stable, reflecting the advance and retreat of fluvial systems into the Burdigalian sea.

The aim of this paper is to present compelling evidence for the tidal origin of the coquina banks situated along the northern shore of the seaway and to place them within their palaeogeographical setting. An integration of petrographic and sedimentological data provides a highly dynamic view of the open Burdigalian sea. Further studies should refine this preliminary reconstruction.

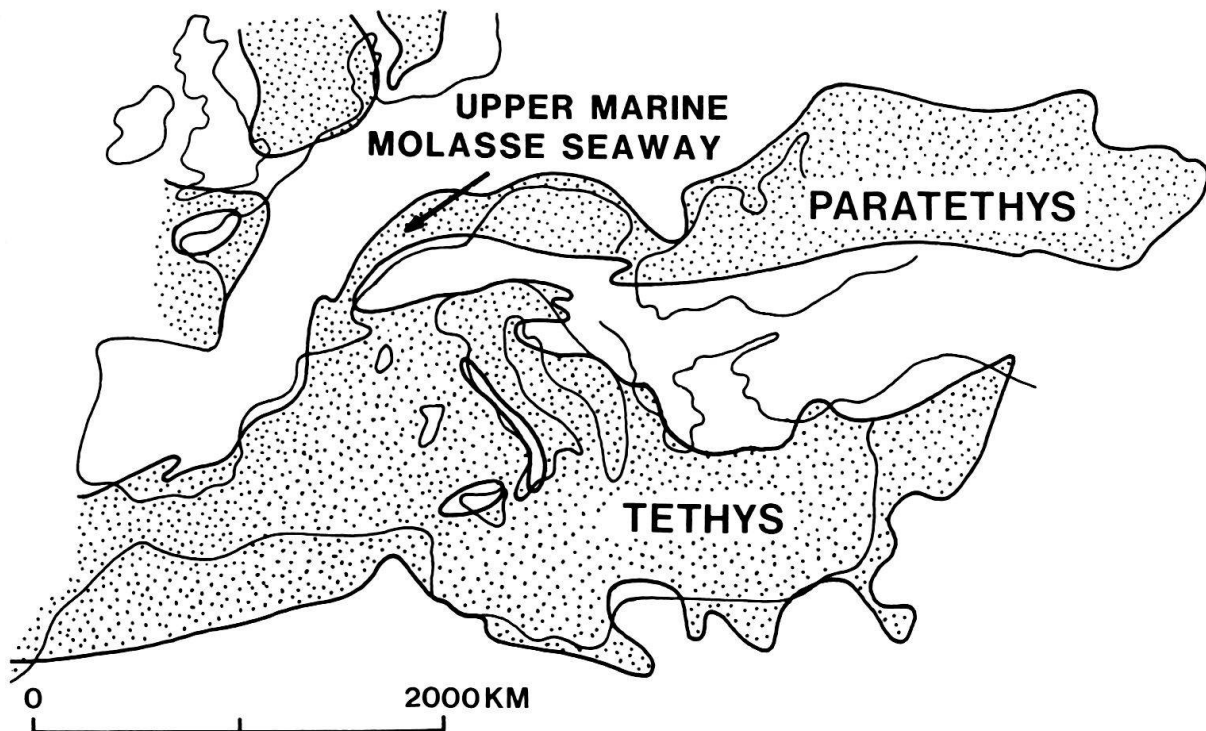

Fig. 1. Regional palaeogeography during Early Miocene (Burdigalian) times (after B. Diem, unpublished).

1.1 Previous studies

The “Muschelsandstein” has been recognized as a distinctive facies of the Molasse for almost 200 years. STUDER (1825) in his “Monographie der Molasse” gives the first detailed description. He recognized that this facies is limited to a zone parallel to the Jura Mountains (subjurassic zone) and can be followed basinwards about halfway towards the alpine front. Studer pointed out that the greatest thicknesses of Muschelsandstein are present in Canton Aargau (Lenzburg area) (Fig. 2) and recognized the great variability of the Muschelsandstein in composition, colour and type of bedding. He described the great abundance of a green mineral in a granular habit and as a replacement of shells which we now know to be glaucony (ODIN & MATTER 1981).

In the past the terms “Muschelsandstein” and the French synonym “grès coquillier” have been used for a range of rock types from a coquina to a shelly sandstone. However, the term should be limited to two lithologies (RUMEAU 1954):

1. Sandy to pebbly shelly limestone (coquina, lumachelle)
2. Medium to coarse calcareous sandstone with pelecypods and other bioclasts

These two varieties should be distinguished from shell-bearing conglomerates (“Muschel-nagelfluh”, STUDER 1825) which have often erroneously been called Muschelsandstein.

Although the earlier authors described the lithology and fossil content of the Muschelsandstein in detail and even noted its cross-bedded nature (e.g. GILLIÉRON 1885, p.392), they did not give a sound environmental interpretation. From the presence of wood, bones and teeth of terrestrial mammals mixed with often fragmented pelecypod valves, shark teeth and other marine bioclasts they concluded that the fauna was a death assemblage. The Muschelsandstein was interpreted as shoals of marine sediment deposited close to the northern, Jura coast (RUMEAU 1954, BECKER 1972).

The heavy mineral composition and presence or absence of coarse sand and “red” quartz enabled BÜCHI & HOFMANN (1960) to show that the siliciclastic detritus of the Muschelsandstein in northeastern Switzerland was derived from both a southwestern alpine source (Napf fan) and a northeastern, Bohemian source (“Grobsandschüttung”). Neglecting cross-bedding as a palaeocurrent indicator they concluded that the Muschelsandstein was deposited in a submarine channel by a west to east flowing current with an opposite current from the east delivering coarse sand (“Grobsand”).

The origin of the Muschelsandstein banks can rarely be elucidated from individual localities, but a reliable picture can gradually be built up from the integration of mineralogical, textural, geometrical and directional data derived from the widely scattered localities between the lakes of Neuchâtel and Zürich (Fig. 2). The documentation of the Muschelsandstein is very far from complete, but there is now sufficient evidence to postulate with confidence a process model for the origin of these marine accumulations.

1.2 Regional distribution and correlation of the Muschelsandstein

The Muschelsandstein facies occurs from Pfullendorf in Germany (north of Lake Constance) to the southwestern erosional limit of the Burdigalian near Lausanne on the shore of Lake Geneva. It has been extensively used as a building stone since Roman times and the best exposures therefore occur in quarries, now mostly disused.

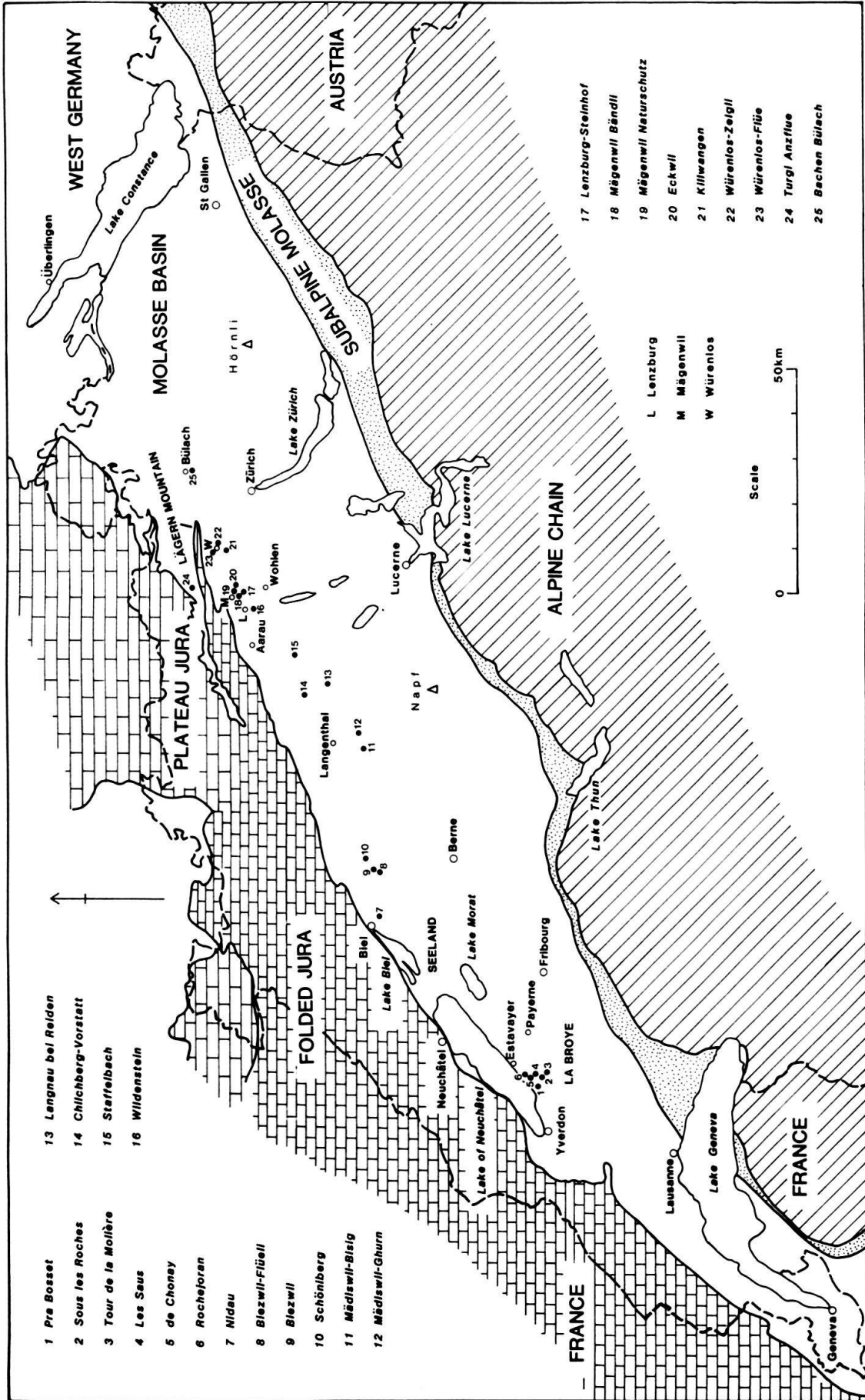

Fig. 2. Location map showing main tectonic units of the Swiss region and exposures of the Muschelsandstein investigated.

North of Lake Constance the facies is present as so-called “Liegender Muschelsandstein”; it occurs at or near the base of the Upper Marine Molasse (OMM) (RUTTE 1952; SCHREINER 1966; WERNER 1966) and is of variable thickness, ranging up to 10 m. It occurs basinwards of the edge of a 40 km wide shallow platform composed of a coastal bioclastic subfacies (“Randengrobkalk”) and a coarse sand subfacies (“Grobsandfazies”) (SCHREINER 1966, Fig. 1). The Liegender Muschelsandstein of the basinal facies is lithologically correlated with the lower part of the Grobsand member of the platform facies by WERNER (1966).

From Lake Constance to the eastern limit of the Jura Mountains at Lägern Mountain (Fig. 2) only a few exposures of small thickness are known. The facies is best developed from Würenlos near Zürich to Langnau (location 13, Fig. 2) in a narrow NE–SW trending zone that parallels the Jura Mountains. This zone is separated from the Grobsand-Randengrobkalk platform facies in the north by the Lägern–Albstein High, which was subaerially exposed, resulting in the development of calcretes (see TRÜMPY 1980, Fig. 7). Westward toward the lakes of Neuchâtel and Murten two coarse grained units are present. The lower one (up to 10 m thick, SCHWAB 1960) is conglomeratic (“Muschelnagelfluh” of STUDER 1825) and fills channels eroded into the Lower Freshwater Molasse (USM). An upper unit of Muschelsandstein rich in bioclastic debris occurs about 60 m higher in the sequence.

Thick banks of Muschelsandstein (similar to the ones between Zürich and Langnau near Reiden) occur again south of Estavayer in the Yverdon area (Fig. 2), whereas to the east in the Payerne area, and probably southwards to Lausanne, individual Muschelsandstein beds are less than 1 m thick and are associated with thick sandstone sequences (RUMEAU 1954).

Muschelsandstein units also occur in front of the Napf and Hörnli fan deltas. GERBER (1982) mapped an extensive lower Muschelsandstein unit (0.4–4 m thick) which inter-fingers with and is replaced southwards by conglomerates of the Napf fan. It may be correlatable with the large banks south of the Jura Mountains (subjurassic zone) and the coarse sand (Grobsand) and bioclastic limestone (Randengrobkalk) facies north of Lake Constance (BÜCHI & HOFMANN 1960). The Muschelsandstein flanking the Hörnli fan near St. Gallen (“Obere Seelaffe”) was interpreted as a coastal sediment formed in less than 50 m water depth (BÜCHI 1950). It is also correlated with the thick banks of the region between Zürich and Langnau (BÜCHI & HOFMANN 1960).

1.3 Composition of the Muschelsandstein

Coquinas, calcareous fine to medium sandstone and calcareous coarse sandstone (Grobsandsteine) are the main lithologies comprising the Muschelsandstein banks. They show compositional, textural and diagenetic variations that are related to depositional environment.

The coquinas are sandy packstones consisting of bioclasts, variable amounts (10–50%) of siliciclastic grains, a small amount of micritic matrix and sparry calcite cement. Most coquinas are very poorly sorted because the bioclastic fragments are generally much larger than the terrigenous detritus. Subangular monocrystalline undulous quartz, fresh orthoclase, microcline and albite together with lesser amounts of plutonic, metamorphic and lithic rock fragments make up 99% of the siliciclastic components of the

coquinas. Volcanic rock fragments occur in trace amounts only. The bioclasts are composed of entire single pelecypod valves and fragmented shells, often dissolved and infilled by void-filling spar. In the area west of the Napf fan and also east of Lägern mountain (BÜCHI 1957; BÜCHI & HOFMANN 1960) the coquinas are glauconitic, sandy pelecypod-packstones with bryozoan fragments and a few planktonic and benthic foraminifera. In between these two areas the coquina banks are glauconitic, sandy pelecypod-echinoderm-packstones with barnacle fragments, gastropods and a few benthic and planktonic foraminifera. The majority of the echinoderm fragments (several centimeters in size) are derived from the echinoid *Scutella*. Shark teeth, terrestrial vertebrate remains, fossil wood and phosphatized fecal pellets of *Scutella* (BÜCHI & WIENER 1967) are minor constituents.

Moderately sorted fine to medium calcareous sandstones are intimately associated with the coquina banks. The carbonate content ranges between 30 and 50%, but this figure reflects a large amount of sparry cement and micritic matrix, and bioclasts are scarce. The composition of the terrigenous fraction and of the bioclasts is identical to that of the associated coquinas. These sandstones are classified as glauconitic calcareous lithic arkoses.

Coarse sandstones (Grobsandsteine) occupy a nearshore facies belt north of Lake Constance and also occur in the Lenzburg area where they interfinger with the coquina facies. The sandstones are fossiliferous glauconitic calcareous sublitharenites and contain a biogenic fraction of fragmented, sturdy, bryozoan colonies, lesser amounts of barnacle, pelecypod and echinoderm debris, rare foraminifera and terrestrial vertebrate remains. Large carbonate pellets and carbonate lithoclasts are common and small reworked caliche nodules are also found.

Glaucyony occurs in amounts up to 5% as sand-sized oval pellets, typically with bulbous and cracked surfaces corresponding to the mature stage of ODIN & MATTER (1981). Radiometric dating suggests that it was reworked from Lower Cretaceous source rocks (FISCHER 1983). However, glaucyony also occurs in voids of various fossils (barnacles, echinoderms, bryozoans) and as a replacement of vertebrate bones, lime pellets, lithoclasts and pelecypod shells, indicating penecontemporaneous glaucyonation.

The coquinas and coarse sandstone possess a heavy diagenetic overprint. The diagenetic phenomena include formation of micrite envelopes, glaucyonation, dissolution of shells with subsequent precipitation of void-filling spar, multiple phase cementation and precipitation of microstalactite cement and deposition of vadose silt, recrystallization of micrite matrix and rare silicification.

Cathodoluminescence microscopy reveals that the dripstone cements found in a few samples consist of at least 30 growth stages, each of slightly different composition. Such inhomogeneous cements are typical of meteoric waters and indicate that the Muschel-sandstein banks were periodically emergent. The banks are overlain by marine sandstones with no noticeable break. The vadose dripstone cements are therefore essentially syndepositional.

2. Petrological provinces

Distinct petrological provinces can be recognized by analysis of the heavy minerals in the Muschel-sandstein (Fig. 3). 94 samples were analyzed from exposures along a SW-NE

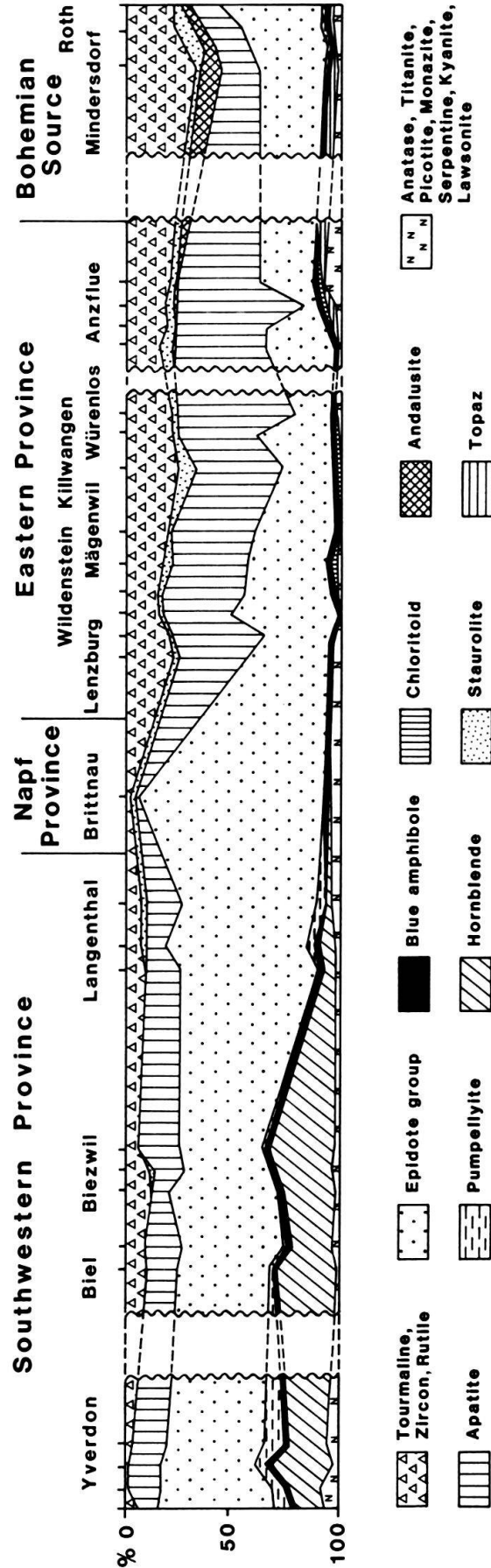

Fig. 3. Correlation section between the lake of Neuchâtel and the lake of Constance showing heavy mineral abundances with garnet excluded.

trending traverse between the southern tip of Lake Neuchâtel and Zürich, using the method introduced by FÜCHTBAUER (1964, 1967). Comparative samples were taken from the coarse sandstones east and northeast of Lake Constance.

Heavy mineral analysis revealed rich and diverse mineral assemblages, with several mineral species belonging to the "unstable" group of PETTIJOHN (1941, 1975), indicating a first-cycle origin. Carbonate cementation at an early post-depositional stage protected the majority of the minerals from circulating corrosive solutions. Three heavy mineral associations are identified based on these new data and previous investigations (FÜCHTBAUER 1964, MATTER 1964).

1. Epidote-apatite-hornblende association with pumpellyite
2. Epidote association
3. Apatite-epidote-ultrastable association, locally with andalusite and topaz

The areal distribution of these heavy mineral associations allows three petrological provinces to be delineated (Fig. 3).

2.1 *Southwestern province*

This province lies between Yverdon and Langenthal and is characterized by the uniform distribution of the *epidote-apatite-hornblende association* and the progressive decrease of pumpellyite towards the east (Fig. 3). Index minerals, occurring in small percentages, are clinopyroxenes and serpentine. Saussurite and composite grains are common and staurolite occurs sporadically. Fibrous amphiboles are found around Biel.

Unstable grains such as hornblende, pyroxene and pumpellyite suggest a first cycle origin. Pumpellyite was probably derived from zeolite-pumpellyite-prehnite facies rocks which are widespread in the Western Alps. This paragenesis is associated with a late phase of Alpine metamorphism (35–13 m.a., BOCQUET et al. 1978). A more complex parentage can be assigned to the hornblendes. Their presence is important, indicating uplift and erosion of hornblende-bearing amphibolite-facies rocks. Hornblendes make their first appearance in Burdigalian Molasse (VERNET 1957, 1958; MAURER et al. 1978, 1983; MANGE-RAJETZKY & OBERHÄNSLI 1982). The source of the pyroxenes, serpentine and part of the hornblende can be traced to the ophiolitic Gêts nappe (Simme nappe s.l.), south of Lake Geneva (Fig. 4) (BERTRAND 1970). Sediments of the modern River Arve near Geneva, which receives detritus from the Gêts nappe through the River Giffre, contain a similar clinopyroxene-hornblende assemblage. Older Molasse and Helvetic flysch (Fig. 4) contributed apatite, garnet and the ultrastable group to the Burdigalian basin and increased the bulk of the light and clay mineral fractions.

The sediment input from the Western Alps into the Burdigalian seaway appears to coincide with the Genfersee (lake Geneva) fan delta which was active during deposition of the Lower Freshwater Molasse (FÜCHTBAUER 1964, 1967; MAURER 1983). Detritus from the Western Alps was joined by sediments from the small Gibloux and Guggisberg fan deltas to the east, draining a Prealpine sourceland (Fig. 4).

2.2 *Napf province*

The mineral spectrum shows a considerable change midway between Langenthal and Aarau, epidote becoming dominant (Fig. 3). This *epidote association* has a similar heavy

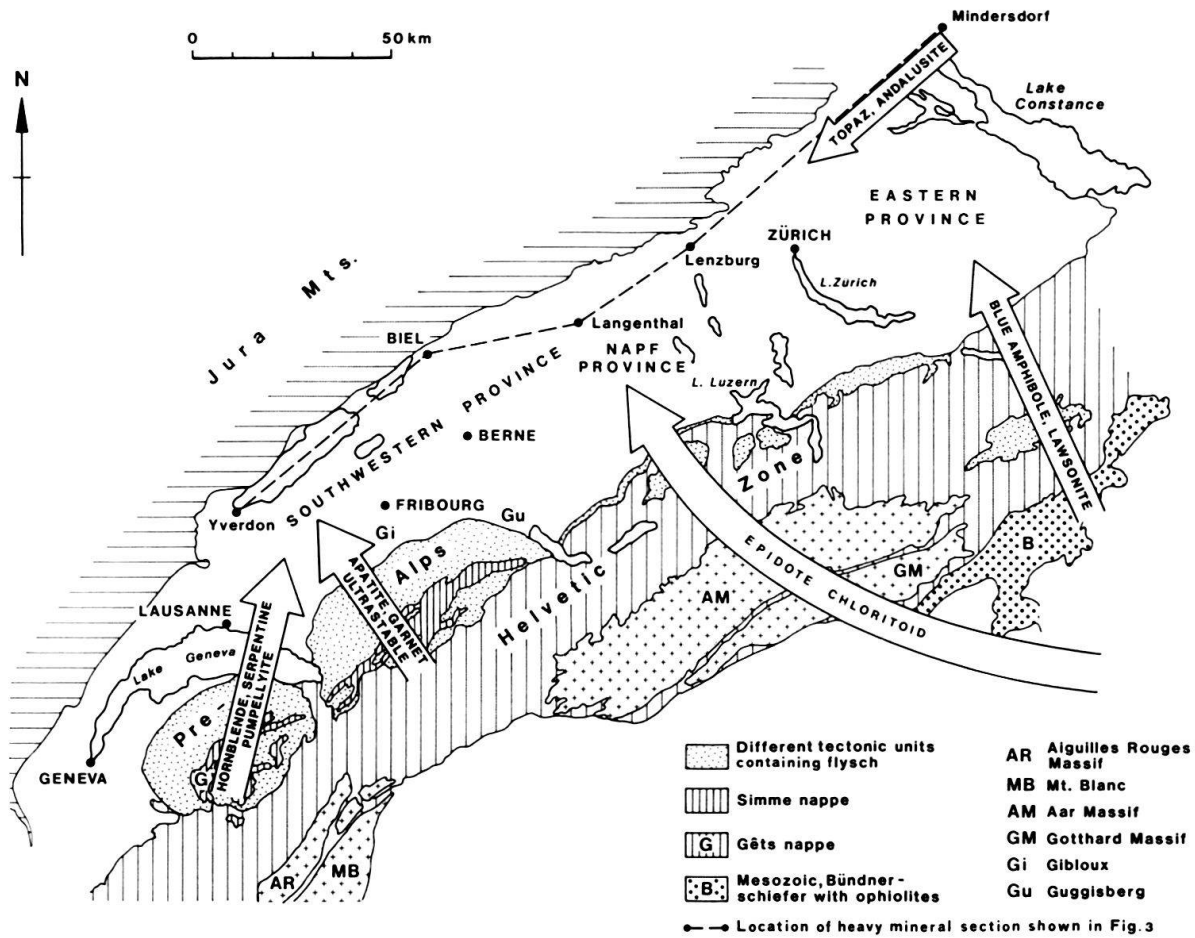

Fig. 4. Petrological provinces of the Molasse basin showing provenance of diagnostic minerals.

mineral composition to the sediments of the Napf-Entlebuch area (MATTER 1964; GASSER 1966; MAURER et al. 1982).

The Napf fan delta (ancestral River Aare), situated between the Lake of Thun and the Lake of Lucerne, dominated the palaeolandscape from the Chattian and was a primary sediment-transporting system (VON MOOS 1935; FÜCHTBAUER 1954, 1964; HOFMANN 1957, 1960; BÜCHI & HOFMANN 1960; MATTER 1964; GASSER 1966; MAURER et al. 1982). Its vast drainage basin extended far into the crystalline massifs of the internal zones of the Alps (Fig. 4).

2.3 Eastern province

East of the Napf province, an *apatite-epidote-ultrastable* association dominates the sediments, with staurolite and chloritoid as common accessories (Fig. 3). Index minerals are blue amphibole, lawsonite and, at certain horizons, andalusite and topaz. A decrease of epidote is coupled with an increase of apatite and the ultrastable group. In the latter, zircon and tourmaline are common, whilst rutile is subordinate. Compared to the other two provinces the amount of garnet is distinctly higher. The diversity of the assemblage suggests a multiple provenance.

The presence of andalusite and topaz led BÜCHI & HOFMANN (1960) and HOFMANN (1976) to assume extra-Alpine parent rocks and to correlate these sediments with the

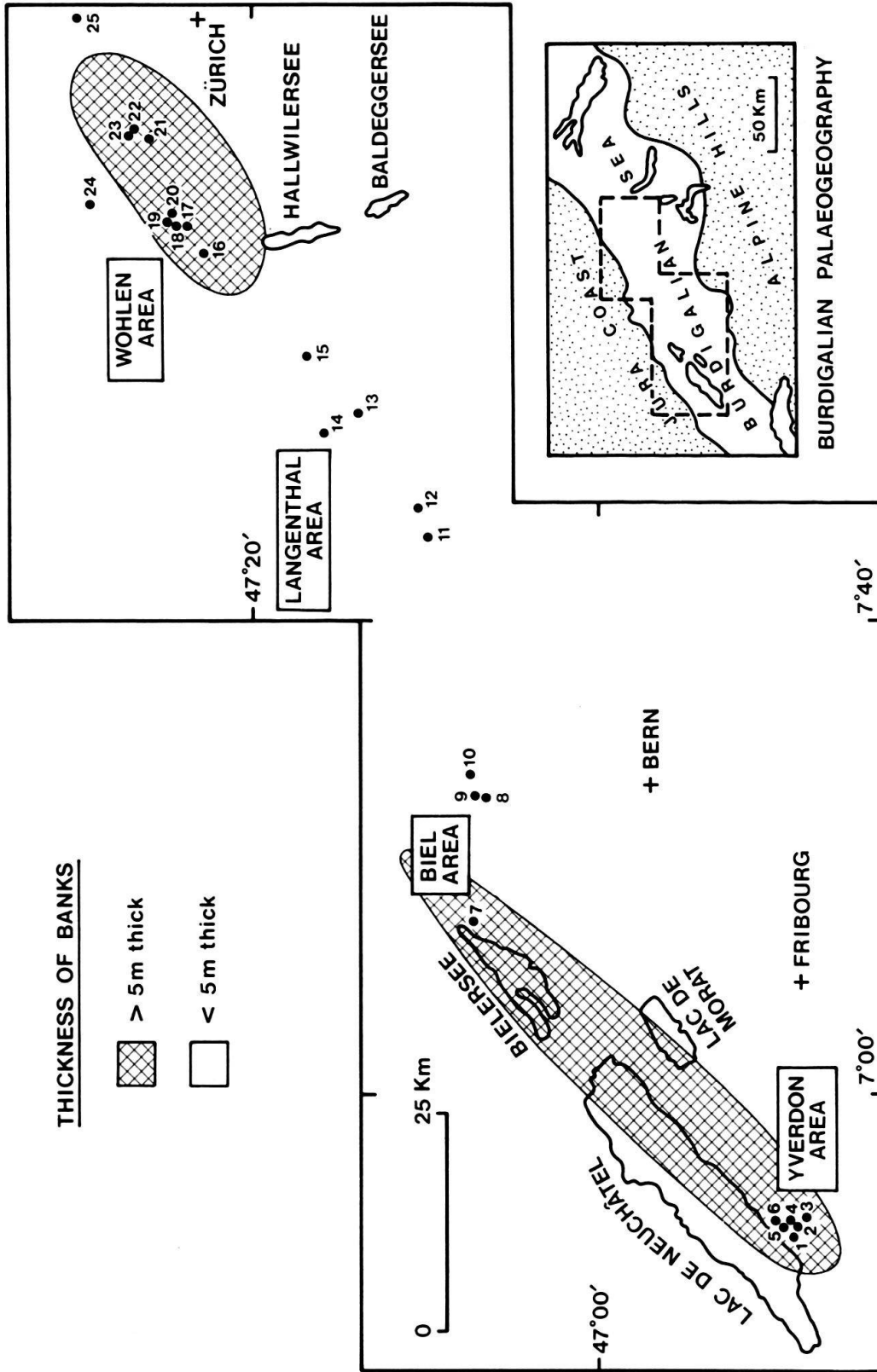

Fig. 5. Thickness of Muschelsandstein banks in the Molasse basin.

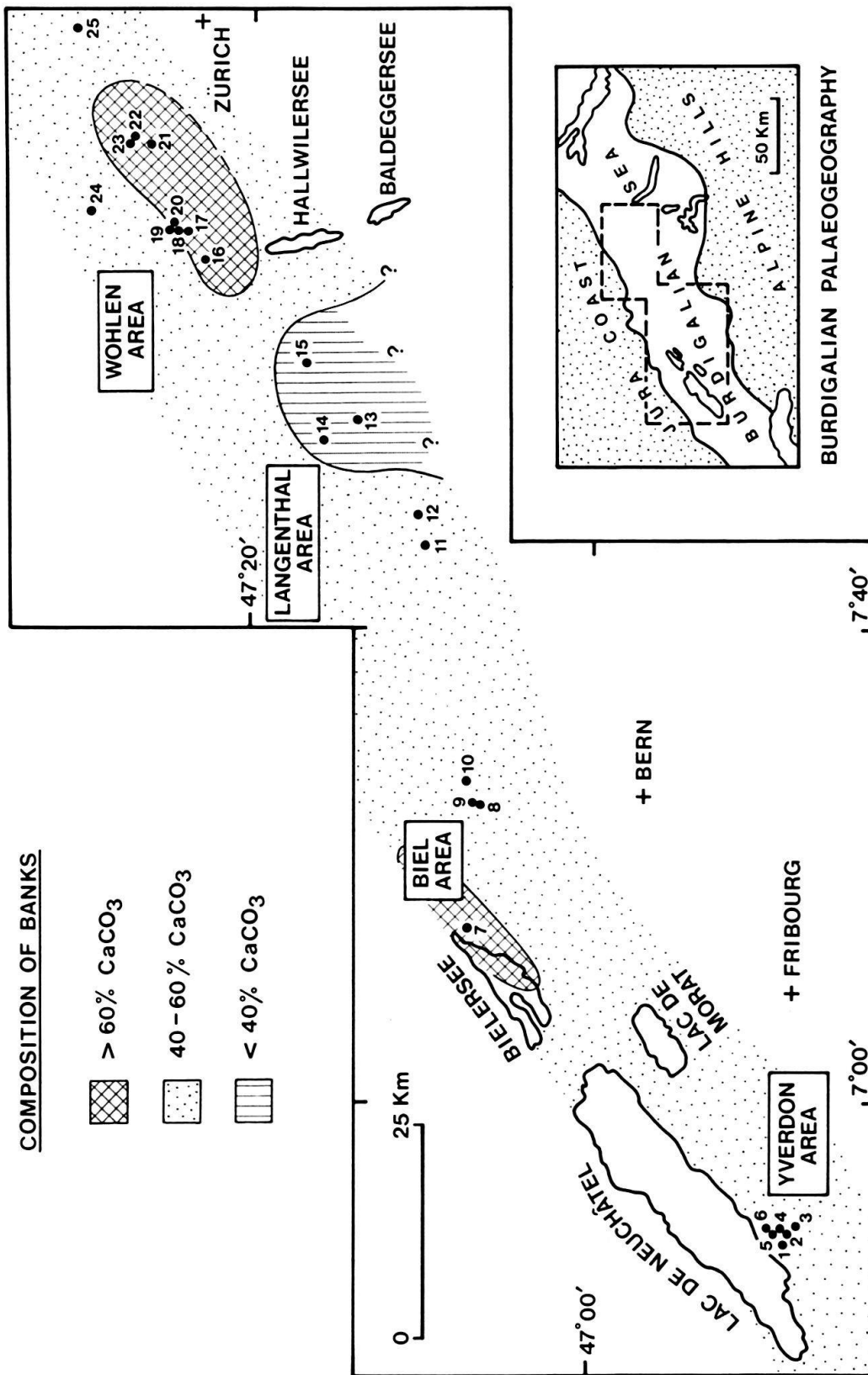

Fig. 6. Composition of Muschelsandstein banks in the Molasse basin.

“Grobsandstein”. They were deposited by a southwestward-flowing palaeocurrent system draining the Bohemian Massif (LEMCKE 1967, LEMCKE et al. 1953, WIESENENDER & MAURER 1958, FÜCHTBAUER 1954, 1964, and HOFMANN 1957, 1960, 1976). Alpine-derived detritus (chloritoid, blue sodic amphibole and epidote) contaminate this extra-Alpine assemblage of andalusite, topaz, large, dark brown staurolite and pink, faceted garnet.

The parent rocks of the blue amphibole and lawsonite were presumably the blueschists of Graubünden. Together with the pumpellyite (see also DIETRICH 1969), these minerals were probably introduced by the Hörnli fan (Fig. 4).

There are no indications of a drainage network of appreciable dimensions from the Jura Mountains to the north. Only calcareous grains and limestone pebbles were eroded and transported to the sea from this region.

3. Structure of the Muschelsandstein banks

The most suitable subdivision of the Muschelsandstein accumulations is into two compositional-structural types. These two types appear to correspond to the lithologies of RUMEAU (1954).

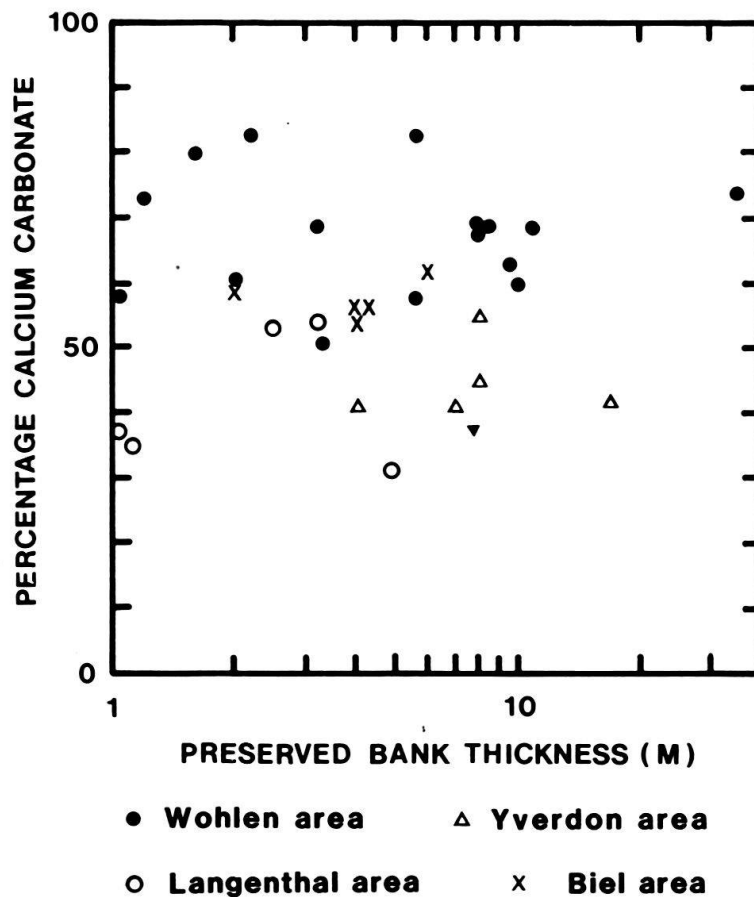

Fig. 7. Plot of calcium carbonate content versus preserved Muschelsandstein bank thickness. Note that banks of high steepness, principally in the Wohlen area, possess high CaCO₃ contents from the large shell fraction. Banks of low steepness, in the Langenthal area have low CaCO₃ contents.

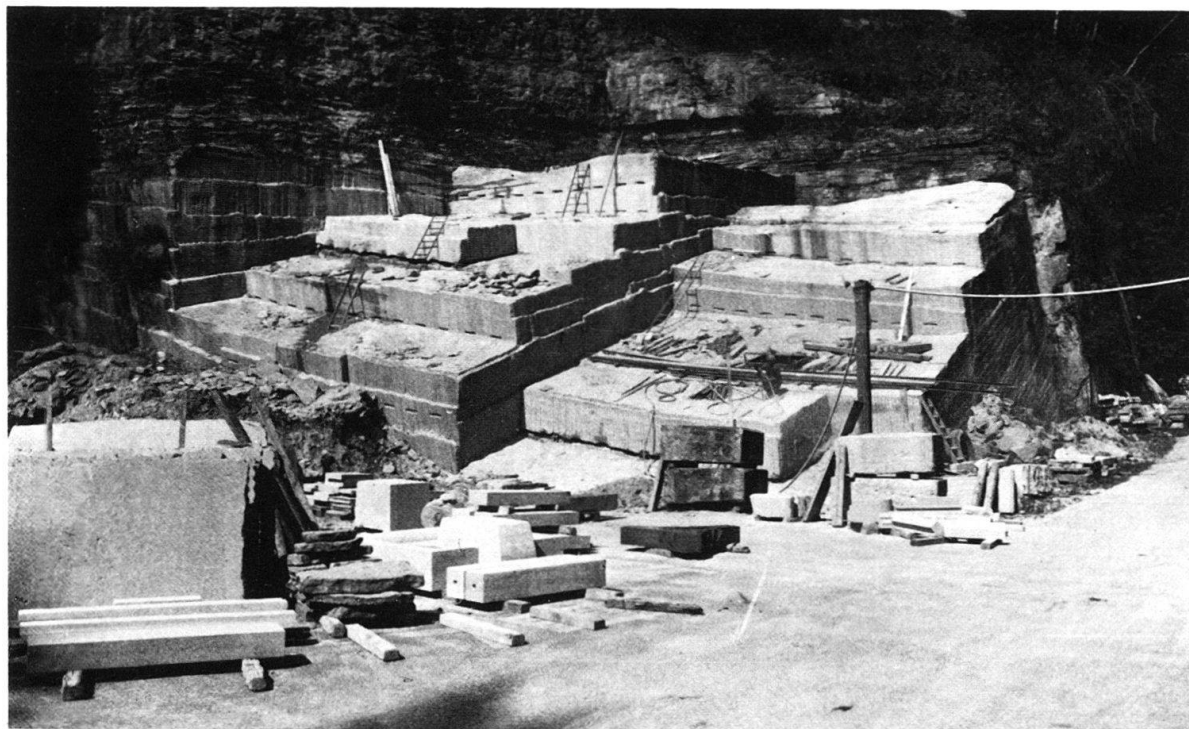

Fig. 8. The upper 16 m of the bank at Steinhof near Lenzburg (locality 17). Quarrymen are currently excavating the stone along foreset slopes.

1. Tall banks rich in bioclastic debris (coquinas) with a simple structure of moderate to high angle foresets.
2. Banks of variable size rich in finely fragmented bioclastic debris and siliciclastic material, often with low angle foresets or more complicated anatomies. This type is associated with deep sandstone-filled channels.

3.1 Banks of high steepness

These large banks (up to 35 m thick) contain high amounts of biogenic debris (Fig. 5, 6, 7) and are characterized by moderate to high angles of foreset dip. Thicknesses of individual foresets vary from about 10 cm to nearly 60 cm. The foresets are separated by fine sediment layers (mostly silt) generally less than 1 cm thick. Bivalves are disarticulated and are concentrated mostly in a hydrodynamically stable position on foreset slopes, clearly representing a death assemblage.

The bank at Steinhof near Lenzburg (35 m thick, 16 m of which are visible) represents the simplest possible structural type (Fig. 8). The well demixed foresets are inclined towards the southwest in the eastern part of the outcrop, but there is a progressive shift towards the northwest in the “downcurrent” part of the quarry (Fig. 9). There are no good indications of the paleo-elongation direction of the bank. The length of over 120 m of section indicates a migrating bedform in equilibrium with marine processes (see below).

Large banks are locally overlain by bipolar sandwaves or dunes, as at Steinhof. These bedforms exhibit a very regular alternation of coarse (msl-msu) and fine (vfsu-fsl) grain sizes within cross-sets (up to 40 cm thick) and are composed of smaller cyclical units with

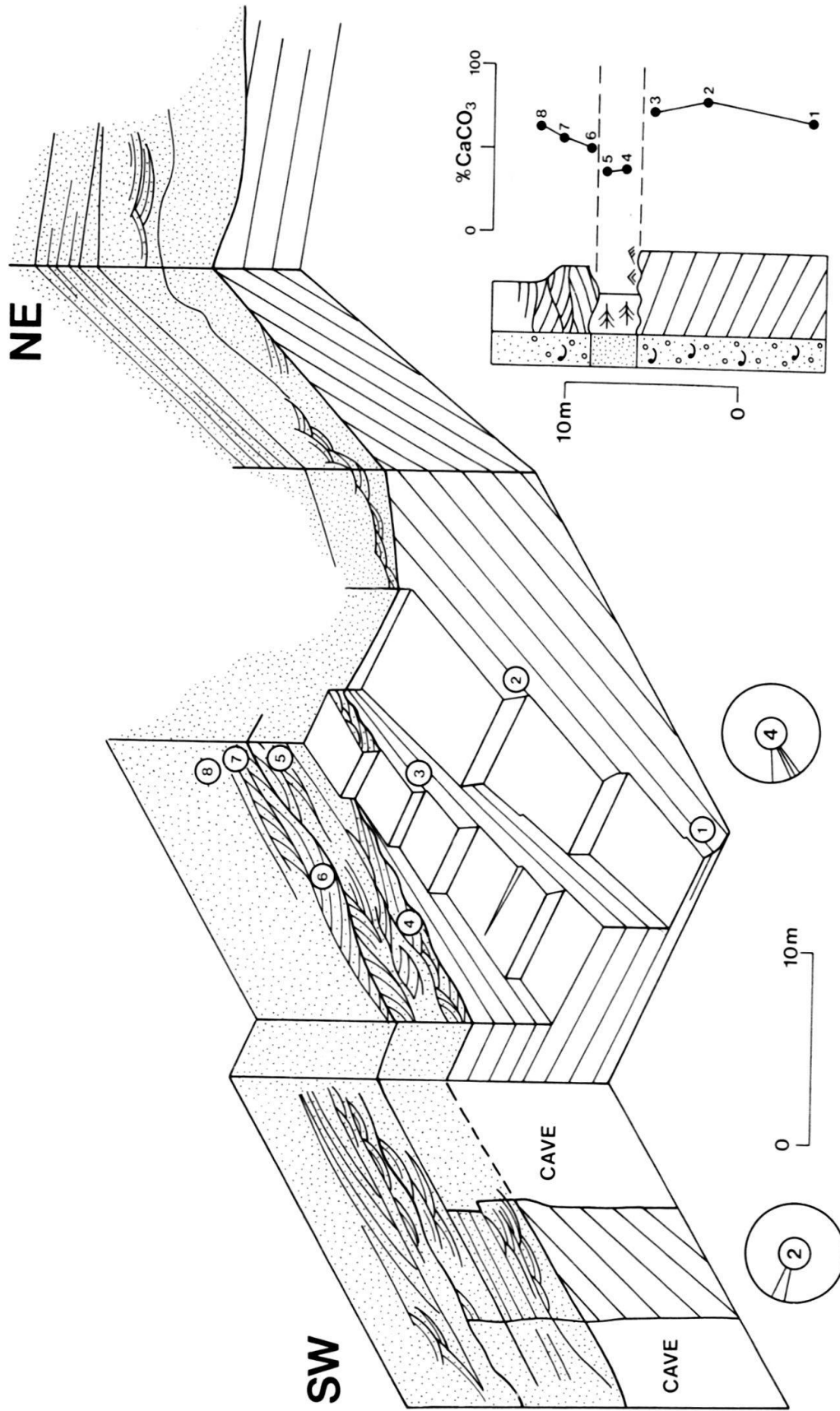

Fig. 9. Line interpretation of the Muschelsandstein bank and overlying deposits at Steinhof near Lenzburg (locality 17), with schematic vertical section showing $CaCO_3$ contents. Foreset azimuths are also shown.

a marked periodicity of 12 to 13 beds. Wave-generated, locally trochoidal, ripple marks, formed by waves advancing to the south, are common between individual sandwaves. The bipolarity, regular granulometric variation and cyclicity of these deposits suggests a tidal influence.

Banks at other localities are structurally more complex. At Eckwil near Mägenwil the bank comprises several distinct units (Fig. 10). The main body is composed of two units of moderate to steeply dipping foresets; a lower unit which is 5.50 m thick separated by an angular discordance from an upper which is 7.10 m thick. Foresets dip to the west or southwest. There is a shift in foreset azimuth from west in the northern part of the quarry to southwest in the southern part of the quarry.

An east- to southeastward-dipping unit (B) (1.70 m thick) is present on the eastern flank of the main body at Eckwil, resting erosively on older units. This unit with reversed orientation contains many fine grained interbeds, an abundance of highly fragmented *Scutella* debris and passes down-flank into large troughs with axes oriented approximately N-S.

In detail, the foresets are separated by small angular discordances which become more pronounced towards the toesets. Fine grained interbeds, consisting of parallel laminations of siltstones and very fine sandstones, are found near to the toesets of the individual units comprising the bank. Finely laminated interbeds also occur between groups of foresets.

The occurrence of cyclically arranged toesets is especially useful in interpreting depositional environments. Such cycles are clearly seen at Mägenwil Naturschutz where a large (12 m thick) bank wedges out towards the south. Southward dipping foresets are well developed in the N-S section but are represented by large, shallow troughs in the E-W section. Fine grained interbeds fill depressions between cross-sets. Individual groups of foresets become asymptotic towards the south and subdivide into sand/mud intercalations which are arranged in coarsening-up, fining-up (symmetrical) cycles, ideally of 27 or 28 beds, or fining-up (asymmetrical) cycles of up to 14 beds (Fig. 11, 12). Some cycles amalgamate by truncation at foreset toes. Near the top of some cycles are double sand layers separated by fine grained sediment. Near-symmetrical ripples, probably due to a superimposed unidirectional current on waves, move up the main foresets, but are concentrated near the toes where they are smaller in wavelength (see 4.3 for details).

The cycles preserved at the toesets of the bank at Mägenwil Naturschutz are of a similar type to those at Würenlos (see 3.2). The double sand layers observed near the tops of these cycles represent ebb and flood tide peak velocities whereas the intercalated fines were deposited during high tide (thick fine sediment layers) and low tide (thin fine sediment layers) slack water periods.

Other banks of high steepness with relatively simple structure occur in the Yverdon area and another excellent example occurs at Killwangen near Zürich (Fig. 13).

Steep banks are interpreted as the deposits of migrating sandwaves in equilibrium with reversing (tidal) flows. The moderate to high angle of foreset slope and relatively simple internal structure suggest that they formed under highly asymmetrical tides and belong to the Class IV of ALLEN (1981). The presence of steep foresets contradicts an origin as flow-parallel tidal ridges (CASTON 1981, MCCAVE & LANGHORNE 1982, STRIDE 1982). We are unaware at present of any convincing modern analogues to these very large, steep, shelly bedforms.

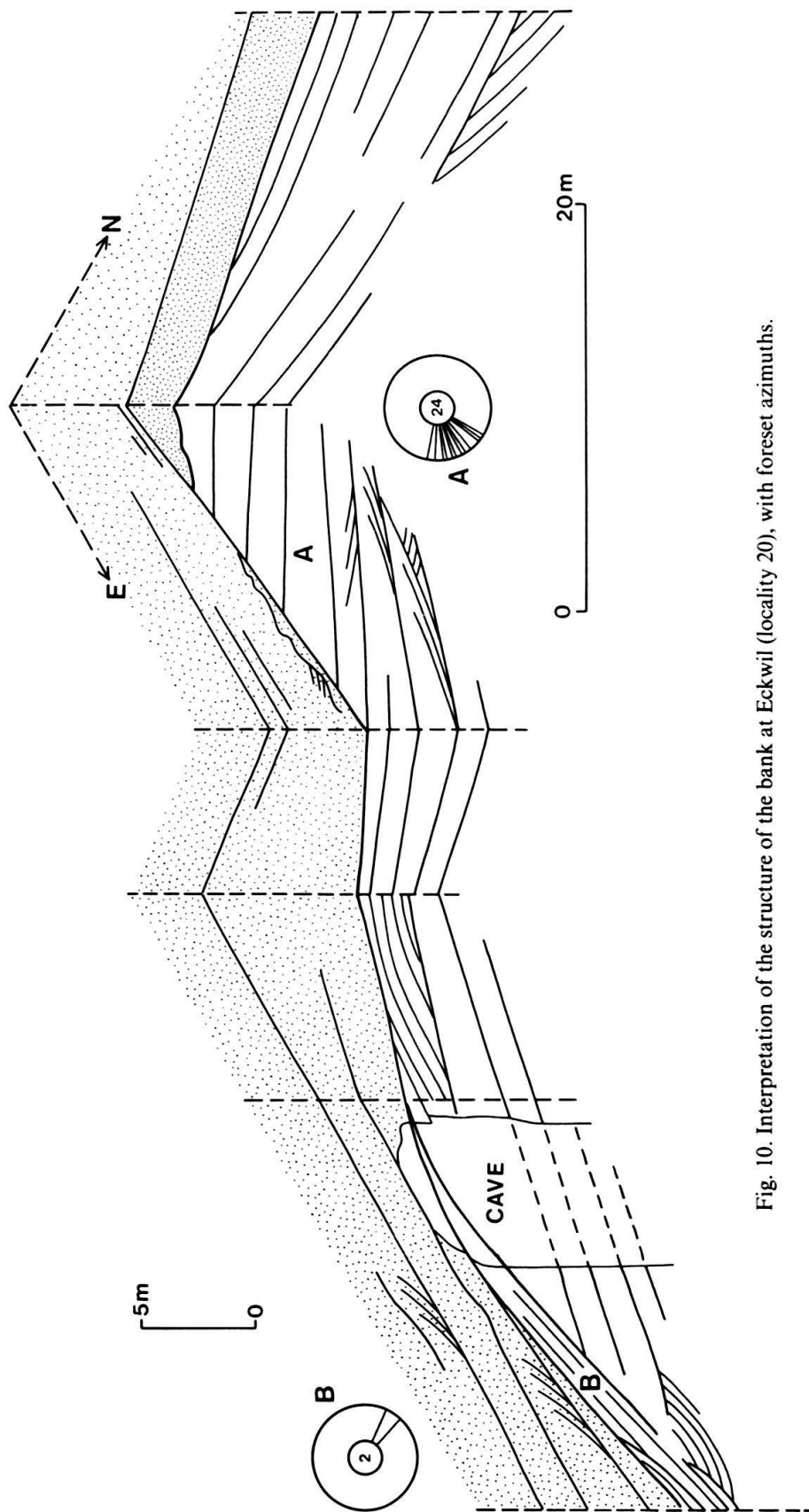

Fig. 10. Interpretation of the structure of the bank at Eckwil (locality 20), with foreset azimuths.

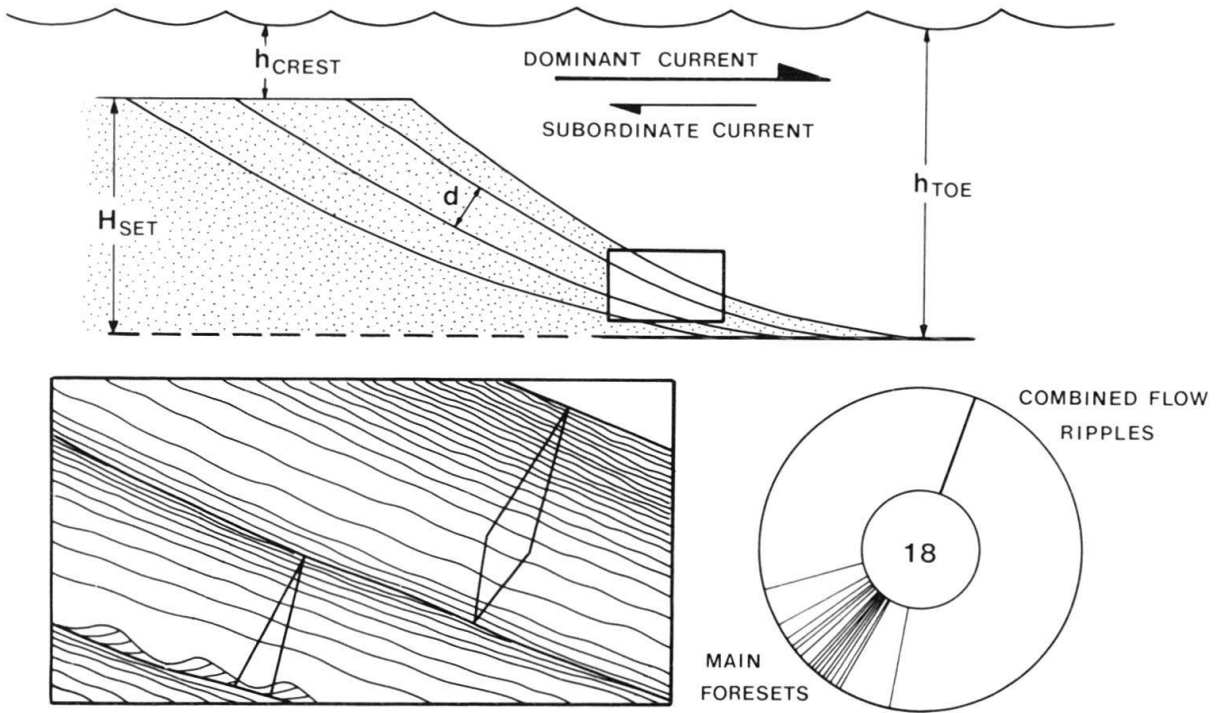

Fig. 11. Schematic diagram of the bank at Mägenwil Naturschutz (locality 19) with a detail of the structure of the cyclically-arranged toesets.



Fig. 12. Thinning-up packages of beds in the toesets of the bank at Mägenwil Naturschutz (locality 19).

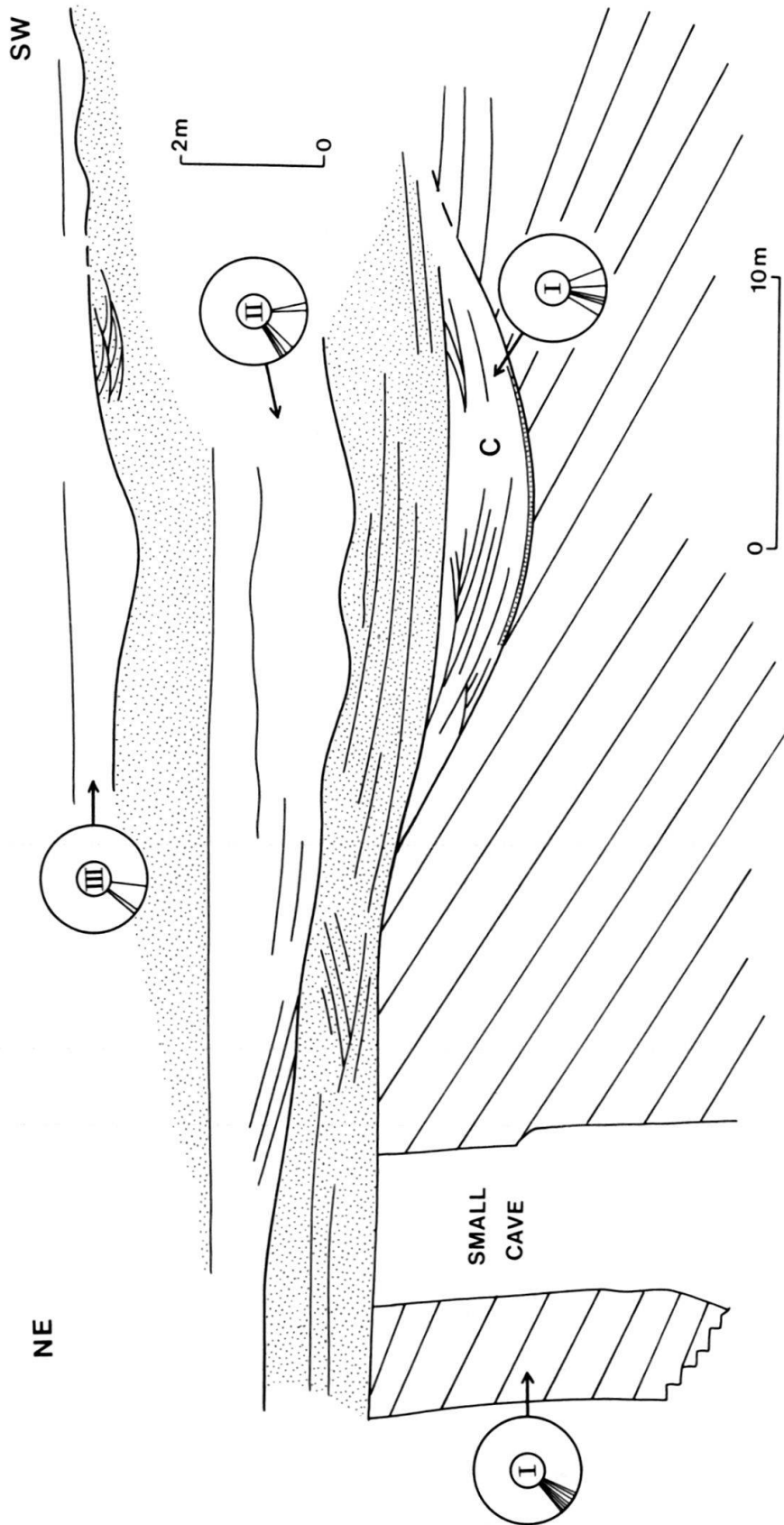

Fig. 13. A bank of high steepness (I) is incised by and overlain by channel bodies at Killwangen (locality 21).

3.2 Banks of low steepness

These banks are in general thinner than banks of high steepness and contain higher proportions of siliciclastic detritus (Fig. 5, 6, 7) together with much fragmented *Scutella*. The amount of dip of foresets is variable but in many cases is low in angle. The lateral transitions from Muschelsandstein bank into sandstone-filled channel is commonly observed.

Banks of low steepness also have cyclically arranged foresets. Near the southeastern extremity of the Würenlos Zelgli outcrop an exceptional section occurs comprising a lower bank (3.1 m thick) with high angle avalanche foresets dipping southwards (a bank of high steepness) and two banks at a higher level (both 2.2 m thick) composed of low angle foresets dipping north to northwest (Fig. 14). These foresets are locally organized in thinning-up cycles and pass toward their asymptotic bases into fine grained beds containing combined flow ripple marks. Groups of foreset have a pronounced cyclicity, mostly of thinning-up, fining-up type.

At the northwestern end of the Würenlos Zelgli locality a thick Muschelsandstein bank (greater than 8 m high) is overlain by a facies composed of cycles 30 to 45 m thick made of regularly alternating sandstone and shale laminations. This facies also occurs towards the southeast at Würenlos Zelgli where individual cycles can be linked with groups of foresets in the Muschelsandstein banks. The cycles are generally thinning-up in type and typically consist of a bipolar sandwave with internal flasers and reactivation surfaces overlain by wavy and lenticular bedding. The cycles have a cyclicity between 23 and 26 and locally between 10 and 14. Combined flow and wave ripple marks are common. The presence of bipolar sandwaves and systematically ordered cycles with bed periodicity approaching 14 and 28 strongly suggests the action of tides. Furthermore, the undoubted linkage of tidal cycles with groups of foresets in the Muschelsandstein banks demonstrates a tidal influence of bank growth.

Muschelsandstein banks are locally associated with deeply incised, often sandstone-filled channels, as at Turgi–Anzflue (locality 24), situated close to the western end of the Lägern–Albstein high. At the lowest stratigraphic level a 5 m thick Muschelsandstein unit passes southwards into a sandstone channel with spectacular dewatering structures. This is in turn incised by a second deep channel in the north with a near-vertical cut-bank oriented NE–SW (Fig. 15). At a slightly higher stratigraphic level a laterally persistent Muschelsandstein bank (level 2,2 m thick) with graded, low angle foresets (less than 5 cm thick) is again cut by a steeply incised channel. The channel-fill is a gravelly sandstone with oysters, intraclasts and Jura pebbles. A third Muschelsandstein bank (level 3) is present in the upper part of the section.

Sandwaves, locally displaying herring-bone cross-stratification, are ubiquitous in the Turgi section. They form the lower part of thinning-up cycles (up to 20 cm thick) identical to those seen at Würenlos Zelgli. Draped pause planes within sandwaves, bidirectional structures and systematic periodicity of cycles suggest tidal action.

At Langnau near Reiden (locality 13) a 4.8 m thick Muschelsandstein bank overlies a bipolar sandwave facies with local small pebble- and wood-lined channels. Some of the sandwaves show distinct periodicities in the thicknesses of their component foresets which probably reflect neap-spring variations of the tidal wave. Small foresets within the low-angle master bedding planes in the Muschelsandstein bank have the same orientation

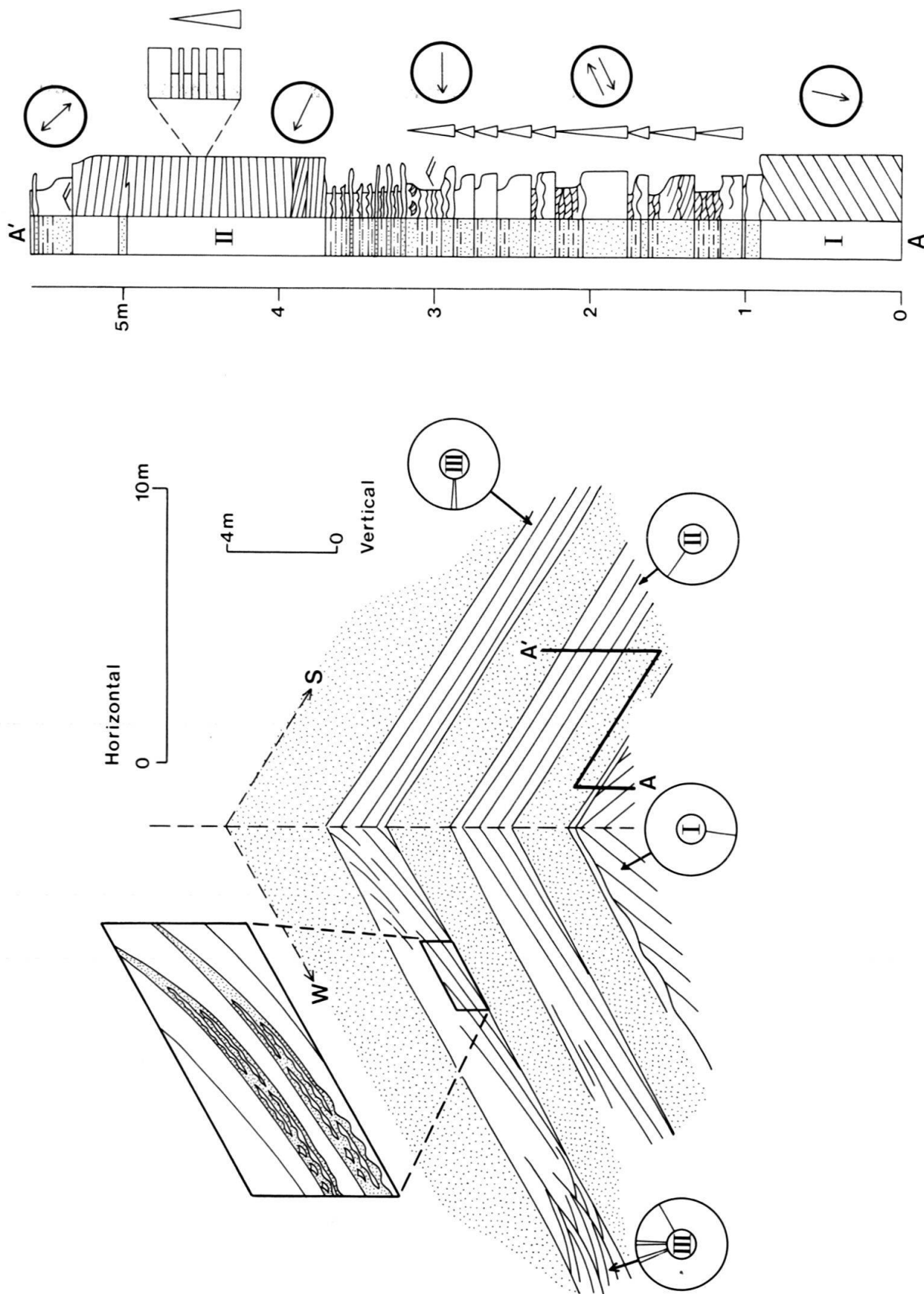

Fig. 14. Simplified sketch of three banks at Würenlos-Zelgli (locality 22) with detail of tosets, palaeocurrents and sedimentological log.

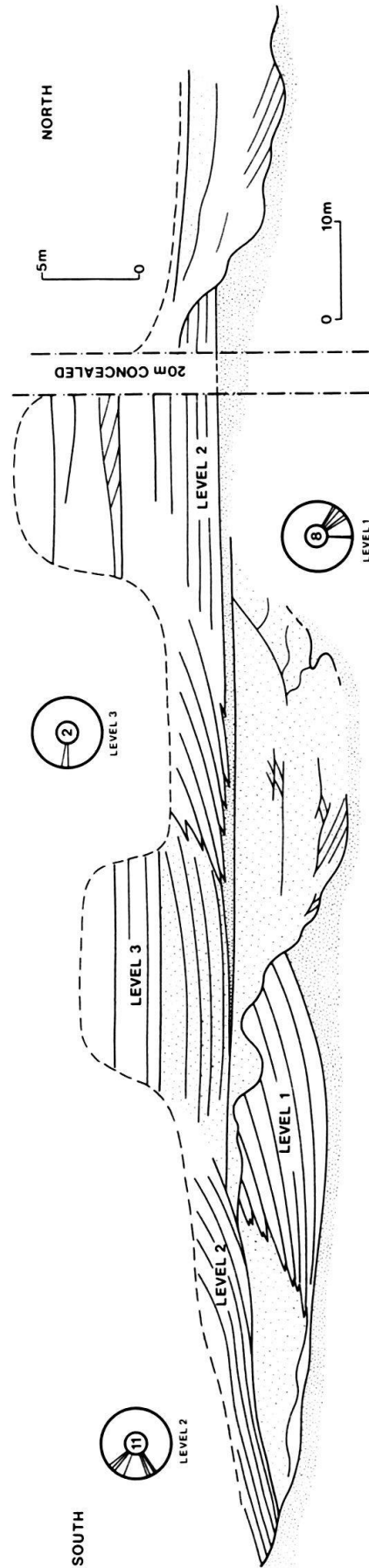

Fig. 15. Simplified sketch of Muschelsandstein banks and steeply incised channels at Anzflue-Turgi (locality 24).

as the dominant (ebb) current of the tidal sandwaves, and result from the migration of megaripples which covered the bank surface.

These gently-sloping banks are also interpreted as tidal sandwaves, but the generally low angle of foreset slope and the composite nature of cross-stratification suggest that they were formed under less asymmetrical tides (ALLEN 1982). They belong to the Class V of ALLEN (1981).

The palaeocurrents obtained from foresets of Muschelsandstein banks are given in Figure 16.

4. Mechanics of bank growth

Banks of high steepness and banks of low steepness both contain groups of foresets which can be traced towards their toes into cycles showing bed periodicities approaching 14 or 28, which suggests that each group was deposited in a 14-day neap-spring-neap tidal cycle. This confirms the semi-diurnal tidal regime demonstrated by ALLEN & HOMEWOOD (1984), and HOMEWOOD et al. (1985) from Burdigalian subtidal sandwaves in the vicinity of Fribourg, Switzerland. The groups of foresets show an analogous variation to the neap-spring bundle thickness variations of ancient and sub-Recent tidal sandwaves (BOERSMA 1969; VISSER 1980; J. R. L. ALLEN 1981a, b; HOMEWOOD & ALLEN 1981; ALLEN & HOMEWOOD 1984; YANG & NIO 1985).

4.1 Sediment transport rates

The rate of sediment transport over the Muschelsandstein banks is the factor controlling all other variables such as bank height, bank steepness and migration rate. Estimates of the 14-day averaged sediment transport rate can be obtained using the SIMONS et al. (1965) equation

$$Q_{sb} = \rho_s(1-\phi)V_s H/2+c \quad (1)$$

where ρ_s is sediment density, ϕ is porosity, V_s is the average speed of sandwave advance, H is bank height and c is a constant of integration equal to zero for a dune covered bed, assuming a triangular bedform cross section.

The average speed of bank advance can be found from

$$V_s = d/\sin\theta (14)(24)(60)^2 \quad (2)$$

where d is the thickness of groups of foresets, θ is foreset dip and the remainder of the denominator is the number of seconds in a 14-day neap-spring cycle.

The dry bulk density of the various banks is based on their CaCO_3 contents and a notional porosity of 40%. The low values of 14-day average sediment transport rates (Table) are considerably smaller than those in the channelized coastal zone studied by ALLEN & HOMEWOOD (1984), suggesting less confined offshore tidal flows.

4.2 The offshore wave climate

HOMEWOOD & ALLEN (1981), and ALLEN (1984) evaluated the wave climate of the Burdigalian sea based on wave ripple mark data from the marine facies of the Fribourg

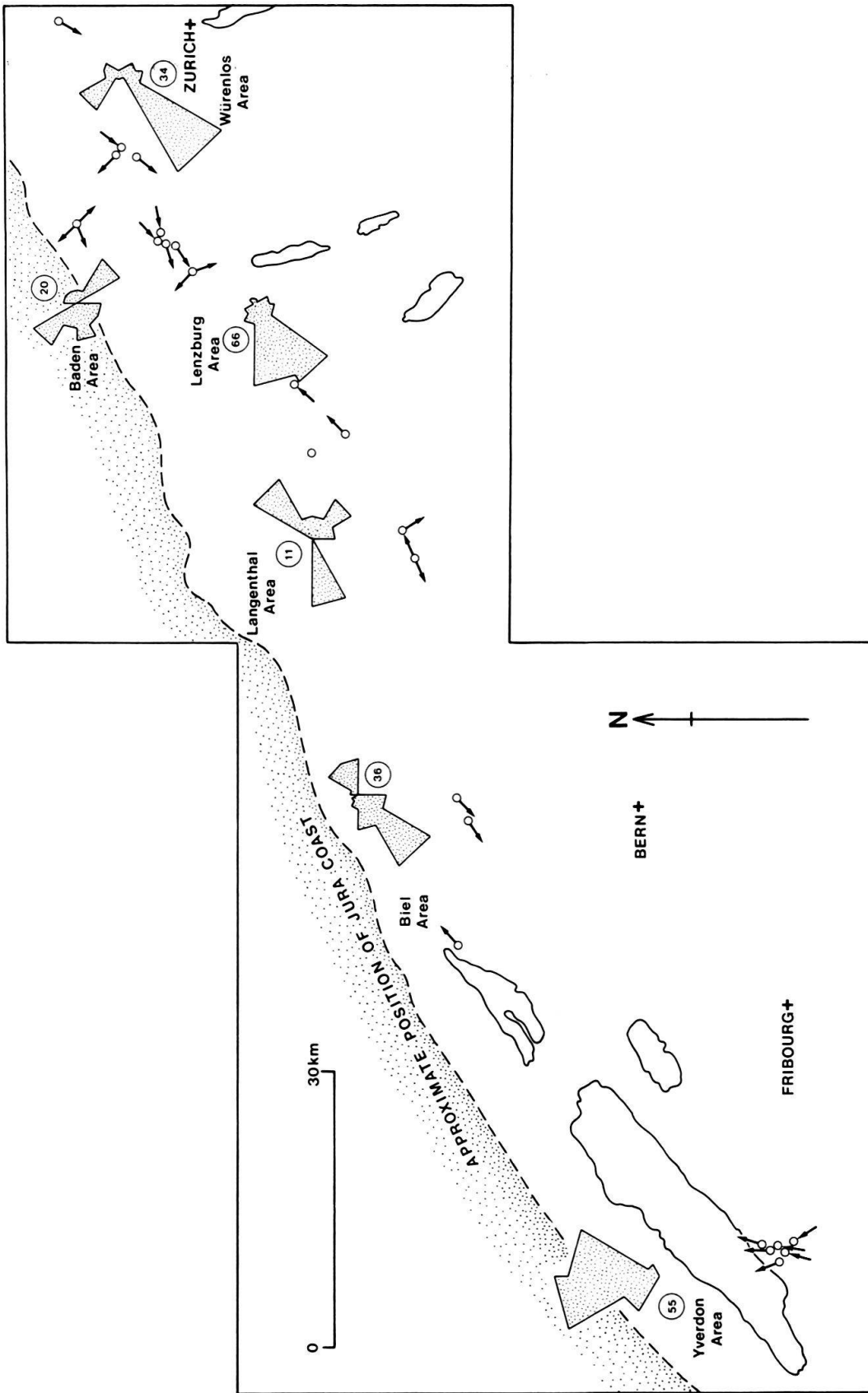

Fig. 16. Palaeocurrents from Muschelsandstein banks in the Molasse basin. Arrows are vector means from individual banks; palaeocurrent roses are shown for the Würenlos, Baden, Lenzburg, Langenthal, Biel and Yverdon areas.

Table: *Bedload sediment transport rates averaged over a neap-spring cycle for seven Muschelsandstein banks compared with data from the channellized coastal belt of ALLEN & HOMEWOOD (1984).*

Locality (No.)	H (m)	$q_s(1-\phi)$ (g cm ⁻³)	$\bar{V}_s \times 10^{-4}$ (cm sec ⁻¹)	\bar{Q}_{sb} (g cm ⁻¹ sec ⁻¹)
Mägenwil Naturschutz (19)	10.0	1.23	1.21	0.07
Lenzburg-Steinhof (17)	16.0 ⁺	1.15	0.41	0.04 ⁺
Würenlos-Zelgli (22)	8.0	1.18	1.79	0.08
Wildenstein (16)	7.0 ⁺	1.18	1.51	0.06 ⁺
Mägenwil-Eckwil (20)	8.7 ⁺	1.25	1.28	0.07
Turgi-Anzflue (24)	5.0	1.26	1.59	0.05
Killwangen (21)	6.7	1.9	0.21	0.008
Average net bedload transport rate of sandwave in channellized belt, Burdigalian Fribourg area				0.14

area. They concluded that wave periods were typically about 4 sec and significant wave heights less than 1 m. From this information HOMEWOOD & ALLEN (1981) speculated that the Burdigalian sea was of the order of 100 km wide in Switzerland, a figure in close agreement with traditional views on Miocene palaeogeography.

ALLEN (1984) analyzed the offshore wave climate by studying wave ripple marks on the flanks and tops of the Muschelsandstein banks. The reconstructed periods of formative waves were generally less than 3 sec, suggesting water depths of less than 10 m.

4.3 *The combined action of waves and currents*

The occurrence of near-symmetrical ripple marks at the toes of the Muschelsandstein banks provides corroborative evidence of the operation of reversing currents. Although the presence of near-symmetrical ripple marks at bank toes is a general feature, it is of particular significance at Mägenwil Naturschutz where the bank is in excess of 10 m high and the pertinent median grain size in the toesets is taken as 0.025 cm. Could these ripple marks have been produced by waves alone? The following theoretical approach suggests that waves alone were not likely to be responsible.

Assuming a reasonable wave period of approximately 4 sec, maximum near-bottom orbital velocity due to waves varies as a function of water depth and wave height according to Figure 17. Waves alone were capable of forming ripples ($U_o > U_{ot}$, see caption to Fig. 17 for details) in water depths of less than 10 m and, in fair weather, of less than 5 m. Since the bank is greater than 10 m high and in the absence of evidence for bank truncation at times of subaerial emergence, it is postulated that waves alone could not have been responsible for the formation of the near-symmetrical ripple marks at bank toes. Because the ripple marks possess steeper limbs facing the bank (due north), a reversed current superimposed upon wave oscillation is required, indicating a tidal control on sedimentary processes.

A similar result is obtained if wave period varies (Fig. 18). Unless wave periods were long, which is unlikely in a basin of limited fetch (NEUMANN 1953), water depths appear to be too deep to allow waves to be the only mechanism for ripple mark formation. Since the ripple marks are near-symmetrical in profile and possess low ripple steepness values (or vertical form index of BUCHER 1917) it is justifiable to infer combined flows and consequently water depths above the bank crest most likely fall in the region of 5 to 10 m. Within this zone above the bank crest, the finer grades of sediment would be permanently in

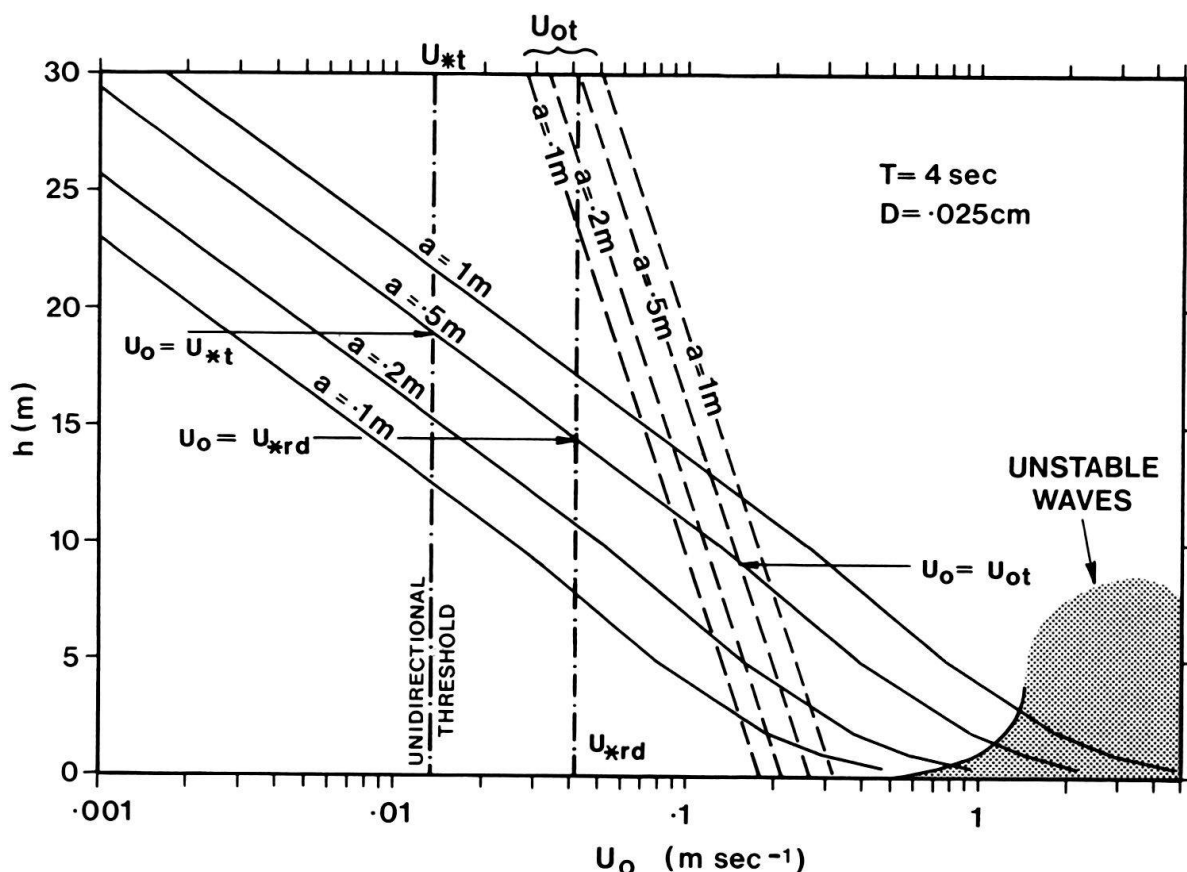

Fig. 17. Maximum near-bottom orbital velocity due to waves (U_o) as a function of water depth (h) and wave height (H), expressed as wave amplitude ($a = H/2$), for a constant wave period of $T = 4$ sec. Threshold orbital velocity for sediment movement (U_{ot}) derived from KOMAR & MILLER (1973). For ripple formation by waves alone, $U_o > U_{ot}$, implying water depths of less than 9 m for 1 m high waves. For combined flows, the dominance of steady currents over waves falls in the region $U_o < U_{*t}$ for threshold conditions and $U_o < U_{*rd}$ for the unidirectional ripple \rightarrow dune transition. U_{*t} , obtained from SHIELDS (1936) modified by VANONI (1974), U_{*rd} obtained from the Bagnold criterion in ALLEN & LEEDER (1980). Under 1 m high waves, steady flows are dominant in water depths of greater than 18 m (threshold conditions) and greater than 14 m where the unidirectional component is assumed to have a velocity equivalent to the ripple \rightarrow dune transition. Limits for stable waves according to MICHE (1944) and MCCOWAN (1894) rule out the possibility of occurrences in the extreme right of the figure (stippled area). Fetch limits from actualistic (BRETSCHNEIDER 1966, NEUMANN 1953, STEVENSON 1852 in HUTCHINSON 1957, SVERDRUP & MUNK 1947) and palaeoenvironmental studies (HOMEWOOD & ALLEN 1981) provide approximate upper bounds for wind-generated wave heights.

suspension under most wave conditions and therefore would be winnowed into deeper water between banks. Such a process of bank crest winnowing provides a natural limit to bank height, suggesting that banks grew to a maximum height dependent on local water depth and wave conditions.

There is some doubt as to whether bedform dimensions can be used to reconstruct palaeowater depths (STRIDE 1970, BELDERSON et al. 1982, ALLEN & HOMEWOOD 1984, p. 68). Assuming the Muschelsandstein banks to be essentially transverse, long lived equilibrium forms, their dimensions may scale on outer flow variables such as water depth (RICHARDS 1980) in a manner described by both YALIN (1972), and ALLEN (1970). Water depths above the bank mid points fall in the range of about 10 m to more than 40 m using YALIN (1972), and ALLEN (1970) and the bank heights found in the Table. The

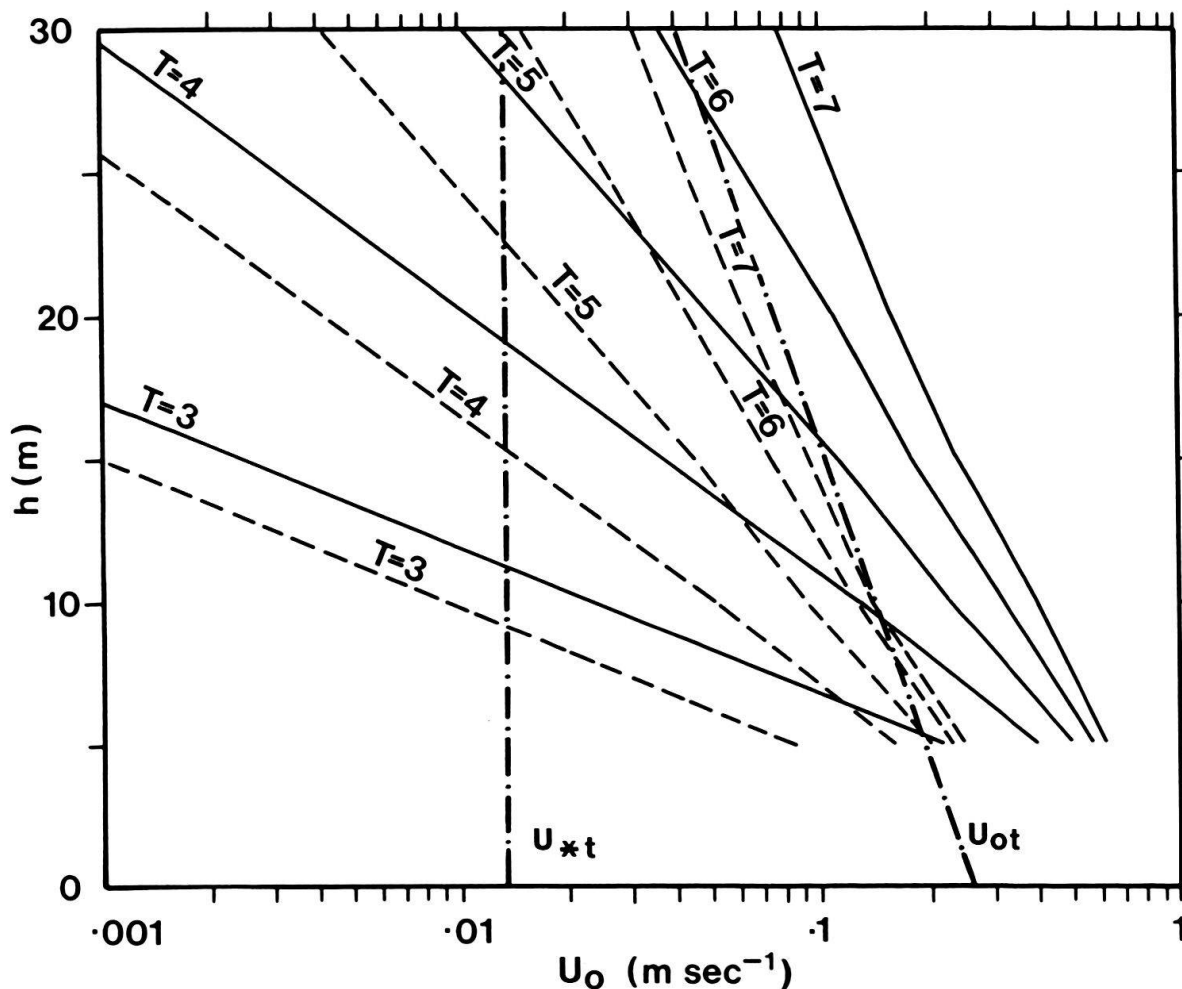

Fig. 18. Maximum near-bottom orbital velocity due to waves (U_o) as a function of water depth (h) and wave period (T) for 1 m high waves at the surface (solid lines) and 0.4 m high waves at the surface (broken lines). Orbital velocity at the threshold of sediment movement, U_{ot} , derived from KOMAR & MILLER (1973). Minimum water depths for the formation of wave ripple marks are strongly dependent on wave period, ranging between 5 m and 27 m for 1 m high waves with periods of 3 sec and 6 sec respectively. Fetch limits and field data (ALLEN 1984) suggest that wave periods were most likely in the region of 3 to 4 sec.

internal structure, superimposed bedforms and close association of the bank with tidal deposits and short wavelength wave ripple marks, which could only have been produced in very shallow waters, suggests that they originated under reversing flows with a limit to bank height provided by ambient wave conditions. The possible influence of large relative sea-level fluctuations during Miocene times must remain a subject of future research.

5. Sediment dispersal patterns and palaeogeography

The spatial distribution of heavy minerals (Fig. 3), size and composition of the offshore banks (Fig. 5 and 6) and palaeocurrents (Fig. 16) can be integrated into the following dynamic palaeogeography (Fig. 19).

Material eroded from the Western Alps was incorporated into a tidal transport path acting essentially as a closed cell between Lake Geneva and the Napf fan in the Langenthal area. Large, steep banks with high carbonate contents accumulated under

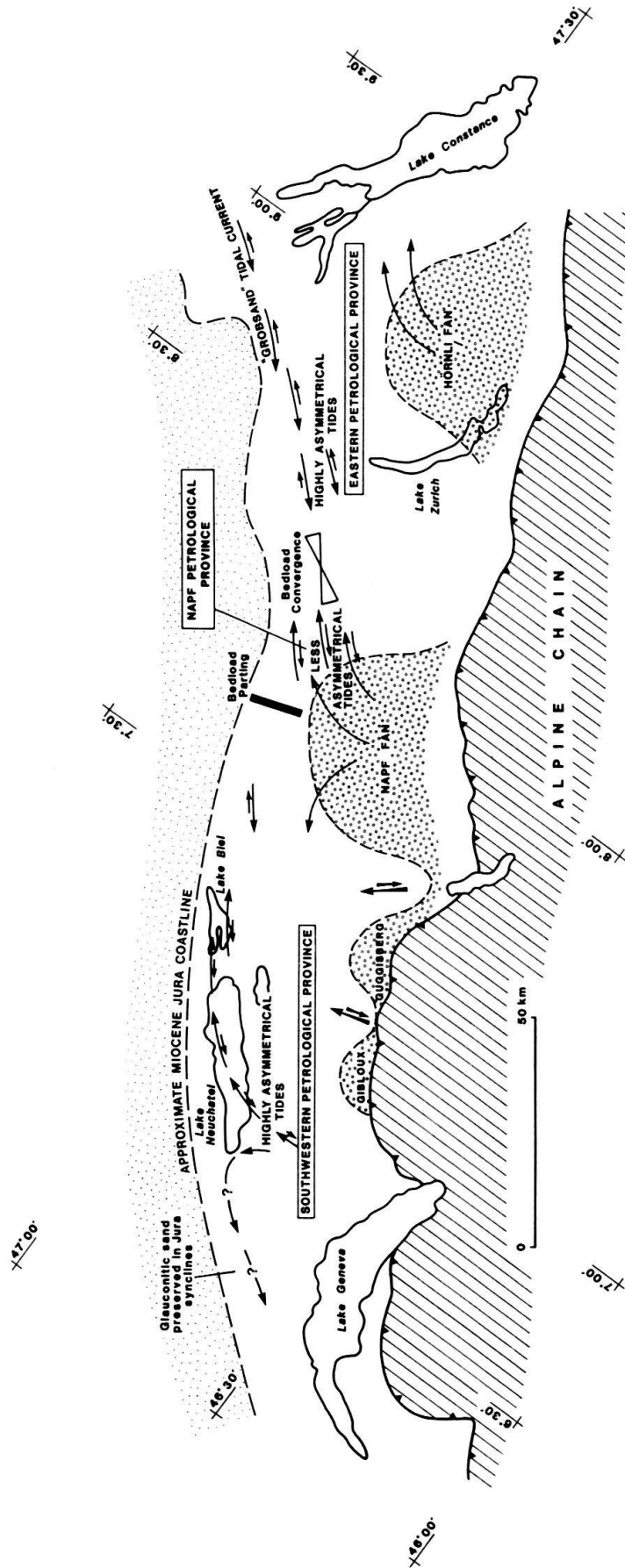

Fig. 19. Dynamic palaeogeography of the open Burdigalian seaway.

highly asymmetrical tides close to the Jura shoreline in the Broye area. The area at the eastern tip of Lake Biel may have been a zone of bedload convergence in Burdigalian times.

The intrusion of the Napf fan into the Burdigalian seaway had several profound effects. Firstly, it contaminated the offshore zone with siliciclastic detritus and flooded the heavy mineral association with epidote. Secondly, it was responsible for the location of a bedload parting across the seaway, separating the southwestern tidal circulation cell from an eastern cell. Within the zone of constriction north of the Napf fan, smaller and less steep banks were fashioned by less asymmetrical tides. The smaller time-velocity asymmetry prevented the winnowing out of sand from the pebbly and shelly framework of the banks. Geostrophic effects probably aided the predominantly eastward dispersal of Napf-derived sediments.

The eastern cell received detritus from the topaz-andalusite-rich source of the Bohemian Massif as well as from the Napf and Hörnli fans. Highly asymmetrical tidal currents transported eastern-derived material along the northern shore of the Burdigalian seaway. The region of Lenzburg was a possible zone of bedload convergence. Here, huge, steep banks rich in bioclastic debris and relatively uninfluenced by the siliciclastics of the Napf fan accumulated.

The Burdigalian seaway opened to the Tethys and eventually to the central Atlantic through straits in the region of Haute Savoie (Fig. 1). The ocean tidal wave undoubtedly entered the Swiss basin from this southwesterly direction, becoming progressively amplified by a narrowing and shallowing of the shelf sea. Meso- to macrotidal conditions therefore prevailed in western Switzerland (HOMEWOOD & ALLEN 1981). The existence of narrow straits in the southwest would have promoted vigorous longitudinal tidal currents in the basin, enhancing time-velocity asymmetries and allowing large steep shelly bedforms to be constructed. Much further work is required to refine this palaeogeographical picture.

Acknowledgments

This work was carried out as part of Swiss National Science Foundation Project 2.242-0.79. We are grateful to H. Haas for sample preparation, M. Millen for draughting and P. Westall for typing.

REFERENCES

- ALLEN, J. R. L. (1970): *Physical Processes of Sedimentation*. – George Allen and Unwin, London.
- (1980): Sand waves: a model of origin and internal structure. – *Sediment. Geol.* 26, 281–328.
- (1982a): Simple models for the shape and symmetry of tidal sandwaves: (3) dynamically stable asymmetrical equilibrium forms without flow separation. – *Marine Geol.* 48, 51–74.
- (1982b): Mud drapes in sandwave deposits: a physical model with application to the Folkestone Beds (Early Cretaceous, southeast England). – *Phil. Trans. r. soc. London (A)* 306, 291–345.
- ALLEN, J. R. L., & LEEDER, M. R. (1980): Criteria for the instability of upper stage plane beds. – *Sedimentology* 27, 209–218.
- ALLEN, P. A. (1984): Reconstruction of ancient sea conditions with an example from the Swiss Molasse. In: GREENWOOD, B., & DAVIES, R. A., Jr. (Ed.): *Hydrodynamics and Sedimentation in Wave-Dominated Coastal Environments* (p. 455–473). – *Marine Geol.* 60.
- ALLEN, P. A., & HOMEWOOD, P. (1984): Evolution and mechanics of a Miocene tidal sandwave. – *Sedimentology* 31, 63–81.

- BECKER, F. (1972): Géologie de la région du lac de Morat entre la Vallée de la Sarine et le lac de Neuchâtel. – Ph.D. thesis Univ. Fribourg.
- BELDERSEN, R. H., JOHNSON, M. A., & KENYON, N. H. (1982): Bedforms. In: STRIDE, A. H. (Ed.): Offshore Tidal Sands: Processes and Deposits (p. 27–57). – Chapman and Hall, London.
- BERTRAND, J. (1970): Etude pétrographique des ophiolites et des granites du flysch des Gêts (Haute-Savoie, France). – Arch. Sci. Genève 23, 273–542.
- BOCQUET, J., DAL PIAZ, G. V., HUNZIKER, J. C., MARTINOTTI, G., & PÊCHER, A. (1978): Metamorphic map of the Alps, 1:1,000,000. – Explanatory text. Leiden–Unesco, Paris, p. 181–242.
- BOERSMA, J. R. (1969): Internal structure of some tidal megaripples on a shoal in the Westerschelde estuary, The Netherlands. – Geol. en Mijnb. 48, 409–414.
- BRETSCHNEIDER, C. L. (1966): Wave generation by wind, deep and shallow water. In: IPPEN, A. T. (Ed.): Estuary and Coastline Hydrodynamics (p. 133–196). – McGraw-Hill, New York.
- BUCHER W. H. (1919): On ripples and related sedimentary surface forms and their palaeogeographic interpretation. – Amer. J. Sci. 47, 149–210, 241–269.
- BÜCHI, U. P. (1950): Zur Geologie und Paläogeographie der südlichen mittelländischen Molasse zwischen Toggenburg and Rheintal. – Ph. D. thesis Univ. Zürich.
- (1957): Zur Gliederung des Burdigalien im Kanton Aargau. – Bull. Ver. schweiz. Petroleum-Geol. u. -Ing. 23/65, 33–40.
- BÜCHI, U. P., & HOFMANN, F. (1960): Die Sedimentationsverhältnisse zur Zeit der Muschelsandsteine und Grobkalke im Gebiet des Beckennordrandes der Oberen Meeresmolasse zwischen Aarau und Schaffhausen. – Bull. Ver. schweiz. Petroleum-Geol. u. -Ing. 27, 11–22.
- BÜCHI, U. P., & WIENER G. (1967): Phosphatkugeln im Muschelsandstein des Oberaargau, Kt. Bern. – Bull. Ver. schweiz. Petroleum-Geol. u. -Ing. 34/85, 17–28.
- CASTON, G. F. (1981): Potential gain and loss of sand by some sand banks in the Southern Bight of the North Sea. – Marine Geol. 41, 239–250.
- DIETRICH, V. (1969): Die Ophiolithe des Oberhalbsteins (Graubünden) und das Ophiolithmaterial der ostschweizerischen Molasseablagerungen, ein petrographischer Vergleich. – Herbert Lang & Cie AG, Bern.
- FISCHER, H. (1983): K-Ar- und Rb-Sr-Altersbestimmungen an Glaukoniten der Helvetischen Kreide, des Tertiärs and des Oberen Jura sowie Geologie des Nord-Pilatus. – Unpubl. Diploma thesis, Univ. Zürich.
- FÜCHTBAUER, H. (1954): Transport und Sedimentation der westlichen Alpenvorlandmolasse. – Heidelb. Beitr. Mineral. Petrogr. 4, 26–53.
- (1964): Sedimentpetrographische Untersuchungen in der älteren Molasse nördlich der Alpen. – Eclogae geol. Helv. 57, 157–298.
- (1967): Die Sandsteine in der Molasse nördlich der Alpen. – Geol. Rdsch. 56, 266–300.
- GASSER, U. (1966): Sedimentpetrographische Untersuchungen in der äusseren Zone der subalpinen Molasse des Entlebuch (Kt. Luzern). – Eclogae geol. Helv. 59, 723–772.
- GERBER, M. E. (1982): Geologie des Berner Sandsteins (Das Burdigalien zwischen Sense und Langete, Kanton Bern). – Unpubl. Ph.D. thesis, Univ. Bern.
- GILLIÉRON, V. (1885): Description géologique des territoires de Vaud, Fribourg et Berne. – Matér. Carte géol. Suisse 18.
- HOFMANN, F. (1957): Untersuchungen in der subalpinen und mittelländischen Molasse der Ostschweiz. – Eclogae geol. Helv. 50, 289–322.
- (1960): Materialherkunft, Transport und Sedimentation im schweizerischen Molassebecken. – Jb. St. Gall. natw. Ges. 76, 5–28.
- (1976): Überblick über die geologische Entwicklungsgeschichte der Region Schaffhausen seit dem Ende der Jurazeit. – Bull. Ver. schweiz. Petroleum-Geol. u. -Ing. 42, 1–16.
- HOMEWOOD, P., & ALLEN, P. A. (1981): Wave-, tide- and current-controlled sandbodies of Miocene Molasse, western Switzerland. – Bull. amer. Assoc. Petroleum Geol. 65, 2534–2545.
- HOMEWOOD, P., ALLEN, P. A. & YANG, L.-S. (1985): Palaeotidal range estimates from the Miocene Swiss Molasse. – Int. Ass. Sedimentologists, 6th Europ. Regional Meeting, Abstr. p. 200–201.
- HUTCHINSON, E. G. (1957): A Treatise on Limnology. – John Wiley & Sons, New York.
- KOMAR, P. D., & MILLER, M. C. (1973): The threshold of sediment movement under oscillatory water waves. – J. sediment. Petrol. 43, 1101–1110.
- LEMCKE, K. (1967): Zur Paläogeographie der Glassande in der subalpinen Molasse Südbayerns. Geol. Rdsch. 56, 262–266.
- (1981): Das heutige geologische Bild des deutschen Alpenvorlandes nach drei Jahrzehnten Öl- und Gasexplo-

- ration. – *Eclogae geol. Helv.* 74, 1–18.
- LEMCKE, K., VON ENGELHARDT, W., & FÜCHTBAUER, H. (1953): Geologische und sedimentpetrographische Untersuchungen im Westteil der ungefalteten Molasse des süddeutschen Alpenvorlandes. – *Beih. Geol. Jb. (Hanover)* 11.
- MANGE-RAJETZKY, M. A., & OBERHÄNSLI, R. (1982): Detrital lawsonite and blue sodic amphibole in the Molasse of Savoy, France and their significance in assessing Alpine evolution. – *Schweiz. mineral. petrogr. Mitt.* 62, 415–436.
- MATTER, A. (1964): Sedimentologische Untersuchungen im östlichen Napfgebiet (Entlebuch–Tal der Grossen Fontanne, Kt. Luzern). – *Eclogae geol. Helv.* 57, 315–428.
- MAURER, H. (1983): Sedimentpetrographische Analysen an Molasseabfolgen der Westschweiz. – *Jb. Geol. Bundesanst. Wien* 126, 23–69.
- MAURER, H., FUNK, H., & NABHOLZ, W. (1978): Sedimentpetrographische Untersuchungen an Molasseablagerungen der Bohrung Linden-1 und ihrer Umgebung (Kt. Bern). – *Eclogae geol. Helv.* 71, 497–515.
- MAURER, H., GERBER, M. E., & NABHOLZ, W. (1982): Sedimentpetrographie und Lithostratigraphie der Molasse im Einzugsgebiet der Langete (Aarwangen–Napf, Oberaargau). – *Eclogae geol. Helv.* 5, 381–413.
- MCCAVE, I. N., & LANGHORNE, D. N. (1982): Sand waves and sediment transport around the end of a tidal sand bank. – *Sedimentology* 29, 95–110.
- MCCOWAN, J. (1894): On the highest wave of permanent type. – *Phil. Mag.* 5, 351–357.
- MICHE, R. (1944): Undulatory movements of the sea in constant and decreasing depth. – *Ann. Ponts et Chaussées*, May/June/July/August, 25–78, 131–164, 270–292, 369–406.
- MOOS, A. VON (1935): Sedimentpetrographische Untersuchungen an Molassesandsteinen. – *Schweiz. mineral. petrogr. Mitt.* 15, 169–265.
- NEUMANN, G. (1953): On ocean wave spectra and a new way of forecasting wind-generated sea. – *Tech. Memo. U.S. Army Corps Engrs., Beach Erosion Board* 43.
- ODIN, G. S., & MATTER, A. (1981): De glauconiarum origine. – *Sedimentology* 28, 611–642.
- PETTIJOHN, F. J. (1941): Persistence of heavy minerals and geologic age. – *J. Geol.* 49, 610–625.
- (1975): *Sedimentary Rocks*. – Harper & Row, New York.
- RICHARDS, J. K. (1980): The formation of ripples and dunes on an erodible bed. – *J. Fluid Mech.* 99, 597–618.
- RUMEAU, J.-L. (1954): *Géologie de la région de Payerne*. – Crépin-Leblond, Paris.
- RUTTE, E. (1952): Grobsand und Muschelsandsteine in der miozänen Meeresmolasse des nordwestlichen Bodenseegebietes. – *N. Jb. Geol. Paläont.* 1952/7, 295–304.
- SCHREINER, A. (1966): Zur Stratigraphie der Oberen Meeresmolasse zwischen der Oberen Donau und dem Überlinger-See (Bad.-Württemb.) – *Jber. Mitt. oberrh. geol. Ver. [N. F.]* 48, 91–104.
- SCHWAB, R. F. (1960): Geologische Untersuchungen in der Molasse der Umgebung von Biel (Kanton Bern). – Keller, Winterthur.
- SHIELDS, A. (1936): Anwendung der Ähnlichkeitsmechanik und der Turbulenzforschung auf die Geschiebepbewegung. – *Mitt. preuss. Versuchsanst. f. Wasser-, Erd- und Schiffbau Berlin* 26.
- SIMONS, D. B., RICHARDSON, E. V., & NORDIN, C. F. (1965): Bedload equation for ripples and dunes. – *Prof. Pap. U.S. geol. Surv.* 462-4.
- STAUB, R. (1934): Grundzüge und Probleme alpiner Morphologie. – *Denkschr. schweiz. natf. Ges.* 69/1.
- STRIDE, A. H. (1970): Shape and size trends for sandwaves in a depositional zone of the North Sea. – *Geol. Mag.* 107, 469–477.
- (Ed.) (1982): *Offshore Tidal Sands: Processes and Deposits*. – Chapman and Hall, London.
- STUDER, B. (1825): *Beiträge zu einer Monographie der Molasse*. – Jenni, Bern.
- SVERDRUP, H. U., & MUNK, W. J. (1946): Empirical and theoretical relations between wind, sea and swell. – *EOS, Trans. amer. geophys. Union* 28, 823–927.
- TRÜMPY, R. (1980): *Geology of Switzerland, a guide-book. Part A: An outline of the geology of Switzerland*. – Wepf & Co., Basel.
- VAN DER LINDEN, W. J. M. (1963): Sedimentary structures and facies interpretation of some Molasse deposits, Sense–Schwarzwasser area, Canton Bern, Switzerland. – *Geologica ultraiect.* 12.
- VANONI, V. A. (1964): Measurements of critical shear stress for entraining fine sediment in a boundary layer. – *Calif. Inst. Techn., W. M. Keck – Labor., Hydraul. Water Res. Rep.*, KH-R-7.
- VERNET, J.-P. (1957): Etude pétrographique des sédiments argilleux oligo-miocènes de la molasse de la région de Lausanne. – *Rev. Inst. franç. Pétrole* 12, 481–488.
- VISSER, M. J. (1980): Neap-spring cycles reflected in Holocene subtidal large scale bedform deposits: a preliminary note. – *Geology* 8, 543–546.

- WERNER, J. (1966): Ergebnisse der Auswertung von Flachbohrungen im Bereich des Grobsandzuges der Oberen Meeresmolasse (Gebiet Stockach-Pfullendorf). – Jber. u. Mitt. oberrh. geol. Ver. [N.F.] 48, 105–120.
- WIESENENDER, H., & MAURER, I. (1958): Ursachen der räumlichen und zeitlichen Änderung des Mineralbestandes der Sedimente des Wiener Beckens. – *Eclogae geol. Helv.* 51, 1155–1172.
- YALIN, M. S. (1972): *Mechanics of Sediment Transport*. – Pergamon Press, New York.
- YANG, C. S., & NIO, S. D. (1985): The estimation of palaeohydrodynamic processes from subtidal deposits using time series analysis methods. – *Sedimentology* 32, 41–58.

Manuscript received 1 April 1985

Revision accepted 7 May 1985

