

Prefabrication of main elements for long bridges

Autor(en): **Fries, Carsten**

Objektyp: **Article**

Zeitschrift: **IABSE reports = Rapports AIPC = IVBH Berichte**

Band (Jahr): **64 (1991)**

PDF erstellt am: **22.09.2024**

Persistenter Link: <https://doi.org/10.5169/seals-49333>

Nutzungsbedingungen

Die ETH-Bibliothek ist Anbieterin der digitalisierten Zeitschriften. Sie besitzt keine Urheberrechte an den Inhalten der Zeitschriften. Die Rechte liegen in der Regel bei den Herausgebern.

Die auf der Plattform e-periodica veröffentlichten Dokumente stehen für nicht-kommerzielle Zwecke in Lehre und Forschung sowie für die private Nutzung frei zur Verfügung. Einzelne Dateien oder Ausdrucke aus diesem Angebot können zusammen mit diesen Nutzungsbedingungen und den korrekten Herkunftsbezeichnungen weitergegeben werden.

Das Veröffentlichen von Bildern in Print- und Online-Publikationen ist nur mit vorheriger Genehmigung der Rechteinhaber erlaubt. Die systematische Speicherung von Teilen des elektronischen Angebots auf anderen Servern bedarf ebenfalls des schriftlichen Einverständnisses der Rechteinhaber.

Haftungsausschluss

Alle Angaben erfolgen ohne Gewähr für Vollständigkeit oder Richtigkeit. Es wird keine Haftung übernommen für Schäden durch die Verwendung von Informationen aus diesem Online-Angebot oder durch das Fehlen von Informationen. Dies gilt auch für Inhalte Dritter, die über dieses Angebot zugänglich sind.

Prefabrication of Main Elements for Long Bridges

Préfabrication d'éléments structuraux pour ponts de grande longueur

Vorfabrikation der Hauptelemente von langen Brücken

Carsten FRIES

Civil Engineer
COWIconsult
Virum, Denmark



Carsten Fries, born 1941, civil engineering degree from the Technical University of Denmark. During his professional career he has been involved in design, site supervision and maintenance of major bridges.

SUMMARY

The 80 m long steel girder sections of the two Faroe Bridges, altogether 3.3 km long, were prefabricated in a shipyard, and transported to the site at final bridge level. All sections were installed from the sea. The 6.6 km long West Bridge is prefabricated at a reclaimed harbour area. The main concrete elements – caissons, pier shafts, and girders – are cast in five production lines, moved and loaded out on piled trackways. A giant catamaran crane vessel takes over the further transportation and installation.

RESUME

Les éléments de tablier, en forme de caissons en acier de 80 m de long, ont été fabriqués sur un chantier naval pour l'ensemble des deux ponts de Faroe, soit une longueur totale de 3,3 km. Les caissons ont été remorqués sur le site de construction et mis en œuvre au niveau définitif du pont à partir de la mer. La préfabrication des 6,6 km du pont Ouest du Grand Belt a lieu sur une aire portuaire gagnée sur la mer. Les principaux éléments, à savoir caissons, piles et poutres, sont bétonnés sur cinq chaînes de fabrication, ripés latéralement sur des voies munies de rails, et repris par une grue, de type catamaran de 6000 tonnes de charge utile, pour leur transport et leur mise en œuvre.

ZUSAMMENFASSUNG

Die 80 m langen Abschnitte des Stahlüberbaus der beiden Faroe-Brücken, welche zusammen eine Länge von 3,3 km aufweisen, wurden auf einer Schiffswerft vorgefertigt und auf dem endgültigen Brückenniveau zur Baustelle transportiert. Alle Abschnitte wurden von der See aus montiert. Die 6,6 km lange Westbrücke wird in einem aufgespülten Hafengelände vorgefertigt. Die wesentlichen Betonelemente – Caissons, Pfeilerschäfte und Brückenträger – werden in fünf Festigungslinien hergestellt, auf pfahlgegründeten Verschiebebahnen vorgeschoben und von einem riesigen Katamaran-Schiffskran zum weiteren Transport und zur Montage übernommen.



1. INTRODUCTION

A main objective in the engineering design of long bridges across semi offshore waters is to minimize work at the bridge site. In Denmark, this has led to still more refined methods for prefabrication, moving, storing and loading of elements in harbour areas, and development of large capacity marine equipment for transportation and installation.

Two different bridge concepts are described in this paper:

The Farø Bridges, inaugurated in 1985. The steel box girder was fabricated in full span lengths by a shipyard and shipped to the bridge site. All erection work was performed from the sea.

The West Bridge under construction as part of the Great Belt Link. The overall concept for the concrete bridge is based on prefabrication of all main elements. Altogether 324 units comprising caissons, pier shafts, and girders will be cast in a reclaimed harbour area.

2. THE FARØ BRIDGES

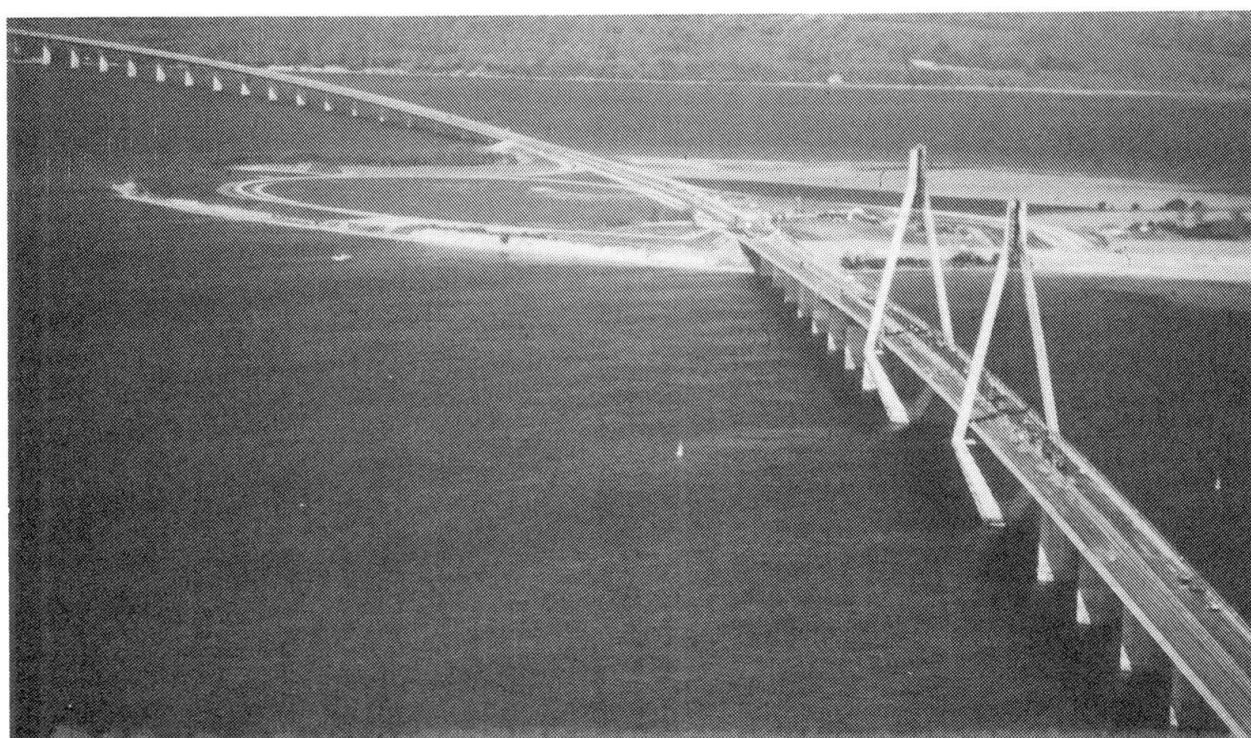

Fig. 2.1 The Farø Bridges.

The steel superstructure of the two Farø Bridges, altogether 3.3 km long, was for the main part built in 80 m sections. They were all transported to the site at final bridge level on a specially built catamaran vessel. The bridges carry a four track roadway with emergency lanes.

The use of steel for the superstructure first appeared as an alternative proposal at tendering for the job. The preliminary tender design was elaborated by COWIconsult and the contractor Monberg & Thorsen.

The optimum sea route from the shipyard to the bridge site was 52 nautical miles and involved passing an old bridge, which imposed a maximum height on the load. Therefore, five girders had to be sent by a 96 nautical miles different route.

2.1 The Sea Transport

Experience and other considerations concerning stability at sea, towing and steering, led to the choice of a catamaran vessel. The most difficult problem to solve was to construct the supporting steel members of the catamaran's superstructure to give sufficient protection to the box girder sections during towage and erection operations.

The thin plated box girder was relatively easily damaged outside the bridge bearings, which are the proper points of support. Consequently, the bottom of a box section was supported by 40 neoprene cushions while on the catamaran.

The cushions were distributed on two main frames, each supported by two hydraulic cylinders, which again rested on four supporting towers. The cylinders had a stroke of 1.5 m and were used primarily to aid the placing of the box sections on the bridge piers. During sea transport their function was to distribute the load. The four towers and the bracing in the four vertical main lattice girder planes could be altered in length according to the specific height of the different box sections and their position at the site.

The vessel was equipped with five electro-hydraulic mooring winches and a special hydraulic mooring device, which was of great importance for placing it in position between the bridge piers. Two electro-hydraulic rudder propellers were installed to easy operations both at the shipyard and at the bridge site.

For sea erection an operational wind speed of 16 m/s was assumed. The mooring gear and "tow boat power" was dimensioned for 20 m/s.

2.2 The Sea Erection

On arrival at the bridge site, the catamaran was moored at a proper distance from the bridge line to 7 t anchors, laid out and test-loaded beforehand.

The prismatic concrete bridge piers were fitted with heavy steel mooring frames, tightened and fastened by friction 2.5 m above sea level. A moveable arm with built-in rubber buffer was fitted to one end of the catamaran.

Under full control, the catamaran could be warped near the bridge site by its own winch and some hawser changes. The warping was controlled to position the catamaran's mooring arrangement close to a pier, chosen in advance. At the outer end, the mooring arrangement was equipped with an eye plate. The mooring arm was lowered over a vertical pin, fitted to the steel frame of the pier.

By use of a hawser winch the catamaran could now rotate freely in the erection span without any collision risk, and the girder section could be placed in the right position, vertically over the bearing points, on adjustment by the hydraulic cylinders of the mooring arrangement at one end and by a hawser winch at the other end of the vessel.

When the catamaran was positioned, the fastening at sea was released and the 600 t girder section was lowered by use of the four hydraulic jacks. Water ballast in the catamaran was used as means of adjustment.

The girder section was transferred to the fixed bearings on the piers with a tolerance of 30 mm in the horizontal plane. During this critical phase of the erection, the catamaran was securely fixed to two piers with visible mooring systems above water level.

Immediately before the lowering on the piers the alignment of the four bearing points on the pier tops was checked relative to the bottom of the box section. Where necessary, the alignment was adjusted in order to avoid inducing torsion in the bridge section by placing.

A girder section was placed in two minutes. The vertical and horizontal movements were very modest due to the size of the vessel relative to the wave lengths at the site. The vertical additional load due to the vertical acceleration of the vessel had been calculated to be very small, which was confirmed at the actual conditions.

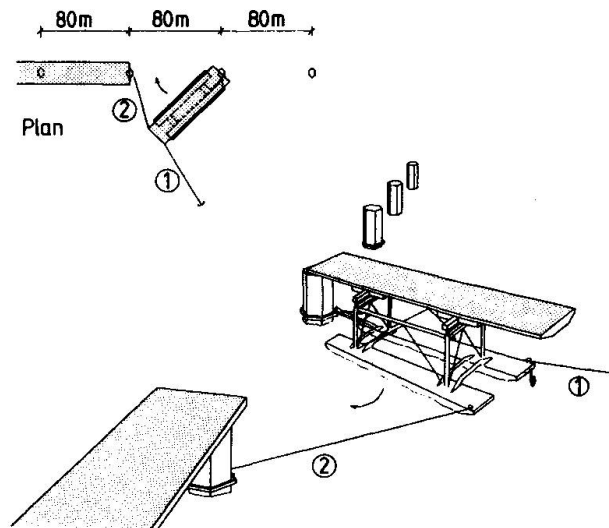

Fig. 2.2 Thus the catamaran was moved into position for final erection in the bridge line.



The bearings for the girders were adjustable in all directions in order to achieve the correct welding position. The weld between two 80 m sections was performed according to the same methods used at the shipyard.

2.3 Cable-Stayed Section

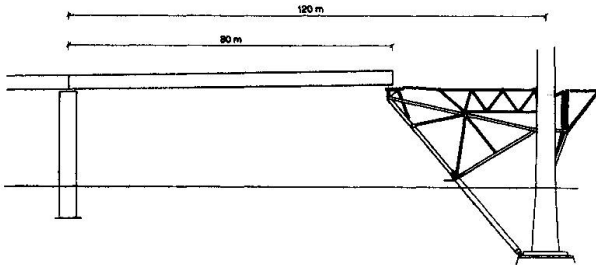

Fig. 2.3 A steel bracket was a support point for a 80 m section.

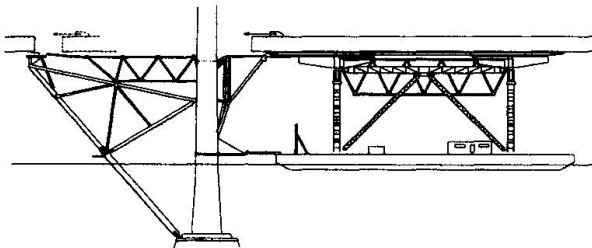

Fig. 2.4 The catamaran in position for hauling in a special tower section.

A cable-stayed section, spanning 290 m with two side spans of 120 m each presented a change in terms of erection. New provisional measures had to be introduced for the last four 80 m sections, two at each tower.

In the side span a steel bracket, projecting approx. 40 m from the tower, was built. It was supported by the pile-founded footing of the tower close to the sea bed 19 m below sea level, and fastened to the tower legs above sea level.

The steel bracket constituted a support point for the first of the four special designed 80 m bridge sections, which could be erected more or less according to the standard sea erection method, as one end was placed on the side span pier, and the other end on the bracket.

The following 80 m section - actually 78 m - would in its final position fill in the lacking 39 m in the side

span and project 39 m into the main span, being placed in between the two legs of the tower. After having compared various methods from economic and safety points of view, the Contractor decided also to transport this special section to the site at the final bridge height, and haul it in between the legs of the tower sliding on Teflon.

It was necessary to erect yet another auxiliary construction in the tower. Facing the navigation span, a vertical pendulum support was erected 4 m from the axis of the tower, dimensioned for dead load from the bridge roadway in the side span and 39 m of the main span, and effective until the cable stays could take over the bridge girder load.

The reminding part of the 290 m long navigation span was constructed in 16 m sections, transported to the site on a traditional barge, and hoisted into the final position by derricks.

3. THE WEST BRIDGE

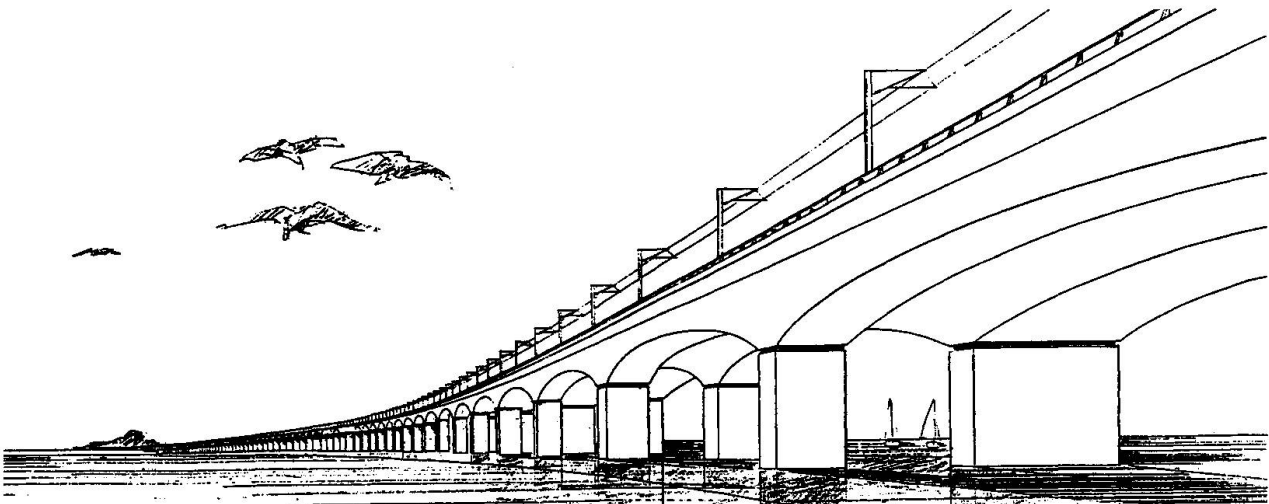

Fig. 3.1 Perspective view of the West Bridge.

The 6.6 km bridge consists of two haunched box girders each supported on separate pier shafts sharing a common substructure designed as a gravity founded caisson. The northern girder carries the rail track, and the southern the road traffic.

3.1 Superstructure

The superstructure is divided into 51 main spans of 110.40 m and 12 expansion joint spans of 81.75 m. Expansion joints are provided at the abutments and at five interior piers, thus subdividing the overall length into six continuous girders of about 1.100 m.

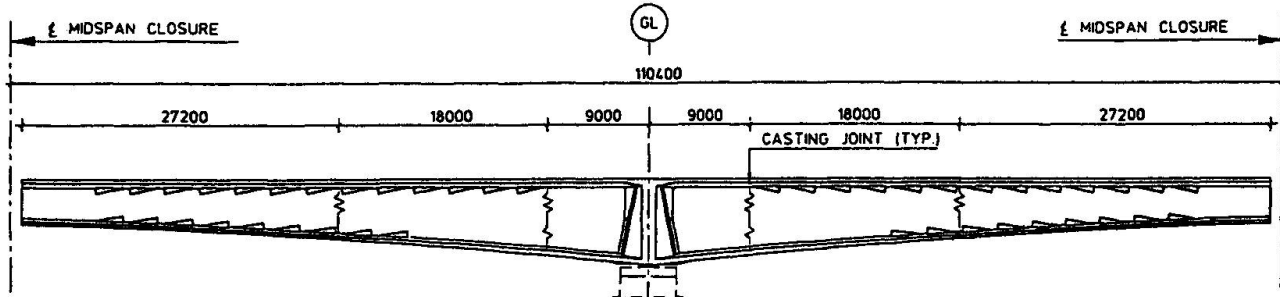

Fig. 3.2 Longitudinal section in bridge superstructure.

The box girder's two webs have a uniform thickness of 500 mm. The deck slab is prismatic with its thickness varying in the transverse direction from 250 mm to 600 mm in the cantilever portion, and from 300 mm to 600 mm between the webs. The bottom slab thickness varies between a minimum of 250 mm at midspan and a maximum of 700 mm at the pier.

The railway girder has an overall depth of 8.70 m and 5.13 m at midspan. The roadway girder depths are 7.34 m and 3.78 m, respectively. Due to the differences, the bottom level of the rail girder is 1.90 m below the road girder.

3.2 Foundation and Substructure

The soil conditions in the western channel facilitate direct foundation in glacial till, marl or limestone with reasonably good strength.

The substructure includes 2 abutments and 62 offshore piers with a foundation level between -11 m and -29 m.

With regard to design and construction there are no major differences between the shallow and deep water piers. The differences are of a dimensional nature only.

The girders are supported on rectangular pier shafts, both 5.00 m deep in the longitudinal direction of the bridge, and 12.25 m and 7.20 m wide. The centre to centre distance between the two girders is 20.05 m.

The pier shafts are supported by a reinforced concrete caisson consisting of a 6-8 m high base of 17.00 x 29.275 m and a shaft capped with a massive concrete plinth. The caisson is sand filled and designed as a gravity based structure to support the bridge and to resist ship impact and ice loads.

3.3 Construction

Altogether 324 pre-fab units, comprising 62 caissons, 124 pier shafts, and 116 standard and 24 special bridge girders, will be cast, moved and assembled to compose the West Bridge.

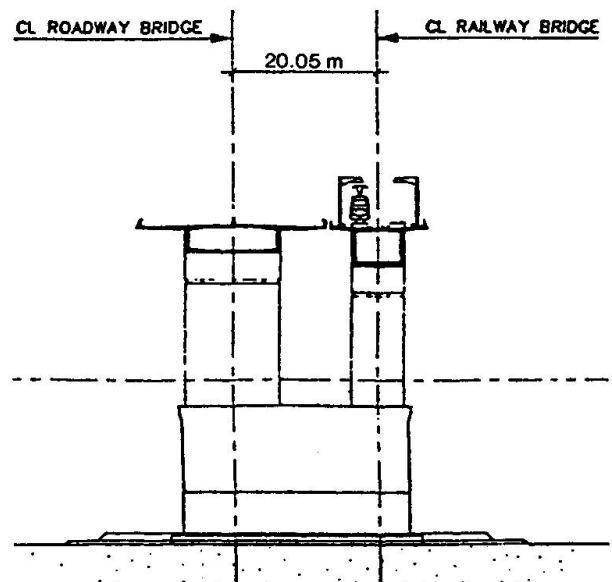

Fig. 3.3 Caisson, pier shaft, and superstructure.

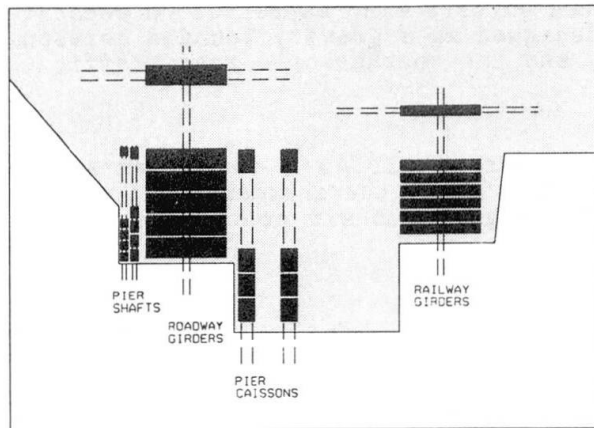

Fig. 3.4 Prefabrication yard.

The Swan is capable of lifting the various bridge elements off the loading out piers at the production yard, and transport them to the bridge site for installation.

The hoisting points are adjustable two by two in the transverse direction between two lockable positions. The distance between the centre line of the hoisting tackle and the aft-side of the structure connecting the two pontoons is 28.5 m.

The vessel is capable of self positioning on eight anchors, two of which are normally carried on board, while the others are pre-installed on the seabed.

The working conditions for the vessel have been determined to a max. wind speed of 15 m/s, max current of 1.5 m/s, and max. water depth of 5 m.

The up to 6.000 tons heavy caissons are placed on compacted, levelled stone beds of 1.5 to 5 m thickness, soft superficial layers first excavated. When the caissons are sand filled, the pier shafts are placed on top. The two elements are connected by an in-situ joint cast within dewatered cofferdams.

The girders weighing up to 5.700 tons are first placed on temporary bearings, e.g. jacks take over the weight and provide fixity for out-of-balance loads. After casting the in-situ mid span joint and applying prestressing, the girder is adjusted and the permanent bearings are connected by grouting.

The contract was let to the Contractor in June 1989 for the bridge to be completed in 1993 for the rail and in 1996 for the road part.

The elements - many weighing up to 6.000 tons and including some 2.400 m³ of concrete - are cast in five production lines, two for girders, two for caissons, and one for pier shafts. They are moved and loaded out on piled trackways with a top surface of greased steel. The load moving force is provided by jacks which means that heavy gantry cranes or drydocks for caissons are avoided.

The further transportation and installation of the bridge elements is performed by "the Swan", a large catamaran crane vessel with overall dimensions of 94 x 65 m and a hoisting capacity of 6.500 tons.

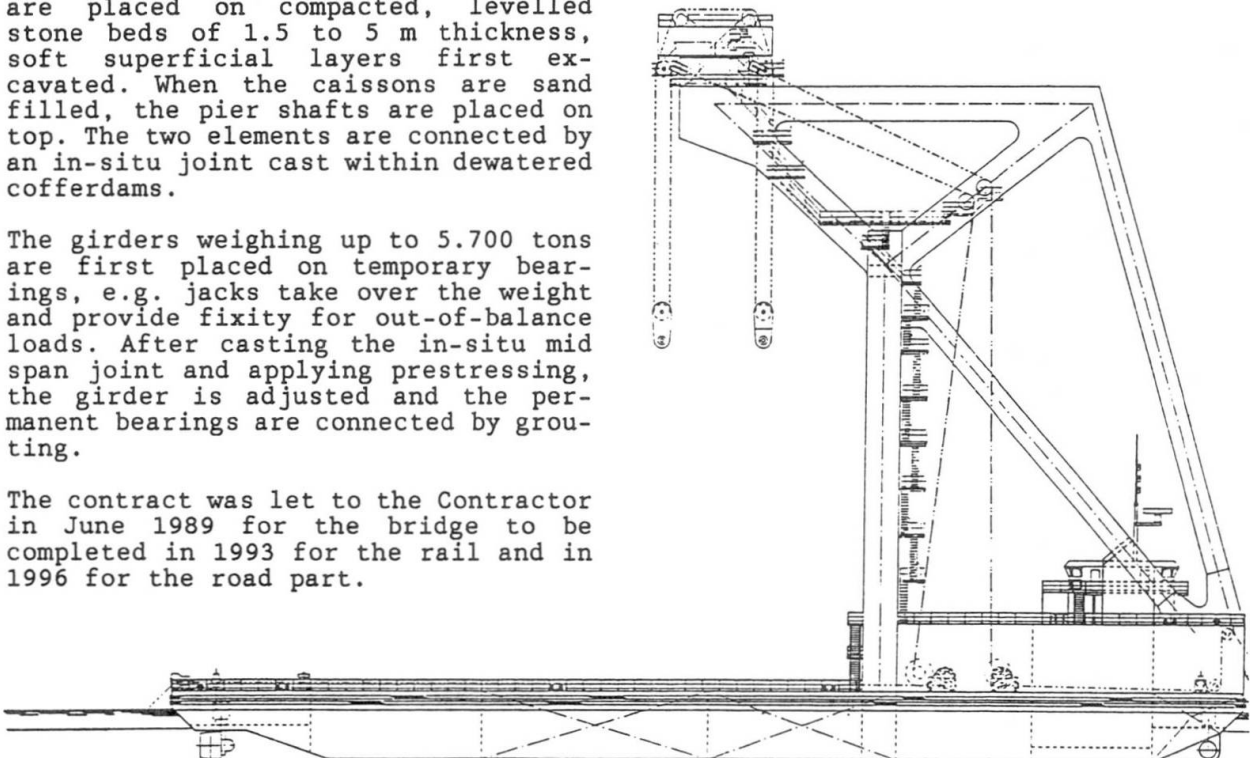

Fig. 3.5 The catamaran crane vessel.