

Design principles and construction methods of the Sunshine Skyway Bridge

Autor(en): **Muller, Jean / Tassin, Daniel**

Objektyp: **Article**

Zeitschrift: **IABSE reports = Rapports AIPC = IVBH Berichte**

Band (Jahr): **55 (1987)**

PDF erstellt am: **26.09.2024**

Persistenter Link: <https://doi.org/10.5169/seals-42706>

Nutzungsbedingungen

Die ETH-Bibliothek ist Anbieterin der digitalisierten Zeitschriften. Sie besitzt keine Urheberrechte an den Inhalten der Zeitschriften. Die Rechte liegen in der Regel bei den Herausgebern.

Die auf der Plattform e-periodica veröffentlichten Dokumente stehen für nicht-kommerzielle Zwecke in Lehre und Forschung sowie für die private Nutzung frei zur Verfügung. Einzelne Dateien oder Ausdrucke aus diesem Angebot können zusammen mit diesen Nutzungsbedingungen und den korrekten Herkunftsbezeichnungen weitergegeben werden.

Das Veröffentlichen von Bildern in Print- und Online-Publikationen ist nur mit vorheriger Genehmigung der Rechteinhaber erlaubt. Die systematische Speicherung von Teilen des elektronischen Angebots auf anderen Servern bedarf ebenfalls des schriftlichen Einverständnisses der Rechteinhaber.

Haftungsausschluss

Alle Angaben erfolgen ohne Gewähr für Vollständigkeit oder Richtigkeit. Es wird keine Haftung übernommen für Schäden durch die Verwendung von Informationen aus diesem Online-Angebot oder durch das Fehlen von Informationen. Dies gilt auch für Inhalte Dritter, die über dieses Angebot zugänglich sind.

Design Principles and Construction Methods of the Sunshine Skyway Bridge

Projet et construction du nouveau pont de Tampa, USA

Projekt und Ausführung der Sunshine Skyway Brücke in Tampa, USA



Jean MULLER
Technical Director
Figg and Muller Engineers, Inc.
Paris, France



Daniel TASSIN
Technical Director
Figg and Muller Engineers, Inc.
Paris, France

SUMMARY

The new Sunshine Skyway Bridge across Tampa Bay in Florida, USA, has a main span of 366 m above the navigation channel. The 30 m wide deck is a concrete single box girder supported by a single row of multiple stays. Precast segments with matching epoxy joints are assembled by external prestressing. The high level approach viaducts on either side of the main 1,200 m unit are also built with the same concept. The highway traffic is carried directly on the as-cast surface of the precast segment top slab with no waterproof membrane and overlay.

RÉSUMÉ

Le nouveau pont de Tampa, aux États-Unis, franchit le chenal de navigation avec une portée libre de 366 m. Le tablier comporte un caisson unique en béton précontraint porté par une nappe centrale de haubans multiples. Les voussoirs préfabriqués à joints conjugués avec résine époxyde sont assemblés par précontrainte extérieure. Les travées d'accès à la portée centrale sont construites selon la même technique.

ZUSAMMENFASSUNG

Die neue Sunshine Skyway Brücke über die Tampa Bucht hat eine Hauptspannweite von 366 m, die als Schifffahrtsöffnung dient. Der Ueberbau besteht aus einem 30 m breiten, einzelligen Kastenquerschnitt in Beton, der durch eine Vielzahl von Schrägseilen in der Mittelebene unterstützt ist. Vorfabrizierte Segmente mit Kunstharzfugen sind durch externe Spannkabel zusammengespannt. Die Seitenspannweiten sind ebenfalls mit der gleichen Technik gebaut. Die Strassenfahrzeuge fahren direkt auf der Betonoberfläche der Segmente ; es ist weder eine Isolation noch ein Belag vorhanden.



The new Sunshine Skyway Bridge is located south of Tampa, Florida, U.S.A., between St. Petersburg and Bradenton (see Fig. 1).

This structure now complete has a total length of 21,900 ft (6,680 m) and carries two twin 40 ft (12 m) roadways. With a total construction cost in excess of USD 200 M, this bridge project is one of the largest in the world today.

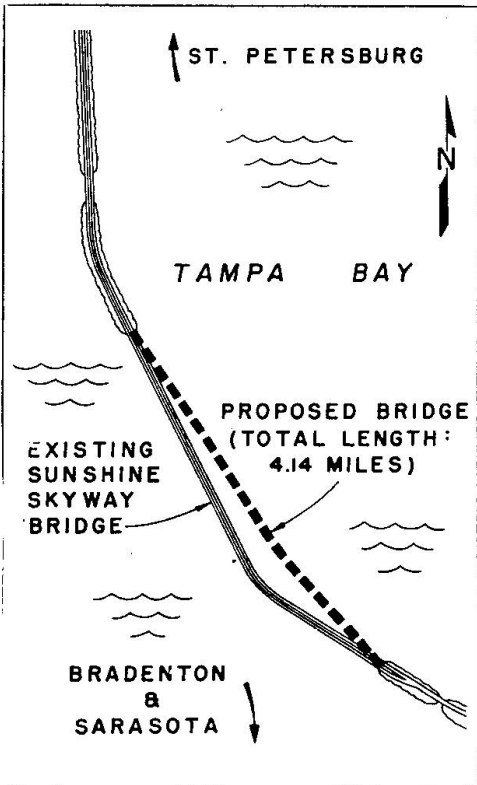

Fig. 1 Location Plan

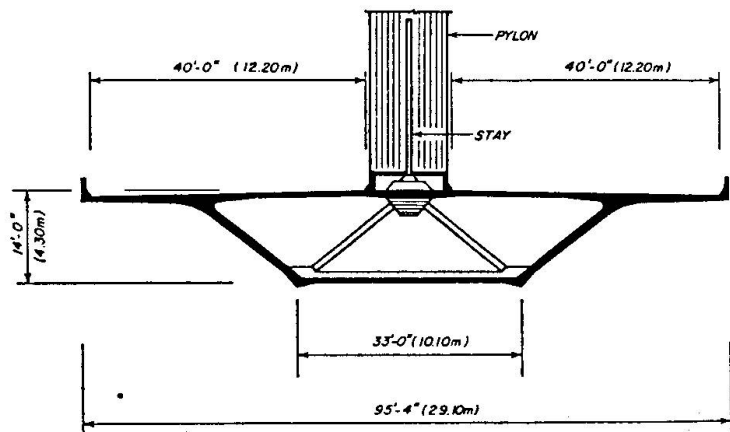

Fig. 2 Typical Section of Single Box Girder

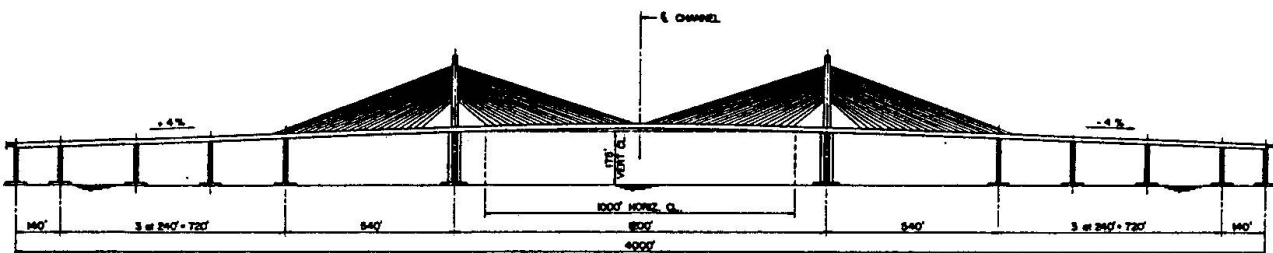

Fig. 3 Elevation of Center 4,000 ft Unit



The center portion of the bridge makes use of precast segmental construction on a total length of 8,860 ft (2,700 m):

- Two high level approaches with 135 ft (40 m) spans and twin separate box girders resting on precast segmental piers lead to the main structure,
- The main structure, 4,000 ft (1,200 m) long, has a single box girder 94 ft (28.70 m) wide resting on cast-in-place box piers (see Fig. 2 and 3).

The main span over the navigation channel has a clear opening of 1,200 ft (367 m) and is suspended to a single center system of cable stays and reinforced concrete pylons.

The structures are designed for AASHTO highway loads and hurricane conditions. The maximum design wind pressure at the pylon top was taken at 80 psf, which corresponds to a wind velocity (including gust factor) of 180 mph. Very elaborate aeroelastic studies were conducted with two tunnel test models to ascertain the dynamic stability of the bridge and to obtain reliable static coefficients used for the design (see Fig. 7).

The drag factor of the deck box girder with the barrier curb is 1.35, in relation to the surface area seen in elevation. A steady horizontal wind flow creates a significant uplift, while the slope of the web contributes to adding a torque moment also.

The main deck box girder is prestressed transversally and vertically to resist local bending due to traffic loads and all shear stresses.

Longitudinally, the precast segments are assembled by external prestressing tendons (see Fig. 6). Together with the axial load created by the component of stay loads, all joints at top and bottom fibers are maintained under permanent compression under the combined effects of all loads, temperature gradients and long term redistribution of internal stresses. Longitudinal tendons are laid above the bottom slab inside the box section and are successively draped to be anchored in the stay anchor blocks located in the median strip at roadway level. A full continuity between stays and tendons is thus achieved in the main span, much in the same manner as in a suspension bridge.

Stays are located in the plane of symmetry of the bridge at 24 ft intervals with a fan layout which represents the best compromise between magnitude of axial load in deck, economy in weight of stays and simplicity of construction. The angle between deck and stays varies between 22 and 47°, while each stay is made up of 60 to 80 strands 0.6" dia., 270 ksi ultimate strength with a maximum allowable stress of $0.45 \times 270 = 120$ ksi. All stays are encased in a steel pipe and cement grouted after stressing and final adjustment. Stage stressing includes a provision to place permanently the steel casing and the grout column under compression, to minimize the effect of live load and fatigue due, in particular, to local bending near the anchors.

Like in Brotonne Bridge built in France between 1974 and 1977 (which has performed extremely well now for ten years), the stays are continuous through the pylon where a double pipe is used as a deviation saddle, while allowing stay replacement in the future. A full scale laboratory fatigue test was performed to verify the adequacy of this important feature of the design. It was found, in three successive tests, that no wire breakage occurred in the saddle and that the grout was in perfect condition after pulsation of 2,000,000 cycles.

The deck box section is rigid from the twofold view-point of longitudinal bending and torsion, which reduces the deflections and rotations under live loads. For example, if half of the bridge is assumed to carry three lanes of traffic on the full length of the main span, while the other half is left completely unloaded, the transverse rotation at mid-span is only 0.4%.

Second-order stresses are, consequently, also very small, with a large safety margin against deck buckling. The equivalent slenderness ratio of the deck, in the analogy of a beam on elastic foundation, is only 60.

Another consequence of the deck rigidity is that the accidental loss of a stay has little effect on the behaviour of the structure.

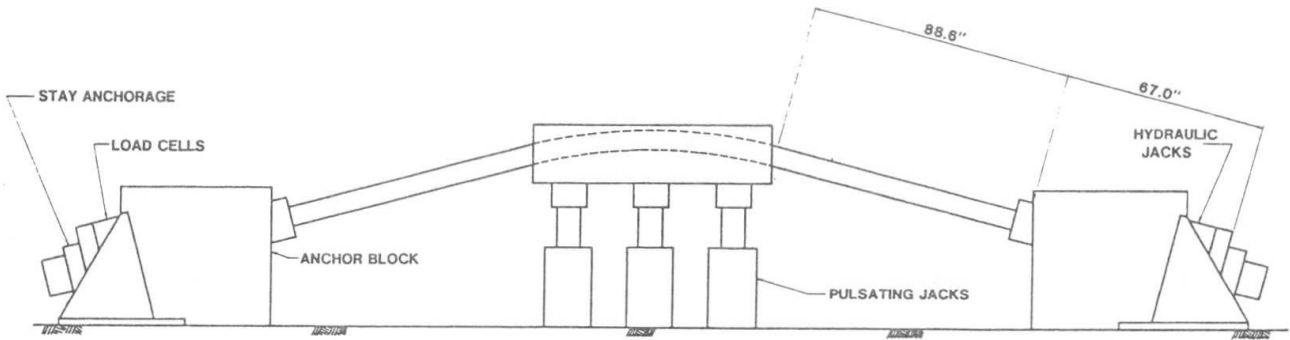

Fig. 4 Flexural Fatigue Test Setup for Stays

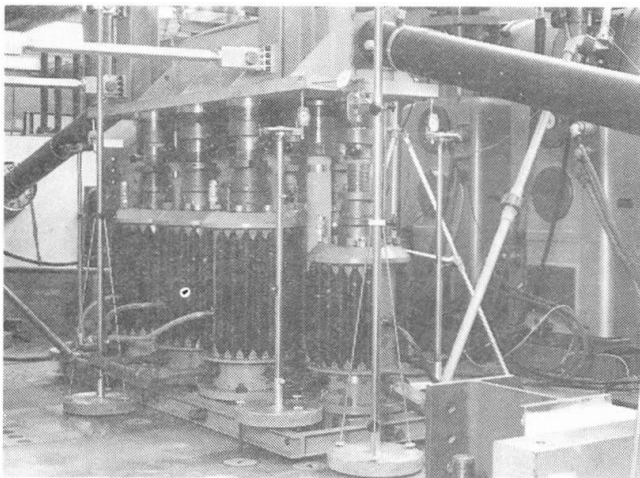

Fig. 5 View of Flexural Test in Laboratory

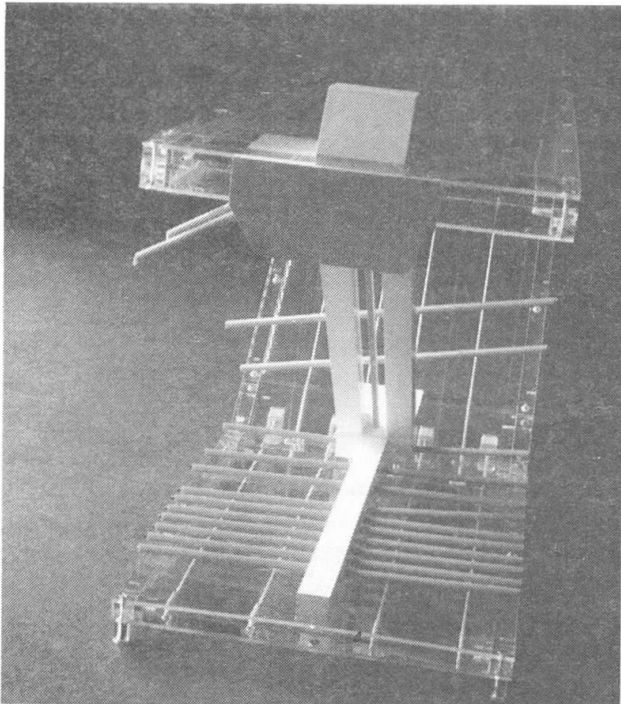

Fig. 6 Model Showing External Prestress

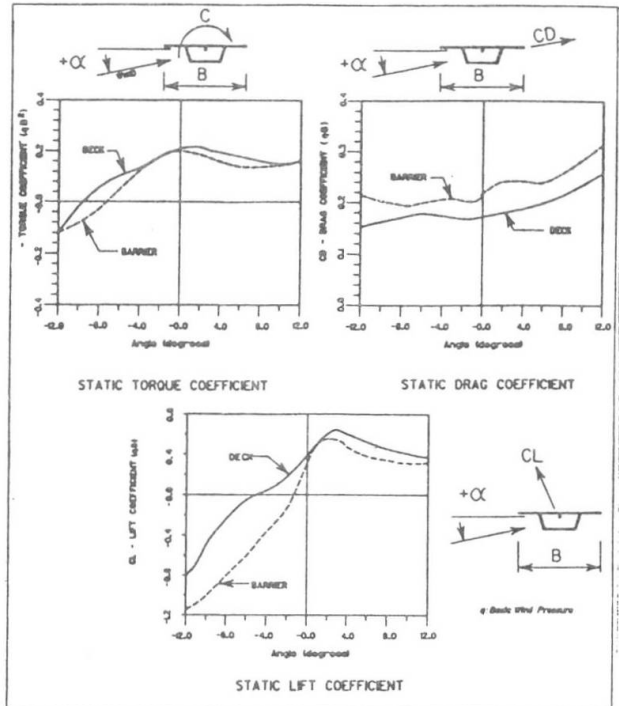

Fig. 7 Summary of Wind Section Model Test

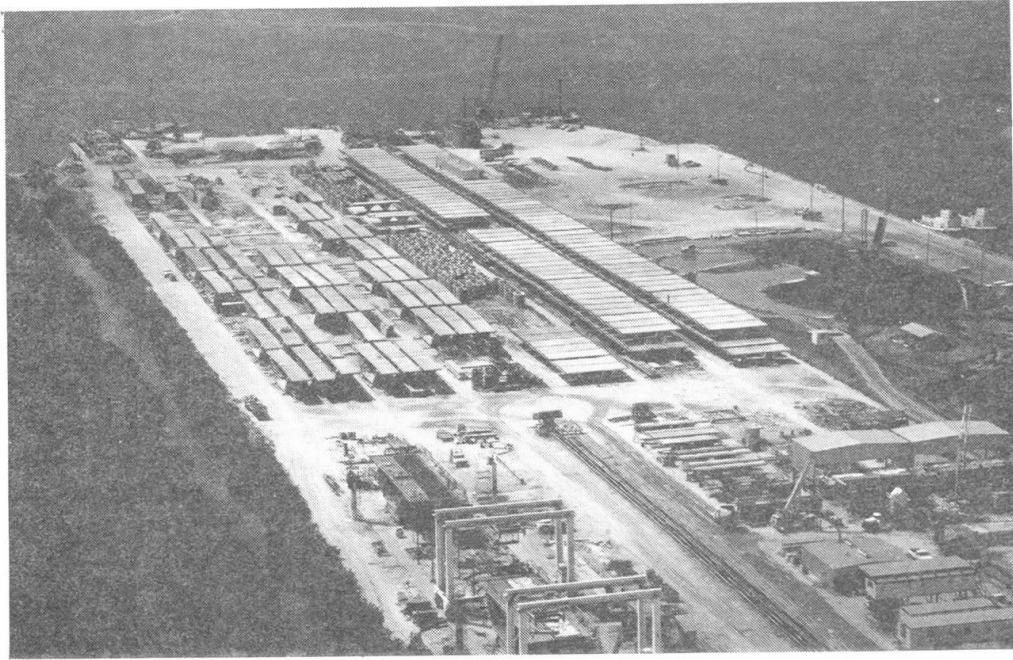

Fig. 8 Aerial View of Precasting Yard in Port Manatee

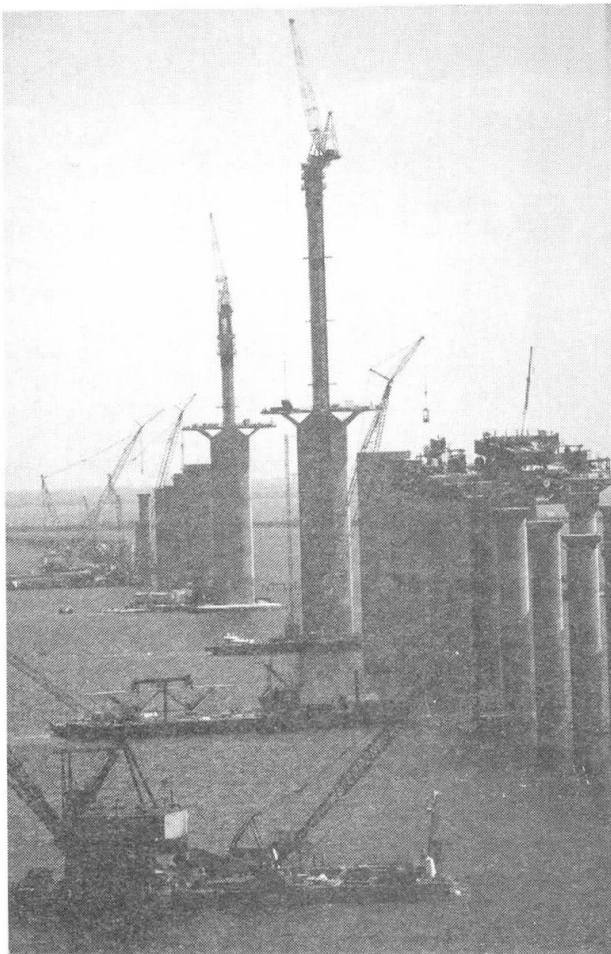

Fig. 9 Overall View of Construction Site

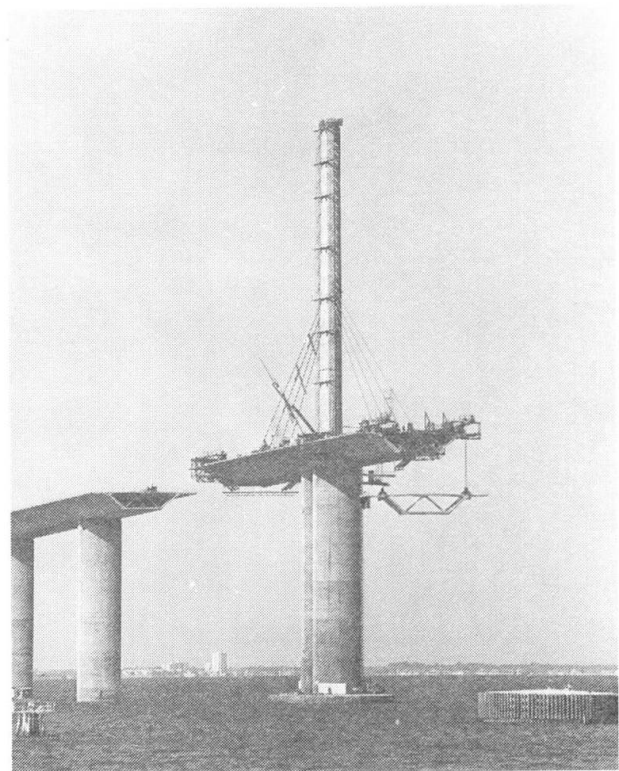

Fig. 10 Placing Precast Segments and Stays in Main Span



Fig. 11 Placing Last Segment in Main Span



Fig. 12 Aerial View of Main Span

Construction Methods:

All segments in the 4,000 ft center portion of the project are fully precast with a weight varying between 150 and 220 tons, and placed in the structure in balanced cantilever.

Precasting was handled in a large yard located in Port Manatee, south of Tampa Bay, the segments then being barged to the construction project. The 584 small segments for the approach viaducts and the 333 large segments for the center section were precast between March 1984 and April 1986.

Most of the large segments were erected in the bridge in less than one year, the last segment allowing closure of the main span being placed on August 23, 1986.

The bridge was opened to traffic in April 1987.