

Mathematical models of form and energy use

Autor(en): **Hawkes, Dean**

Objektyp: **Article**

Zeitschrift: **IABSE reports of the working commissions = Rapports des commissions de travail AIPC = IVBH Berichte der Arbeitskommissionen**

Band (Jahr): **36 (1981)**

PDF erstellt am: **24.09.2024**

Persistenter Link: <https://doi.org/10.5169/seals-28271>

Nutzungsbedingungen

Die ETH-Bibliothek ist Anbieterin der digitalisierten Zeitschriften. Sie besitzt keine Urheberrechte an den Inhalten der Zeitschriften. Die Rechte liegen in der Regel bei den Herausgebern.

Die auf der Plattform e-periodica veröffentlichten Dokumente stehen für nicht-kommerzielle Zwecke in Lehre und Forschung sowie für die private Nutzung frei zur Verfügung. Einzelne Dateien oder Ausdrucke aus diesem Angebot können zusammen mit diesen Nutzungsbedingungen und den korrekten Herkunftsbezeichnungen weitergegeben werden.

Das Veröffentlichen von Bildern in Print- und Online-Publikationen ist nur mit vorheriger Genehmigung der Rechteinhaber erlaubt. Die systematische Speicherung von Teilen des elektronischen Angebots auf anderen Servern bedarf ebenfalls des schriftlichen Einverständnisses der Rechteinhaber.

Haftungsausschluss

Alle Angaben erfolgen ohne Gewähr für Vollständigkeit oder Richtigkeit. Es wird keine Haftung übernommen für Schäden durch die Verwendung von Informationen aus diesem Online-Angebot oder durch das Fehlen von Informationen. Dies gilt auch für Inhalte Dritter, die über dieses Angebot zugänglich sind.



Mathematical models of form and energy use

Modèles mathématiques pour la forme d'une structure et l'utilisation de l'énergie

Mathematische Modelle für die Formgebung und Energienutzung

DEAN HAWKES

Director

Martin Centre for Architectural and Urban Studies

Cambridge, UK

SUMMARY

This paper argues that generalised conceptions of form are of fundamental importance in architectural design. The effective design of energy-conserving buildings requires a clear understanding of the relationship between form and energy use. The paper presents a survey of approaches to representing this relationship mathematically and discusses the influence which mathematical models have had upon the development of approaches to energy-conserving building design.

RESUME

L'article insiste sur l'importance essentielle du choix de la forme d'une structure dans le projet architectural. La conception efficace d'un bâtiment consommant peu d'énergie requiert une parfaite compréhension de la relation entre la forme et l'utilisation de l'énergie. Différents modèles mathématiques sont passés en revue; il est fait mention de leurs influences sur le projet de bâtiments fiables consommateurs d'énergie.

ZUSAMMENFASSUNG

Der Beitrag soll klar machen, dass verallgemeinerte Formgebungskonzepte für den architektonischen Entwurf von fundamentaler Bedeutung sind. Die zweckmässige Planung und Projektierung energiesparender Gebäude setzt ein klares Verständnis der Beziehung Form – Energieverbrauch voraus. Der Artikel gibt einen Ueberblick über verschiedene mathematische Methoden zur Erfassung dieses Zusammenwirkens und diskutiert den Einfluss, den mathematische Modelle auf die Entwicklung energiesparender Projekte von Gebäuden gehabt haben.



INTRODUCTION

The dictionary [1] defines form as, among other things, shape, outline, general appearance, type, order, arrangement, structure and established custom. Architects use the word in each and all of these meanings, sometimes with precision, as in the cases of order, arrangement or structure, and sometimes in an imprecise, but often potent, sense as with outline and general appearance. My dictionary's reference to established custom is particularly apt in architectural usage since there is evidence that much design derives from commonly held notions of what a building should be - a type or, more precisely, a stereotype [2]. These exist as generalised solutions to 'standard' problems and are used by many designers to inform the development of their specific designs. Inevitably they are subject to a process of re-evaluation, adaptation and change, but this only serves to confirm their utility not to challenge it. Form is therefore vitally important to an architect. In this paper the emphasis will be upon the references to shape and type, with the latter's connotation of established custom, in order to discuss the rôle and influence of mathematical modelling in the study of energy use in buildings.

MODELLING ENERGY USE

It is less than ten years since energy conservation became a major concern in building design. The first question which this raised in the minds of architects was, not surprisingly, "what shape is an energy conserving building?" In these few years a good deal of progress has been made towards finding an answer, or rather answers since there is no single, simple answer. Much of this work has made use of mathematical modelling techniques. In fact without some kind of quantitative analysis of a proposal it would be difficult for it to have much credibility. Perhaps this is the first time in the history of architecture that mathematics have been central to a major development.

Buildings use energy primarily in the process of environmental control - in providing a comfortable internal environment no matter what external conditions may exist. The problem of energy-conserving design thus becomes one of reducing the amount of energy used in heating, cooling, ventilating and lighting. All have some representation of the external climate, some definition of the internal conditions to be achieved and a means of describing the building itself.

Numerous large-scale computer models now exist which, in one way or another, meet this specification. One of the very first - predating the energy crisis - was developed at Cambridge in the late 1960's [3]. Many subsequent models have incorporated improved representations of the physics of energy flow, but it serves to give a picture of the general characteristics of models of this type.

The external climate was described in the following terms:

Table 1. Description of the external environment.

A. Thermal

1. External air temperatures at hourly intervals for cloudy and clear days, winter and summer.
2. Solar azimuth, hourly intervals, winter and summer solstices.
3. Solar altitude, hourly intervals, winter and summer solstices.
4. Direct and scattered solar radiation values.

B. Natural illumination

Whole sky illumination, hourly intervals, winter and summer solstices.

C. Noise

External noise levels.

In this model the internal temperature of the building was found using the 'Admittance Method' [4] which calculates the dynamic response of a building to inputs of energy as a series of deviations from a daily mean condition.

$$\left(\frac{Qf}{A}\right) = \frac{Q'f}{A} + \left(\frac{\tilde{Q}f}{A}\right) \quad (1)$$

Where $\frac{Q'f}{A} = U(t'_{eo} - t'_{ei}) \quad (1a)$

$$\left(\frac{\tilde{Q}f}{A}\right) = U(t_{eo} - t'_{eo}) \quad (1b)$$

Where $\left(\frac{Qf}{A}\right) = \text{heat flow into space at time } \theta + \phi \quad (W) \quad (W)$

$$\frac{Q'f}{A} = \text{mean heat flow into space} \quad (W)$$

$$\left(\frac{\tilde{Q}f}{A}\right) = \text{deviation from the mean heat flow at time } \theta + \phi \quad (W)$$

$$\phi = \text{time lag} \quad (\text{hours})$$

$$t'_{eo} = \text{daily mean sol-air temperature} \quad (^\circ\text{C})$$

$$t'_{ei} = \text{inside air temperature} \quad (^\circ\text{C})$$

$$f = \text{decrement factor}$$

The values of ϕ and f are derived from the thermal properties of the building fabric. Further terms are added to the basic equation to calculate the effect of direct solar gain through windows and the effects of ventilation. In addition the effects of the heat gain due to the occupants of the building and to the use of artificial lighting are included. The latter is, where appropriate, "switched" on or off by making reference to the amount of available daylight.

Conventionally, daylight levels in a building are expressed in terms of the Daylight Factor. This is defined as, "The ratio of the illumination inside the building to that outside." [5]. It is assumed that the sky is overcast and has a luminance distribution where:

$$B_{\theta} = B_z = \frac{1 + 2 \sin \theta}{3} \quad (2)$$

Where $B_{\theta} = \text{luminance at altitude } \theta$

$$B_z = \text{luminance at zenith}$$

The calculation of daylight factor assumes three components:

Sky component (SC)

Externally reflected component (ERC)

Internally reflected component (IRC)

The sky component for the sky luminance defined above is given by Hopkinson [6] as:



$$SC = \frac{3}{7\pi} \int_{\theta_{N_1}}^{\theta} \int_{\phi_2}^{\phi} \frac{\tan \theta_N \cdot \sec^2 \theta_N \cdot \sec^2 \phi}{(\sec^2 \theta_N + \tan^2 \phi)} + \frac{2 \tan^2 \theta_N \cdot \sec^2 \theta_N \cdot \sec^2 \phi}{(\sec^2 \theta_N + \tan^2 \theta_N^{5/2})} d\theta_N d\phi \quad (3)$$

Where θ = the angle of elevation of the visible patch of sky.
 ϕ = its azimuthal angle.

The externally reflected component is usually taken to be a proportion of the sky component obstructed and the internally reflected component is found by an equation based upon the split-flux principle [7]

$$IRC = \frac{0.85W}{A(1-R)} (CR_{fW} + 5R_{cW})\% \quad (4)$$

Where W = glazed area of window. (m²)
 A = total surface area of room. (m²)
 R = average reflectance of all surfaces.
 C = a function of the sky luminance distribution and the obstruction angle.
 R_{fW} = average reflectance of the floor and parts of the walls below the mid-height of the window, excluding the window wall.
 R_{cW} = average reflectance of the ceiling and parts of the walls above the mid-height of the window, excluding the window wall.

When the daylight factor has been calculated for a room it can be converted to a series of estimates of absolute illumination by multiplying it by hourly values of whole sky illumination. It is then possible to estimate whether artificial lighting would be in use.

A model of this kind, operating within a comprehensive description of a building's form, construction and details, can be used to carry-out very detailed analyses of energy flows. The effects of overall shape and overshadowing by neighbouring buildings can be evaluated, as can the consequences of changing such details as the size, shape and position of windows and of shading devices.

A great deal of work has been done to explore ranges of possibilities and to attempt to establish ground rules for design. To give an example the Cambridge model was used to study four simple alternative arrangements of a fixed amount of floor space (Figure 1).

These studies [8], which went into considerable detail produced the following data on the relationship between form and energy use.

Table 2 Comparison of peak and 24-hour cooling loads for fully glazed facades - Btu/h

No of storeys	Peak load	24-hour load
2	1,084,000 (317)	14,200,000 (4160)
4	1,501,000 (439)	18,900,000 (5537)
5	1,721,000 (504)	21,400,000 (6270)
10	2,792,000 (818)	33,700,000 (9874)
*10	2,227,000 (652)	26,700,000 (7823)

* This case has long axis east-west
 Figures in parenthesis are in kilowatts

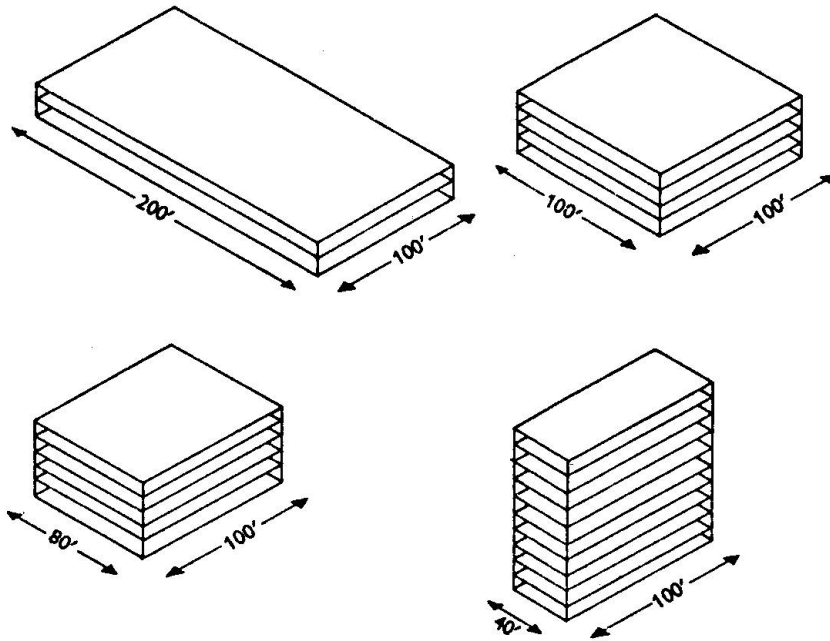

Figure 1

The clear lesson of this study is that energy consumption for summer cooling is much lower in a low, compact form than in a high-rise alternative, even allowing for the fact that the low building would use an amount of energy in artificial lighting, whereas the tall form would allow for full natural lighting in summertime. These results, and those from other, similar studies led to the deep-plan building being enthusiastically taken-up as an answer to the question of the shape of the energy-conserving building and, thus, to its rapid establishment as a design stereotype for many kinds of building.

Following this a number of mathematical models were developed which specifically aimed to aid the design of buildings of this type. These took many forms, some simple and some complex. Two contrasted examples will be described. The first is a simple model in which the simultaneous heat losses and gains in a building are related through the concept of the thermal balance point, that is the temperature at which gains equal losses. The basis of the analysis is the simple, steady-state heat loss equation:

$$Q_f = UA(t_i - t_o) \quad (5)$$

Where:

Q_f	= rate of heat transfer	(w)
U	= thermal transmittance of material	(w/m ² °C)
A	= area of element	(m ²)
t_i	= temperature inside building	(°C)
t_o	= temperature outside building	(°C)

In any building there will be heat gains from 'internal' sources such as people, artificial lighting and machinery. In addition there will be some contribution from solar gain. In the case of a deep-plan building it is reasonable to



assume a high heat input from artificial lighting and that the solar gains will constitute only a relatively small proportion of the total heat gain, and that more of it will occur in summer than in winter. On these assumptions it is possible to plot a graph in which these gains are related to outdoor temperature (Figure 2).

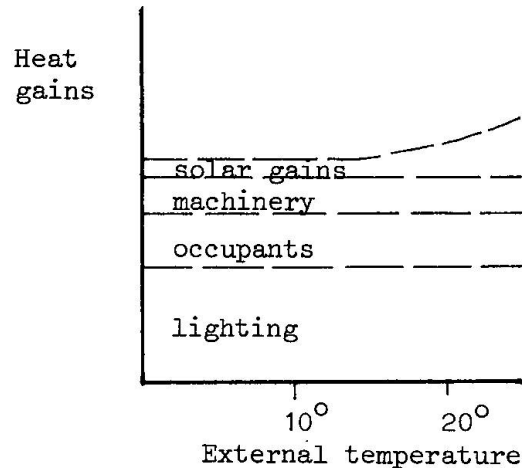

Figure 2

Using the steady-state equation it is then possible to calculate the heat loss from the building as a function of the internal-external temperature difference and to superimpose this upon the graph (Figure 3).

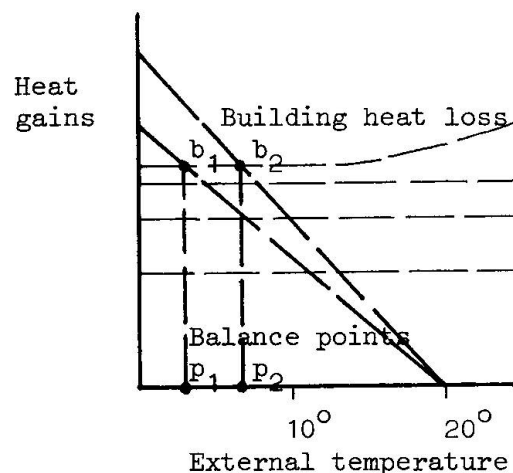

Figure 3

The slope of this curve is a function of the thermal efficiency of the building envelope. The greater its efficiency, expressed in heat loss per unit temperature difference, the lower the balance point. If this is pushed down to a low level, say 0°C , it is apparent that the building will not be likely to need any direct space heating in a temperate climate like that of Britain. This brings savings in the capital cost of plant in an air-conditioned building. Cooling will be required for a good proportion of the year whenever the outdoor temperature is significantly above the balance point. In its application this model confirms the advantages of the compact, deep-plan form in energy conservation, when compared with a form, such as a tower which arranges the same floor area within an envelope of greater area. In both cases it is assumed that the building will have a cooling plant.

The properties of the compact form have been investigated in great detail by Jones [9] using a complex model in which the climatic energy flow through the building envelope is broken-down into six elemental flux values representing the four walls, the roof and natural infiltration of air.

$$C = F_1 + F_2 + F_3 + F_4 + F_5 + F_6 \quad (6)$$

For a wall of a given orientation

$$F_1 = znX_1Q_1 \quad (7)$$

Where: $Q_1 = T_{w1}(1 - A_{g1}) + T_{g1}A_{g1} + S_{g1}A_{g1} \quad (8)$

z = floor-to-floor height (m)

n = number of storeys

X = length of facade (m)

T_{w1} = mean specific energy flow rate in any hour through wall 1 (w/m²)

T_{g1} = mean specific energy flow rate during the occupied or unoccupied period arising from air-to-air transmission and long-wave radiation exchange through the window glass of wall 1 (w/m²)

A_{g1} = glazed fraction of wall 1

S_{g1} = mean specific air-conditioning load (heat gain) in any hour arising from direct and diffuse solar radiation through the window glass of wall 1 (w/m²)

Similar equations are used to evaluate the flux flowing through the roof and that due to infiltration. All of the equations are solved for each hour of a typical day for each month of the year. The basic physics is similar to that of the Cambridge model outlined above, with a number of refinements, specifically to deal with the effect upon available solar radiation of cloud cover and the use of a statistical model of outdoor temperature. The energy flows through the individual elements are summed over the whole year and thus, an estimate is made of the total annual energy demand of the building.

Using this model Jones has examined in detail the relationship between built form, construction and energy use in air-conditioned buildings. His results confirm the general conclusions of earlier work, but in some respects offer a new degree of refinement. On the question of building shape he concludes that the best forms are those with the minimum ratio of surface area to floor area. Circular or square buildings are suggested as 'theoretically' preferable, and large buildings rather than small. The amount of glazing in the walls is shown to have a major influence upon energy use and the effect of glazing areas upon form is clearly illustrated in the comparison between the forms at Figure 4.

The models described all serve to develop an understanding of the relationship between form and energy use in buildings which use their external envelope to reduce the impact of the external climate upon the internal environment. In most cases these buildings make use of air-conditioning and some permanent artificial lighting. It is, however, possible to approach the question of energy-conserving design from a different standpoint in which the external environment is 'filtered' rather than excluded by the building envelope in an attempt to select those elements which are beneficial and to exclude those which are undesirable [10]. Such buildings are inherently different to those



discussed so far and it is necessary to adopt a different approach to modelling their energy performance.

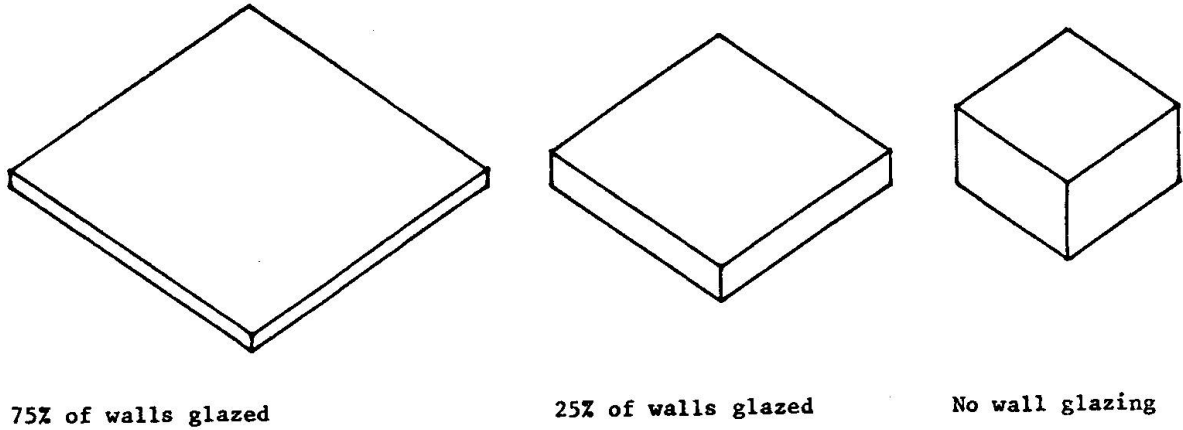

Figure 4

In each case the gross floor area is 25400m^2 . The consequences of increasing the glazed area is to modify the form to reduce the overall wall area.

One of the most appropriate approaches to modelling buildings in which direct solar radiation is accepted as a primary, desirable input into the energy system is the thermal network. Davies [11] has presented a clear outline of the basic theory in which the separate effects of enclosure geometry and surface emissivity are distinguished. A simple representation of a cubic room takes the form shown at Figure 5.

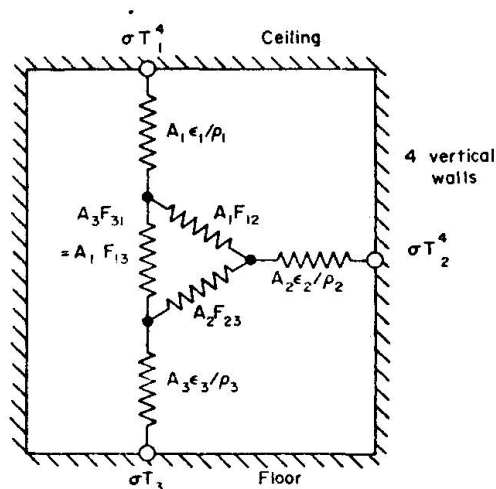
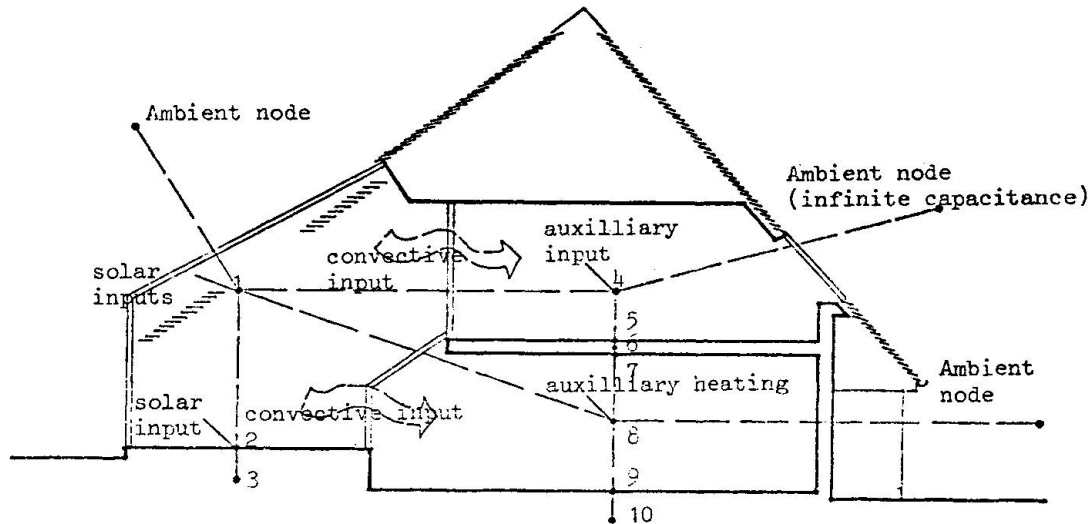

Figure 5 Thermal circuit illustrating radiant exchanges between a ceiling at T_1 with walls at a uniform temperature T_2 and the floor at T_3

A similar approach has been adopted by Baker [12] in work at Cambridge in studying the energy performance of school designs in which passive solar gain is exploited. In this model a network of capacitances and conductances is explicitly derived from the building configuration (Figure 6)



Electrical analogue

Capacitances $C_1 - 10$

Conductances ϵ_{12} etc

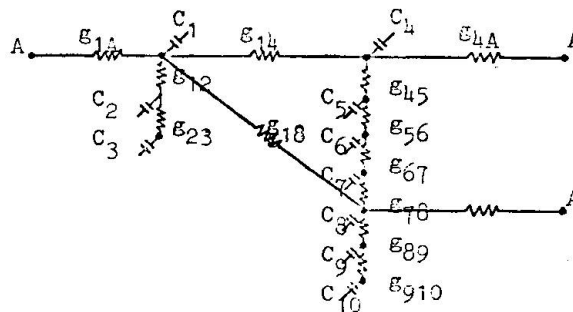

This is thence translated into a set of equations and evaluated for any given values derived from the constructional details of the building. In the particular case illustrated [13] the form and properties of the building clearly contradict the conclusions suggested by the models described above. The analysis has shown, however, that a design of this type achieves an energy performance which is more than comparable with that offered by a compact, minimally glazed form of similar floor area.

CONCLUSION

This paper has briefly reviewed the development of mathematical models for the study of the relationship between built form and energy use. By the use of models of many kinds a body of information is quickly accumulating through which this complex relationship may be understood by designers. On the evidence of much of the work it appears that the full complexity of the problem is best explored by the development of models which aim to address specific issues. As the examples illustrated above indicate, there is no unique answer to the question of the shape of an energy-conserving building. It depends



crucially upon the assumptions which are made about the building and its environmental systems at the very outset. The problem of an air-conditioned building is quite different to that of a passive solar building, and this difference should also be reflected in the models which are used to study them. It is gratifying to note that, in this field, architectural science has managed to avoid the trap of determinism which has, arguably, compromised its acceptance in the past. We have a spirit of inventive inquiry in which mathematical models are playing a central rôle.

REFERENCES

1. The Penguin English Dictionary. Penguin Books, 1969.
2. Hawkes, D. 'Types, norms and habit in environmental design', in March, L. (ed) The architecture of form. Cambridge University Press, 1976.
3. Hawkes, D. 'Modelling the environmental performance of buildings', in March, L. (ed) The architecture of form. Cambridge University Press, 1976.
4. Loudon, A.G. 'Summertime temperatures in buildings. BRS Current Paper 46/48 Building Research Station, 1968.
5. Hopkinson, R.G. Architectural physics: lighting. HMSO, 1964, p.26.
6. *ibid*, p.86
7. *ibid*, p.86
8. Hawkes, D. *op cit*
9. Jones, W.P. 'Built form and energy needs' in Sherratt, A.F.C. (ed) Energy conservation and energy management in buildings. Applied Science, 1976.
10. This distinction is discussed at length in, Hawkes, D. 'Building shape and energy use' in Hawkes, D. (ed) The architecture of energy. Construction Press/Longmans, 1981.
11. Davies, M.G. 'A thermal circuit for radiant exchange', Building and Environment, Vol. 14, pp. 43-46, 1979.
12. Baker, N. V. 'A selective approach to energy conservation in buildings'. A Science Research Council funded project at the Martin Centre, University of Cambridge. 1980-81.
13. This is a design for a junior school at Locksheath, Hampshire by the County Architect's Department in collaboration with the Martin Centre.