

Zeitschrift: IABSE surveys = Revue AIPC = IVBH Berichte
Band: 1 (1977)
Heft: S-1: Prestressed concrete flat slabs

Artikel: Prestressed concrete flat slabs
Autor: Marti, P. / Ritz, P. / Thürlimann, B.
DOI: <https://doi.org/10.5169/seals-43578>

Nutzungsbedingungen

Die ETH-Bibliothek ist die Anbieterin der digitalisierten Zeitschriften auf E-Periodica. Sie besitzt keine Urheberrechte an den Zeitschriften und ist nicht verantwortlich für deren Inhalte. Die Rechte liegen in der Regel bei den Herausgebern beziehungsweise den externen Rechteinhabern. Das Veröffentlichen von Bildern in Print- und Online-Publikationen sowie auf Social Media-Kanälen oder Webseiten ist nur mit vorheriger Genehmigung der Rechteinhaber erlaubt. [Mehr erfahren](#)

Conditions d'utilisation

L'ETH Library est le fournisseur des revues numérisées. Elle ne détient aucun droit d'auteur sur les revues et n'est pas responsable de leur contenu. En règle générale, les droits sont détenus par les éditeurs ou les détenteurs de droits externes. La reproduction d'images dans des publications imprimées ou en ligne ainsi que sur des canaux de médias sociaux ou des sites web n'est autorisée qu'avec l'accord préalable des détenteurs des droits. [En savoir plus](#)

Terms of use

The ETH Library is the provider of the digitised journals. It does not own any copyrights to the journals and is not responsible for their content. The rights usually lie with the publishers or the external rights holders. Publishing images in print and online publications, as well as on social media channels or websites, is only permitted with the prior consent of the rights holders. [Find out more](#)

Download PDF: 24.04.2026

ETH-Bibliothek Zürich, E-Periodica, <https://www.e-periodica.ch>

Prestressed Concrete Flat Slabs

Dalles plates précontraintes

Vorgespannte Flachdecke

MARTI P.
dipl. Ing.

RITZ P.
dipl. Ing.

THÜRLIMANN B.
Prof. Dr.

Institute of Structural Engineering,
Swiss Federal Institute of Technology (ETH), Zürich

SUMMARY

A short review on the analysis and the design of prestressed flat slabs is given. Some new aspects concerning flexural behavior, punching, reinforcement arrangement and detailing are presented. Different possible tendon layouts are compared. A new model for slabs with unbonded tendons and additional reinforcement is described.

RÉSUMÉ

L'article rappelle les différentes méthodes de calcul des dalles plates, précontraintes, sans champignon. Les auteurs présentent certains aspects nouveaux concernant la flexion, le poinçonnement, les différentes possibilités de répartition des câbles, l'armature conventionnelle et les problèmes constructifs. Ils présentent en outre un modèle qui explique le comportement à la flexion des dalles précontraintes avec des câbles non injectés et avec une armature conventionnelle.

ZUSAMMENFASSUNG

Neben einem kurzen Überblick über die übliche Berechnungs- und Bemessungspraxis von vorgespannten Flachdecken werden einige neue Gesichtspunkte hinsichtlich Biegeverhalten, Durchstanzen, Bewehrungsanordnung und besonderer Ausführungsprobleme dargelegt. Verschiedene Kabelanordnungen werden einander gegenübergestellt. Ein neues Modell für Platten mit Kabeln ohne Verbund und zusätzlicher schlaffer Bewehrung wird beschrieben.



1. INTRODUCTION

A brief survey of current practice in the analysis, the design and the construction of prestressed flat slabs is presented. Some new aspects are added. It is not intended however, to give a complete review of the present knowledge in this field. For detailed information the reader is referred to the recommendations [1] and [2] and to the state-of-the-art reports [3] and [4].

Flat slabs are frequently used as structural systems for buildings. The most important advantages are:

- Flexibility for the use in industrial and office buildings, storehouses, schools, etc.
- Minimum height from floor to floor.
- Free headroom for garages and parking structures.
- Reduction of construction time.

Prestressing of flat slabs adds the following advantages:

- Improvement of the deflection and cracking response under service loads.
- Lower costs through the use of high-tensile steel in place of conventional reinforcement.
- Greater span-depth ratio in comparison with conventionally reinforced slabs. The economical spans range from 6 to 15 m.
- Improvement of the punching resistance by placing tendons in the column lines.

The majority of prestressed flat slabs is constructed using unbonded post-tensioned tendons in combination with additional nonprestressed reinforcement. If the slab-thickness exceeds 30 cm bonded multistrands are also used because the loss of effective height becomes acceptable.

For the analysis and the design of prestressed flat slabs the following problems have to be considered: Flexural behavior, shear strength, distribution of the tendons and special detailing problems.

2. FLEXURAL BEHAVIOR

2.1 Generals

Bonded and unbonded prestressed concrete slabs differ essentially in their flexural behavior. Usually applied analysis and design methods can be classified as follows:

- A) Analysis of internal forces with methods based on the theory of elasticity.
Design of cross-sections based on allowable stresses.
- B) Analysis of internal forces with methods based on the theory of elasticity.
Design of cross-sections based on ultimate strength.
- C) Analysis and design with methods based on the theory of plasticity.

2.2 Bonded systems

Bending of bonded post-tensioned slabs may be analysed with the ordinary methods of the elastic or plastic theory for thin plates with small deflection. When using elastic methods to calculate the internal forces the structural design is either based on a comparison between stresses due to service loads and allowable stresses (A) or the ultimate strength of the cross-sections has to exceed the internal forces due to service loads multiplied by a specified safety factor (B). When using plastic methods (C), deformations and cracks under service loads have to be checked by using elastic methods.

2.3 Unbonded systems

Unbonded structures, however, show a different behavior not only at ultimate but also at service loads. Since frictional forces between the tendons and the concrete are negligible, the strain in an unbonded tendon is nearly constant over its entire length. The assumption that the strain distribution over the depth of a cross-section is linear is no longer valid. Hence the application of the analysis and design methods used for bonded systems to unbonded prestressed systems is unsatisfactory. After cracking the concrete forms a compressed shell or arch and the tendons a tension membrane as shown in Fig.1. Therefore, the analysis has to include these two systems.

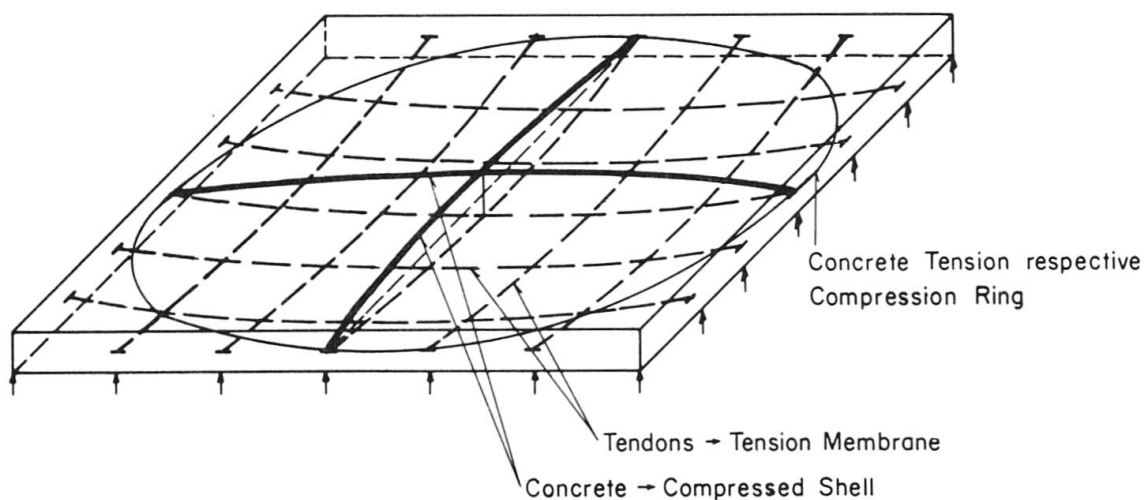

Fig. 1. Static System of Simply Supported Unbonded Post-Tensioned Slab

In present practice, however, unbonded and bonded systems are analysed in a similar way as follows:

Internal forces are analysed with the ordinary elastic theory of plates and corresponding approximate or numerical methods (beam method, equivalent frame method, finite differences and finite elements). The introduction of the transverse component of the prestressing force to balance a portion of the load on the structures leads to the load-balancing method described in [5]. When dealing with statically indeterminate slab systems, the load-balancing method offers considerable advantages. Since the elastic analysis needs to be made only for a fraction of the total load, simple approximate methods may be used without noticeable errors.



The design starting with the elastically calculated internal forces may be done in two different ways. The first approach is based on allowable stresses (A). In this case, the cross-section is stressed by a bending moment and a normal force, the latter being the prestressing force after all losses have been subtracted. In the second approach the ultimate strength of the different cross-sections has to exceed the elastically calculated internal forces multiplied by a specified safety factor (B). Both, the tendon force increase and the effective axial force, needed to calculate the ultimate strength, have to be estimated. The corresponding problem will be discussed later.

A different approach is the use of plastic methods based on either the static (lower-bound) or the kinematic (upper-bound) theorem. To determine the ultimate strength capacity the increase of the tendon force and possible axial forces have again to be estimated.

In addition, either using elastic analysis methods combined with allowable stresses or ultimate strength design or plastic methods, deformations and cracking behavior have to be checked.

Some of the above mentioned requirements are formulated in existing recommendations:

ACI-ASCE Committee 423: "Tentative Recommendations for Prestressed Concrete Flat Plates" [1]:

Permissible stresses:

Permissible tensile stresses in concrete f_{tp} [kg/cm²] at service loads

	positive moments	negative moments
without additional bonded reinforcement	$f_{tp} = 0.53 \cdot \sqrt{f'_c}$	$f_{tp} = 0$
with additional bonded reinforcement	$f_{tp} = 1.59 \cdot \sqrt{f'_c}$	$f_{tp} = 1.59 \cdot \sqrt{f'_c}$

f'_c [kg/cm²]: concrete cylinder compressive strength

Ultimate strength:

Tendon stress increase at design load (ACI 318-71)

$$\Delta f_{se} = 700 \text{ kg/cm}^2 + \frac{f'_c}{100 \cdot \rho}$$

but not more than 4200 kg/cm², where f'_c is the specified compressive cylinder strength of concrete in [kg/cm²] and ρ the reinforcement ratio.

The Concrete Society: "The Design of Post-tensioned Concrete Flat Slabs in Buildings" [2]:

Permissible stresses:

Permissible tensile stresses in concrete f_{tp} :

At transfer: $f_{tp} = 0.77 \cdot \sqrt{f_{ct}}$ unless bonded reinforcement is provided and
 $f_{tp} = 1.53 \cdot \sqrt{f_{ct}}$ with enough added bonded reinforcement to



tension membrane, both connected by a surrounding concrete compression ring. Fig. 2 shows the model of a slab strip. The restraining effect of adjoining panels, edge beams or other resisting elements against horizontal movements is idealized by a horizontal spring. Depending on the tying system of the tendons to the slab the stiffness of the spring acting on the concrete and the tendons can be different. Bending resistance due to bonded reinforcement, frictional forces and flexural rigidity of the concrete is taken into account by a coupled beam. In the analysis of the concrete arch and the steel cable the influence of the deflections (large deflection theory) and the actual stress-strain relationship of both concrete and steel have to be taken into account.

The main objective of this model is to subdivide the strength of an unbonded prestressed slab with additional bonded reinforcement into different parts: Tendon with the upward transverse component of the prestressing force, concrete acting as arch or shell and additional bending action.

The tied-arch model describes the actual behavior of unbonded prestressed concrete members realistically. In the following some important findings will be summarized [8].

Figs. 3 and 4 show the load-deflection relationship of laterally unrestrained and restrained slab strips.

For a laterally unrestrained strip the influence of large deflections does not

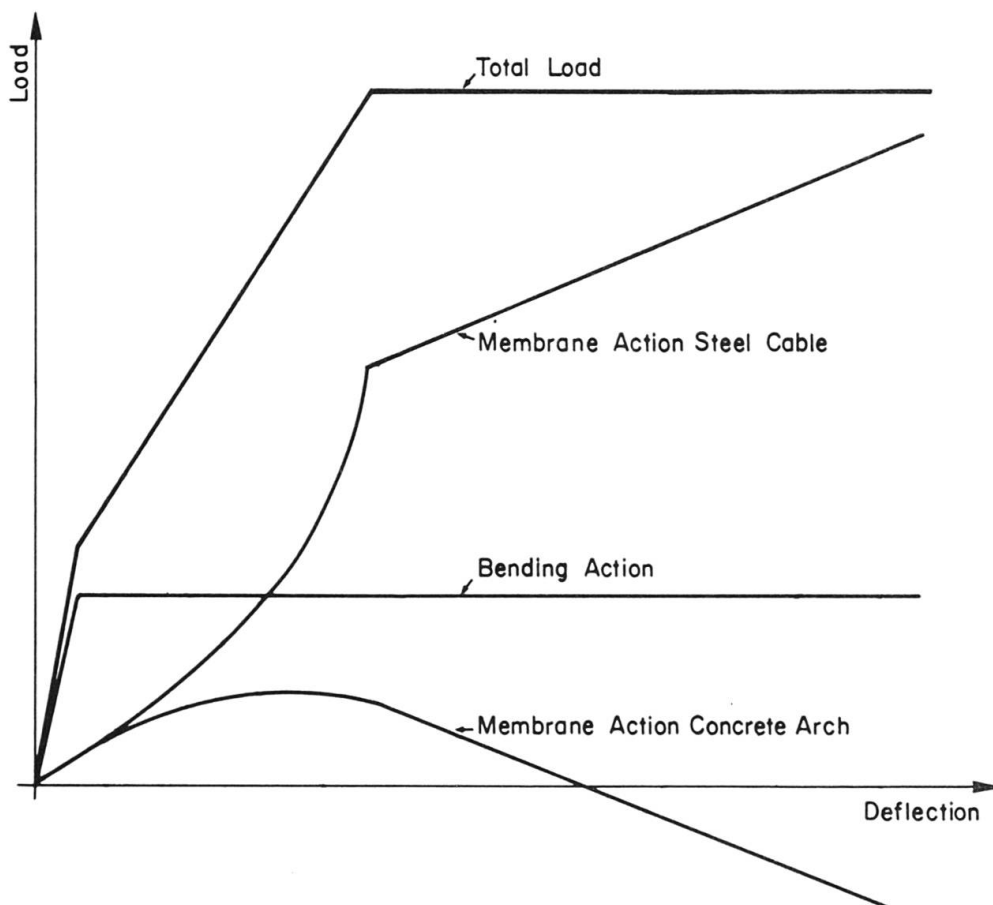

Fig. 3. Different Actions in Laterally Unrestrained Slab Strip

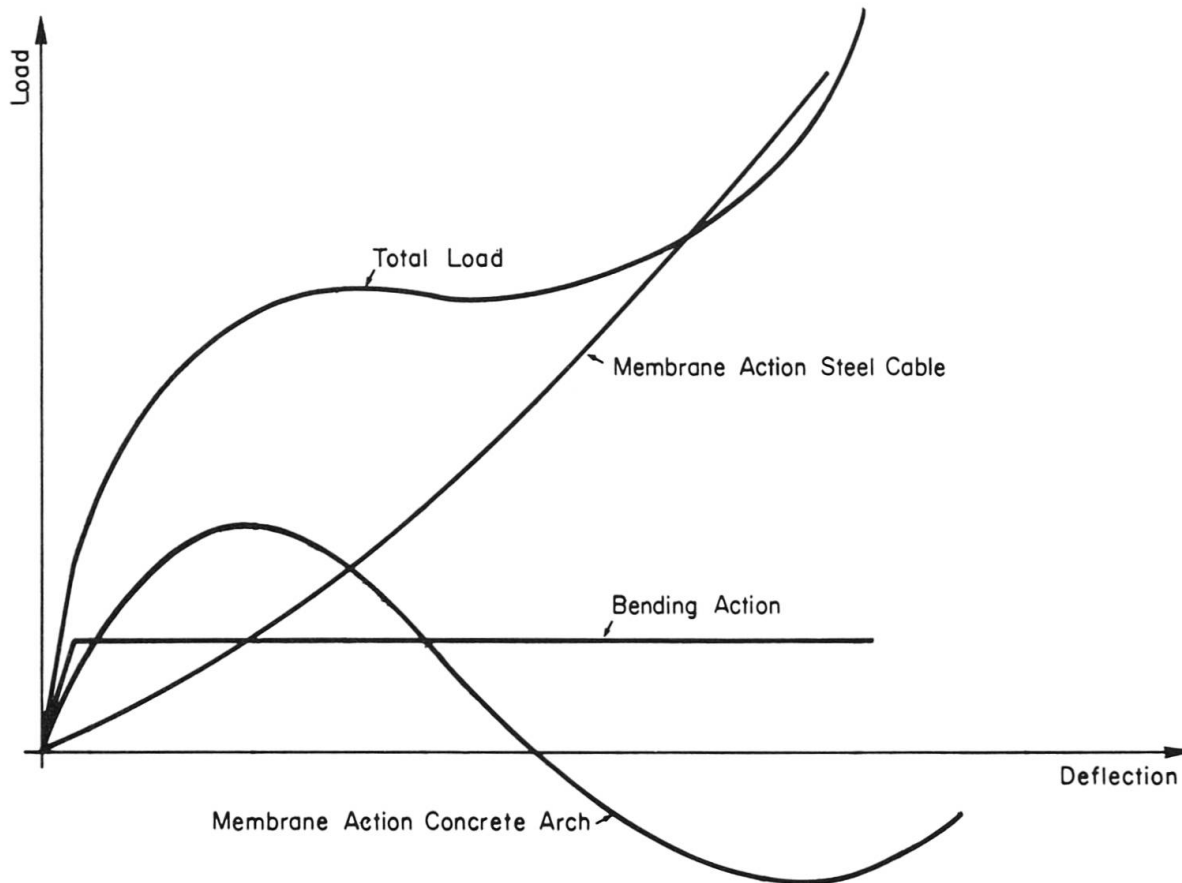

Fig. 4. Different Actions in Laterally Restrained Slab Strip

enter. A laterally restrained slab strip, however, shows a typical snap-through behavior and the ultimate load is much greater, limited only by the strength and total elongation of the tendons.

The tendon stress increase is directly determined by the total change of the tendon length as a function of the deflection and the movements of both ends. If there is no restraint against horizontal movements, the tendon stress increase as function of the midspan deflection depends essentially on the depth to length ratio h/l as shown in Fig. 5. However, if a restraint against horizontal movements exists, the tendon stress increase as function of the midspan deflection is mainly governed by the initial geometry of the tendon, i.e. f_{0S}/l . This is shown for one h/l -ratio in Fig. 6.

The influence of the membrane forces is important not only at failure but also in the state of serviceability. Tests described in [7] show that under service loads the crack pattern and crack widths are similarly influenced by lateral restraint as by additional bonded reinforcement. In a flat slab system, inner panels develop greater lateral forces than edge and corner panels. Hence, more additional bonded reinforcement for edge and corner panels is needed than for inner panels.

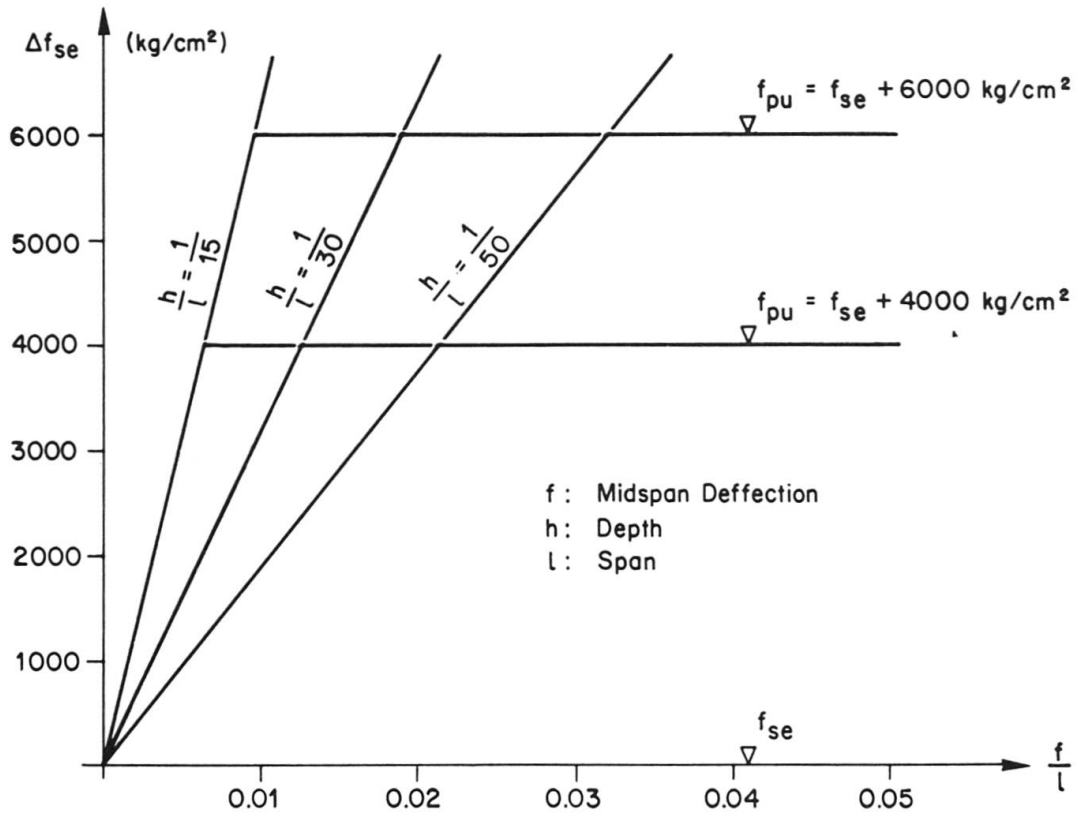

Fig. 5. Tendon Stress Increase in Laterally Unrestrained Slab Strip Assuming a Sinoidal Deflection Curve

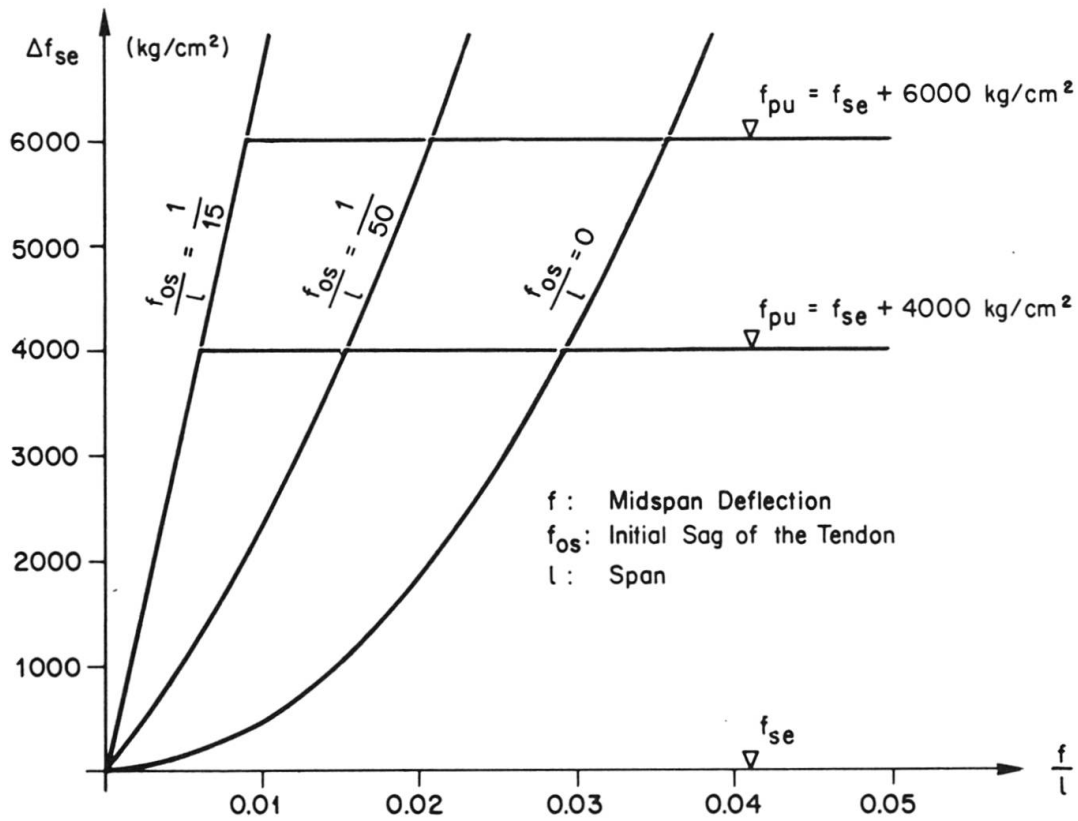

Fig. 6. Tendon Stress Increase in Laterally Fixed Slab Strip Assuming a Sinoidal Deflection Curve

3. PUNCHING

The avoidance of shear failures at slab to column connections is one of the decisive problems for slab systems. While reinforced concrete beams are generally provided with at least a minimum amount of shear reinforcement, no shear reinforcement is placed at slab-column connections in most cases. Thus, after cracking, shear forces must be supported by arch action, aggregate interlock along the cracks and by dowel action of the reinforcing bars. The latter two types of shear transfer are closely connected with the concrete tensile strength and brittle failure is to be expected.

Several shear failures of flat slab structures during construction have been reported, cf. [4]. Sometimes, a progressive collapse of the lower floors or of adjacent structures was caused by the impact of falling material from above. Other failures at slab-column connections occurred in earthquakes. Considering these failures a cautious design approach is highly recommended unless a ductile behavior associated with shear strength is guaranteed.

Numerous investigations on the shear strength of concrete slabs have been conducted [4]. The results of slab-column tests are still the main basis for the present knowledge. Accordingly, most design methods and Code provisions limit a nominal shear stress, v_{nom} , at a critical section around the column to an acceptable value, v_{acc} , determined by tests. This value is predicted to depend on the concrete strength, f'_c , the ratio of flexural reinforcement, ρ , the ratio of the column diameter to the effective slab depth, ξ , and on other variables:

$$v_{nom} \leq v_{acc} = v_{acc}(f'_c, \rho, \xi, \dots)$$

The importance of the different factors is essentially dependent on the special conditions of the respective tests. Sometimes, meaningless values for deviating conditions are the consequence. Apart from these efforts, some authors developed physical models to get an idea of the actual behavior and of the mechanism of punching failure [9 to 11].

Do slab-column tests realistically model the conditions in a slab system? According to the elastic theory of thin plates, the bending moments in the radial direction practically vanish along a circle of radius $0.22 \cdot l$ around the column center for a square panel slab system with span l and columns with small diameter. The slab-column test specimens are usually assumed to represent the area within this circle. They do not allow for the change of the boundary conditions after cracking due to membrane forces and redistribution of moments in the actual slab system. These shortcomings may be avoided by tests on slab systems, e.g. [12]. However, the main object of such tests has mostly been to study the flexural behavior [13]. For these reasons, the interpretation of any experimental data requires proper attention.

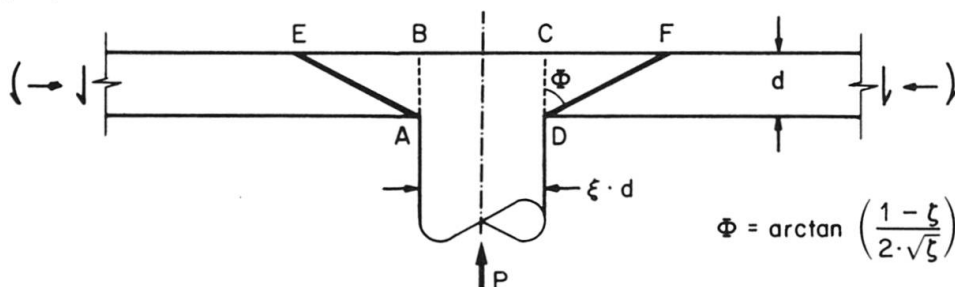

Fig. 7. Punching: Rigid Body Mechanism at Interior Column



Simplifying the reality by assuming that concrete follows Coulomb's yield criterion with the associated flow rule, a rigid body mechanism for the shear failure at an interior column has been stated [14], Fig. 7. If lateral movements are prohibited either by sufficient top reinforcement or lateral restraints a rigid body mechanism by vertical punching of the truncated cone AEFD above the column is possible. The analysis yields the upper bound parameter s_u

$$s_u = \frac{P}{\pi \cdot \xi \cdot d^2 \cdot v \cdot f'_c} = \frac{\sqrt{\zeta}}{2} + \frac{1-\zeta}{4 \cdot \xi}$$

for the collapse load P if there is no shear reinforcement. ζ denotes the ratio of concrete tensile to compressive strength and $v \leq 1$ relates the effective concrete strength or yield level to f'_c . Holes in the column area may affect the surface of the failure cone and accordingly lower the collapse load.

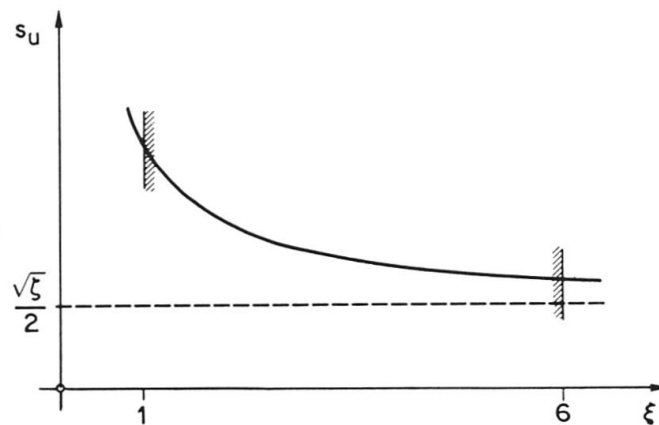
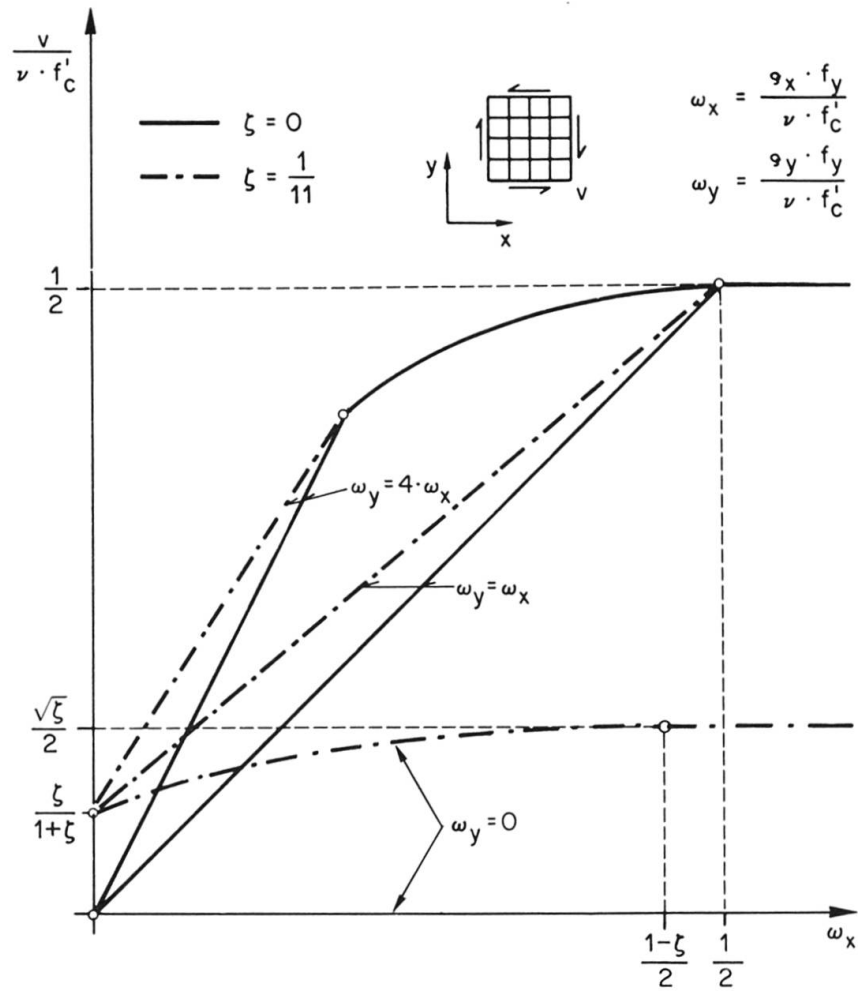

Fig. 8. Effect of the Column Diameter on the Upper Bound s_u

In Fig. 8, s_u is plotted versus the ratio ξ within the practical range $1 \leq \xi \leq 6$. Similar mechanisms may be analysed for any column shape.

Based on the same assumptions as above, Fig. 9 (a) shows the theoretical collapse load of a reinforced concrete disc element for different reinforcement ratios [14]. In Fig. 9 (a) ρ_x and ρ_y denote the reinforcement ratios in the x- and y- directions respectively and f_y is the yield stress of the reinforcement. The corresponding failure mechanisms are indicated in Fig. 9 (b). Laterally restraining stresses have the same effect as the equivalent reinforcement stresses $\rho \cdot f_y$. By means of the upper- and lower-bound theorems of the theory of plasticity, these results may be applied to estimate the shear strength of different reinforced concrete members such as beams, discs, plates and connected elements. Even for complex geometrical and/or loading conditions this procedure provides a clear physical idea of the mode of failure and the magnitude and the interaction of the different types of shear transfer. The lower bound concept is familiar to the civil engineer in the form of the well-known truss model for shear transfer in reinforced concrete beams. Obviously, direct load transfer to the supports may occur for relatively short elements by arch action. For low percentages of main reinforcement the flexural strength controls. In spite of the drastic idealization of the material behavior, designers should be able to estimate the effects of important variables such as concrete strength, column size and shape, reinforcement ratio and lateral restraint.



(a) Shear Strength in Function of the Reinforcement Ratios

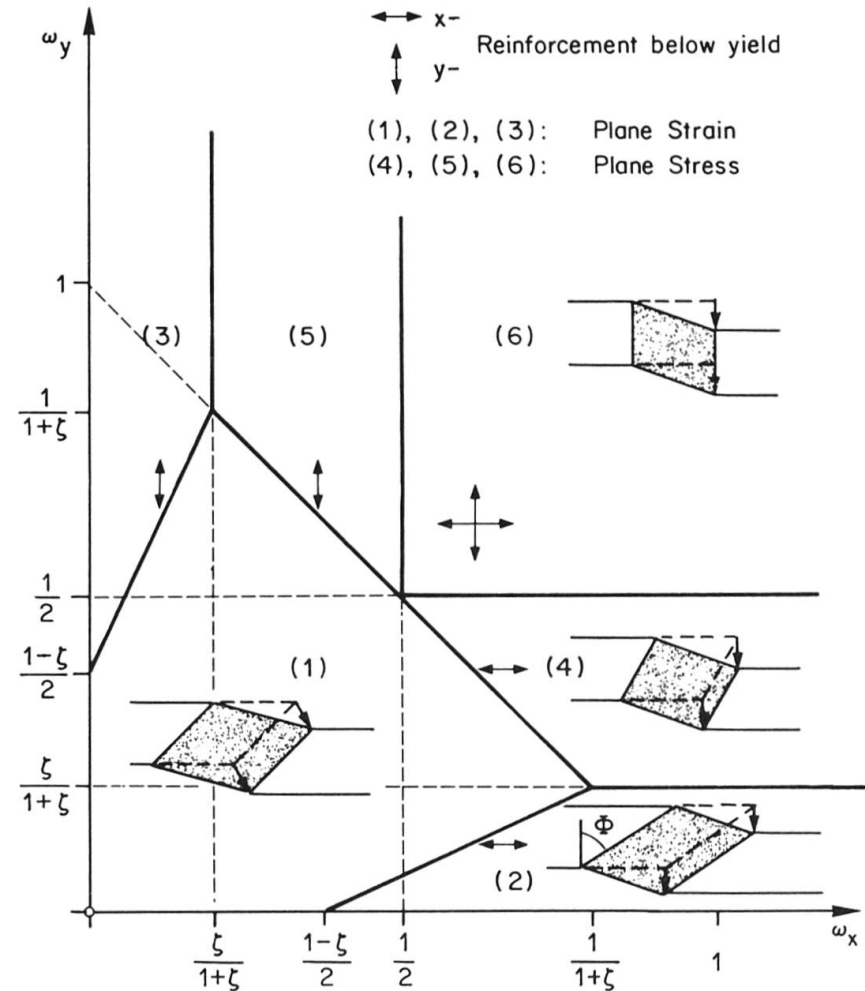

(b) Different Failure Mechanisms

Fig. 9. Shear Strength and Failure Mechanisms of a Reinforced Concrete Disc Element



Real ductility associated with shear strength may be achieved with properly detailed shear reinforcement [15]. Best results are obtained with stirrups that completely enclose the tension and compression reinforcement [4]. Calculations of the shear strength of slabs with shear reinforcement are best based on a beam model, e.g. [16]. The same holds for situations where moments are transferred to interior columns and for edge and corner columns. The basic idea is to idealize the slab sections framing into the column faces as beam sections. The contributions of each beam add up to the total strength of the connection.

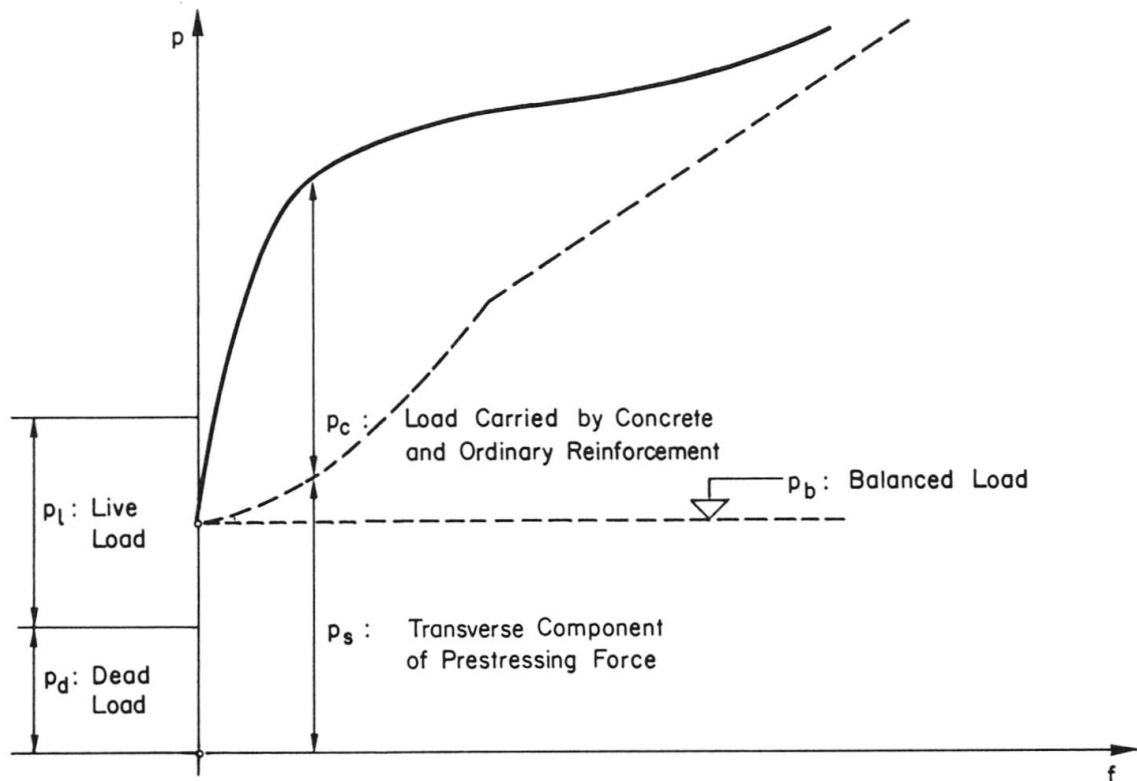

Fig. 10. Schematic Load - Deflection Curve of a Prestressed Flat Slab

In prestressed flat slabs one part of the load, p_s , is transferred to the column by the transverse component of the prestressing force. The remaining part, p_c , is supported as in conventionally reinforced flat slabs, i.e. after cracking by aggregate interlock, dowel and arch action and a possible shear reinforcement (Fig. 10). The value $(p_s - p_b)$ corresponds to the tendon force increase and depends on the flexural behavior of the slab system, as outlined in section 2. If enough tendons are placed over the column heads they may act as a suspension net supplying a favorable behavior for large deflections. If not, shear failure will even be more violent than for a reinforced concrete slab because failure will not be preceded by a warning of flexural cracking. Column areas should always be strengthened with a nonprestressed top reinforcement. It results in a higher shear capacity and better ductility and controls the opening of cracks.

Many questions require more detailed clarification. Further theoretical and experimental work is necessary. Proper analysis of the deformations based on reasonable constitutive relations for concrete and steel should lead to a better understanding of the mechanism of shear failure. General principles governing the behavior of slabs must be taken into account. Tests on slab-column specimens should

incorporate the effect of continuity in the slab system. The layout of tests on slab systems should allow to study the effect of various variables on the flexural as well as on the shear strength.

4. TENDON DISTRIBUTION

In prestressed concrete flat slabs the load transfer by the transverse component of the tendon forces in different directions can be freely chosen. A tendon layout can be found for any assumed distribution of the load transfer. The transfer of loads from an inner point of a slab to the columns is schematically shown in Fig. 11. The load can be transferred by the tendons only or by a combination of

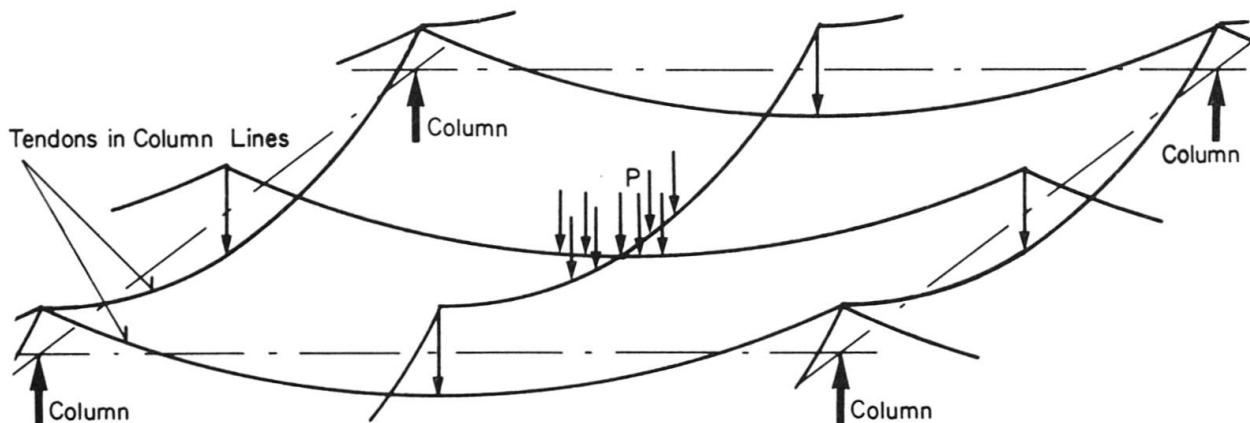

Fig. 11. Scheme of Load Transfer by Tendons

tendons and nonprestressed reinforcement. The load transfer by membrane action of the concrete as shown in Figs. 1 and 2 will not be considered in this chapter.

Four different arrangements of tendons are shown in Fig. 12: tendons placed only in the column lines in one direction (a) or in two directions (b) with ordinary reinforcement in the panels; combined layouts of distributed tendons over the panel and concentrated tendons in the column lines, (c) and (d). The tendons in the column lines act as "hidden beams".

In principle any layout of tendons between 50% uniformly distributed and 50% concentrated in the column lines on the one side and all tendons concentrated in column lines on the other side is possible.

Considering the shear strength at the column it is desirable to place as many tendons as possible over the columns. But the ratio of dead load to service load has to be considered as shown in Fig. 10. The ability to transfer shear by concrete and supplementary bonded reinforcement has also to be taken into account.

The tendon distribution has to be based on the principle that a balanced safety is assured against flexural failure and shear failure giving due regard to economical considerations. Considering balanced safety, ductile or brittle behavior for both, flexural and shear failure, has to be taken into account.

The choice of a tendon arrangement, as shown in Fig. 12, depends also on the

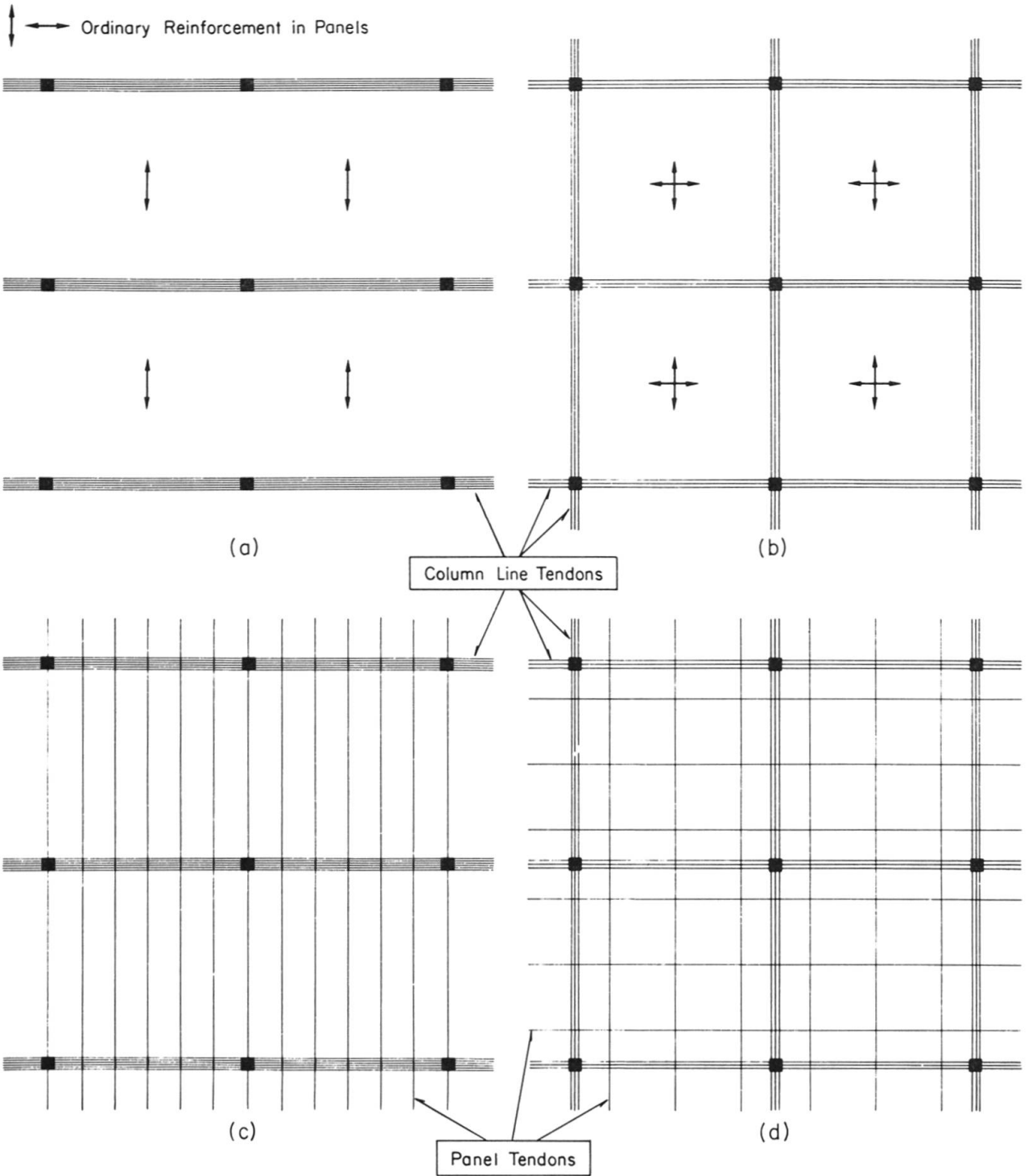

Fig. 12. Layouts of Tendons



detailing of the tendons and statical aspects. For practical reasons tendon crossings as shown in Figs. 12(b) and 12(d) should be avoided. For statical reasons, however, a slab should not bend into a developable, in particular into a cylindrical surface because the slab itself will not evolve a horizontal restraint. The arrangements of Figs. 12(a) and 12(c) are unfavorable in that respect. Obviously a compromise adjusted to the particular situation is necessary.

In an intermediate panel of a uniformly loaded rectangular flat slab, a complete load balancing for both, bending and shear, is only realized if 50% of the tendons are uniformly distributed and 50% concentrated in the column lines as shown in Figs. 12(c) and 12(d).

If the load is carried only by the transverse component of the tendon force, the tendon volume is the same for any simple tendon pattern as described in [17].

5. DETAILING PROBLEMS

Providing higher stiffness under service loads, prestressing of flat slabs actually allows greater slendernesses compared to conventionally reinforced flat slabs. Excessive deflections, unfavorable cracking behavior and undesirable vibrations limit the span-depth ratio.

Horizontal deformations due to prestressing, creep, shrinkage and temperature effects require careful examination. Interaction between slab and restraining elements such as stiff walls and columns must be checked. Depending on the stiffness ratios between slab and restraining elements a part of the prestress is absorbed by the restraining elements. Referring to the discussion in section 2, the horizontal restraint will also influence the development of the membrane force in the concrete shell and the tendons [8]. To avoid overstressing, temporary joints between slab and supporting members or between slab sections are frequently used. Their arrangement depends on the prestressing level, the relative stiffness of the supporting members and the distance between the permanent dilatation joints. The average prestress levels range from about 10 to 25 kg/cm².

It can be expected that corrosion protection of unbonded tendons is equal or better than the protection of bonded tendons. However, other considerations require close attention when comparing slab systems with bonded and unbonded tendons. In the event of a local failure caused e.g. by an explosion or a fire, local failure of an unbonded tendon results in its total loss over the entire length. Total collapse of the structure may be the consequence. Therefore, intermediate anchors should be provided in order to subdivide the system into appropriate sections. In this way an effective increase of the overall structural safety can be gained.

6. CONCLUSIONS

- In the design of flat slabs prestressed with bonded or unbonded tendons two limit states must be observed: limit state of serviceability and limit state of failure. For systems with bonded reinforcement sufficient safety against failure leads generally to a normal behavior relative to cracks and deformations under service loads. For systems without bond, however, the limit state of serviceability often governs.
- In the analysis and the design a differentiation between bonded and unbonded



prestressed systems should be made. Bonded slab systems may be analysed by applying the ordinary elastic or plastic theory of thin plates with small deflection.

- The presently used methods of analysis for unbonded systems are still unsatisfactory. The flat-tied arch model provides a better understanding of the real behavior. In-plane forces are explicitly taken into account. The tendon force increase is primarily a geometrical problem depending on the initial geometry of the system and on the deflection.
- The safety with regard to punching failure is decisively improved by placing enough tendons in the column lines. The design should aim at ductility whenever possible. In the absence of a sufficient shear reinforcement, the concrete strength must judiciously be taken into account. The column area must be covered with properly arranged non-prestressed reinforcement.
- Depending on the dead-live load ratio and the load arrangement an economical layout of the reinforcement results if 50 percent or more of the tendons are placed in the column lines.
- Edge and corner panels as well as the region around the column must be strengthened with additional nonprestressed reinforcement.
- Vertical and horizontal deformations, the cracking behavior and the interaction between the slab and the other structural elements should be carefully checked.
- In order to limit the propagation of a local failure, systems with unbonded tendons should be subdivided into appropriate sections by providing intermediate anchors.
- Unbonded systems, properly detailed, will dissipate considerable energy as a consequence of the large attainable deflections.

References

- [1] ACI-ASCE Committee 423, "Tentative Recommendations for Prestressed Concrete Flat Plates", Journal of the American Concrete Institute, Proceedings, Vol. 71, No. 2, Feb. 1974, pp. 61-71.
- [2] Concrete Society, "The Design of Post-Tensioned Concrete Flat Slabs in Buildings", Concrete Society publication No. 53028, London, 1974.
- [3] Nasser, George D., "A Look at Prestressed Flat Plate Design and Construction", Journal, Prestressed Concrete Institute, V. 14, No. 6, Dec. 1969, pp. 62-77.
- [4] Joint ASCE-ACI Task Committee 426, "The Shear Strength of Reinforced Concrete Members - Slabs", Journal of the Structural Division, ASCE, Vol.100, ST8, Aug. 1974, pp. 1543-1591.
- [5] Lin, T.Y., "Load Balancing Method for Design and Analysis of Prestressed Concrete Structures", Journal of the American Concrete Institute, Proceedings, Vol. 60, No. 6, June 1963, pp. 719-742.



- [6] Schweizerischer Ingenieur- und Architekten-Verein (SIA), "Bruchwiderstand und Bemessung von Stahlbeton- und Spannbetontragwerken", Norm 162, Richtlinie 34. Zürich: SIA 1976.
- [7] Ritz P., Marti P., Thürlimann B., "Versuche über das Biegeverhalten von vorgespannten Platten ohne Verbund", Institut für Baustatik und Konstruktion ETH Zürich, Bericht Nr. 7305-1. Birkhäuser Verlag Basel und Stuttgart, Juni 1975.
- [8] Ritz P., "Biegeverhalten von vorgespannten Platten ohne Verbund", Institut für Baustatik und Konstruktion ETH Zürich, in Vorbereitung.
- [9] Kinnunen S., Nylander H., "Punching of Concrete Slabs Without Shear Reinforcement", Royal Institute of Technology, Transactions No. 158, Stockholm, 1960.
- [10] Kinnunen S., "Punching of Concrete Slabs with Two-way Reinforcement with Special Reference to Dowel Effects and Deviation of Reinforcement from Polar Symmetry", Royal Institute of Technology, Transactions No. 198, Stockholm, 1963.
- [11] Reimann H., "Zur Bemessung von dünnen Plattendecken auf Stützen ohne Kopf gegen Durchstanzen", Dissertation, Technische Universität Stuttgart, 1963.
- [12] Hemakom R., "Strength and Behavior of Post-Tensioned Flat Plates with Unbonded Tendons", Dissertation, The University of Texas at Austin, 1975.
- [13] Hawkins N.M., Criswell M.E., Roll F., "Shear Strength of Slabs Without Shear Reinforcement", American Concrete Institute, SP-42, Shear in Reinforced Concrete, Detroit, 1974.
- [14] Marti P., Thürlimann B., "FlieSSbedingung für Stahlbeton mit Berücksichtigung der Betonzugfestigkeit", Beton und Stahlbetonbau, Vol. 72, No. 1, Jan. 1977.
- [15] Carpenter J.E., Karr P.H., Hanson N.W., discussion of "Proposed Revision of ACI 318-63: Building Code Requirements for Reinforced Concrete", Journal of the American Concrete Institute, Proceedings, Vol. 68, No. 9, Sept. 1970, pp. 696-697.
- [16] Hawkins N.M., "Shear Strength of Slabs with Moments Transferred to Columns", American Concrete Institute, SP-42, Shear in Reinforced Concrete, Detroit, 1974.
- [17] Rozvany G.I.N., Hampson A.J.K., "Optimum Design of Prestressed Plates", Journal of the American Concrete Institute, Proceedings, Vol. 60, No. 8, Aug. 1963, pp. 1065-1082.
- [18] Stamm K., Kaegi R., "Vorgespannte Flachdecken im Lagerhaus Schöntalhof, Rapperswil", Schweizerische Bauzeitung, 91. Jahrgang, Heft 49, 6. Dez. 1973, pp. 1191-1196.

Leere Seite
Blank page
Page vide