

**Zeitschrift:** IABSE congress report = Rapport du congrès AIPC = IVBH  
Kongressbericht

**Band:** 14 (1992)

**Rubrik:** Plenary session 1: New horizons in structural engineering

### **Nutzungsbedingungen**

Die ETH-Bibliothek ist die Anbieterin der digitalisierten Zeitschriften auf E-Periodica. Sie besitzt keine Urheberrechte an den Zeitschriften und ist nicht verantwortlich für deren Inhalte. Die Rechte liegen in der Regel bei den Herausgebern beziehungsweise den externen Rechteinhabern. Das Veröffentlichen von Bildern in Print- und Online-Publikationen sowie auf Social Media-Kanälen oder Webseiten ist nur mit vorheriger Genehmigung der Rechteinhaber erlaubt. [Mehr erfahren](#)

### **Conditions d'utilisation**

L'ETH Library est le fournisseur des revues numérisées. Elle ne détient aucun droit d'auteur sur les revues et n'est pas responsable de leur contenu. En règle générale, les droits sont détenus par les éditeurs ou les détenteurs de droits externes. La reproduction d'images dans des publications imprimées ou en ligne ainsi que sur des canaux de médias sociaux ou des sites web n'est autorisée qu'avec l'accord préalable des détenteurs des droits. [En savoir plus](#)

### **Terms of use**

The ETH Library is the provider of the digitised journals. It does not own any copyrights to the journals and is not responsible for their content. The rights usually lie with the publishers or the external rights holders. Publishing images in print and online publications, as well as on social media channels or websites, is only permitted with the prior consent of the rights holders. [Find out more](#)

**Download PDF:** 04.04.2026

**ETH-Bibliothek Zürich, E-Periodica, <https://www.e-periodica.ch>**



## **Plenary Session 1**

### **New Horizons in Structural Engineering**

**Nouvelles frontières dans les constructions de génie civil**

**Herausforderungen an den konstruktiven Ingenieurbau**

Organizer:            Michel Virlogeux,  
                                 France

Leere Seite  
Blank page  
Page vide

## Perspective from a Developing Country in Asia

Perspective d'un pays en voie de développement en Asie

Perspektive aus einem Entwicklungsland in Asien

### **C.R. ALIMCHANDANI**

Chairman and Man. Dir.  
STUP Consult Ltd  
Bombay India



C.R. Alimchandani leads an internationally renowned Structural, Civil and Architectural Engineering firm working in West, South and South East Asia. An active member of national and international code committees, his recognition for professional achievements include the Architectural Engineering Design Award of the Institution of Engineers, India, the FIP Medal and the ACTIM medal, France

### **SUMMARY**

The challenge for the engineer is far greater in a developing country than in an industrialised nation, paucity of funds, restricted imports, high material costs, outmoded equipment and a largely labour-intensive industry. Therefore, he has to use local resources and skills to their fullest without compromising on safety and durability. Some Indian engineers have successfully used this integrated approach encompassing design and construction engineering to build major structures in a wide variety of fields. They have helped foster an indigenous tradition of excellence in the Indian construction industry which is amongst the five largest in the world.

### **RÉSUMÉ**

Le défi pour un ingénieur est plus grand dans un pays en voie de développement que dans un pays industrialisé, le manque d'argent, importations limitées, coûts élevés des matériaux, vieux matériel et industrie basée sur l'utilisation d'une main-d'œuvre bon marché. C'est pourquoi il doit utiliser les ressources locales et le potentiel humain au maximum, sans toutefois, compromettre la sécurité et la durabilité des ouvrages. Quelques ingénieurs indiens ont appliqué avec succès cette méthode intégrée pour réaliser de grands ouvrages dans divers domaines. Ils ont ainsi aidé au développement de nouvelles traditions d'excellence, bien adaptées aux conditions locales, dans une industrie de la construction qui compte parmi les cinq plus grandes du monde.

### **ZUSAMMENFASSUNG**

Die Herausforderung für einen Ingenieur ist in einem Entwicklungsland grösser als in einem Industrieland: Mangel an Geld, Importbeschränkungen, hohe Materialkosten, veraltete Einrichtungen und eine weitgehend arbeitsintensive Industrie. Also muss er die örtlichen Mittel und Fähigkeiten maximal ausnützen, ohne die Sicherheit und Dauerhaftigkeit zu beeinträchtigen. Er muss auch Bauverfahren entwickeln, Einrichtungen entsprechend dem örtlichen Produktionsstandard entwerfen und unerfahrene Bauunternehmer ausbilden. Einige indische Ingenieure haben dieses integrale Vorgehen in Entwurf und Bauverfahrenstechnik erfolgreich genutzt, um auf verschiedenen Gebieten bedeutende Bauwerke zu schaffen. Dank Ihnen weist die indische Bauindustrie, die zu den fünf grössten der Welt zählt, ihr eigenen Qualitätsmerkmale auf.



It is a great honour for me to address the fourteenth congress of the IABSE. This congress is being held for the first time in a developing country and it is appropriate that India has been chosen as the venue for this historic occasion.

Today, the Indian construction industry is amongst the five largest in the world and at the current rate of growth, it is slated to be amongst the top two in the next century. It has not only achieved international standards, but is also successfully participating in the development process of other developing countries - often in direct competition with the industrialised nations. There have been noteworthy achievements in a plethora of fields; energy and power, water resources, hydraulic and irrigation structures, ports and harbours, road, rail and air transportation, industrial structures and urban and rural development. It is important to note that all this has been accomplished without significant assistance from the developed world.

The problems of the construction industry in a developing country like India are very different from those in a more industrialised nation. There is a tremendous need for construction because of the vast unfulfilled requirements of the population, but funds are scarce and economy is of utmost importance. Foreign exchange limitations restrict the import of material, equipment and technology. Construction materials like steel and cement are expensive, construction equipment is scarce and the industry is labour intensive - yet the same major structures have to be built as elsewhere in the world.

The engineer cannot resolve these problems by directly transplanting technology from the West. He has to search for solutions which are truly responsive to the local environment and the needs of the country.

The task for the engineer in a developing country is therefore far more difficult than for his counterpart in the developed world. He has similar challenges in terms of the complexity and magnitude of structures required, natural phenomena and adverse climatic conditions, but due to the constraints described above, the extent of his responsibility is much wider and he has to be an expert in many fields. He has to have a thorough understanding of materials, both their behaviour and availability, in order to use locally available resources to their fullest potential. He has to be familiar with state-of-the-art knowledge and analytical techniques and use them to create innovative solutions that are economic and yet respect the local environment. As materials typically comprise 75% of the overall cost, he tends to use thin sections and complex geometries requiring labour-intensive procedures, but he may have to train the work force himself. Often, he also has to innovate in construction methodology, design construction equipment and support inexperienced contractors during construction. The challenges he faces are in many ways akin to those that confronted the pioneers in Europe who developed new technologies like prestressed concrete in the 30's and 40's. And what is most important, he has to achieve the highest level of safety and durability because the country can ill afford a failure or a replacement.

To face this challenge, the engineer has to use an integrated and holistic approach covering design and construction engineering which respects the construction and economic environment of the country. Indian engineers have been successful in such an integrated approach and I will demonstrate this through the work of a team of engineers at STUP Consultants Limited. I will focus on developments in two specific areas - containments for nuclear power plants and bridges.



India's first indigenously engineered nuclear reactor building was started in 1963 and today the fifth generation of reactors are under construction. With many more on the drawing board, India is one of the few countries in the world which is still actively advancing the development of nuclear power.

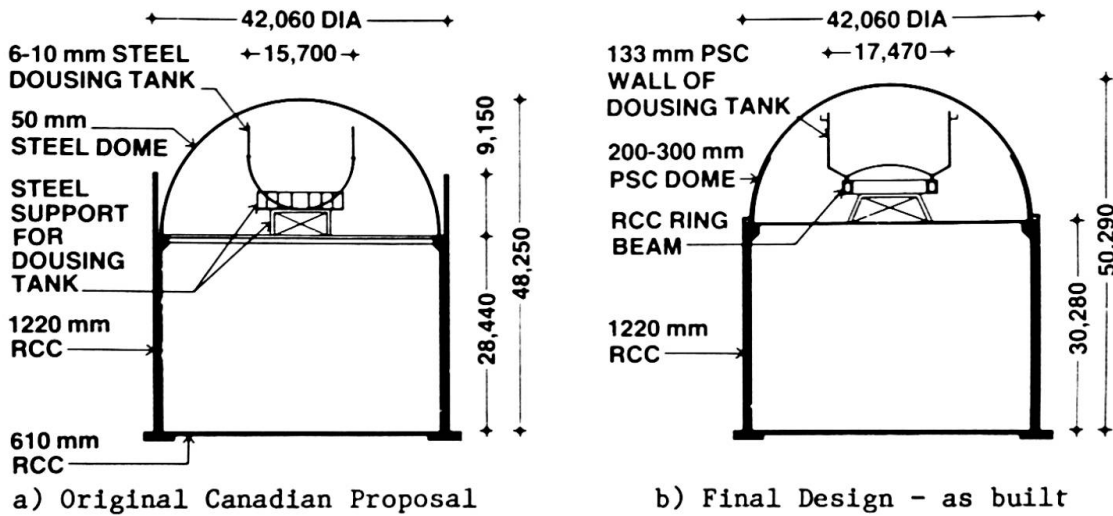

Fig.1 Rajasthan Atomic Power Project

The first nuclear reactor was built with Canadian technical assistance. The original Canadian proposal involved a hemispherical steel dome and a concrete crown wall for radiation protection (Fig. 1a). The entire dome would have had to be imported from Canada in pressed segments. Even the remaining large scale welding and radiography testing on site would have been a formidable task. A search was made for an alternate design, and the reactor, as constructed, involved one of the first uses of prestressed concrete in a containment structure (Fig. 1b). Pioneered by the French, this concept consists of a crack-free concrete enclosure and an inner layer of PVC paint for leak

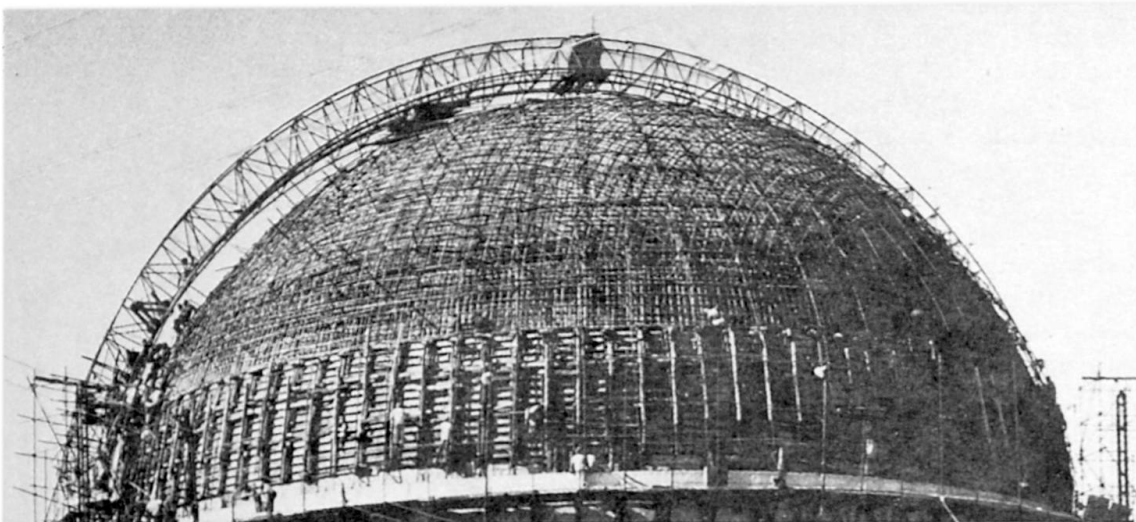

Fig.2 Mobile scaffolding for hemispherical dome

tightness. Also, by thickening the lower portion of the dome, the need for a concrete crown wall was eliminated. The steel dousing tank used to lower temperatures in the event of an accident was also replaced by a prestressed concrete tank. The construction materials required were available locally and



the construction procedure selected involved a simple mobile scaffolding (Fig. 2) which allowed workmen access for both reinforcing and concreting without mechanisation (Fig. 3). It should be noted that a thin hemispherical dome of varying thickness, with complex reinforcing and shuttering on both sides, could only be feasible in a country like India with its abundance of skilled artisans and craftsmen.

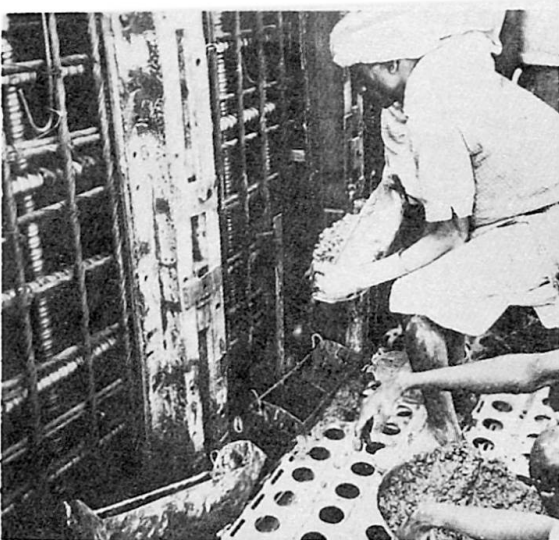

Fig.3 Manual pouring of concrete

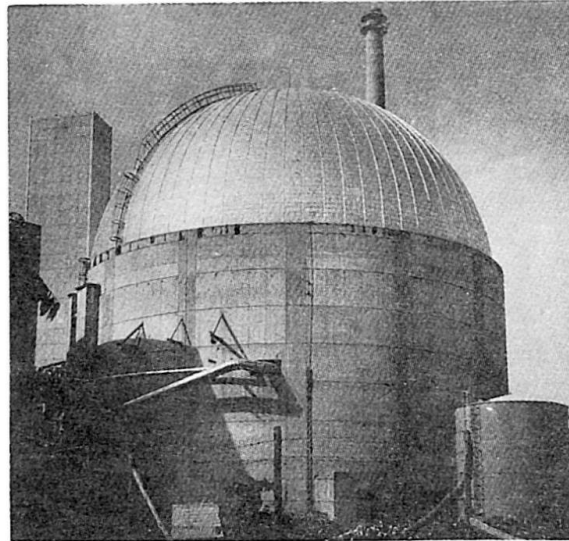

Fig.4 Completed reactor with aluminium cladding

In the next generation of containments, India achieved a quantum leap in safety by pioneering the concept of a double containment (Fig. 5). The inner prestressed concrete containment provides a leaktight environment which can withstand the design internal pressures and the outer wall provides a second barrier and additional radiation protection. The annular space between the containments can be maintained at below atmospheric pressure to aspirate any leakage in an accident. The outer wall also protects the inner containment from rain, wind and sun, reduces the risk of corrosion and provides a barrier for external objects such as aircraft and wind borne missiles in tornadoes. The dousing tank was no longer required because the prestressed containment was designed to withstand much higher internal temperature and pressure than the previous reinforced concrete containment. Another interesting aspect of this reactor is the roof surfacing. Instead of rock wool insulation with aluminium cladding as in the first reactor (Fig. 4), an inexpensive design using local materials was adopted; brick-bat coba faced with china mosaic. The painstakingly hand rammed brick bat coba resulted in a dense waterproof surface and the china mosaic provided a reflective surface which also helped distribute cracks to minimise the danger of seepage.

Note that there is extensive use of stone masonry in this structure - the entire outer containment is of

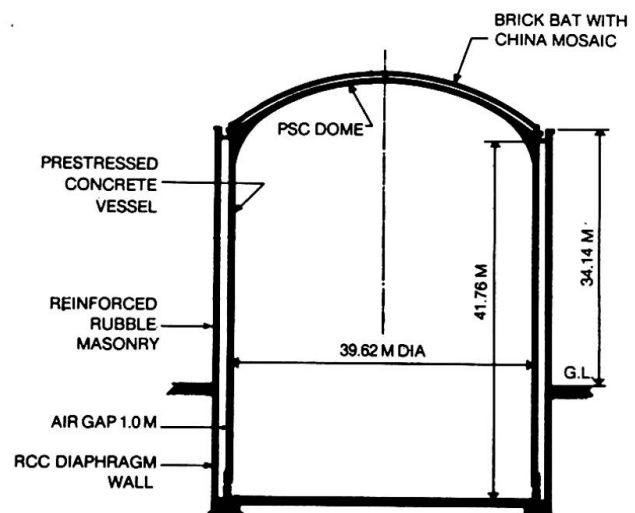

Fig.5 Madras Atomic Power Project

reinforced masonry. This is because stone is readily available in the area and because the local workmen are very skilled in stone work. The outer containment is unique in that it is the only instance of a 35 m. tall, 71 cm. thick, free standing cylindrical shell made of reinforced masonry (Fig. 6).

In the third generation, the double containment concept was taken further by restricting the inner prestressed concrete containment to primarily the radioactive source of energy and placing the other large source of energy, the steam generators, outside it, but within the outer reinforced concrete containment (Fig. 7). An independent safety valve in the outer containment (blow-out panels) for boiler related accidents eliminated high pressure rise. The slab separating the radioactive source from



Fig.6 View of completed reactor, Madras

the generators was designed as a cellular grid. This simultaneously satisfied the structural requirement for a high moment of inertia and the need to reduce mass in order to minimise seismic forces. The lower flange of the slab was prestressed to ensure that the enclosure for the radioactive source was crack-free. Although this design involved a tremendous effort in terms of formwork,

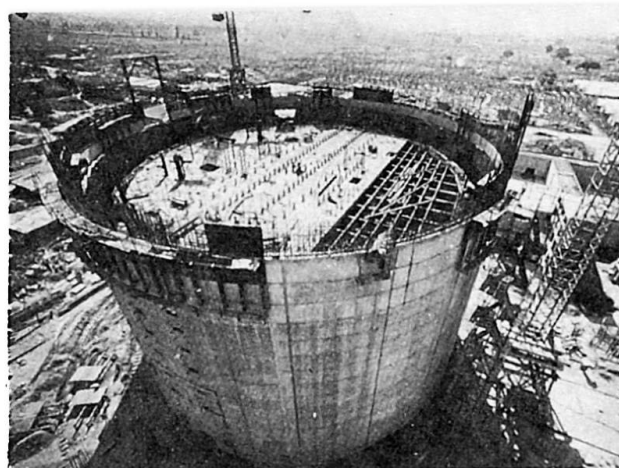
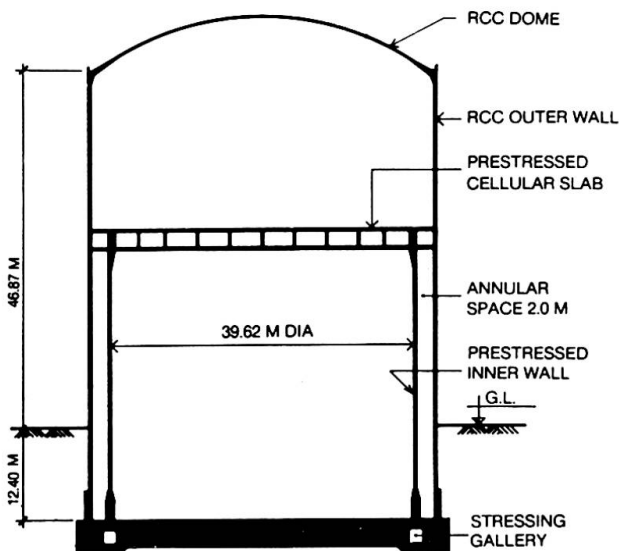

Fig.7 Narora Atomic Power Project

reinforcing and concreting, it was very economical. Note that while the earlier designs only had a single protective layer above the radio-active source, this design has a complete double enclosure. Furthermore, the annular space between the containments and the voids in the slab are permanently maintained at negative pressure in order to minimise the danger of leakage.

In addition to the ongoing improvements in safety, the next generations of



reactors also saw a focus on standardisation and ease and rapidity of construction (Figs. 8 & 9). The availability of large cranes allowed operations such as introducing and removing the steam generators through ports in the roof. At Rajasthan (Fig. 9), the double containment was extended to the entire reactor. Testing and qualification procedures were established to allow use of new improvements in technology, e.g. larger prestressing strands and anchorages. With the increased availability of heavy equipment and construction material and with the growing international consensus on reactor design, these new reactors share many features with their western counterparts.

Stringent safety requirements have required scale model testing and proof loading as well as designing for 1000 year winds, extreme events involving dam failures upstream and resulting floods and earthquakes of 10,000 years return period in regions of seismic activity. Due to increased air traffic, studies include non-linear analysis of the outer containment for aircraft impact.

Today, with the increased need of power due to a booming industrial sector, and restrictions on import of oil, India has decided to expand its nuclear power programme. To meet the growing international concern for safety of the environment, the country is committed to making nuclear power even safer. As accidents are very rare events, use of traditional methods is inadequate and extensive use of probabilistic techniques is required. Probabilistic risk analysis can be used to quantify overall safety and identify any existing weak links. Systems reliability analysis can be used to identify critical variables and components which can then be subject to the strictest quality control and testing.

India, with its major rivers, mountainous terrain, coastal waterways and marine crossings has always held tremendous challenge for the bridge engineer. There have been numerous pioneering innovations and many major bridges have been built. However, the durability of these bridges has become an important concern, especially since some relatively new bridges have shown signs of severe corrosion.

The issue of durability is not only a concern for India, but is currently a pressing concern across the world because many new bridges have shown

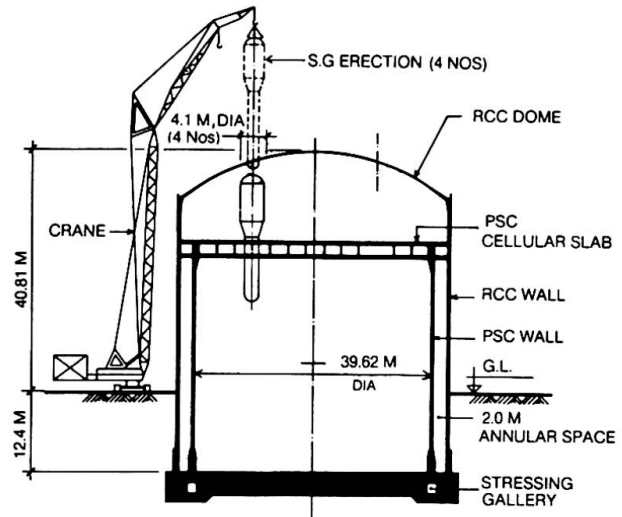

Fig.8 Kakrapar Atomic Power Project

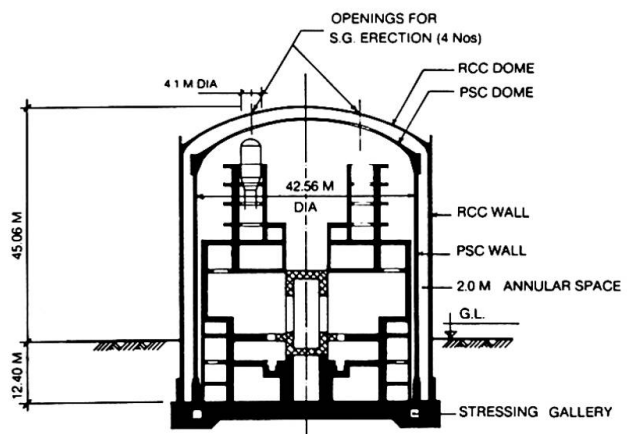

Fig.9 Rajasthan Atomic Power Project  
- Phase II



unexpected distress and innumerable old bridges require retrofitting and replacement. The solutions that are suited for the Indian environment, however, are quite different from those for more industrialised countries and in this section I will describe some of the innovations being used in three major bridges that are currently under construction.

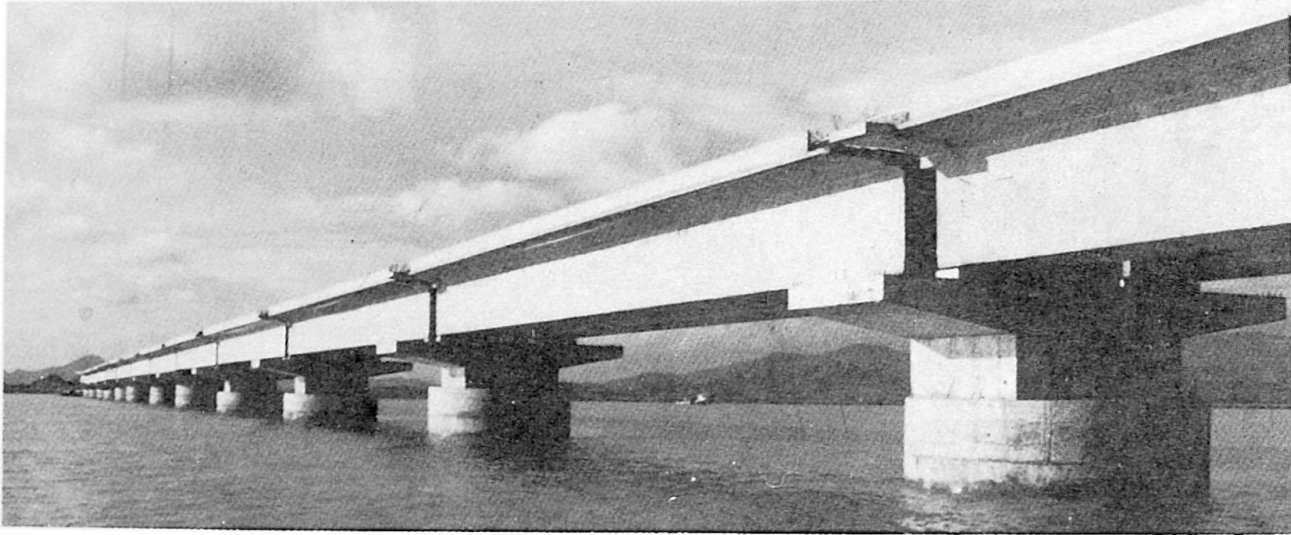

Fig.10 Railway bridges across Vasai Creek

The Vasai Creek rail bridge connects the northern tip of Bombay with the mainland (Fig. 10). It is 2.0 km. long and the 48.5 m. spans consist of two parallel box girders, each carrying a broad gauge railway line. To improve the quality of construction and adhere to the strictest quality control, the box girders were precast and prestressed on shore. In order to prestress them, a ballast of 180 tons had to be added bringing the total weight of each girder to be lifted to 750 tons. To minimise the need for specialised equipment such as heavy cranes, an ingenious construction scheme that used tidal variations to place the girders was developed.

The girders are cast on elevated beds alongside a jetty. After loading of the ballast and prestressing, the girders are shifted to the end of the jetty (Fig. 11). A 1000 ton pontoon is brought below the girder at low tide and as the tide rises the girder is lifted off the jetty. The girder is transported to the site (Fig. 12) and lowered in position using the receding tide (Fig. 13).

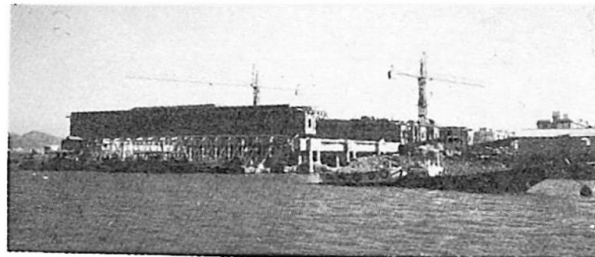

Fig.11 Box girders at edge of jetty

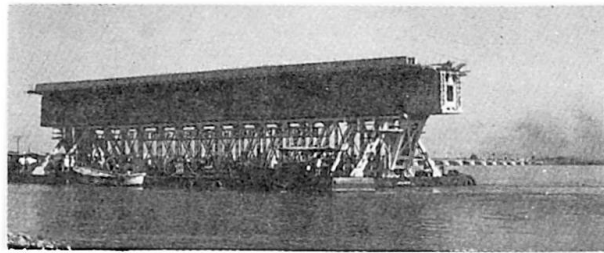

Fig.12 Box girder being towed to site

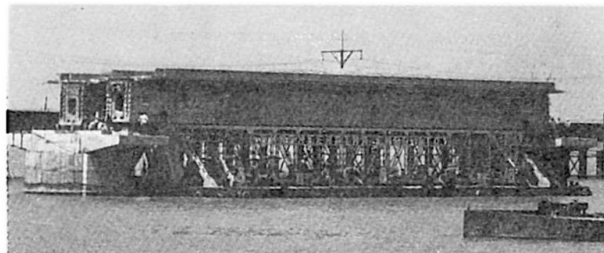

Fig.13 Box girder lowered onto piers



Meticulous planning of the entire construction sequence by the engineers made it possible to introduce standardisation and achieve high levels of productivity while maintaining excellent standards of construction and quality control. In fact, even though the stacking yard could only accommodate three girders at a time, upto seven girders were being cast per month.

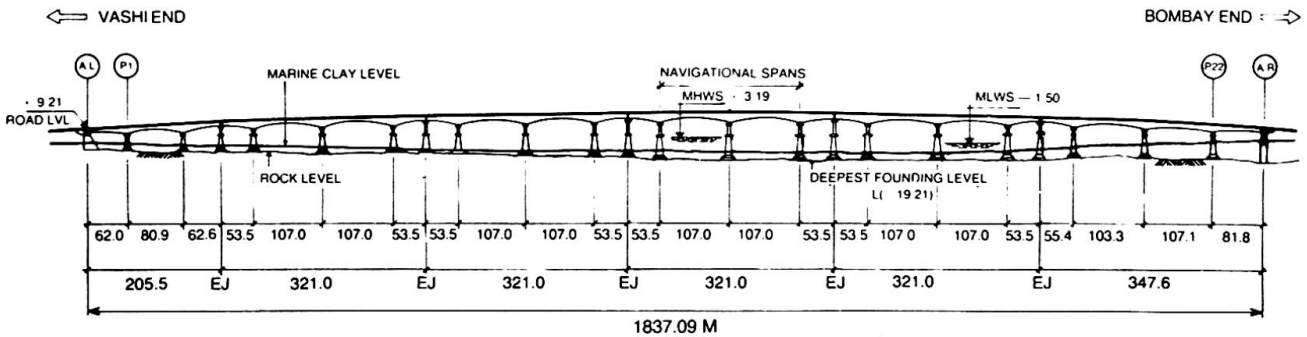
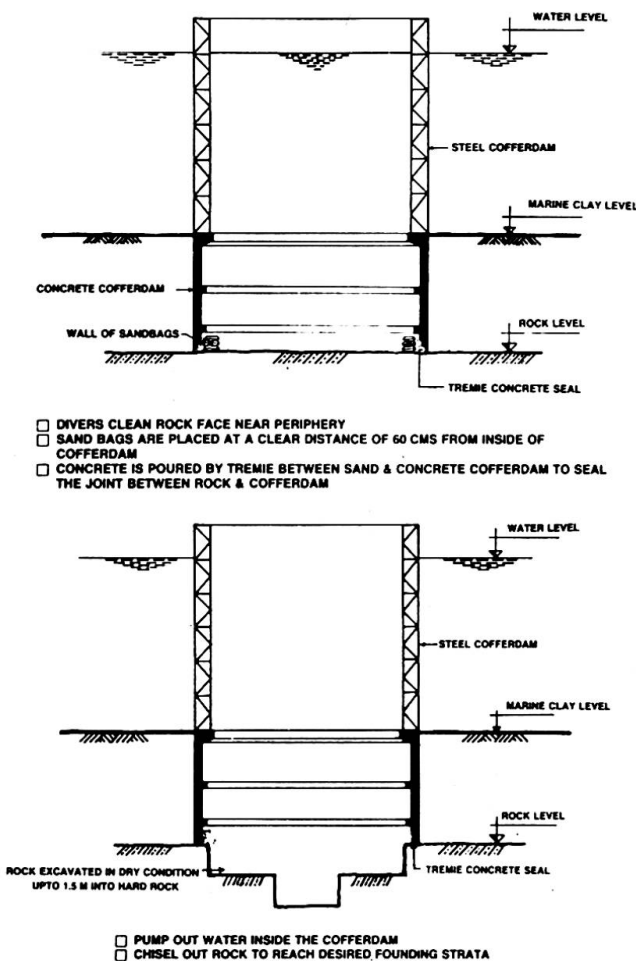

Fig.14 Second Road Bridge across Thane Creek

The existing Thane Creek Bridge connecting Bombay to the mainland is being substantially derated within 15 years of construction due to excessive corrosion. The new 1.8 km. long six lane bridge with 107 m. spans (Fig. 14) is therefore being engineered with extreme care. The foundations which are some times as deep as 22.5 m. below high tide level are of special concern and they are being built in a dry environment in order to ease construction and improve quality.



An innovative cofferdam is being used to construct these open foundations (Fig. 15). It is made up of a lower concrete section of height equal to the overburden (thickness of 300mm and with stiffening ribs every 2 m) surmounted by a reusable cellular steel portion of variable height (made up of 2 m segments). The concrete portion is precast on a pontoon close to shore and some of the steel sections are attached to it using foam rubber gaskets to ensure water-tight joints. The cofferdam is towed to its final location on a catamaran and sunk

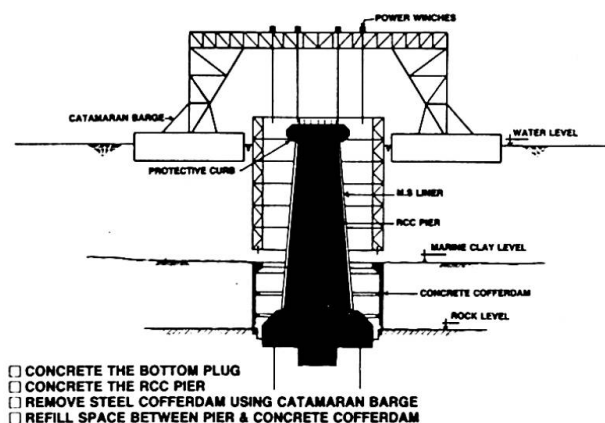

Fig.15 Open foundations at Thane Creek

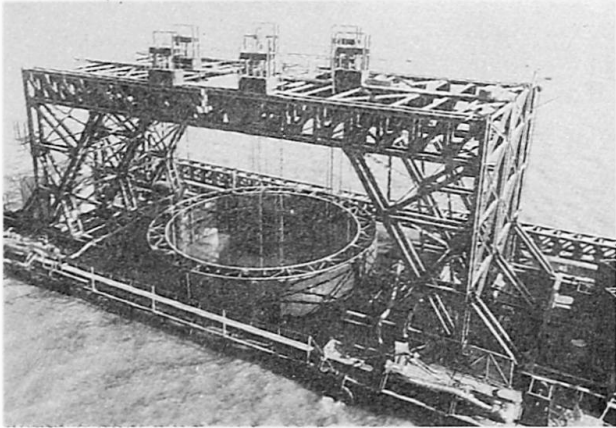

Fig.16 Towing and lowering of cofferdam



Fig.17 Excavation in dry environment

by ballasting the cellular steel portion with water (Fig. 16). Further sinking to the rock level is carried out using grabs mounted on pontoons. Thereafter, divers clear the rock face near the periphery and place sand bags at a clear distance of about 60 cms from the inner face of the cofferdam, a tremie is used to pour concrete into the gap between the sand bags and the cofferdam, thereby creating a watertight seal between the rock face and the cofferdam. Water is pumped out of the cofferdam and the foundation is constructed in a dry environment (Fig. 17). In cases where the rock is extensively fissured, a 1.5 m. deep concrete plug is constructed.

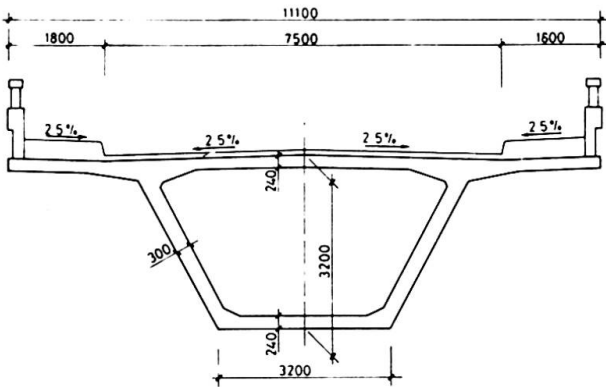

Fig.18 Representative midspan cross-section at Bhagalpur

In all these bridges, extreme care has been bestowed on detailing and construction methodology. Of special interest is the detailing of the webs of the box girders. As seen in the case of the 4.5 km. long bridge across the Ganges at Bhagalpur (Fig. 18), the webs are very thin and economical. This is because there are no prestressing cables in the webs except at small thickened zones at the ends. The absence of prestressing cables in the webs also makes them easier to construct and therefore more durable. Most of the prestressing cables are anchored just below the top slab or just above the bottom slab at their junctions with the webs. The resulting almost straight cable profiles and avoidance of grouping of cables simplifies threading and grouting. Furthermore, locating the cable anchorages below the waterproof top slab and inside the box prevents the ingress of moisture during service and thereby reduces the risk of cable corrosion.

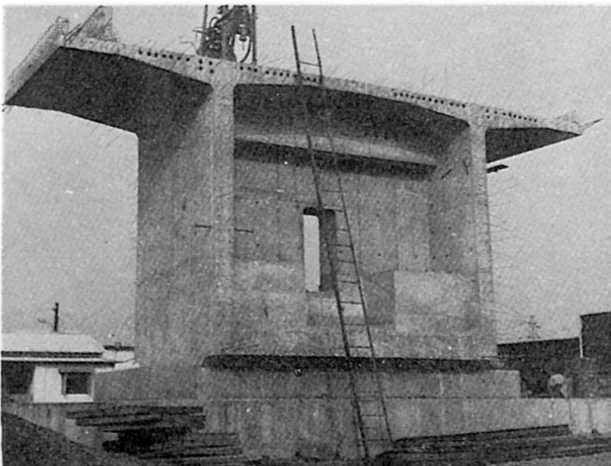

Fig.19 Mock-up of box girder section

The details of concreting such complex sections were carefully studied at Thane Creek and full scale mock-ups were constructed (Fig. 19). The mock-ups were tested and demolished in



order to examine dimension tolerances relating to concrete sizes, locations of reinforcement and concrete cover and also to verify proper compaction of concrete at all locations. Windows were also provided in the webs during construction in order to insert needle vibrators for better compaction and to permit quality assurance.

Note that simplifying the layout of the prestressing cables, appropriate positioning of the anchorages, improving the ease of construction and maintaining strict quality control all combine to give a very durable superstructure. This integrated approach is in contrast to practice in developed nations where durability is often improved by a single, typically expensive, measure such as use of external prestressing cables. However, the integrated approach is equally effective and in this particular case, especially advantageous, as it resulted in reducing material costs.

As mentioned earlier, for this address, I have restricted myself to these two specific areas of nuclear containments and bridges. However, I would like to mention that this integrated approach has been successfully applied to many other areas of civil engineering including cooling towers (Fig. 20), airport hangars (Fig. 21), ports and harbours (Fig. 22), irrigation and hydraulic structures (Fig. 23), public buildings (Fig. 24), industrial complexes (Fig. 25) and dams (Fig. 26).

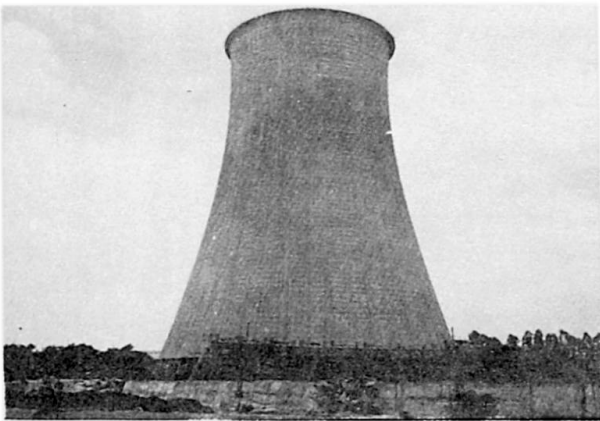

Fig.20 Cooling tower, Gandhinagar



Fig.21 Indian Airlines Hangar, Bombay

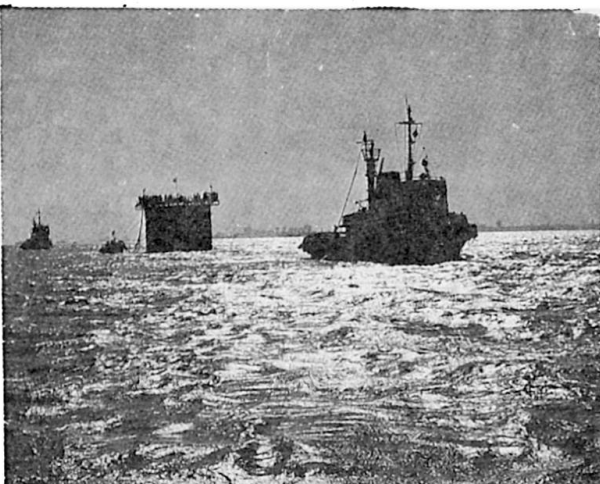

Fig.22 Towing caisson for oil jetty at Butcher Island

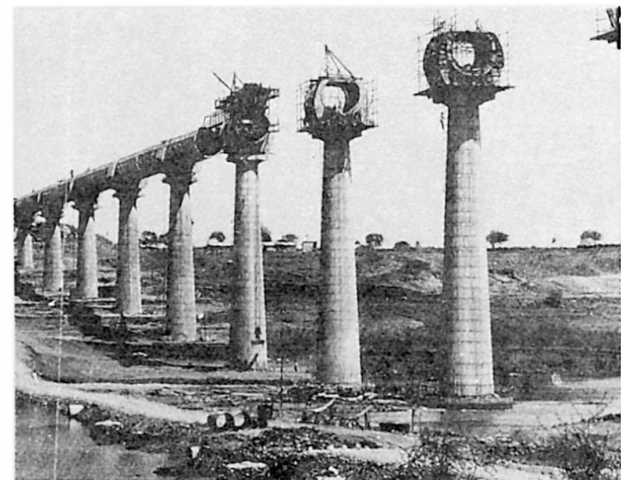

Fig.23 Aqueduct across river Bhima



Fig.24 Assembly hall, Gandhinagar

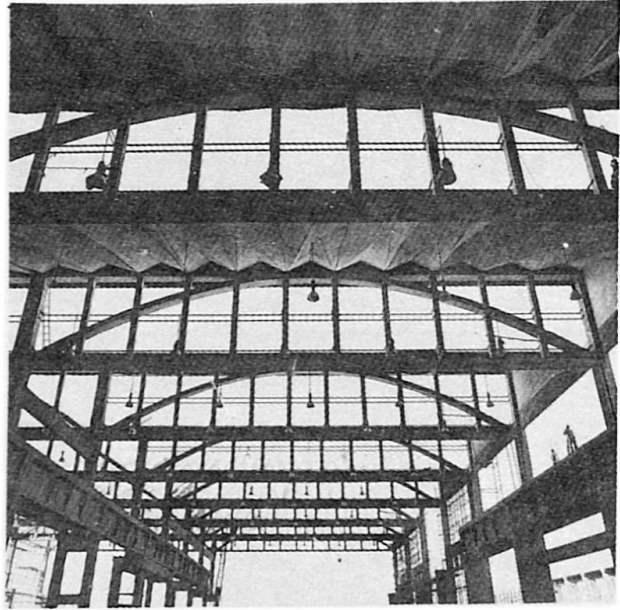

Fig.25 Wheel and Axle Plant, Bangalore

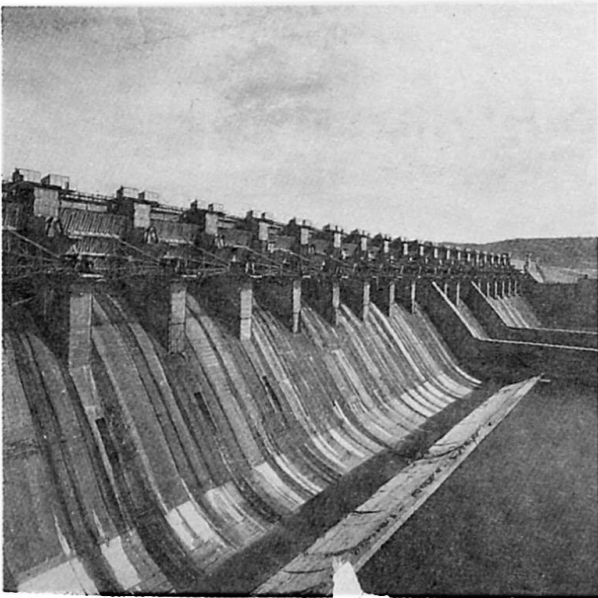

Fig.26 Kadana Dam, Gujarat \*

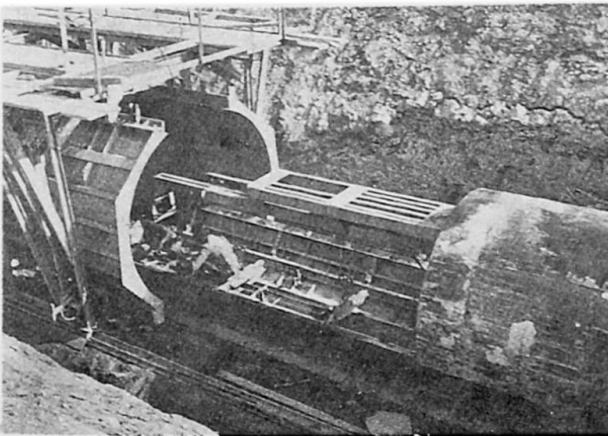
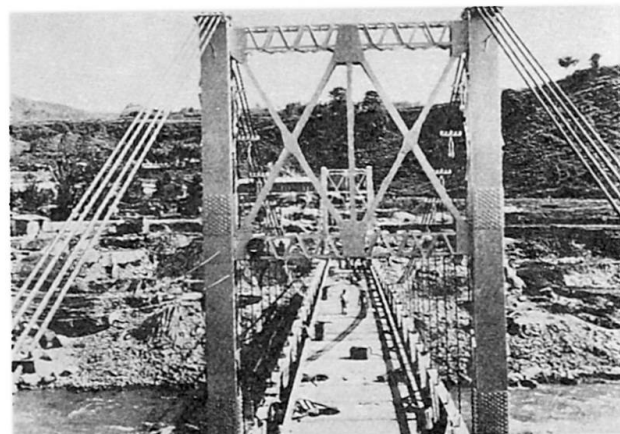

Fig.27 Shutait sewer project, Iraq

Fig.28 Devighat suspension bridge,  
Nepal

\* Designed by Gujarat Irrigation Department

Here I must also point out that the local constraints in other developing countries can vary immensely. If we look at West Asia, there are few financial constraints but most materials, labour and engineers have to be imported. In South-east Asia labour is plentiful and there are few import restrictions, but they lack an indigenous tradition of major construction. Hence, the optimal solutions for these regions will differ. We have been working in many of these regions and have found that an integrated approach can lead to truly innovative and appropriate solutions in a wide variety of fields. A few representative projects are shown in Figs. 27-33.



Fig.29 Bridge on Oran-Benisaf line,  
Algeria

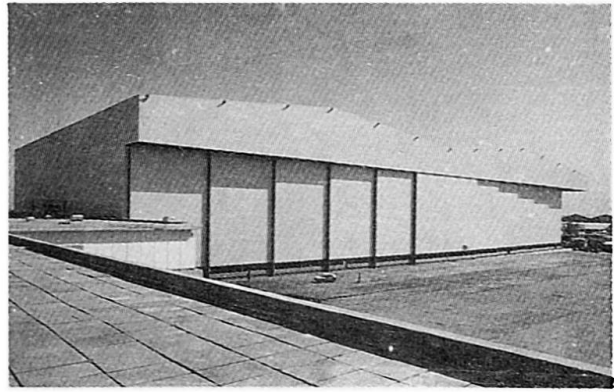

Fig.30 Twin Boeing 747 hangar, Kuwait

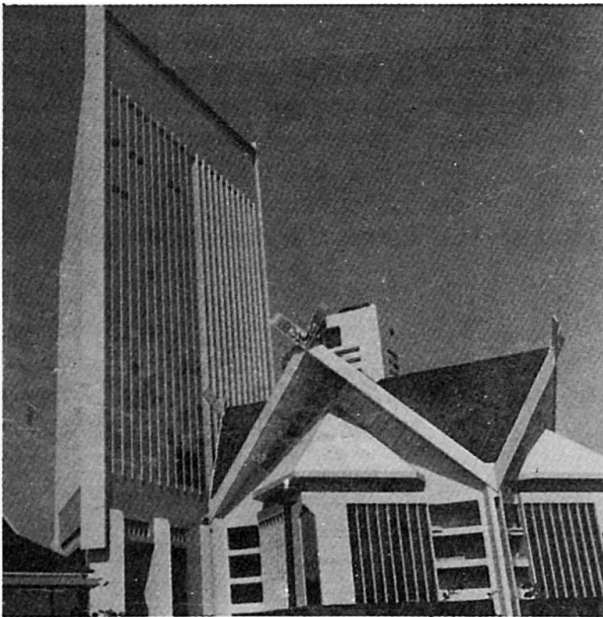

Fig.31 Shah Alam Civic Centre,  
Malaysia

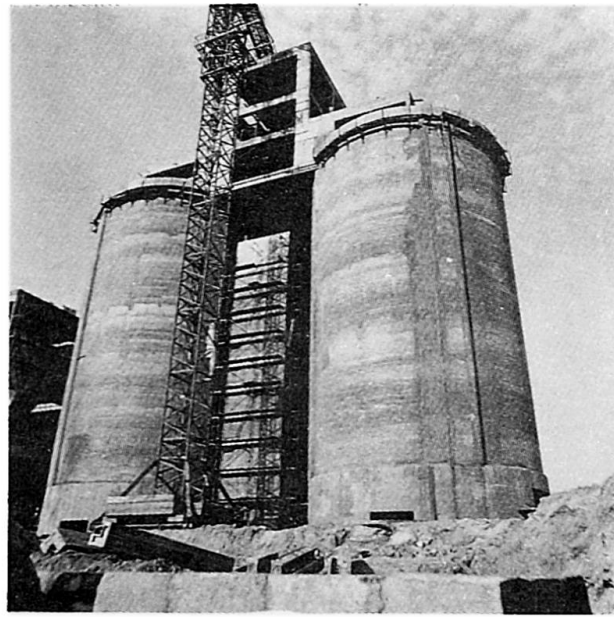

Fig.32 Shuaiba cement silos, Kuwait



Fig.33 Haza Al Maqam reservoir, U.A.E.

The variety of demands on engineers in developing countries is clearly evident. They not only have to operate in more difficult conditions, but have to keep in mind local skills and resources and yet find appropriate innovative solutions. In the process of solving the immediate construction needs, they also have the responsibility to build an indigenous tradition of excellence in construction in the country.