

A. The structural design process

Objektyp: **Group**

Zeitschrift: **IABSE congress report = Rapport du congrès AIPC = IVBH
Kongressbericht**

Band (Jahr): **12 (1984)**

PDF erstellt am: **19.09.2024**

Nutzungsbedingungen

Die ETH-Bibliothek ist Anbieterin der digitalisierten Zeitschriften. Sie besitzt keine Urheberrechte an den Inhalten der Zeitschriften. Die Rechte liegen in der Regel bei den Herausgebern.

Die auf der Plattform e-periodica veröffentlichten Dokumente stehen für nicht-kommerzielle Zwecke in Lehre und Forschung sowie für die private Nutzung frei zur Verfügung. Einzelne Dateien oder Ausdrucke aus diesem Angebot können zusammen mit diesen Nutzungsbedingungen und den korrekten Herkunftsbezeichnungen weitergegeben werden.

Das Veröffentlichen von Bildern in Print- und Online-Publikationen ist nur mit vorheriger Genehmigung der Rechteinhaber erlaubt. Die systematische Speicherung von Teilen des elektronischen Angebots auf anderen Servern bedarf ebenfalls des schriftlichen Einverständnisses der Rechteinhaber.

Haftungsausschluss

Alle Angaben erfolgen ohne Gewähr für Vollständigkeit oder Richtigkeit. Es wird keine Haftung übernommen für Schäden durch die Verwendung von Informationen aus diesem Online-Angebot oder durch das Fehlen von Informationen. Dies gilt auch für Inhalte Dritter, die über dieses Angebot zugänglich sind.

THEME A

The Structural Design Process

Le processus du projet

Der Entwurfsprozess

Chairman: B. Thürlimann, Switzerland
Coordinator: H.R. Schalcher, Switzerland
General Reporter: J.G. McGregor, Canada

Leere Seite
Blank page
Page vide

Design of Offshore Structures, with Emphasis on the Canadian Challenge

Projet de structures offshore, spécialement au Canada

Entwurf von Offshore-Konstruktionen für die kanadischen Verhältnisse

Ben GERWICK
Prof. of Civil Eng.
University of California
Berkeley, CA, USA

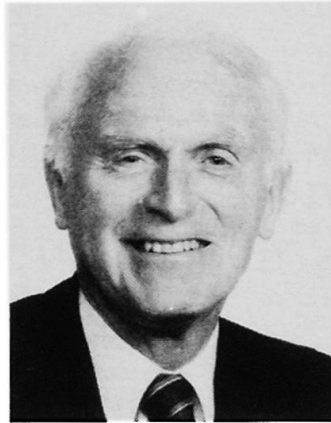

Ben Gerwick, born 1919, was president of Ben C. Gerwick, Inc. and Executive Vice President of Santa Fe Pomeroy Inc., engaged in worldwide marine and offshore construction. He is now teaching Construction Engineering and management and Ocean and Arctic Engineering, and serves as a consultant on Arctic and Offshore Structures.

SUMMARY

The new challenge in the design of offshore structures lies in the Arctic and sub-Arctic regions where environmental criteria include sea ice and icebergs. These considerations dominate the design of offshore oil and gas platforms for the Canadian offshore, and are applicable to other Arctic and Sub-Arctic regions of the world as well. While existing rules and recommended practices for design are generally adequate for the design of offshore structures in temperate zones, there are a number of new or intensified considerations for these regions where icebergs or multi-year sea ice floes may develop much greater lateral forces against structures than hitherto faced in the temperate zones.

RESUME

Le nouveau défi dans le projet de structures offshore provient des régions arctiques avec ses calottes de glaces et ses icebergs. Ce défi se rencontre particulièrement au Canada. De nouvelles sollicitations sont alors à considérer, en particulier l'énorme poussée horizontale de la glace.

ZUSAMMENFASSUNG

Die neue Herausforderung im Entwurf von Offshore-Bauten liegt in den arktischen und subarktischen Verhältnissen, wo die Umgebungseinflüsse auch Treibeis und Eisberge umfassen. Diese Kriterien dominieren beim Entwurf der Offshore-Plattformen für Oel und Gas im kanadischen Fördergebiet. Während bestehende Bemessungsregeln und Richtlinien im allgemeinen für wärmere Klimazonen ausgelegt sind, muss in Zonen, wo Eisberge und Treibeis vorhanden sind, mit viel grösseren Horizontalkräften gerechnet werden.



1. INTRODUCTION

It is part of the very nature of Offshore Structure Engineering that the successes in overcoming the severe wave environment of the North Sea, and the unprecedented depths in the Gulf of Mexico, have led to new challenges in even more hostile and difficult environments.

Today's new challenges lie in the Arctic and sub-Arctic, and in the deeper offshore regions. Canada is host to two of the most difficult regions in the world: Eastern Canada, with its icebergs, and the Canadian Beaufort Sea with its multi-year ice floes containing embedded pressure ridges, its weak soils, and in one area, high seismicity. Should oil ever be discovered off Canada's West Coast, it will pose another new problem, that of very long period waves.

While the design rules and practices developed for the offshore in general and the North Sea in particular give an excellent basis, many new aspects and requirements have emerged in planning for the development of the rich resources of the Canadian continental shelf.

These new considerations include:

- Global dynamic response to impact of massive ice features.
- Concentrated local loadings from ice.
- Transfer of large lateral forces to the foundation soils.
- Materials for Arctic and Sub-Arctic service.
- The appropriate design philosophy for rare events of great magnitude.

While the development of the Canadian offshore presents an unprecedented challenge to engineers, the present state of knowledge and current level of effort indicate that safe, functional and relatively economical structures can be attained to serve the relentless advance of man's offshore resource development.

2. ENVIRONMENTAL FACTORS

We are now confronted with a major new factor, ice. Eastern Canada, offshore Newfoundland and Labrador, present the rather terrifying phenomena of icebergs, ranging in size up to many millions of tons and moving in summer open water with speeds of 1 knot or greater. The resultant kinetic energy is enormous. Impact with a fixed structure can develop forces twice or more than the 100,000 tons environmental design load which is the maximum yet faced in the North Sea, in that case due to storm waves.

While the structures must thus be designed to resist high global forces and transit them into the foundation soils, they must also consider high local forces, as the ice impacts a specific region of the structure. Because of the erratic paths of icebergs under the influence of current and winds, especially in the southern regions off Newfoundland, impact can occur from any direction.

Such local forces, with intensities of 1000 Tons/m² and more, can be imparted not only by large bergs but also by smaller masses, such as "growlers" of a few thousand tons, hurled at speeds up to 8m/s by storm waves.

The ice conditions of the Canadian Arctic are different but no less formidable. The permanent polar pack of sea ice slowly rotating clockwise around the pole, occasionally spins off gigantic multi-year ice floes, with masses comparable to those of icebergs. These floes contain embedded multi-year ridges reaching down as deep as 50 meters. Their kinetic energy of impact must also be absorbed by the structure. Floes up to several thousand meters in diameter may be driven against the structure by the relentless forces of the Arctic ice sheet, limited only by the crushing of the ice against the full rear face of the floe.



In the Canadian Beaufort and especially off the mouth of the Mackenzie River, the soils are extremely weak and unstable. Hence soil-structure interaction tends to dominate the design concepts.

A much rarer but nevertheless critical phenomenon is that of ice islands and ice island fragments. These are tabular icebergs, spawned from glaciers on Ellesmere Island, just west of Greenland, which are caught up in the Polar Pack. Unlike the icebergs off Newfoundland, driven only by wind, current and Coriolis force, these ice island fragments are driven by the polar pack itself.

As if the combination of ice forces and weak unstable soils were not enough, the eastern Beaufort Sea is a zone of high seismicity (zone 3). One must consider the effects of earthquake on a structure whose upper portion is embedded in an ice sheet or ice rubble pile.

Reference has been made above to the difficult Arctic seafloor soils. In many areas the upper stratum is largely silt, varying from unconsolidated silty clay having undrained shear strengths at the surface of only 5 KPa, to overconsolidated silts of high capacity, but frequently underlain by weak strata below.

The surface of the Arctic seafloor is being continuously plowed by the keels of ice ridges, with the resultant 1 to 7 meter deep furrows being refilled with loose silty deposits. While these do not represent an extreme problem for structures, they do for any pipelines leading from the offshore structures towards shore or to a shipping terminal.

At varying depths below the surface (10 to 20 meters usually), subsea permafrost may be encountered. Its upper boundary is thawing over geologic time, releasing water and gas which then may be trapped below the silty clay. This phenomenon may account for the extremely low strengths of such interbedded strata.

Fortunately, off the East Coast, where the icebergs occur, most of the area appears to have very competent seafloor soils, principally dense sands.

The eastern and western coasts of Canada are also exposed to extreme storms. In fact, a number of studies have shown that for specific cases off Newfoundland, the design storm wave may generate larger forces than the design iceberg impact. Of course, this is in large part due to the need to make a bottom-founded structure very massive in order to resist the icebergs: this in turn attracts very large wave inertial forces.

3. DESIGN ASPECTS

A number of authorities have published rules and recommended procedures for the design of offshore structures in the temperate environments, covering the design of both steel and concrete structures. Most widely used are:

API-RP2A "Recommended Practice for the Design and Construction of Offshore Fixed Platforms: (primarily addressed to steel structures)", American Petroleum Institute, 13th edition, 1981.

DNV Rules for the Design, Construction and Inspection of Fixed Offshore Structures, 1977 (revised 1981) and Appendices. Det Norske Veritas.

ACI 357-78R (currently being revised), Design and Construction of Concrete Sea Structures. American Concrete Institute.

FIP Recommended Practice for Concrete Sea Structures, 1978 (currently under revision) Fédération Internationale de la Précontrainte.

While these adequately address the basic principles of design for offshore structures to waves, currents, and earthquakes, additional guidelines are needed for design to resist ice loads.



The American Petroleum Institute has therefore published a tentative set of guidelines as API Bulletin 2N, "Guidelines for Design and Construction of Fixed Offshore Structures in Ice-Covered Waters."

Under the leadership of the Canadian Standards Association, a set of rules for offshore platforms in the Canadian offshore environment is currently being prepared. These presumably will include design for ice loads.

The FIP Commission on Concrete Sea Structures is currently preparing a set of guidelines for the Arctic environment. ACI Committee 357 is also preparing a State-of-the-Art Report on Concrete Structures for the Arctic.

A number of special problems arise due to ice loading. Some of the principal ones will be addressed in more detail below.

4. GLOBAL DYNAMIC RESPONSE TO IMPACT OF MASSIVE ICE FEATURES

As noted earlier, structures may be subject to the impact of very large multi-year floes in the Beaufort Sea or icebergs off the East Coast. Moving at speeds in the range of 0.5 m/s, the kinetic energies are extremely high. Upon impact with a fixed structure, this energy is primarily dissipated by crushing of the ice and ride-up on the structure, thus changing part of the kinetic energy to potential energy. Smaller amounts of energy may be absorbed by friction of the ice against the structure, by local bending and shear, and by the hydro-dynamic forces generated in the water trapped between the impacting bodies, and by the non-linear strain in the foundation soils. Once lodged against the structure, the force is limited only by the continued crushing of the ice sheet against the rear or trailing edge of the floe, and the wind shear on the floe itself.

The crushing along the contact area with the structure is not uniform but rather develops sharp cyclic peaks (ratcheting) due to the iterative breaking of ice fragments as the floe is pushed against the structure. Thus both dynamic amplification and fatigue need to be considered, especially in slender structures. The breaking of ice occurs in discrete elements, in which the force builds up to a peak about twice the average, then falls as the cracks propagate. A force-time graph will thus show periodic peaks, the time interval being dependent on the strength and velocity of the ice and on the natural period of the structure.

In shallower waters, less than 100 meters, various configurations have been developed in an attempt to minimize the ice forces: monopods, cones, and stepped pyramids.

The aim of the monopods is to reduce the contact area. However, when large embedded ridges impact or are forced against such a monopod's column, developing high apparent crushing strengths due to confinement of the contact zone by the surrounding ice, the maxima forces developed are not fully reduced in linear proportion to waterline diameter.

Conical structures are designed to intercept the ice feature below water and force it to ride up. Ice sheets will break in flexure, but thick multi-year floes will just raise up, dissipating their kinetic energy in friction and gain in potential energy. To be effective the cone must have a relatively flat angle: thus it results in extremely large base diameters in deeper water. A full conical shape thus becomes impracticable in water depths over 60 to 80 meters.

A third configuration is the stepped pyramid, designed like the cone to intercept the ice feature at a deeper elevation, and by virtue of the relatively small contact zone, to fail the ice in horizontal shear, plus crushing, at loads well below the maximum allowable. Fig. 1.

In all cases, the greater the distance of penetration, ride up, and displacement, the lower will be the maximum force.



The ice feature may contact the structure centrically or eccentrically, and on a course parallel to a radius or obliquely. This produces a combined lateral shear plus torque, tending to rotate the structure.

The cone and the stepped pyramid both develop their initial reaction at a lower elevation and thus reduce the overturning moment. Overturning moments applied to large base structures normally cause high bearing under the far edge. With cones or stepped pyramids however, the resultant may pass near the centroid of the base, thus limiting the maxima soil bearing values imposed by the impingement of the largest features.

Resistance to lateral shear and excessive bearing may require that the base of the structure be very large, 150 to 180 m. in diameter in typical cases, in order to not exceed the allowable values in the generally weak soils.

A structure of this size will be constructed in temperate waters, outfitted, and towed to the site during the open water season. Naval architectural aspects, towing horsepower requirements, and minimum draft to permit construction and deployment must all be considered in selecting the optimum configuration for a specific location in order to reduce global ice forces and responses to acceptable levels.

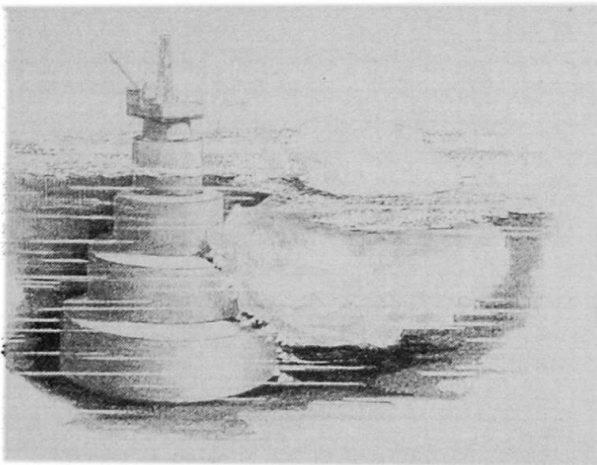

Figure 1 - Stepped Pyramid Concept.

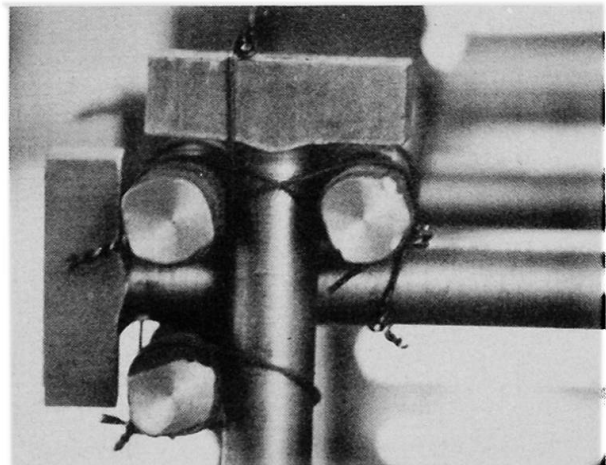

Figure 2 - T-Headed Bars for Shear and Confinement.

5. CONCENTRATED LOCAL LOADS

A moving ice feature will make initial contact with the structure on a discrete area. As the structure penetrates the ice, the contact area progressively increases. The unit pressure over the initial small contact area may be quite high, due to the triaxial confinement of the ice contact area by the surrounding ice giving an indentation factor as much as 3 to be applied to the uniaxial unconfined compressive strength. Small areas, perhaps 2m x 4m in size, may see pressures as great as 14 N/mm².

These high local loads tend to punch through the shell or slab of the peripheral ice wall. Actually, the response phenomenon is often one of combined flexure and shear.

For steel external walls, experience with icebreakers shows that the hull plate tends to deform, transferring the load to the scantlings and thence to the frames. Since there is little load distribution in the typical framing design, these internal members are subjected to high compression and shear, tending to fail in web or flange buckling modes.



Special systems of steel framing have been proposed, utilizing offset inclined frames to absorb the energy of extreme concentrated loads in local plastic deformations, so as to distribute the load to adjoining members. [1]

Concrete shell walls, on the other hand, do distribute the concentrated load well, but are subject to initial cracking in flexure, opposite the load, with moments subsequently redistributed to the supports. Eventual failure comes either in punching shear or in concrete compression. Appropriate reinforcement therefore be provided on all three axes, in order to prevent shear failure and to confine the compression zones so as to ensure a ductile mode of failure. [2]

Both tests and analyses show the important role played by the supports in their resistance to rotation and displacement.

Rational designs for peripheral ice walls indicate the need for a high reinforcement ratio, typically 1-1/2% to 2% on all three axes. This can be met for the two axes in the plane of the wall by bundled bars of large diameters, augmented by post-tensioning in the vertical plane. Splices of such bars may be by lapped or mechanical splices. Lapped splices should be 50 to 100% greater than those provided in the ACI code for static loads, and should be tied at both ends of the lap.

Mechanical splices should develop the full strength in compression and tension.

The difficult axis is that through the wall, which is needed to provide confinement of the compression zone of concrete, restrain buckling of compressive reinforcement, and resist through-wall tension due to shear. Conventional stirrups are very difficult to place through the congested longitudinal and vertical steel. Their size is limited by bend radii requirements. Two or more stirrups of 10 or 12mm. dia. can be bundled and tied together, then placed as a single unit. Nevertheless, it is almost impossible to anchor both tails inside the confined core. Tests show that even well-anchored stirrups fail to develop full yield strength under high transverse tension, due to crushing under the bends and pop-out of the tails.

Mechanically-headed bars have been used in heavy industrial buildings but would be impracticable to place in the typical ice-wall. Therefore, a T-headed stirrup has been developed which can be inserted through the previously placed circumferential bars, then turned 90 degrees to lock its heads behind those bars.

Tests show that such bars develop their full yield strength in tension. By restraining the in-plane bars from buckling and confining the core of the concrete, the compressive ductility is enhanced substantially.

These bars can be forged or can be flame-cut from plate, giving an economical use of steel comparable to that of a stirrup with tails. They permit steel percentages of 1-1/2% or more to be practicably installed through the wall. Fig. 2.

A structural concept of high potential for the peripheral ice wall is that of the hybrid or sandwich-design, in which a steel shell is filled with concrete. The inside and outside steel plates must be tied together, either with transverse plates or by overlapping welded studs. A similar hybrid concept was used by Dome Petroleum for the ice wall of the SSDC-1, an exploratory drilling vessel now operating in the Beaufort Sea.

Local concentrated loads spread over one or two bays of the peripheral ice wall generate very large total forces which must be transferred into the structure through its internal framing to the base slab and thence into the foundation. The role of the internal structural members supporting the peripheral ice wall has often been underestimated. Very high compression and shear will occur in those diaphragm walls or frames behind the load.

Horizontal diaphragms or decks are extremely useful in spreading this load, as is truss action of the vertical walls behind the ice wall.

The ice wall and its immediate supporting structure will inherently be thick, rigid, and strong. Many 2-D and 3-D finite element analyses of different framing systems all show a tendency for the local loads to run around the circumference. Because of relative stiffnesses, comparatively little load is transmitted to internal radial and "egg-crate" bulkheads. Since the vertical walls and frames usually constitute the largest proportion of the total concrete, here is an obvious opportunity to achieve economies by purposefully using a combination of truss action and horizontal plates to spread the load around the circumference, and thence downward through the side walls in membrane shear.

6. TRANSFER OF LATERAL FORCES TO THE FOUNDATION SOILS

In granular soils, such as the sands off Eastern Canada, the shear transfer to the soil may usually be attained by friction alone, under the high dead weight of the ballasted structure. However, full contact under the base or at least under the full annular ring around the outside edge of the base is essential. In the North Sea production platforms, this is accomplished by the use of skirts and underbase grout.

The total ice force must be transferred into the foundation. Sliding is a dominant mode of failure, usually controlling the design in water depths up to 40 to 50 meters. In deeper water, the ice loads, if they impact near the waterline, produce high overturning moments which in turn cause excessive bearing stresses and may lead to tilting. Hence the cone and stepped-pyramid configurations are designed to lower the point of contact, so that the resultant will run as nearly through the centroid of the base as possible.

In the Canadian Beaufort Sea, where the soils are weak and variable, additional shear transfer mechanisms are required. Skirts can be used: however, in shallow water, there may not be enough weight available by ballasting the structure to penetrate the skirts fully into the overconsolidated silts.

Another method proposed is the use of multiple large-diameter steel spuds, installed after founding by a combination of jacking, jetting, and driving. [3] These spuds would not be fixed vertically to the structure, hence would allow it to exert full contact on the soil as settlement occurs. Fig. 3, 4.

Finally, piles may be considered. Similar to typical offshore piles, they will need to carry both axial and lateral loads into the soil. They must be fixed to the structure: this requires a relatively long sleeve for grout bond transfer.

Geotechnical studies must consider cyclic strain phenomena, the non-linear strains in the soil under extreme loads, and settlement over time, especially when production of hot oil may cause thawing subsidence of the permafrost.

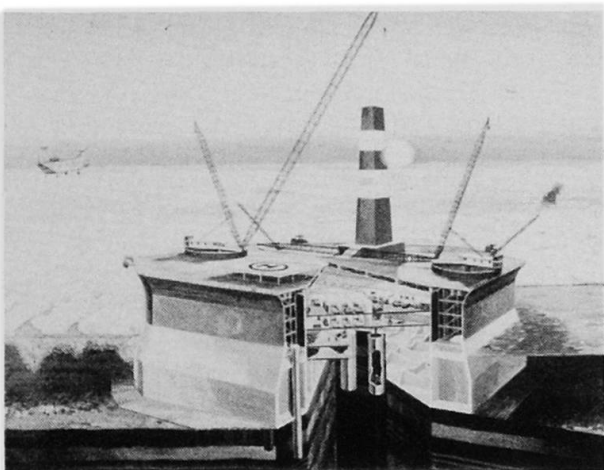

Figure 3 - Sohio Arctic Mobile Drilling Structure (SAMS).

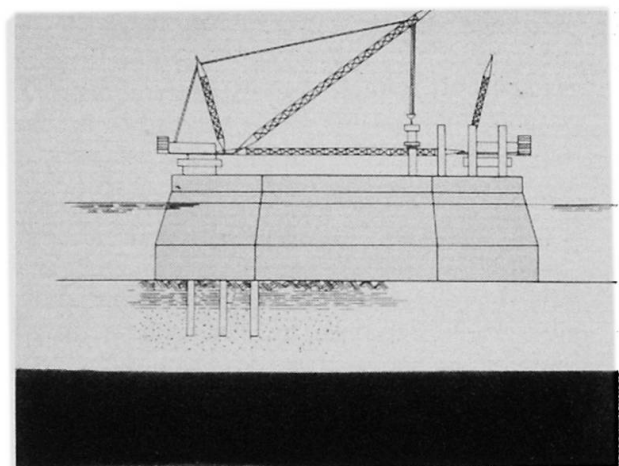

Figure 4 - Use of Steel Spuds to Transfer Shear to Soil.



7. MATERIALS FOR ARCTIC AND SUB-ARCTIC SERVICE

Special concerns about materials for these Arctic offshore projects center around freeze-thaw resistance of concrete that is periodically subject to sea water immersion and splash, the effect of low temperature on behavior under impact, corrosion of steel surfaces where abraded by ice, abrasion of concrete surfaces, use of structural lightweight aggregates and post-elastic ductility.

Extensive laboratory testing plus limited field experience have shown that highly durable concrete can be attained provided an entrained air content of 6% is provided, the aggregates are low in moisture content, and the mix is highly impermeable. The entrained air should consist of voids of proper pore size and distribution: a typical requirement is that the spacing factor not exceed 0.25mm. in the hardened concrete. Air content of the fresh concrete (e.g., 6%) is not an adequate requirement by itself because the current test procedures may include entrapped air, i.e., a few bubbles of large size, which are detrimental rather than helpful.



Figure 5 - Global Marine Super CIDS.

The aggregates should have a low moisture content (4 to 8% maximum) so as to prevent their own disruption by deep freezing. Several of the better lightweight aggregates produced in Europe, Japan, and the U.S. meet this criterion.

The concrete should be highly impermeable. This applies not only to the paste and the aggregate but also to the aggregate-matrix interface. It has been shown that it is the micro-cracking here that produces the majority of the permeability in concrete. Concrete produced with lightweight coarse aggregate may achieve a secondary pozzolanic chemical bound between cement and aggregate particles. The use of pozzolans or condensed silica fumes appears to help in achieving this secondary crystallization, thus blocking the micro-cracks. [4]

High strength lightweight concrete has been developed specifically for use on Arctic offshore structures. This new concrete was used for the Super CIDS (Fig 5) platform, recently built in Japan, for use in the Alaskan Beaufort Sea. Tests shown that when well-confined by reinforcement, this lightweight concrete has high ductility and energy absorption capabilities in the post-elastic range.

At the low temperatures typical of the eastern seaboard and Arctic, conventional steels become brittle under impact loads. Steel which may be exposed to impact should be especially selected to give adequate Charpy impact values at the lowest temperatures expected. Note that steel permanently below water will not be subjected to temperatures below -2 degrees C. These requirements can be met with special alloy steels. New low carbon low alloy steels are now available, which combine high strength with high fracture toughness and ductility.

Welding materials and procedures must also be selected so as to preserve ductility.

Reinforcing steel embedded in concrete appears to behave satisfactorily under low temperatures because impacts are dampened by the concrete. However, it should be selected for ductile performance and the carbon equivalent should be limited.

Prestressing steels such as cold drawn wire are very suitable for low temperature services, retaining their ductility and fatigue endurance. Similarly, concrete itself becomes stronger, both in compression and tension, due to freezing of the pore water.

Corrosion processes proceed slowly in the Arctic due to the low temperature. However, where ice abrades the steel surface, removing corrosion products and exposing fresh surfaces, corrosion may be accelerated and reach 0.3mm/year or more.

Within concrete, the corrosion of embedded steels is similar to that in other environments, although slowed by the low temperature. In general, the use of the highly impermeable concrete mixes referred to earlier will also inhibit corrosion by delaying chloride penetration and limiting oxygen supply to the cathodic areas of the reinforcing steel. Epoxy-coated reinforcing should be considered for concrete decks and for the outer steel layers in the peripheral ice wall.

Concrete surfaces may be abraded by moving ice. Abrasion effects are aggravated by surface freeze-thaw attack. The addition of condensed silica fumes to the mix appears to substantially increase abrasion resistance, partly because it imparts higher strength to the matrix and partly because of better bond with the aggregate.

Thermal strains in concrete can produce cracks. Most of these occur during construction, due to the thick walls and hence high heat of hydration. Upon cooling, the restraint induces tension.

Insulation of the forms reduces the gradient through the walls, and allows the concrete to gain strength before being subjected to tensile strains. Adequate face reinforcing must be provided in both directions, so as to ensure that if a crack occurs, the steel area will be such as to keep the steel stress below yield: then the crack will close as the thermal regime equalizes.

Cracks which do not close are subject to freeze-thaw "jacking", leading to progressive widening of the crack and spalling of the outer edges.

Internal voids and re-entrant angles should be avoided to prevent damage from freezing. Large cells can be protected by styrofoam or even wood blocks in the corners.

8. DESIGN PHILOSOPHY FOR RARE EVENTS

In the design for waves, a rational case can be made for the use of the "100-year return, most probable highest wave" in semi-probabilistic design. The same is not necessarily true for earthquakes nor for sea ice/iceberg events. It is also not adequate for accidental events.

Under extraordinary loads such as accidental loads or exceptional environmental loads such as extreme earthquake or extreme ice impact having a return period of the order of 10^{-4} years, a specific analysis of progressive collapse is necessary. This analysis starts with the identification of the threats to the structure and its possible failure modes, described in hazard scenarios which state the triggering event, such as iceberg impact, and the probable accompanying loads. For each such hazard scenario, the structure is then analyzed using load and material factors of 1.0.

Local failure is permitted provided that the damage is not disproportional to the cause, and provided progressive failure is prevented. Energy absorption and ductile behavior are required. A ductility factor of 2 is believed appropriate.



After such an event, the remaining structure should be able to survive in normal conditions. It should also be possible to effect repairs to restore the structure to use.

The above has been paraphrased from a interim report of the FIP Commission on Concrete Sea Structures and is believed by this author to present a sound philosophical basis for design of structures for the Arctic offshore areas.

9. CONCLUSION

The design of offshore structures has undergone major development over the past decade. The Arctic offshore areas present new challenges, especially those of icebergs and sea ice. The current state-of-art and level of development appear adequate, but barely so, to meet the foreseeable rate of demand. Under the limited environmental data currently available, designs necessarily have to proceed on what is believed to be a conservative basis. Some limited field observations indicate the impact forces developed by given size ice features are substantially less than currently being employed in design. On the other hand, we do not as yet have a full statistical basis of ice events (sizes, velocities, etc.), although this is rapidly being obtained in regions of immediate interest.

This paper has concentrated on structural design considerations involved in the extension of offshore structures of steel and concrete to the Arctic. However, it must be noted that there are other important aspects which the designer must consider as well:

Functional - ability to carry on operations in the severe environment.

Constructability - can it be completed within the available work "window" and under the conditions that pertain?

Ecological - can it be deployed and constructed within acceptable limits of interference with the biosphere, including the indigenous peoples of the Arctic?

Economical - can the work be done within justified limits of total cost?

The North Sea brought about a quantum jump in offshore development in the decade just past. The Arctic and sub-Arctic regions are motivating another quantum advance in man's effort to develop the resources of the seas. This area presents one of the greatest current challenges to our profession, and at the same time an opportunity for sound application of advanced engineering capabilities.

REFERENCES

1. BOAZ, IRWIN, BHULA, D., "A Steel Production Structure for the Alaskan Beaufort Sea", OTC 4113, Offshore Technology Conference Preprints, 1981.
2. GERWICK, B.C., JR., LITTON, P., REIMER, R., "Resistance of Concrete Walls to High Concentrated Loads"; OTC 4111, Offshore Technology Conference Preprints, 1981.
3. GERWICK, B.C., JR., POTTER, R., MATLOCK, H., MAST, R., BEA, R., "Application of Multiple Spuds (Dowels) to Development of sliding Resistance for Gravity-Base Platforms", OTC 4553, Offshore Technology Conference Preprints,
4. GERWICK, B.C., JR., MEHTA, P.K., "Cracking-Corrosion Interaction in Concrete Exposed to Marine Environment", American Concrete Institute, Vol. 4, No. 10, October 1982, Pgs. 45-51.



Problem Identification and Planning

Identification de problèmes et planification

Problem Identifikation und Planung

Richard WEIDLE

Chairman
Weidleplan Consulting GmbH
Stuttgart, Fed. Rep. of Germany

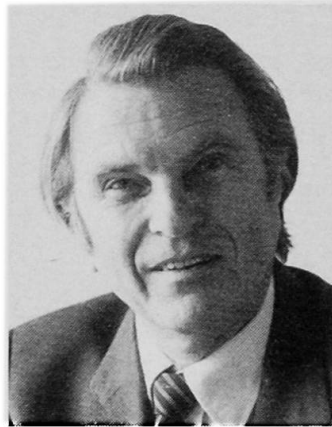

Richard Weidle, born 1922, got his civil engineering degree at the University of Stuttgart, Federal Republic of Germany. In 1948 he founded his own engineering office, later Weidleplan Consulting GmbH, a multidisciplinary consulting company working in more than 20 Middle East and African countries. Mr. Weidle is Chairman of the Board of Directors.

SUMMARY

Problem identification is a planning step in which the task set for the following planning and design work is defined. This can basically take place in any design phase of a project. At the beginning of the project, however, is when problem identification takes on its greatest significance. Problem identification and its methodical integration into the planning and design is dealt with in 5 steps, which are presented in this contribution.

RESUME

L'identification des problèmes est une phase de la planification dans laquelle les futures tâches sont définies. Ceci peut se faire généralement lors de chaque phase d'un projet. Il est évident qu'au début d'un projet, l'identification de problèmes est le sujet le plus important. L'identification de problèmes et l'intégration systématique dans la planification se fait en 5 étapes, lesquelles sont décrites dans l'article.

ZUSAMMENFASSUNG

Problem Identifikation ist ein Planungsschritt, in dem die Aufgabe für nachfolgende Arbeiten erarbeitet wird. Dies kann grundsätzlich in jeder Planungsphase eines Projektes erfolgen. Zu Anfang des Projektes kommt der Problemidentifikation jedoch die grösste Bedeutung zu. Problem Identifikation und deren methodische Integration in die Planung erfolgt in 5 Schritten, welche im Bericht erläutert werden.



In his Introductory Report on the main topic, Prof. MacGregor described problem identification and planning as a study of

- what is needed
- why it is needed
- the objectives and criteria to be used
- the resources available

This speech goes on from there and defines problem identification in general as a design stage, in which the task is determined for the following design stages. The more clearly a problem is identified and the task set for the designer, the sooner and easier an appropriate solution presents itself.

The significance of this design stage cannot be over-estimated. It often happens that it is decided at the problem identification stage already whether the project will be successful or not.

Problems which have not been recognized in the early stage of a project later lead to difficulties and hence either

- to unfavourable compromises
- to the acceptance of an inferior solution and lower quality
- to higher costs
- to going back and starting afresh with design work, which represents loss of time and money

or even to damages in construction at a later stage.

The entire design process can be considered to be a series of solutions to problems, each solution being more detailed than its predecessor. In this respect, problem identification plays a role in every stage of the planning and design, with the number of alternative solutions decreasing greatly according to the progress of the design process. The graph in Figure 1 shows that very many influencing possibilities are to be found at the beginning of the design process, and practically every type of freedom in planning is open.

Figure 1: Degree of Freedom in relation to Planning Progress

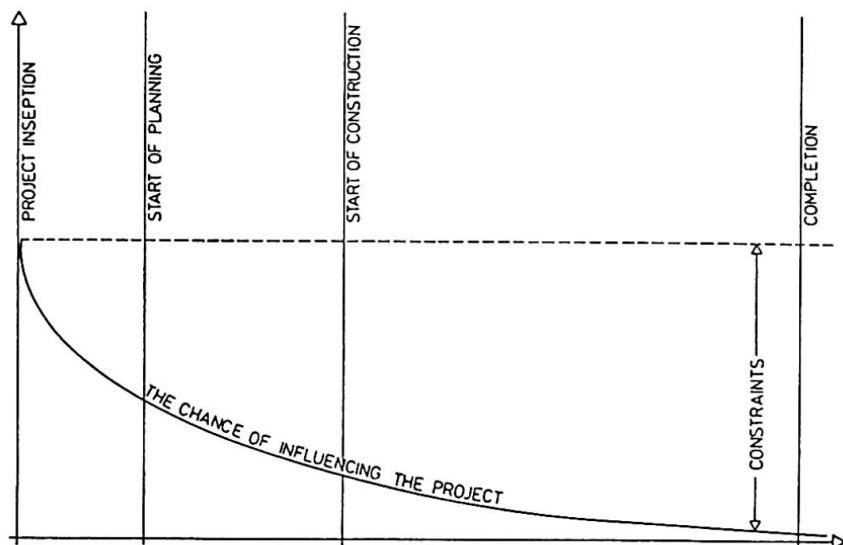

With increasing progress made on the design process and on the decision involved therewith, the degree of freedom and the possible solutions diminish relatively rapidly, so that at the end of the design process, which in many cases already overlaps with the construction execution, the possibilities of influencing the project is only very slight. Or, to put it another way: the constraints caused by previous planning decisions are so great as to leave little in the way of latitude for alternative solutions. This curve in particular, with which everybody is sure to be acquainted, should be recalled time and time again, because it is a clear pointer to the significance of problem identification at the beginning of a design process.

Generally there are two methods of proceeding to expose the core of a problem: the empirical approach of the great master on the one hand and proceeding with method on the other. These two methods are not mutually exclusive and at all events call for a high degree of knowledge and skill. The following is a brief introduction to the general structure of decision ability, taking up one of Prof. Hallasc's thoughts.

Figure 2: Intensity/Band-Width of Knowledge to reach Decision Level

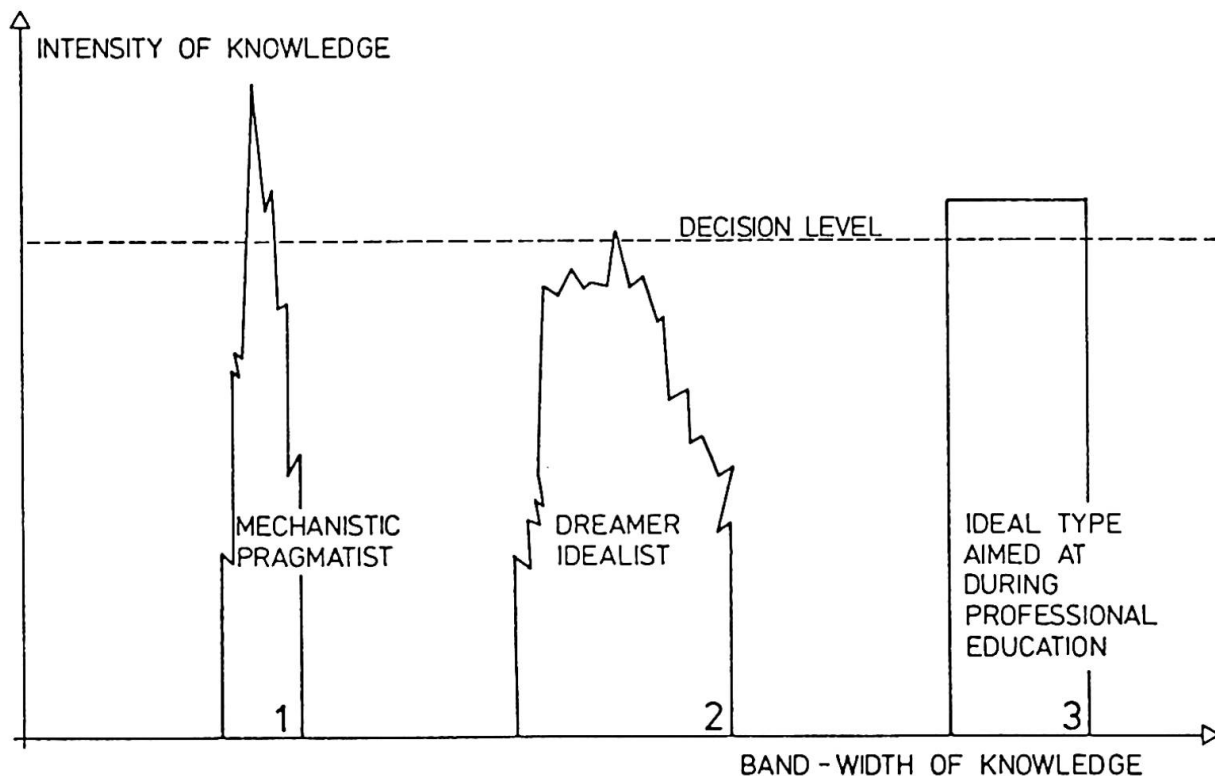



Figure 2 shows a diagram in which the vertical axis represents the depth or intensity of knowledge and the horizontal axis the band-width or amount of knowledge. The dotted line above represents the decision level. This shows that a great degree of knowledge is needed to be able to reach and cross the decision level, thus enabling a decision to be taken.

Sketch 1 depicts the actual position of scientists and engineers, with the depth or intensity of the knowledge diminishing towards the top. However, a very considerable area of knowledge breaks through the decision level and in part even oversteps it considerably. Sketch 2 shows the type of the more emotional being or "dreamer", who has a wide horizon of knowledge. Out of this group nearly nobody reaches the decision level, only the great masters. Sketch 3 shows the ideal type who reaches beyond the decision level with the whole extent of his knowledge. University education ought to aim at this type and also create the appropriate conditions.

Design stages in which the exact problem is not yet known need to an even greater extent a broader established decision ability. This also results in the necessity of having step-by-step methodic procedure. An aid for mechanical engineers is the directive from the Association of German Engineers with the title "Construction methods - conceiving technical products"

This step-by-step methodic procedure may be split into the following five steps:

1st Step: Basic Information

The project contract often does not contain the information required for determining the task. This information has to be procured. In doing so, the following questions should be looked into:

- what is the core of the task?
- which wishes and expectations exist?
- do the conditions laid down in the scope of task apply?
- which paths are open for development?

The planning objectives must be determined. When so doing, the following questions are useful:

- what purpose must the actual solution serve, what features must it have?
- what features must it not have?

The following are recommended for collecting information:

- finding out of fixed data and focal points
- checking the state-of-the-art
- judgement of future developments

After all the information has been collected, work can begin on elaborating the requirements.

2nd Step: List of Requirements

For later assessment of solution variants and to facilitate decisions, differentiation must be made between requirements and wishes. Requirements or at least minimum requirements can be quantitative data or descriptive data, such as

- utilization requirements based on demand investigations (e.g. loads, areas, etc.)
- surrounding conditions such as foundation, soil, climate, earthquake, wind, material available
- safety - covering fire protection, fire escape routes, attacks, symptoms of material fatigue
- costs: here the total costs should be considered, i.e. investment costs including later operating and maintenance costs
- construction and planning time

Wishes should be considered where possible, under certain circumstances accepting a limited amount of extra effort and expenditure.

Wishes could be:

- demands on convenience, including air-conditioning, comfortableness, variability of utilization, protection against environmental influences and emission
- Aesthetic demands such as the call for something special, the integration of the structure into the landscape, characteristic design for a particular project.

Wherever possible, the demands will be compiled in a requirement list or project description.

Figure 3: Finding of Solution by Problem Structuring

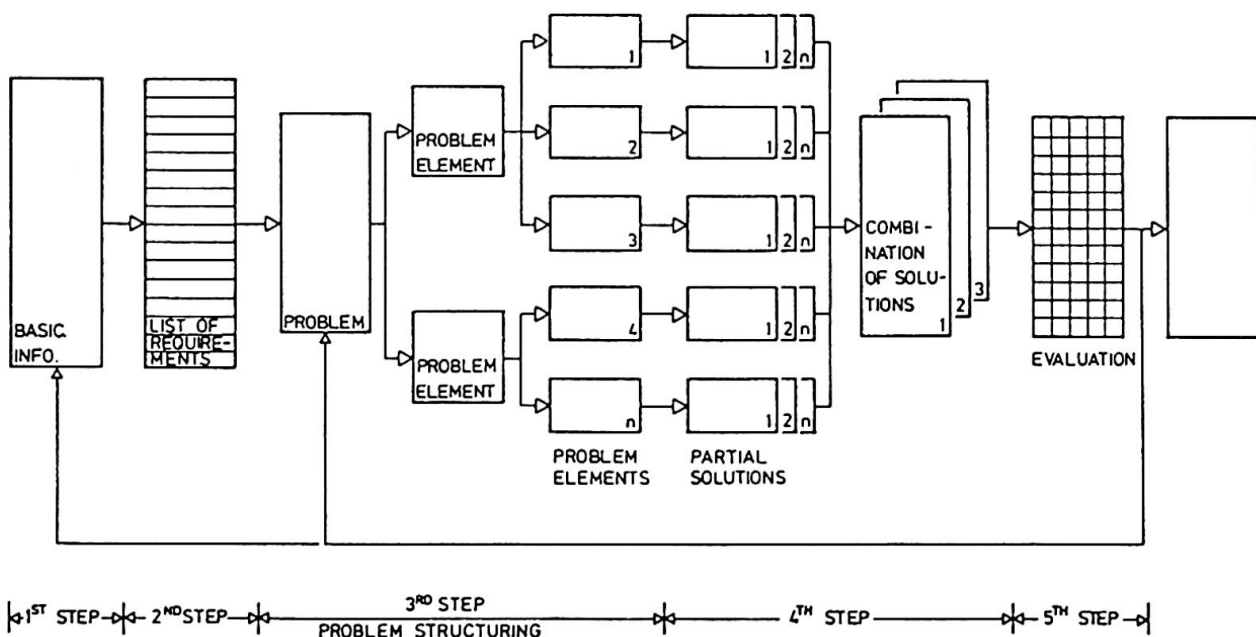



3rd Step: Problem Structuring, Division of the overall Problem into Problem Elements

The step which now follows seems to be one of the most important: the structuring of the problems. Problem structuring can be defined as the transformation of a vague formulation of task into a solvable problem description.

In doing so, the problem elements, which occur in part by listing the individual requirements and in part as a result of their superimposition and/or combination, are to be brought into relationship with each other. Hierarchical structures must be developed for each project and must portray the value of the individual problem elements. These would have to be orientated to the overall aim to be reached, to the technologies to be applied and would have to finally reach a form of representation which clearly shows how a solution to the problems is possible.

In this connection it should be especially mentioned that solutions predetermined in the design contract - insofar as they are not imperative - are often a hindrance in finding optimum solutions. As far as the problem structuring and identification are concerned, this means that the problem is formulated along abstract lines and that only the essentials are accentuated. If, for example, the requirements stipulate "prefabricated elements shall be used, to reduce construction time in the problem identification this would be softened to "minimum construction time is to be achieved". General information of this kind leads on the one hand closer to the core of the problem, on the other hand it encourages several alternative solutions.









4th Step: Partial Solutions and Combination of Partial Solutions.

After structuring of the overall problem into well-defined problem elements, which are clearly allocated to each other, solutions to these problem elements can now be worked out.

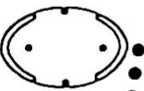
Figure 4: Schematic Morphological Box

PROBLEM ELEMENTS		SOLUTION PRINCIPLES						
		1	2	•	i	k	•	m
1	F_1	P_{11}	P_{12}	•	P_{1i}			
2	F_2	P_{21}	P_{22}	•	•	•	•	P_{2m}
•								
•								
n	F_n	P_{n1}	P_{n2}	•	•	P_{nk}		

Figure 5: Morphological Box for the Design of a Multipurpose Hall

MORPHOLOGICAL BOX FOR A MULTIPURPOSE HALL					
PROBLEM ELEMENTS	PARTIAL SOLUTIONS. / SOLUTION PRINCIPALS				
PLAN OF BUILDING					
STRUCTURE	LOAD BEARING	ONE-DIMENS.	TWO-DIMENS.	THREE-DIMENS.	MEMBRANE
	TYPE OF STRUCTURE	COLUMN BEAM	FRAMES, ARCHES	SHELLS	TENTS, HANGING ROOFS
MAIN CONSTRUCTION MATERIAL	R.C. / P.C.	STEEL	COMPOSITE	TEXTILES	SYNTHETICS
FORM, APPEARANCE CONTOUR, FUNCTIONAL ARRANGEMENT					
DEGREE OF INNOVATION, IMPRESSION OF BUILDING	MODERATE	REMARKABLE	OUTSTANDING	LANDMARK	

◆ VARIANT 1 ▼ VARIANT 2 ● VARIANT 3

The morphological box has proved its worth in the systematic finding of ideas and as a representation, providing a clear overview. The morphological box, in the form of a two-dimensional array, is shown in Fig. 4. In the case of the morphological box, one proceeds on the assumption that each whole problem can be broken down into problem elements, which, in turn, when combined together, form potential overall solutions. The box can in fact be applied in order to find solutions for the respective whole problems to any system, consisting of whole problems and n problem elements.

In the 1st column the n problem elements are entered, designated $F_1 - F_n$, as far as partial, corresponding to the sequence of their taking effect. The possible solutions associated with each problem element are listed in the appropriate lines. Any arbitrary combination of partial solutions will lead to a possible solution; the number of results shall be denoted "Z".

Theoretically, the maximum number of solutions is the product of the number of partial solutions in the first to n -th line. Hence, for a complete matrix, maximum Z will be m^n .

Formerly, one aimed at the highest possible value of Z and it was recommended, like in a chess play, to check in one's mind all connection lines seeming to make sense and to select those, which seem the most promising. This, however, involves a lot of effort and is basically also not necessary, insofar as a specialist is the one selecting the possible solution.



During this process, the specialist can fulfil the basic demands from the out-set, namely:

- a) Disregarding theoretically possible solutions which are obviously not feasible
- b) Avoiding the linking of partial solutions which are incompatible with each other

It is advisable to put a) first and not to start on evaluating the morphological box until afterwards, which leads to the span of solutions being greatly diminished.

Even then, however, only those solutions which fulfil the basic requirements of b) are of any use as solutions to the overall problems. Figure 5 shows an example of a simplified morphological box for the design of a multipurpose hall. The various alternatives are shown and how the partial solutions can be combined.

5th Step: Evaluation of Concept Variants

One arrives at concept variants by combining partial solutions. These variants now need to be evaluated. The requirements and wishes compiled in the list of requirements present themselves as evaluation criteria or objectives.

In practice, depending on the type of task set, the evaluation and decision in favour of a variant in the form of a discussion or as a formalized evaluation procedure has proved its worth. It is important to keep minutes of the decision taken in a discussion in order to be able to re-examine the decisions made, should the parameters change in the future.

It is not likely, that any one potential solution will represent an ideal match to all requirements and objectives. So the advantages and disadvantages of one solution have to be traded off against each other to separate the most desirable variant. Very sophisticated techniques of decision-making have been developed in recent years. A very simple, yet powerful method is to award points to each evaluation criteria according to their technical and economic merit. In doing so, a so-called "use value matrix" is set up as tabular compilation of the evaluation. According to their importance, the awarded points for each criteria are multiplied by a weighing factor. The totals of weighed points for each variant can now be compared with one another. It must be noted, that the number of points, as well as the weighing, may be correlated or non-linear and are heavily dependent on the judging individual. Figure 6 may serve as an example for such an evaluation table.

Even during this phase alternatives are often sought for weaknesses discovered in the conception which present themselves in the course of the evaluation.

Figure 6: Evaluation Table for Concept Variants

FIG.6 EVALUATION TABLE

EVALUATION CRITERIA		Weighing Factor	Variant 1		Variant 2		Variant 3	
			Points	Weigh. Points	Points	Weigh. Points	Points	Weigh. Points
FORM 20%	Uniqueness	10	2	20	4	40	10	100
	Integration into Environment	10	5	50	4	40	6	60
FUNCTION 20%	Variability of Utilization	6	10	60	5	30	6	36
	Sight Line	8	7	56	6	48	4	32
	Natural Lighting	3	6	18	2	6	5	15
	Acoustics	3	6	18	5	15	4	12
SAFETY 10%	Fire Resistance	7	4	28	2	14	5	35
	Resistance against Environm. Impact	3	6	18	4	12	6	18
COSTS 30%	Building Costs in resp. to Lifetime	15	8	120	2	30	5	75
	Maintenance Costs	10	5	50	2	20	6	60
	Utility Costs	5	7	35	3	15	7	35
CONSTRUCT. TIME 5%		5	6	30	8	40	4	20
OTHERS 15%		15	4	60	5	75	4	60
100%				563		385		558

The result of the evaluation is a solution of the problem initially identified on the one hand, and the point from which to proceed with the following design stage on the other.

The methodical steps towards problem identification and towards working out solutions to the problems which have been shown here are basically applicable in each design phase. In accordance with Figure 1, however, the problem span is narrowed down further as planning and design process, and the tasks set become increasingly more specific. Whereas one is at the beginning still deciding on the overall conception of a building, later on, concepts, such as fire-fighting, facade elements or site mobilization need to be developed.

The requirements become increasingly easier to qualify and the problem itself easy to identify, for example, "selection of corrosion protection" or "design of a bearing". One would then no longer take the trouble to set up a morphological box, but would rather only develop design alternatives and variants and then evaluate these (See Figure 6 as an example).

Experience has shown, that in the course of the short periods available for the planning and design work and in the initial feeling of euphoria when starting on a new project, one is in danger of committing oneself over-hastily to one design solution. Not until continuing work on the project which is in progress, does one hit on points which cast serious doubts on the design. Such errors can be avoided if one incorporates problem identification quite consciously as a design stage - a design stage which can approach very systematically and integrate into the later design phases.

**REFERENCES:**

ASSOCIATION OF GERMAN ENGINEERS, Construction methods - conceiving technical products. VDI Richtlinie No. 2222, Part 1: Design Engineering Methodics; Conceptioning of individual products. May 1977. Part 2: Design Engineering Methodics; Setting up and use of design catalogues. February 1982.

Choice of Structural Concepts

Choix de concepts structuraux

Wahl des strukturellen Konzepts

A.C. LIEBENBERG

Partner
Liebenberg & Stander
Cape Town, South Africa

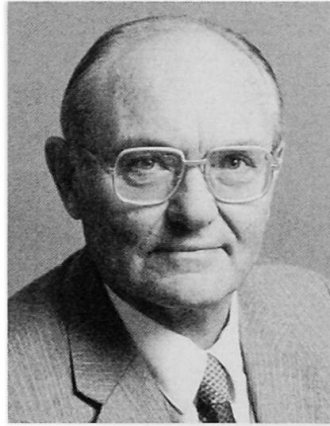

Charles Liebenberg, born 1926, graduated at the University of Cape Town where he did postgraduate research. Dr Liebenberg has been responsible for the design of major bridge and building structures and has produced numerous publications on the theory and practice of Structural Engineering. He serves on various professional councils.

SUMMARY

This paper describes the nature of the processes of conception and selection as important parts of structural design to achieve prescribed objectives in compliance with modern design criteria and practice. Various factors and constraints that influence decision-making are enumerated and the scope and limits of significant innovative progress indicated. The application of optimisation procedures is discussed, as well as the importance of relating simplified deterministic methods to a statistical probabilistic philosophy.

RESUME

Cette contribution décrit la nature des processus de conception et de sélection en tant que parties importantes dans le projet des structures pour atteindre les objectifs fixés en concordance avec les critères modernes de conception. Différents facteurs et contraintes qui influencent toute décision sont énumérés et l'étendue et les limites du progrès innovateur sont précisés. L'application des procédures d'optimisation est discutée de même que l'importance des méthodes déterministes simplifiées par rapport à une philosophie probabilistique.

ZUSAMMENFASSUNG

Dieser Artikel beschreibt die Art des Prozesses der Entwicklung und Auswahl von wichtigen Teilen des strukturellen Entwurfs, um vorgeschriebene Ziele zu erreichen, in Übereinstimmung mit modernen Entwurfskriterien und der Praxis. Verschiedene Faktoren und Beschränkungen, die Entscheidungen beeinflussen, sind aufgelistet, und der Umfang und die Begrenzung von bedeutenden neuen Entwicklungen wird aufgezeigt. Die Anwendung von Optimierungsmethoden wird diskutiert sowie auch die Wichtigkeit des Bezuges von vereinfachten deterministischen Methoden zur statistischen Wahrscheinlichkeitsphilosophie.



1. INTRODUCTION

The choice of structural concepts is the most challenging and crucial part of the design process. It consists of the conception and selection of structural form and configuration, the determination of the shapes and dimensions of the component members and the arrangement of the fabric or assembly of all the parts to comply with the objectives and overall plan. It provides the structural designer with an opportunity either as principal agent in the case of engineering structures, or as consultant to architects on building projects, to participate in creative design.

After having established his brief and identified the problems, he is faced with the task of finding conceptual solutions which have to be reduced to optimal states by what is generally known as the standard design method. This method in the form commonly used, is based on a deterministic decision model, Fig. 1, which consists of discrete steps commencing with information research and problem identification to clarify the brief. Thereafter the design parameters have to be determined and all necessary assumptions formulated. Conceptual design then proceeds, followed by analysis, checking, evaluation, comparison and selection. This process incorporates feedback with a series of repetitive cycles, or looping, involving the whole or parts of the process, also seeking new information and alternative ideas to converge in a spiralling fashion on a solution to satisfy design criteria and to optimize the product. Creative or innovative ideas are essential to the conceptual stage, but considerable ingenuity and subjective judgement may also be needed to achieve progress at other stages of the process.

The last two decades have seen the development of statistical methods of design which have advanced rapidly from the classical probabilistic theories, to modern reliability theory. The principles of risk theory and reliability analysis related more directly to safety, have been well documented and further research is an ongoing activity. On the basis of this work, first level limit state codes of practice for design, although deterministic in application, nevertheless take account of uncertainty and risk by various partial safety factors, thus providing improved consistency. However, gross errors, mainly of a conceptual nature or due to lack of recognition of problems or negligence, remain the major sources of concern so that adequate checking procedures covering all classes of error remain essential. There has been much debate on this problem[1]. Recent developments[2] in the theoretical treatment of human error may become significant in the application of higher levels of design, but the complexity of the problem is so great that at present there is no satisfactory formalized procedure for eliminating gross errors. It is basically a human problem and the capabilities of the members of a design team are consequently critically important. The shortage of competent engineers exacerbates the situation.

Design criteria can be categorised under functional purpose and requirements, practicability, reliability, durability, cost, aesthetic quality and environmental impact. Under functional purpose and requirements would be indicated the manner of use of building or engineering structures, the nature of the actions to which they might be subjected and the constraints imposed by regulations. Practicability is the essence of engineering which implies the effective transformation of ideas into reality. The importance of relating conceptual design to the site conditions and the envisaged construction methods, is critically important for purposes of practicability and economic construction. The achievement of reliability is the reduction of risk to acceptable levels which in practice is usually prescribed in codes of practice. However, compliance with codes does not necessarily cover all forms of risk. Durability can be expressed in terms of the inverse of the expected costs of maintenance. Cost should be evaluated in relation to total utility as defined later, but in practice is usually reduced to those values that can be expressed in real money. This may not necessarily give the most beneficial results.

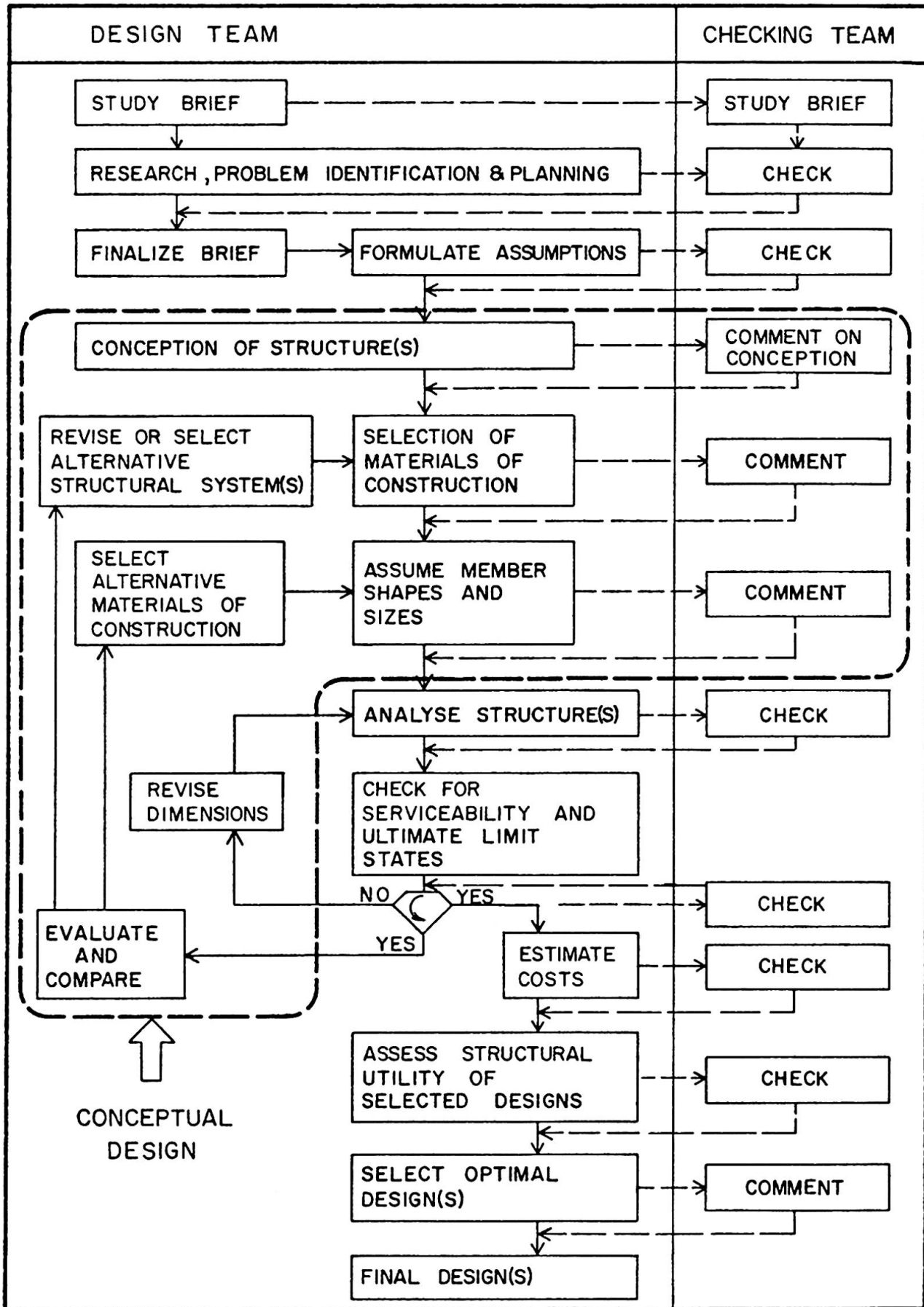

fig. 1 Simplified flow chart for limit state structural design



Aesthetics[3], being a subject belonging to philosophy and the arts, differs essentially from the disciplines that constitute modern engineering. It follows that an understanding of aesthetics and its importance does not always come naturally to the engineers of today. Generally they develop a predominantly logical approach to design without the intuitive sensibility and judgement that is essential for the appreciation and meaningful evaluation of the aesthetic aspects of their work. Engineers have consequently over the years applied whatever innate abilities they may have had in aesthetic appreciation, with greatly varying degrees of success. There have, however, always been gifted exceptions with a good understanding of the subject and the profession as a whole has during the last decade or two, shown a renewed interest therein.

Various excellent papers and articles have appeared[4] that define the basic principles of aesthetics in structural engineering. Some of the authors attempt to relate these to working rules. It is not the intention to decry the work of those that have in the past and recently produced such design rules, as there is no doubt that they serve a useful purpose, especially for the novice. It must be remembered, however, that these rules or laws have been deduced from past results and do not necessarily have a fundamental basis. They only work to the extent that they define some visual properties of structures which are aesthetically satisfactory and have withstood the tests of time, not unlike classical art. Every design can best be considered to be unique and even where such rules are applied, an imaginative adjustment will invariably result in some improvement. Most artists and architects today appear to agree that there are no rules by which one can create or measure the quality of art or architecture. According to Herbert Read[5] in discussing the meaning of art: 'Many theories have been invented to explain the workings of the mind in such a situation, but most of them err, in my opinion, by overlooking the instantaneity of the event. I do not believe that a person of real sensibility ever stands before a picture and, after a long period of analysis, pronounces himself pleased.'

Since the 1960's, people have become more aware of the need to preserve what is referred to as the 'quality of life', a term which is not easily defined, but amongst other things relates to the attainment of certain social and aesthetic standards and freedoms for mankind, while preserving as much of the beauty of the natural environment and its resources as is feasible and keeping it free of pollution. Likewise, engineers have come to recognise the importance and value of these considerations that extend beyond those more directly related to engineering technology. Unfortunately, many of these considerations cannot be quantified accurately because of their subjective nature. Various procedures have, however, been developed for doing so-called 'impact studies' to assess the effects of a project on the environment and the inhabitants of the affected area. Various authorities require Impact Statements which are usually considered by interdisciplinary committees prior to approval of the project. Environmental impact studies and evaluations should be carried out during the early stages of the site investigation, but subsequent feedback studies may be necessary during the conceptual design of the structure.

Optimization can in theory be best achieved by maximizing total utility expressed in terms of an objective function defined operationally with probabilities and evaluated in monetary terms. The terms of the function should include criteria such as the expected present value of the overall benefits derived from the existence of the structure, initial costs, capitalized normal maintenance costs and expectation of damages. The evaluation of utility can be extended by the inclusion of subjective criteria such as aesthetic quality and environmental impact which require evaluation by judgement. It is not possible in practice to accurately quantify the terms of the abovementioned objective function, but even an approximate evaluation along these lines can serve useful purposes in identifying inconsistencies. Developments of Decision Theory, Operational Research and Mathematical Programming, are paving the way to a better understanding of methods and procedures to realize these objectives.



Design decisions relating to the general form and details of the structure, are greatly influenced by the nature of the loads and actions to which it is subjected, by materials and methods of construction envisaged and by environmental conditions. At a recent IABSE symposium held in London[6], the factors that affect the selection of structural form were extensively discussed. These included the influences of natural and other forces such as dead weight, wind, earthquakes, snow loads, hydraulic forces, man-made loads and materials of construction. Also discussed were the influences of thermal and other environmental conditions, as well as the technical, economic and cultural factors in different design situations.

In spite of the fundamental nature of the improvements in modern structural engineering philosophy, the immediate and visible economic advantages of many of the refinements in design and analysis that are being developed at present, are marginal. This has resulted in considerable resistance to accepting the new ideas from some practising engineers, largely because of the increased complexity. This may also be due to a natural resistance to change, which presumably can be overcome in time. However, even the simplified first level codes of practice have not been readily accepted in all circles, hence the attempts at further simplification. Although there are obvious advantages therein, the dangers inherent in this process require careful consideration. It is important that structural engineers should have a sound understanding of the principles underlying these modern developments in design. Even if simplifications of practical codes are necessary, the qualitative aspects of the probabilistic philosophy and their influence on design decisions should determine the attitude and approach of the individual engineer in his choice of structural concepts. This may have a significant effect on the reliability of the structure.

2. THE CONCEPTUAL PROCESS

The conceptual design of engineering structures requires that the designer have a combination of mental attributes consisting at least of the ability to innovate by deductive and intuitive adaptation of existing concepts. In more imaginative cases, the conception of original ideas comes about by creative thinking. Although the nature of the mental processes of creative thinking or invention have largely been taken for granted and are even today not clearly understood, interest therein is not exactly a new development[7]. Initially it had mainly been the philosophers that had struggled with the problem. Some of the reasons for attention to the creative process were however, practical, as insight into the nature thereof can increase the efficiency of almost any developed and active intelligence. Although logical thinking had since Aristotle been exalted as the one effective way in which to use the mind, this conclusion had been questioned for some time. Leibnitz (1646-1716) had expounded the concept of unconscious ideation. The notion of somewhat different mental processes that are not necessarily deductive or intuitive and that involve an unconscious element in the inventive process, had already become well known in philosophical and literary circles in the early 19th century. However, it does seem that mathematicians have spoken of it in the clearest way, probably because in mathematics invention as a process is more easily recognisable.

When at the beginning of the century Henri Poincaré gave his celebrated lecture[7] at the request of a number of Parisian psychologists to explain what in his personal experience invention was, he knew nothing of the findings of modern brain researchers. What he said was that the solution of a problem does not necessarily come about at the conclusion of a lucid and conscious effort, but that on the contrary - especially for the really difficult problems which led him to propose entirely new formulas, creative formulas one might say - the solution had surged forth when he least expected it, at times when he was doing something quite different. The role of what he then called the unconscious, is even more remarkable since, as he said, he was led to address himself without



knowing why to a certain element of the problem, or to a difficulty which seemed to be without any relationship to the general problem with which he was struggling, as if for relaxation. Then, after days or weeks, he realized that what he had thought was a contingent phenomenon was in fact precisely an element of the process of discovery which was to lead to the final solution.

The importance of the work of the unconscious in mathematical invention was thus clearly realized by Poincaré. On the topic of inspiration versus drudgery as the source of mathematical discovery, he concluded[8] that mathematical discoveries, small or great, are never born of spontaneous generation. They always presuppose a soil seeded with preliminary knowledge and well prepared by labour, both conscious and subconscious. A similar remark is attributed to Edison to the effect that genius is 99 per cent perspiration and only one per cent inspiration. However, Gauss had a hundred years before said[9]: 'I know that I discover things, but I don't know how I discover them, and when I reflect on it, I think that it can only be a gift from God, since things come to me all of a sudden without my having done anything, apparently, to merit them.' More recently, Professor Joseph Weizenbaum discussing the work of psychologist Jerome Bruner, concludes[10] that we learn from the testimony of hundreds of creative people, as well as from our introspection, that the human creative act always involves the conscious interpretation of messages coming from the unconscious.

Henri Poincaré had also said about creative thinking[9] that: 'The important thing, if you want to find the correct idea, is to begin by thinking off-centre (penser à côté).' More recently Edward de Bono has developed the concept of lateral thinking[11] as an inductive method to develop new ideas and as a problem-solving technique that extends beyond logic. It employs a mix of random and logical procedures involving a certain amount of repetition, a certain amount of imprecision, all of which are inseparable from the process of bringing about a new idea. The complementary 'vertical' logic, which is suitable for deriving or extending rules or algorithms is, however, essential for testing the validity of creative ideas in specific areas of engineering such as those related to the physical and functional aspects that influence structural reliability and effectiveness.

A comprehensive logical system in itself militates against innovation as rules negate the above-mentioned 'random freedom'. History is one long stream of examples that demonstrate this fact as Paul Feyerabend has ably shown in his book titled 'Against Method'[12]. He argues that the most successful scientific inquiries have never proceeded according to the rational method at all. He examines in detail the arguments which Galileo used to defend the Copernican revolution in physics, and shows that his success depended not on rational argument, but on a mixture of subterfuge, rhetoric and propaganda. Feyerabend argues that intellectual progress can only be achieved by stressing the creativity and wishes of the scientist rather than the method and authority of science. Earlier other philosophers like Popper[13] and Thomas Kuhn[14] had produced different arguments in which they demonstrate the limitations of the scientific method. Major advances in science, e.g. Newton's laws and theory of gravity, denied the logic within the accepted paradigm of that time and required ad hoc concepts like force acting at a distance which defied all explanation. Modern science is no different and Max Jammer[15] gives an enlightening account of the conceptual development of quantum mechanics which reminds one in many ways of the discovery of the double helical structure of DNA by James D Watson and Francis Crick, so humorously described by the former in his delightful book 'The Double Helix'[16].

In all these scientific works the importance of lateral thinking is predominant. Innovation in technology is a similar process. Established scientists were still proclaiming the impossibility of sustained flight by heavier-than-air craft when the Wright Brothers made their epoch-making flight at Kitty Hawk in 1903. Goddard experienced a similar resistance to his pre-war research in rocket flight and Whittle to his efforts to develop a jetfighter plane.



The underlying mental process in the innovative design of engineering and building structures is not unlike that in the other fields of creative effort referred to above. It presupposes certain basic levels of knowledge and experience which are essential for the ability to apply the conscious and intuitive procedures and a will to solve the problem, for the subconscious mental processes to culminate in ideas. P R Whitfield[17] has stated that as a mental activity, the moment of creation appears to be largely outside our conscious control, although it is more likely to be stimulated when we have become immersed in a subject. A burning desire to find a solution, concentration, gathering and marshalling of facts and striving for completion by reaching out for still vague ideas, are all activities we can feel and largely control at a conscious level. They mobilize and direct energy to finding a solution, but they are really only precursors to the act of creation, which seems to have a quality of spontaneity making it difficult to track and explain. Harding (1967), suggests[17] that the flash of inspiration often associated with scientific and engineering problems, comes when the scientist tries to rest by turning away from his problem. When thinking or doing something else, the solution suddenly comes to him. Whitfield refers to the mysterious incubation phenomenon, which acts at a time of deliberate withdrawal.

In engineering, the expression of creativity is in part internal and personal and in part dependent on the external opportunities and pressures in an individual's environment. Creative, innovative and entrepreneurial aptitudes seem to need many strengths in addition to special talents in a particular field. Joint efforts by several individuals in the form of "brainstorming" sessions have produced very fruitful results.

The adaptation of existing design concepts, configurations and details in design to achieve the objectives and requirements of specific structural projects, constitutes a very large percentage of the work executed in practice and does not necessarily involve substantive innovation. However much it may conflict with the aspirations of the individual designer for a unique and novel solution, the mere reorganisation of a design along the lines of existing works, does not necessarily detract from the merits thereof. It may be preferable in economic terms to imitate or repeat successful designs, than to invent purely for the sake of diversity.

The history of the design of engineering and building structures does, however, indicate that real progress is very largely dependent on innovative design. There are, however, many aspects of the modern design process as practised that inhibit innovation. The underlying logic which forms the very basis thereof is inherently restrictive on innovation. So also is an obligatory code of practice. The codification of procedures has become essential for good order and the standardisation of methods is an objective that can be rationally justified in terms of sound economics, provided alternative procedures based on proven research are allowed.

Koestler (1964) observed that the act of discovery actually has a destructive and a constructive aspect; it must disrupt rigid patterns of mental organisation to achieve the new synthesis. Only by escaping from the popular frames of reference and critically examining conventional methods and techniques can new ideas be developed and implemented. Disorder appears to be a necessary part of the creative sequence and uncertainty goes with it.

Interesting as they are in suggesting how creative activity occurs, these observations offer little help in describing the actual process. We do not know what goes on at the neurone level, how nerve cells make their individual contribution or act together to form new patterns and insights. But there does seem to be a basic organizing and reorganizing activity going on all the time within the mind, which seems to select and arrange and correlate these ideas and images into a pattern. Innovation in engineering is therefore a complex problem-solving sequence which is not fully understood.



Judgement and approval of creative works by the general public is usually based on the 'common wisdom' of knowledgeable groups giving guidance. Engineering works are largely judged by their usefulness, but in structures aesthetics is important.

3. THE LIMITS OF PROGRESS

Although there are apparently limitless possibilities of varying the detail of design conceptions by rearrangement of a particular structural configuration or fabric and changing the type and shape of its members, there do appear to be definite limits to significant progress in a more radical sense. It is almost impossible to give a clear definition of progress in general terms as it can mean many different things to different people depending on circumstances, but in structural engineering it can perhaps be most simply described in terms of the design criteria previously discussed. However, the measure of improvement even for so practical a subject, cannot be absolutely quantified because of the inherent indeterminacy of those criteria.

Much has been written about the nature of progress and of future trends. The dynamics of progress and their importance for the understanding of history, were set forth some sixty-five years ago by Henry Adams in his 'Law of Acceleration'. The acceleration can be explained in terms of reactions involving an element of positive feedback: the further the reaction has already progressed, the faster its further progress. But as Professor Gunther Stent[18] postulates: 'This very aspect of positive feedback of progress responsible for its continuous acceleration, embodies in it an element of temporal self-limitation. For since it seems a priori evident that there does exist some ultimate limit to progress, some bounds to the degree to which man can gain dominion over nature and be economically secure because of our boundaries of time, energy and intellect, it follows that this limit is being approached at an ever-faster rate.' There are many schools of thought on the general implications of this trend, varying from the pessimistic that believe that this limit will be reached soon, to others that optimistically consider such limits merely as thresholds to new developments generated by significant inventions.

In structural engineering there are obvious physical constraints that determine the bounds of the possible at any time. These bounds may be extended with the development of knowledge and new materials, but quite clearly have limits which are related to the physical realities of the earth such as the range of upper limits of the spans of various types of structures as determined by weight and strength of materials of construction. For various forms and configurations of structure, these limits can be calculated using the materials or composites of materials that are available today. Galileo (in about 1600 AD) came to the important conclusion that it was impossible to increase the size of structures to vast dimensions in such a way that their parts would hold together[19]. Super materials may extend these limits, but eventually upper limits will no doubt be reached.

Progress may also be approaching upper limits due to the apparent near exhaustion of ideas within the above-mentioned range of practical configurations. Some of these configurations were already foreshadowed in the earliest primitive constructions. The evolution of structures as a process of sophistication of these configurations, has been largely related to the development and application of materials and methods of construction to meet specific needs.

The rates of progress in the various fields of application in structural engineering, have in the past often been exponential, but usually reducing towards optimal ceilings or thresholds depending on whether or not pertinent ideas are expended, or whether subsequent innovations are of a sufficiently revolutionary nature to initiate new phases of development. New or improved materials and methods, often developing as a result of inventions in other fields, have generated innovation in structural engineering and created eras of



rapid development. This happened during the Industrial Revolution and after the world wars. Various benefits have been derived from by-products of space research programmes.

The state of the art or philosophy of structural engineering has played a major role in determining the rate of progress. In the early days of the development of structures prior to 1800 AD, design methods were largely intuitive, being based on experience (often catastrophic) and very elementary and rudimentary theory. In the early part of the 19th century, very significant advances were made in the theory of mechanics of materials by Navier (1785-1836), but it took several decades before engineers began to understand them satisfactorily and to use them in practical applications. This work heralded a new period in engineering and was probably the beginning of modern structural analysis. Navier was the first to evolve a general method of analysing statically indeterminate problems. His work was followed by major contributions of other famous mathematicians, scientists and engineers whose works have been well documented[19] and form the basis of modern structural engineering.

Today we are in possession of greatly enhanced empirical knowledge, coupled with the advanced methods of modelling and analysis provided by modern structural theory with powerful numerical methods used in conjunction with electronic computers, both for analytical work and computer-aided design. The modern design engineer is thus in a better position to evaluate alternatives and take decisions. His scope has widened considerably. Optimization and decision theories are paving the way to a better understanding of methods and procedures to realize objectives. However, there are limits to what computers can do[10] and judgement will retain a most important role in structural design. This fact must be recognised as such in formal design procedures. Whereas the philosophy of cybernetics has had awe-inspiring success in its application to technological systems and in systems engineering, it is patent that the initial optimism with regard to automata with creative ability cannot be realised[20].

Hopefully we are approaching the end of what can be called the period of deterministic methods and striving to achieve greater rationality by the application of statistical (probabilistic) procedures of analysis and design. This has opened the field with almost unlimited prospects of development in applied theory, even if initially only in the form of first-stage indeterminate theories. The practical benefits relate largely to improved reliability, but the direct economic benefits appear to be comparatively marginal at this stage.

4. CONCEPTION AND SELECTION IN STRUCTURAL ENGINEERING

4.1 General

A study of the historical development of buildings and bridges makes it very evident how various factors have influenced the selection of structural form in the past[16]. The fundamental basis has perhaps always been that of trial and error from primitive huts built of mud, stones, reeds or other natural materials to provide shelter and the use of timber logs or boulders in crude masonry arches and ropes made of creepers or vines in small suspension bridges, to the lofty spires of cathedrals and modern engineering structures.

It is clear that gravity and other forces due to loads and actions have played a major role in shaping structures and determining the configurations. Experience gained in time and lessons learnt from failures, have contributed to the knowledge that we have today. These, in conjunction with the theory of structures that has grown concomitantly with practical experience and experimentation, provide the basis for conception and selection in modern engineering practice. The process has become more sophisticated, but the role of intuition and unconscious ideation, is as important as it was in the time of Leibnitz.



In form and configuration, the vast majority of innovative designs are re-arrangements or adaptations of the fabric of proven designs. Such adaptations are often related to an improved understanding of loads and actions, usually based on theoretical analyses combined with experimentation such as wind forces and earthquakes and the response of structures thereto. Several notable innovations have been apparent such as the improvement of the profiles of bridge decks of suspension bridges to reduce wind effects, methods of damping oscillations in tall buildings, or the elimination of gross movements due to earthquakes by special bearing arrangements and increasing the ductility of shear walls under extreme earthquakes.

The limiting trends referred to above, do not imply that modern structural conceptions cannot be unique, nor that a major invention is not imminent. It only implies that the frequency of such events is reduced in well established fields of structural engineering. I do not believe that structural engineering has reached anywhere near the limits of excellence. In the application of materials and construction methods, there have been a spate of inventions although some of these were foreshadowed in other fields. There is also a definite trend towards improved methods of fabrication and control resulting in better materials and improved structural performance and reliability whereby the designer's scope is increasingly widened. This process is bound to continue in the foreseeable future. The development of standardized designs for economic reasons is not necessarily a limiting process.

Some of the most substantive innovations today are related to the demands for structures in new environments such as the developments in the off-shore industry and sea structures and to a significant increase in scale such as very tall buildings and towers as well as special structures required for scientific and industrial developments.

4.2 Conception

Conceptual thinking is not necessarily confined to a single phase of the design process, but is essential to all the procedures for improvement. However, the initial ideas may be critical in setting objectives. Mentally, the designer should be attuned to a way of identifying the problems and seeking conceptual solutions that approximate roughly to the optimum. This comes from experience and a well-grounded understanding of how structures work; the ability to visualize the distribution of forces in structural members; to be able to assess the influence of the relative stiffnesses of members and the response to static and dynamic actions. The more refined that the designer's insight is, the sooner will the design process converge to effective and optimal solutions and the less likely will the occurrence of gross errors be.

A designer who has an understanding of the statistical properties of materials of construction and of the indeterministic nature of the response of structures to random actions, will invariably be at an advantage to attain greater consistency in the reliability of the final product. This understanding should not only apply to the behaviour of individual structural elements or members, but to the assembly thereof and the interaction among various components and the possible modes of failure. Risk is very much dependent on the combinatorial probabilities of failure of elements. Chain structures, with failure dependent on the weakest link, should if possible be avoided. This is mostly not possible, but then suitable adjustment should be made to safety factors where this is warranted. The converse applies where great redundancy is present. Similar arguments apply to single elements where the consequential damages of failure may be high. Such situations often occur during construction. First level codes of practice do not allow for such discrepancies in risk, but a competent designer will take these effects into account.

Although the conception of new structural form is largely motivated by the need to solve engineering problems, the aesthetic aspirations of the designer are



inseparably involved. The extent to which he succeeds in imparting visual quality to his works, will depend on his sensibility to aesthetic values. The most successful designers of beautiful structural form clearly have a creative urge not unlike that of a sculptor. On structural projects such as bridges where visual form must come primarily from engineers, consultations with suitably experienced architects may nevertheless be beneficial. The modelling of form and configuration in this manner opens almost unlimited opportunities for aesthetic improvement by variation. This should not be confused with mere ornamentation. The various creations of Maillart and many others bear ample evidence of the ability of creative engineers to sculpt structural forms in a pleasing manner by going beyond pure functionalism in the process of solving specific engineering problems, but staying within acceptable economic bounds. Aesthetic design of a structure and its parts should therefore not be done as an afterthought, but should at all stages be part of an integrated process.

Designers tend to develop various optimizing techniques that either minimize internal energy by for example using configurations or forms of structure that generate resistance by extensional forces in preference to bending, or by minimizing the response to actions, for example by designing shapes to reduce wind effects. Some would minimize materials or relate the design very closely to the construction methods. These objectives should not however be singled out.

The recent advances in methods of theoretical modelling and analysis and knowledge of structural mechanics including the post-elastic and post-buckling phases, have opened new avenues of design and analysis which often extend beyond the reach of intuitive insight. Methods like finite element analyses have become extremely powerful tools to achieve accurate simulation of complex structural behaviour. Conceptual design has thus done a full circle and has reverted to a trial and error process of a nature which would have been impossible at the levels of complexity we are referring to without the modern generation of computers. In design practice things generally happen more crudely, but the benefits of the results of the more sophisticated analyses are usually passed on to set new standards. There is a better perception of the statistical nature of actions such as for example the structure of wind and the nature of earthquakes and the response of structures thereto. However, problems in predicting certain trends, such as the modelling of traffic loading on highway bridges which is not a purely random phenomenon but subject to human manipulation, have once again become evident. Authorities and experts in various countries still differ greatly on modelling of highway traffic. The same problems apply to floor loadings in buildings.

4.3 Selection

Selection is a very important part of structural design and consists of a searching for optimal solutions by identification of possibilities, followed by evaluation and comparison, leading to the final choice. Whereas classical optimization procedures have limited application in structural design, numerical methods have opened new approaches. However, judgement still plays an important role in practice. Essentially the decision-making process takes two forms. Firstly there are procedures for finding the best solutions for particular members or configurations of members and which usually consist of the step-wise or incremental adjustment of dimensions or forms in precalculated or random directions to obtain optimal solutions. Classical and numerical procedures can be applied in some of these cases. The other method distinguishes between alternatives that differ discretely or absolutely with respect to the parts or the whole, such as in alternative designs with different configurations or of different materials. The basis of selection should be total utility as defined in chapter 1, even if it can in practice only be partially done by value analysis in terms of monetary costs with a qualitative assessment of other equally important but subjective criteria such as aesthetics and environmental impact.



5. CONCLUSION

Although no part of the design process is unimportant, the choice of structural concepts is crucial. It challenges all those inherent and acquired abilities by which a designer takes decisions that determine the essential quality of an engineering or building structure. Although computerisation is reducing the role of human designers in analysis and in the production of documentation, conceptual design will remain the domain of the engineer and well designed engineering structures will therefore always bear the stamp of individual designers.

REFERENCES

1. VARIOUS AUTHORS: Safety concepts, Theme X, Final Report of the 11th Congress IABSE, Vienna, 1980, pp 1019-1030 and pp 1056-1062.
2. LIND, N C: Models of human error in structural reliability, Structural Safety, Vol 1, No 3, April 1983, Elsevier Science Publishers BV, Amsterdam, pp 167-175.
3. LIEBENBERG, A C: The aesthetic evaluation of bridges, Chapter 36 Bridges, Handbook of structural concrete, ed by F K Kong, R H Evans, E Cohen and F Roll, Pitman Books Ltd, London, 1983, pp 36/36-45.
4. VARIOUS AUTHORS: Aesthetics in structural engineering; Theme 1, Final Report of the 11th Congress IABSE, Vienna, 1980, pp 43-155.
5. READ, H: The meaning of art, Penguin/Faber & Faber, London, 1949, p 29.
6. VARIOUS AUTHORS: The selection of structural form, Symposium Report, IABSE Symposium, London 1981, 257 pp.
7. GHISELIN, BREWSTER, (Ed): The creative process, a symposium, Mentor, New American Library, New York, 1952, pp 11, 33-42.
8. BELL, E T: Men of mathematics, Vol 2, Pelican, Penguin Books, London, 1953, p 604.
9. MORAZÉ, CHARLES: Literary invention, the structuralist controversy, Proc. of a symposium, ed by R Macksey and Eugenio Donato, John Hopkins University Press, London, 3rd printing, 1977, pp 23, 35.
10. WEIZENBAUM, J: Computer power and human reason, W H Freeman & Co, San Francisco, 1976, pp 218, 221.
11. DE BONO, EDWARD: Lateral thinking, Penguin Books Ltd, England, 260 pp.
12. FEYERABEND, PAUL: Against method, Verso, London, 1979, 339 pp.
13. POPPER, KARL: Logic of scientific discovery, 1967, (2nd ed), Hutchinson, London.
14. KUHN, THOMAS: The structure of scientific revolutions, University of Chicago, Chicago, 1962.
15. JAMMER, MAX: The conceptual development of quantum mechanics, McGraw-Hill Book Co, New York, 1966. 399 pp.
16. WATSON, JAMES D: The double helix, Penguin Books Ltd, England, 1970, 175 pp.
17. WHITFIELD, P R: Creativity in industry, Penguin Books Ltd, 1975, 217 pp.
18. STENT, GUNTHER S: Paradoxes of progress, W H Freeman & Co, San Francisco, 1978, 231 pp.
19. TIMOSHENKO, S P: History of strength of materials, McGraw-Hill, New York, 1953, 452 pp.
20. SURVEY OF CYBERNETICS, Ed by J Rose, Illife, London, 1969. p 27.

Structural Design Process with Seismic Considerations

Processus de la conception des structures et considérations sismiques

Der Entwurfsprozess mit seismischen Überlegungen

E.P. POPOV

Prof. Em. of Civil Eng.
Univ. of California
Berkeley, CA, USA



Egor P. Popov is President of the Structural Engineers Association of Northern California and Chairman of the AISC Code Subcommittee on Special Provisions for Seismic Design. He is also a member of the US-Japan Joint Technical Co-operative Committee on simulated seismic experiments. Dr. Popov has done extensive research and has been widely published on seismic behavior of reinforced concrete and steel structures. He has been a structural consultant on a number of major buildings.

SUMMARY

This paper discusses the structural design process with particular reference to the problems encountered in seismically active regions. The basic differences with conventional design are identified and the underlying philosophy for developing seismically resistant structures is presented. An appraisal of analysis methods is given, and some difficulties in adapting elastic solutions for post-elastic behavior are pointed out. Strong emphasis is placed on the need for considering the plastic limit state in all cases. The design process is illustrated by showing an identification of the problem, a choice of concept, and the development of the necessary experimental support for eccentrically braced steel framing.

RESUME

L'article traite du processus de la conception des structures compte tenu des problèmes spéciaux rencontrés dans les régions sismiquement actives. Il précise les différences fondamentales avec la conception conventionnelle et présente la méthodologie du développement des structures résistantes aux séismes. L'article évalue les méthodes de calcul et indique quelques difficultés dans l'adaptation des solutions élastiques au comportement post-élastique. Il met en relief la nécessité de tenir compte de l'état-limite plastique dans tous les cas. Le processus de la conception est illustré par l'identification du problème, le choix d'un concept, et le développement du support expérimental nécessaire pour une ossature métallique à contreventement excentré.

ZUSAMMENFASSUNG

Diese Arbeit diskutiert den Entwurfsprozess unter dem besonderen Aspekt der Probleme bei Bauwerken in Erdbebengebieten. Die Hauptunterschiede zum konventionellen Entwurfsprozess werden herausgestellt. Die Grundgedanken beim Entwurf von Bauwerken, welche Erdbebenlasten widerstehen können, werden vorgestellt. Verschiedene Lösungsmethoden der Baustatik werden bewertet und die Schwierigkeiten aufgezeigt, um mittels linear-elastischer Methoden auf das nichtlineare Verhalten zu schließen. Besonderes Gewicht wird auf eine sorgfältige Untersuchung der plastischen Grenzzustände für alle Lastfälle gelegt. Der Entwurfsprozess wird am Beispiel von exzentrisch ausgesteiften Stahlbauten vorgestellt. Es wird eine Beschreibung der Problematik gegeben. Ferner wird ein Entwurfskonzept aufgezeigt und das Programm der notwendigen experimentellen Untersuchungen beschrieben.



1. INTRODUCTION

In the introductory report for Theme A, Professor MacGregor discusses the nature of structural engineering and succinctly outlines the design process involved in such work. For seismic design the general approach remains the same, but significant differences in emphasis are necessary. These pertain to the need for greater involvement of the structural engineer with the conceptual solution of the structural problem as well as with concern for the ever-present uncertainty of the loading conditions. Unquestioning adherence to codes and elastic methods of analysis may result in unsatisfactory structures, leading to total collapse and huge loss of life during a severe earthquake [4].

In many respects seismic design remains an art and places a great deal of responsibility on the structural engineer. Some of the above general ideas are elaborated upon in the paper by first identifying the problem, discussing the selection of a design, and providing an evaluation of the current approach for seismic analysis and design. The newly developed eccentrically braced steel framing is then used to illustrate the seismic design process.

2. PROBLEM IDENTIFICATION AND CONCEPTUAL SOLUTION

A conceptual solution of a structural problem for resisting lateral forces requires the highest level of structural engineering talent and judgment. By studying the proposed configuration of a structure, noting the distribution of mass and the foundation conditions, a possible lateral supporting system can be conceived.

On major structures an interaction between the architect and the engineer is imperative, the earlier the better. In devising a lateral supporting system, one must think in terms of a systems approach, i.e., floor diaphragms, their attachment to the vertical supporting system, the vertical support system itself, as well as overturning and foundation problems. Anticipation of problems arising from perforation of the floor diaphragms by stair and elevator wells, mechanical equipment, telephone ducts, etc., as well as an appreciation of the capacities of slender vertical walls or braced bays, must form the basis for selecting a structural framing system. Consideration of story drift control at service loads and ample ductility during a maximum credible earthquake for a given site are imperative.

Simultaneously with the process of selecting a structural system, a decision must be made on the materials to be used. For smaller structures, fire code permitting, wooden framing is economical and has an excellent record of performance during severe earthquakes. The use of reinforced concrete or masonry for garage enclosures or of structural steel or prestressed concrete members for larger spans often is a logical solution. On the other end of the spectrum, i.e., for tall buildings, structural steel is generally preferred, although in more recent years composite frames of reinforced concrete and structural steel have been adopted in spectacular applications [5,21]. The use of structural steel often is logical in construction of large factory complexes because of ease of alterations. One- and two-story warehouse and commercial buildings normally are more economically built in reinforced concrete.

For the bulk of non-residential construction in the four- to twenty-story group of buildings, there is strong competition between reinforced concrete and structural steel. At the present time, a significant number of such buildings on the West Coast are being constructed in structural steel. The choice is based primarily on cost considerations, which change rapidly. Therefore, the engineer must have current familiarity with construction costs, although admittedly the choice of a material is often based on personal

preference, either of the engineer or architect.

The more a particular building deviates from the conventional, the more framing schemes must be examined before adopting a solution. The appraisal of a framing system in seismic design has a number of special aspects, which will be considered in the next section.

3. APPRAISAL AND SELECTION OF A DESIGN

In appraising and selecting a design for a highly seismic environment, several aspects of the structural problem must be carefully scrutinized. Some of these assume far greater importance than for a conventional design.

In seismic design there is always considerable uncertainty as to the loading conditions during a major earthquake. On the other hand, for reasons of economy, the safety factors for buildings are kept small. An optimized, efficient structural system for gravity loads may not be the best choice for seismic applications. Redundancy in the structural system is desirable. Concentrating lateral resistance in a few members may not result in the best earthquake-resistant structure. For example, four shear walls, with two at each end of a building, are preferable to just two equally strong end walls. Likewise, concentrating all of the lateral resistance on one bay of a multi-bay steel frame is less desirable than distributing the resistance to several bays. Fortunately, the code-writing groups are beginning to recognize the advantages of redundancy in seismic resistant construction.

Most experiments are made to small scale, and the successful ones become a presumed standard of performance. Such results are freely extrapolated to related cases, and certainly to much larger sizes. One can hardly expect the same performance from field-erected structures, and the size effect has been poorly explored. Moreover, most of the available research is on isolated members and joints. The experiments recently completed at Tsukuba, Japan, on a full-size seven-story reinforced concrete building [18] and on a six-story steel building [6,7] are notable exceptions. But even in these cases, the member sizes are modest in comparison with many modern structures. Extrapolations from the available data to large members encountered in practice should be done with a great deal of caution.

Information learned from damage caused by past earthquakes should be related as much as possible to the design being considered. Full recognition of the differences between modern and earlier construction should be made: the days of heavy concrete fireproofing of steel members and massive partitions are gone. The steel is no longer joined by rivets, which in the past completely avoided the problems of lamellar tearing. Stringent requirements often introduced immediately after a damaging earthquake gradually tend to be relaxed. Monotonic static tests are usually considered fully adequate to demonstrate a point. Experience with the behavior of tall buildings in major earthquakes is very limited. Strong trade partisanship is evident in many cases. Unfortunately, if cost-effective simplifications are accepted a few times, they become state-of-the-art and next to impossible to change. Attachment of wood diaphragms to masonry without anchors or reluctant use of continuity plates in moment-resisting beam-column steel joints may be cited as examples.

Because of the smaller factor of safety used in seismic than in conventional design, the engineer charged with an appraisal and selection of a design should be conversant with the items discussed above.

The extensive technical literature which describes the damage incurred during major earthquakes provides useful information. Some such observations are



synthesized by structural engineers. The Structural Engineers Association of California has standing committees which modify a model seismic design code on a continuous basis [16]. These recommendations gradually find their way into the basic national building codes [19]. Similar comprehensive activity is carried on in the USA by the Applied Technology Council [1], as well as by the broader-based Earthquake Engineering Research Institute [4]. On the international level, the International Association for Earthquake Engineering [3] disseminates basic information in this area, principally through quadrennial world conferences.

4. SEISMIC ANALYSIS AND DESIGN

The lateral forces given in the codes [2,19], which represent the effect of an earthquake on a structure, are a gross simplification of a very complex problem. The random dynamic repeating and reversing forces that develop during a seismic event are reduced to a set of deterministic equivalent static forces for design. Only large or monumental buildings are analyzed dynamically, and such a requirement is written into law only in the Los Angeles code for buildings over 160 ft in height or for those of irregular shape [2]. Elsewhere, the dynamic analyses are performed at best only on major buildings to obtain a better idea of the structural response and also, in some instances, to reduce the code-stipulated lateral forces. If a dynamic analysis of a structure is performed, its behavior under the maximum credible earthquake can be much better understood.

The lateral static forces specified in the codes [2,19] are much smaller than those that would be expected if a building were to respond elastically. However, because some acceptable structural damage in a major earthquake in the form of controlled inelastic or plastic deformations dissipates the input energy, dynamic analyses clearly show that forces acting on a structure are significantly reduced. This is illustrated in Fig. 1, where the behavior of single-degree-of-freedom systems with different natural periods of vibration are exhibited. The base shear coefficient for an elastic system ($\mu_\delta = 1$) for this selected severe earthquake is given by the upper curve; the code values [19] multiplied by 1.4, giving approximately the threshold level at which inelastic action would begin, are given by the dashed line. Only by designing a structure capable of deforming plastically to reach a displacement six times the elastic one, i.e., for the deflection ductility $\mu_\delta = 6$, does one obtain a reconciliation between the code-specified forces and structural response.

Admittedly, the example cited is for an extraordinarily strong earthquake; for smaller quakes, one finds a less critical situation. Further, on the average, the mechanical properties of materials usually exceed their specified values, and, due to the redundancy, the loading pattern usually becomes advantageously redistributed; nevertheless, it is essential to note that in seismic design one must be assured of ductile behavior at overloads. Such behavior cannot be taken for granted.

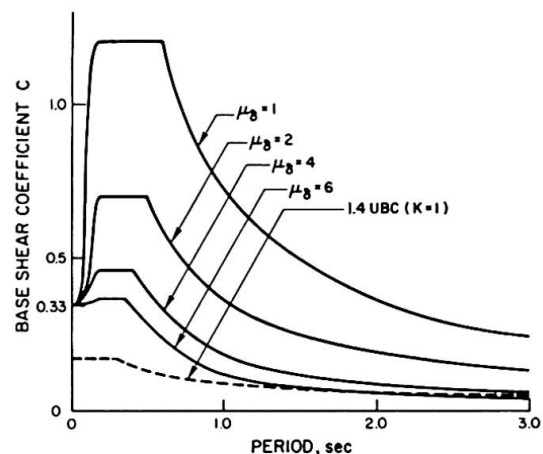

Fig. 1. Base Shear Coefficient Curves [20].

Design engineers are well aware of the basic point made above. However, generally in the US, analyses are made using elastic concepts carried out with the aid of computers. For estimating the ductility demand of various members or connections, either for static or dynamic cases, the approach shown in Fig. 2 is often employed. From such a diagram the ductility demand μ is determined from the relationship:

$$\mu = \frac{M_0}{M_p} = \frac{\theta_0}{\theta_p} \tag{1}$$

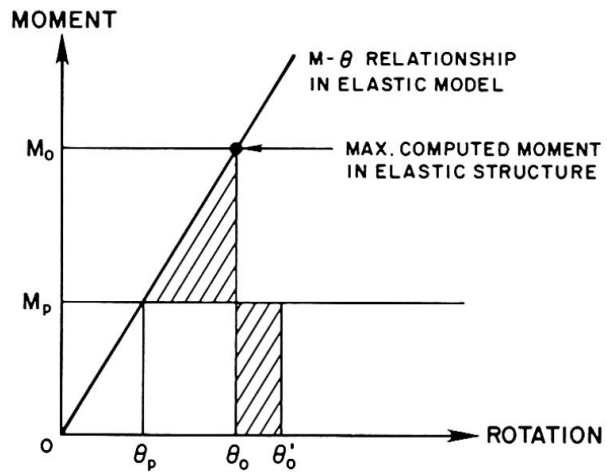

Fig. 2. Ductility Definition.

where M_0 is the maximum computed member moment based on an elastic model of the structure and M_p is member plastic moment capacity. θ_0 and θ_p are linearly related to M_0 and M_p .

A variant of the above approach consists of defining the maximum rotation θ_0' by generating the shaded rectangle to be of equal area to the shaded triangle in order to preserve equal energies for elastic and elasto-plastic cases. Unfortunately, either one of the above two schemes applies only for statically determinate cases. For example, using this approach for the three-story split K-framing system shown in Fig. 3 would be grossly in error. The relationship between the critical moments for the ultimate case (shown in Fig. 3b) to those for the elastic case (Fig. 3a) is not linearly related, nor are the rotations. For a more accurate estimation of the ductility demand of structural members and connections, elasto-plastic computer analyses of structures must be developed for use by the design engineers.

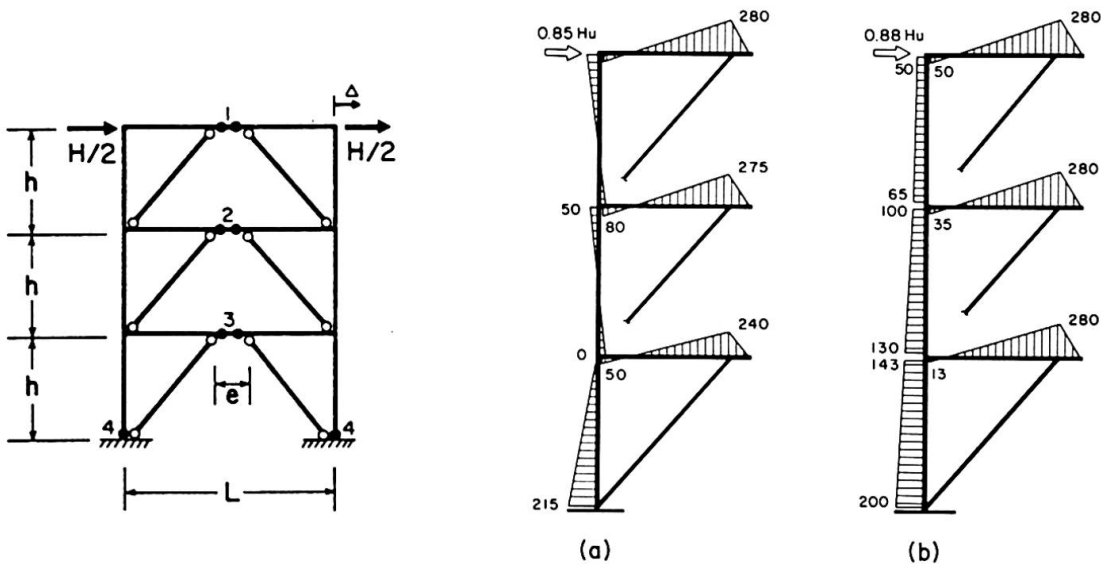

Fig. 3. Split K-Braced Frame. (a) Moments at First Yield. (b) Moments at Frame Ductility of 2 [8].



With the Canadians having already embraced plastic limit state as a basis for structural design, and with the US activity in the ACI and AISC in connection with the Load and Resistance Factor Design methods, the prospects for improving upon Eq. (1) seem good, and further developments in the plastic design methods appear imminent. The earlier emphasis on advocating plastic methods on the basis of economy seem ill-advised. On the other hand, such methods seem indispensable for a fuller comprehension of the problems in seismic design.

With a wider acceptance of plastic limit state as the basis in seismic design, one can foresee dynamic analyses becoming more sophisticated with new developments in the area of elasto-plastic response. At present, dynamic analyses are performed exclusively on the elastic basis.

The importance of a dynamic analysis can be illustrated by citing an example from Ref. 13. In this case, Paulay compares the distribution of moments in the columns as prescribed by the New Zealand code and what might happen during a severe earthquake (Fig. 4). The discrepancy is startling, calling for very different column reinforcement for the two cases. At 7.8 seconds, an elasto-plastic dynamic analysis shows no inflection points in the column along several stories, requiring a different pattern of reinforcement than that determined by the static analysis. The New Zealand code [17] makes special provisions for such a contingency.

Although this example is drawn from the design of a reinforced concrete building, the results are just as meaningful for steel columns. It is clear that under similar circumstances, the use of minimum column splices selected on the basis of static code analysis would be grossly inadequate.

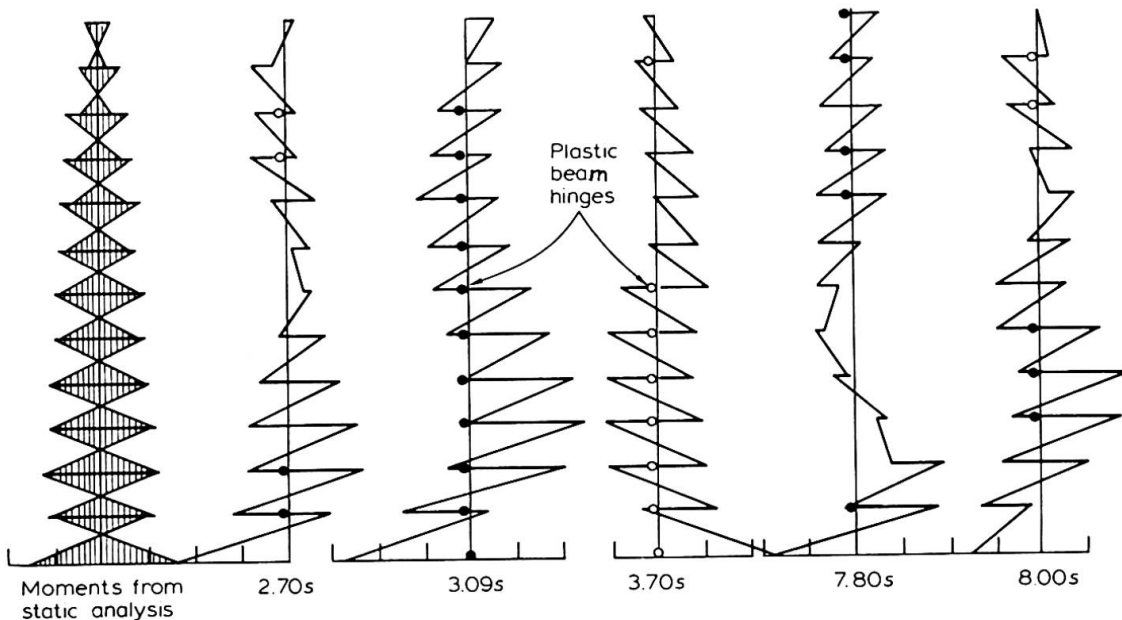

Fig. 4. A Comparison of Column Bending Moments During Instants of Large Earthquake Motion with Code-Specified Lateral Static Loading (after Paulay [13]).

5. ECCENTRICALLY BRACED STEEL FRAMES

As an illustration of the structural design process for seismic applications, the evolving novel scheme of bracing steel frames with diagonal braces having deliberate eccentricities at the joints will be discussed. First, the possible problems in the conventional steel framing for resisting lateral loads will be identified. Then the basic concept of eccentrically braced frames will be discussed, followed by an overview of the completed experimental studies of component behavior. Some feedback from full-size pseudo-dynamic experiments on a six-story steel building at Tsukuba, Japan [7], in which eccentric bracing was employed, will be presented.

In seismic design of structural steel framing systems for resisting lateral forces, either moment-resisting frames (MRFs) or diagonally braced frames are commonly employed. The MRFs are ductile, but tend to be too flexible, whereas the braced frames are stiff, but are not ductile. Therefore, both systems have an undesirable characteristic for seismic applications.

To optimize the behavior of MRFs, the panel zone, i.e., the column web between beam flanges, often requires reinforcement by means of doubler plates, and the beams may have to be made larger to control story drift. These aspects of the problem are illustrated in Fig. 5, where the contributions of the three main sources to story drift are identified for two beam-column subassembly experiments [10]. These are the flexural deflection of the columns, δ_c , rotation of the beams, δ_r , and shear deformation of the panel zone, δ_p . For a thin panel zone (Fig. 5a), δ_p can contribute significantly to the story drift. This effect can be reduced by using larger columns or reinforcing the panel zones by doubler plates. If this problem is resolved, beam rotation δ_r becomes the principal cause of story drift (Fig. 5b), and it becomes necessary to use larger beams than required for strength. Both remedies are economically unattractive.

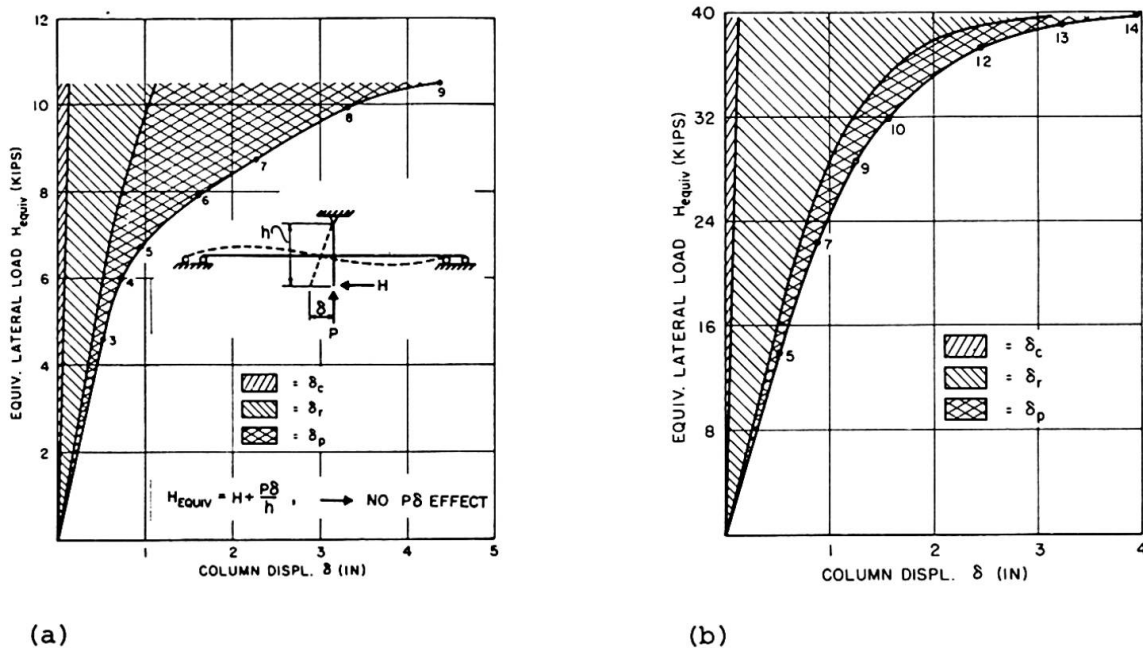

Fig. 5. Horizontal Displacement Components of Column with (a) Thin Web and (b) Thick Web [10].



Diagonal bracing provides an effective means for reducing story drift, and is an excellent solution for wind bracing. However, for seismic applications, it has a major difficulty because the tensile braces are ineffective during repeated cyclic stretching, and compression braces lose their capacity under repeating and reversing post-buckling loadings. The behavior of a strut in post-buckling range is illustrated in Fig. 6, where an initially concentrically loaded strut is subjected to a number of severe load reversals. The large decrease in compressive strength of the strut during reloading is striking. This intrinsic lack of compressive capacity reliability of a strut under cyclic loading raises serious objections to concentrically braced frames (CBFs) for applications in regions of high seismicity.

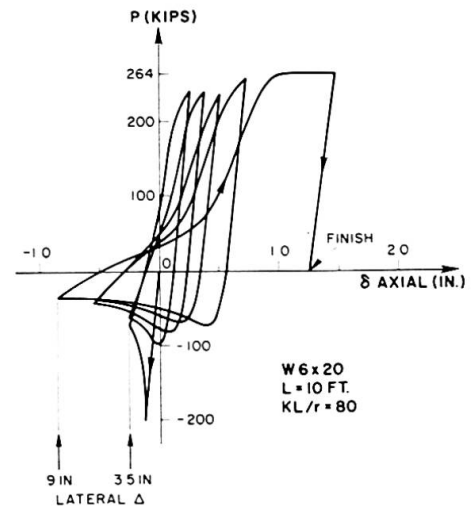

Fig. 6. Experimental Hysteretic Loops for Cyclically Loaded Strut [20].

A possible solution for steel framing for seismic design consists of a compromise between the two basic types of structural framing, i.e., between the moment-resisting and concentrically braced framing. This concept can be clarified by making reference to Fig. 7a [8], which shows the simplest eccentrically braced frame (EBF). When the brace eccentricity e is reduced to zero, one obtains the conventional CBF, whereas if $e = L$, one has an MRF. For all other values of e , the frame is an EBF. By making the diagonal member sufficiently strong so as not to buckle, but rather to cause yielding in the short link, the wanted behavior of an EBF is achieved. A parametric study of the elastic behavior of this simple frame is shown in Fig. 7b [8]. From this diagram, one

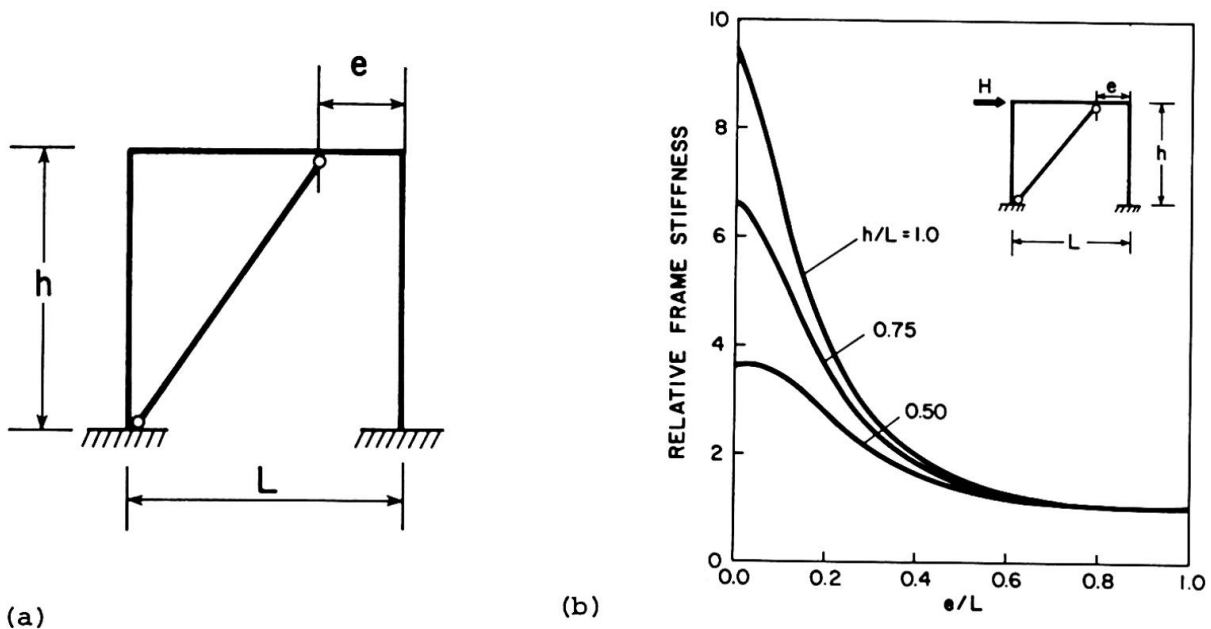

Fig. 7. (a) Simple Eccentrically Braced Frame. (b) Variations of Stiffness for Different Aspect Ratios with Constant Member Sizes [8].

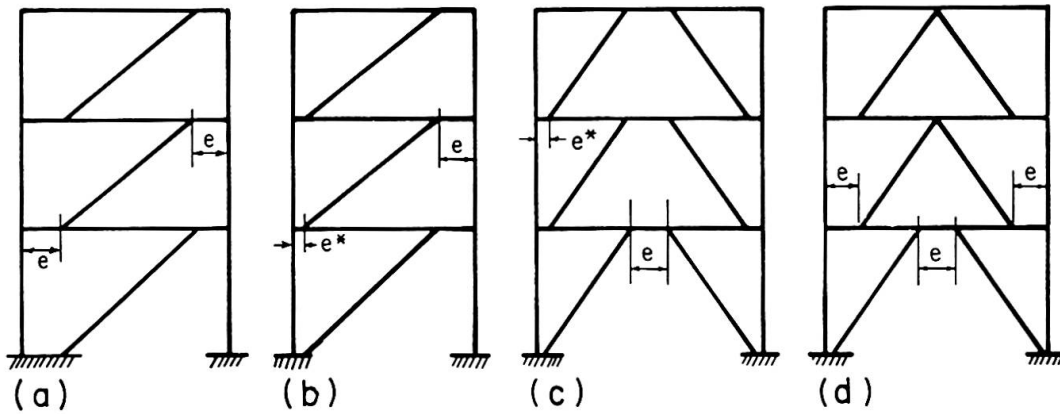

Fig. 8. Alternative Bracing Arrangements for Eccentrically Braced Frames [8].

can note that a large frame stiffness can be achieved by an EBF. On the other hand, by making these links sufficiently long, they can sustain the required plastic deformations; thus, a ductile framing system is obtained. Extensive experimental and analytical research has shown that it is possible to achieve these objectives for a variety of EBFs. Some examples of such framing are shown in Fig. 8 [8].

The basic experiments for a typical link for a split-K framing (Fig. 8c) were performed using the idealization shown in Fig. 9a [8]. To retain frame elastic stiffness, the links should be made as short as possible (Fig. 7a), consistent with their ability to sustain severe plastic deformations. At cyclic overloads these short links must maintain their strength while webs yield plastically. As such behavior was not anticipated in the codes, appropriate rules for stiffening the web were developed [12]. An example of a correctly designed link at the end of a severe cyclic test is shown in Fig. 9b.

Additional experiments had to be performed on links occurring next to columns (Fig. 8a,b, and d). For such cases, in the elastic range of behavior, significantly larger moments develop next to the columns than at the brace end. The extent of moment equalization and web yielding was studied using the model

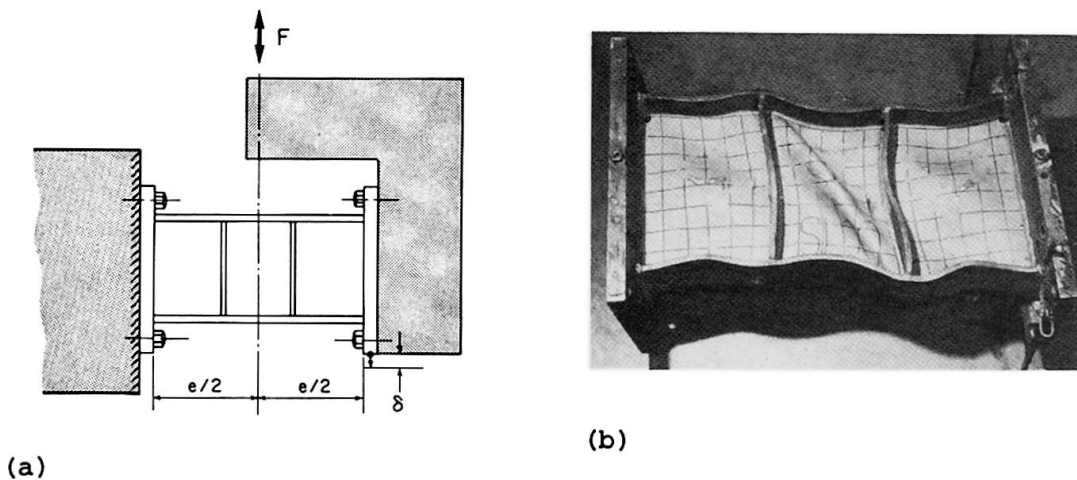

Fig. 9. (a) Schematic Diagram of Test Setup for Interior Link. (b) Well Stiffened Link at End of Severe Cyclic Test [8,12].



shown in Fig. 10b. By applying equal cyclic displacements at the two load points, the behavior of this isolated beam simulates the conditions that would develop in a frame in the inelastic range (Fig. 10a) [9]. For a better simulation of the link behavior in a building, experiments on steel beams with a composite floor were designed, and experimental work is in progress (Fig. 11) [15]. The adopted model is designed to simulate both the interior links (Fig. 11a) and those occurring next to the columns (Fig. 11b).

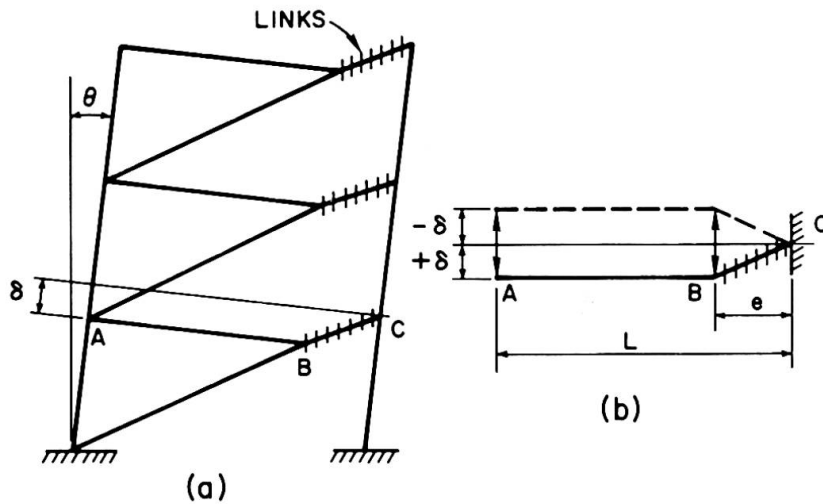

Fig. 10. (a) Collapse Mechanism of a Frame. (b) Schematic Diagram of Test Setup for Exterior Link.

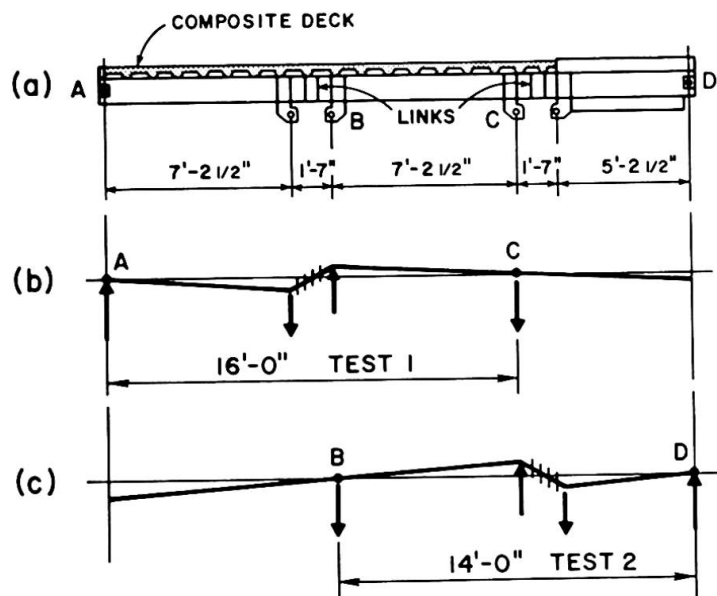

Fig. 11. (a) Composite Floor Beam with Links. (b) and (c) Schematic Diagrams of Test Setups for Interior and Exterior Links.



An analytical procedure for preliminary design of EBFs using plastic methods of analysis has been developed [9]. Experience using this procedure shows its versatility and great simplicity. Elastic analyses of plastically designed frames indicate excellent behavior of such frames. Relating these analyses to probabilistic evaluations of designs remains a challenging task.

6. SUMMARY

In practice, the structural design process with seismic considerations is reduced to simple terms by prescribing deterministic lateral static loads. Usually, an elastic analysis is performed for sizing the members. The deficiencies of this approach have been emphasized in this paper. As a first step, it is advocated to adopt a true concept of limit state design, which would usher plastic methods into the analysis and design process. Improvements in analytical solutions leading to better agreement with experimental results are sorely needed. Research on isolated members alone is no longer adequate. Experimentation must continue to be conducted at least at the level of subassemblies.

Hopefully, meaningful advances will be made in rapid dynamic inelastic analysis of structures. Correlations with pseudo-dynamic tests as well as with experiments on shaking tables are needed.

Engineers must become more aware of the size effect. To date, experiments have been performed on very small specimens. Particularly with steel, the concepts of fracture mechanics for low-cycle fatigue need to become generally appreciated. The problem of cyclic bond deterioration in reinforced concrete as well as a more precise knowledge of confinement effects need further attention. Until such time as these questions will be more accurately resolved, seismic design of structures will remain to some extent an art, and will continue to tax the ingenuity of the engineer.

ACKNOWLEDGEMENTS

The author is grateful to the National Science Foundation (current Grant CEE-8207363) for support of research which helped to mold the point of view expressed in this paper. However, any opinions, recommendations, and conclusions expressed are those of the author and do not necessarily reflect the views of the sponsor. Messrs. F. Filippou, K. Kasai, and J.O. Malley read the draft of the paper and offered useful suggestions. Cindy Polansky assisted in the editing and typing of the manuscript.

REFERENCES

1. Applied Technology Council, ATC-3, "Tentative Provisions for the Development of Seismic Regulations for Buildings," National Bureau of Standards, U.S. Department of Commerce, Washington, D.C., June 1978.
2. "City of Los Angeles Building Code," 1982 ed., Department of Building and Safety, Los Angeles, CA.
3. Eighth World Conference on Earthquake Engineering, Proceedings, International Association for Earthquake Engineering, San Francisco, CA, July 1984.
4. Committee on Natural Disasters, "El-Asnam, Algeria Earthquake, October 10, 1980," Earthquake Engineering Research Institute, Jan. 1983.

5. Engineering News-Record, "Exotic Bracing Helps Frame Seattle's Tallest," Vol. 212, No. 11, March 15, 1984, pp. 28-29.
6. FOUTCH, D., "Design and Construction of the Full-Scale Specimen and Results of the Phase I Tests," U.S.-Japan Cooperative Research Program for Structural Steel Buildings, J. of Structural Engineering, ASCE (in preparation).
7. GOEL, S.C., "Results of the Phase II Full-Scale Tests and Analytical Correlations," U.S.-Japan Cooperative Research Program for Structural Steel Buildings, J. Structural Engineering, ASCE (in preparation).
8. HJELMSTAD, K.D., and POPOV, E.P., "Characteristics of Eccentrically Braced Frames," J. of Structural Engineering. Vol. 110, No. 2, Feb. 1984, pp. 340-353.
9. KASAI, K. and POPOV, E., "On Seismic Design of Eccentrically Braced Steel Frames," 8th World Conference on Earthquake Engineering, Proceedings, International Association for Earthquake Engineering, San Francisco, CA, July 1984.
10. KRAWINKLER, H., BERTERO, V.V., and POPOV, E.P., "Inelastic Behavior of Steel Beam-to-Column Subassemblages," Report No. EERC-71-7, University of California, Berkeley, Oct. 1971.
11. American Institute of Steel Construction, "Load and Resistance Factor Design Specifications for Structural Steel Buildings (Proposed)," Chicago, Sept. 1983.
12. MALLEY, J.O. and POPOV, E.P., "Design Considerations for Shear Links in Eccentrically Braced Frames," Report No. UCB/EERC-83/24, University of California, Berkeley, Nov. 1983.
13. PAULAY, T., "Deterministic Seismic Design Procedures for Reinforced Concrete Buildings," Engineering Structures, Vol. 5, No. 1, Jan. 1983, pp. 79-86.
14. American Society of Civil Engineers, Plastic Design in Steel, No. 41, 2nd ed., 1971.
15. POPOV, E.P. and RICLES, J., "Cyclic Behavior of Composite Floors at Eccentric Links," J. of Structural Engineering (in preparation).
16. Seismology Committee, "Recommended Lateral Force Requirements and Commentary," Structural Engineers Association of California, San Francisco, CA.
17. Standards Association of New Zealand, "Code of Practice for the Design of Concrete Structures," Draft New Zealand Standard NZS3101, Parts 1 and 2, 1982.
18. WIGHT, J. and SATTARY, V., "Design and Testing of Full-Scale Structures," U.S.-Japan Cooperative Research Program for Reinforced Concrete Buildings, J. of Structural Engineering, ASCE (in preparation).
19. International Conference of Building Officials, "Uniform Building Code," 1982 ed., Whittier, CA, 1982.
20. POPOV, E. P., "Seismic Behavior of Structural Subassemblages," J. of the Structural Division, ASCE, Vol. 106, No. ST7, July 1980, pp. 1451-1474.
21. Concrete Reinforcing Steel Institute, "Case History Report: Ductile Concrete for Seismic Zones," Bulletin No. 25, Schaumburg, Il, 1984.

Major Construction and Other Failures – Lessons for Project Teams

Domages majeurs – Leçons pour les groupes de projet

Bedeutende Schadenfälle – Lehren für die Projektierenden

Stephen WEARNE
Project Man. Consult.
Alderley Edge, UK



Stephen Wearne worked for 18 years in engineering, chiefly on the design and management of power projects in the UK, Venezuela and Japan. He then started university teaching and research in project management, and until recently was Professor of Technological Management at the University of Bradford, Yorkshire, UK.

SUMMARY

Amongst the many successful achievements of construction around the world there have been some serious failures during the erection of structures. The incidence of failures is generally decreasing but the concentration of energy which may be released in any one failure is increasing. There is therefore a growing need to anticipate potential failures as well as learn from those that do occur. The evidence referred to in this paper indicates that major construction failures are rarely caused by novel technological problems but always involve two or more organizations. Attention is therefore needed to the organizational and contractual lessons of these and analogous failures.

RESUME

A côté des nombreuses réalisations couronnées de succès, il y a aussi des accidents majeurs lors de la réalisation de constructions. Le nombre de ces accidents a tendance à décroître, mais la concentration d'énergie qui peut être libérée lors d'un accident est en train de croître. Il est nécessaire de prévenir les accidents et de tirer les leçons de ceux qui se produisent. Les exemples cités dans cet article indiquent que les principales déficiences sont rarement créées par des problèmes technologiques nouveaux, mais résultent toujours de la présence de deux organismes ou plus. Il est, donc, important de tirer un enseignement de ces déficiences et d'autres déficiences similaires pour l'organisation des travaux et l'élaboration des contrats.

ZUSAMMENFASSUNG

Neben den vielen grossen Bauerfolgen in der ganzen Welt sind auch einige schwerwiegende Fehlleistungen bei der Errichtung von Bauten zu beobachten. Die Häufigkeit der Bauschäden nimmt allgemein ab, im Gegensatz zur Energiekonzentration, die bei jedem einzelnen Fehlschlag freigesetzt werden kann. Es wird deshalb immer nötiger, sowohl potentielle Defekte vorzusehen als auch aus den bereits vorgekommenen Fehlleistungen eine Lehre zu ziehen. Das in dieser Arbeit angesprochene Beweismaterial deutet darauf hin, dass grosse Baudefekte selten durch neuartige technologische Probleme verursacht werden, sondern dass sie stets an den Nahtstellen zwischen beteiligten Partnern entstehen. Besonders zu beachten sind aus diesem Grunde die sich für Organisation und Auftragsvergabe ergebenden Lehren, die aus diesen ähnlichen Fehlleistungen gezogen werden müssen.



1. FAILURE

Dictionaries define failure as non-performance or an unacceptable want of success.

The adjective "unacceptable" is important. Success and safety in engineering are matters of probabilities, as in life generally. Controversial as it may seem when stated publicly, there is no certainty that anything is safe or that any one decision will lead to one predictable result.

A failure is therefore a result that falls outside an acceptable range. So is luck, but that word implies that the result is welcome. Failure is unwelcome, to society, an organization, or to individuals. Use of the words 'major failure' implies that the result is serious and should have been avoided.

What is serious is relative. Risks at work vary from job to job, and are usually different to the risks when not at work (Most jobs in Western countries are safer than being at home - construction is an exception). A definition of seriousness is that a major failure increases the chances of damage to people or things by an order of magnitude or more. It is these failures that attract public attention.

2. SIGNIFICANCE OF FAILURES

References cited in an earlier paper indicated that there is continuing improvement in the incidence of failures of engineering products. [1] The frequency and seriousness of failures are irregular, but in products as different as aircraft, bridges and process plant it is clear that the probabilities of failure have reduced. This is to the credit of engineers, their education and professional societies, leading employers, inspecting authorities and all who have paid the costs of higher standards.

On the other hand the failures that do now occur tend to be more serious, to the people affected at work, and to society. The reasons lie in two trends in the evolution of all sectors of industry:

- The pursuit of economy of scale. Larger plant and structures promise economy of scale in production and in the use of services. There is a diminishing return from greater scale, but the trend continues though irregularly. The consequence is greater concentration of physical and financial risks.
- The pursuit of optimization in design. Greater technological expertise has led to many advances in project performance and construction safety, but also has led to more 'economic' use of structural and other materials. [2] The physical consequences are to reduce structural redundancies with the result that the failures that do occur tend to be more rapid and less likely to show prior warning signs. The organizational consequences are that people and organizations are more specialized and their work is more interdependent.

The potential effects of a failure are therefore greater, which is presumably why there has been public pressure and legislation in Western countries for better anticipation and prevention of industrial hazards, but less and less can any one person be expert about all of a project and there are fewer directly relevant failures from which to learn. We therefore need to study those that occur in construction and any analogous failures in other industries.

3. REPORTS OF FAILURES

As might be expected, the most serious failures are investigated systematically and reported publicly. Many others are not reported, and near misses may go unnoticed. The evidence available is therefore not comprehensive, and ideally evidence of the causes of failures should be considered together with evidence of

the causes of successes. Expenditure on the latter is regrettably rare. Action to remedy what appears to be a fault considered in isolation could damage what were predominantly satisfactory ways of engineering and managing projects. The published reports of serious failures show that many of the decisions made were satisfactory. We therefore have to learn from faults but be cautious about producing new rules.

The important general conclusion from reports of serious and lesser failures is that none were caused by hitherto unknown physical phenomena that acted without warning. [3,4,5] All were caused by not knowing or using existing information. They were therefore due to problems of perception and communication.

4. SPECIFIC LESSONS

The problems of perception and communications observed in reports of failures seem obvious afterwards. With the advantage of hindsight it is relatively easy to say how something might have been avoided. The actions needed may not be so obvious amidst the pressures of cost, time, contractual and managerial pressures typical in construction. What appear to be the lessons of failures are therefore set out here in the form of a check list, for use as reminders of questions which may be important in planning, organizing and supervising construction.

4.1 Designers' requirements

- Are design requirements practicable ?
Case: Box girder bridges, fabrication tolerances. [12]
- Have design requirements been implemented ?
Case: Kings bridge, material testing. [13]

4.2 Site data

- Are all parties working to appropriate data ?
Case: Ferrybridge cooling towers. [14]

4.3 Construction conditions

- Is the erection method compatible with design ?
Case: West Gate bridge. [15]
- Are erection conditions known and checked ?
Case: Cleddau and other box girders. [12,16]
- Are all temporary loads checked through to supports ?
Cases: Barton bridge, stability of temporary towers. [6]
Barton bridge, foundations for towers.
- Who looks for and who interprets warning signs ?
Case: West Gate bridge.
Analogous case: Sea Gem drilling rig. [17]
- Who checks that specified checks have been done ?
Analogous case: Aberfan tip slide. [18]
- Would hazard analysis reduce the potential consequences of a failure ?
Case: West Gate bridge, location of labour huts.



5. MORE GENERAL LESSONS

After a serious failure it is to be expected that investigations should lead to recommendations on how repetition of that type of failure should be avoided, a good UK example being the work of an advisory committee on the safety of false-work. [19] The problems of individual perceptions of risk and virility complexes are also the subject of investigations and conferences. [7,20] These are obviously necessary, it appears recurrently.

Less obvious from studies of particular failures and accidents in construction are the following more general questions:

5.1 Symmetry in design

- Are symmetrical components apparently more stable during construction than they are, even to experienced people ?

Case: Barton bridge, plate girders.

- Should symmetrical components be erected whole ?

Case: West Gate bridge.

- Can symmetrical components be erected wrongly ?

Cases: Concrete beams used upside down.

Analogous cases: Bravo field blow-out preventer and other directional valves with symmetrical connections. [21]

5.2 Alterations to existing structures

- Is an alteration or extension to a structure compatible with the first design ?

Cases: Sea Gem drilling rig.

Alexander Kielland platform. [22]

Analogous case: Flixborough by-pass pipe. [23]

6. ORGANIZATIONAL RELATIONSHIPS

Failures of perception, communication and not using knowledge that exists are organizational problems, within organizations and in the contractual and other relationships between them in designing and constructing projects. The general problem is one of making information and ideas known to people who are not aware that they need them. A particular problem is the 'decoy' effect that individuals and organizations tend to concentrate on the first recognizable feature of a situation and neglect further information and questions. [8]

There is no evidence that the greater size or complexity of projects have been direct causes of failure. The larger a project the greater may be the physical and social risks, but the growth in size of projects typical of all industries has been accompanied by decrease in the incidence of failures. The organizational problem is in the greater number and variety of specialist individuals and organizations that have roles in design and construction. This trend continues regardless of size of project. The increasing risk is that no one person has the expertise, information, time, responsibility and authority to be in control of design and construction of a project as a whole. One such person in control of decisions might have been able to anticipate at least some of the failures reviewed here. [8,9] Appointing one person in control is clearly the lesson of studies of how to reduce or avoid delays and extra costs in construction, not only to improve safety. [24] It might therefore seem surprising that appointing a 'project director' is not common practice, to achieve satisfactory commercial results as well as reduce the risk of a serious physical failure.



Divided control is much more common, it appears in Europe and North America. One explanation may be that managers of client organizations accept that the above lesson is logical, but they also tend to see their project as unique and under the pressures of their jobs concentrate on problems as they arise rather than on general ideas on how to anticipate them.

One remedy may be that engineers and their clients should be more scientific about who makes decisions. We also need to know whether a tendency to error can be predicted in people or in new types of construction. [10,11] And we need to be trained to analyze our assumptions [8], for instance to question the common engineering assumption that checking a calculation, etc. reduces the chance of error. The tendency after failures or thoughts of potential failures is to add formal checks. The knowledge that work will be checked could lead to less care to do it well or behaviour to suit the checking system, coupled with greater but false confidence that the result will be safe. [7]

7. INVESTIGATIONS OF FAILURES

The primary purpose of investigations into failures is to detect their cause and recommend means of avoiding repeats. Such investigations properly begin with the physical evidence from the failed material, and then seek an explanation of the sequence of failure. Nearly all investigations succeed in achieving a complete physical explanation.

If the origins of these unhappy events are in the perception of problems and communication of information, the relationships between the people employed on a project prior to failure should be investigated as scientifically as are the physical events. For this purpose the teams that are appointed to investigate serious failures should include at least one person experienced in analyzing organizational and contractual relationships but not familiar with the particular industry and therefore likely to be innocent of its assumptions.

REFERENCES

1. WEARNE S H, A Review of Reports of Failures. Proc IMechE, vol 193, 1979, 125-136 and S 39-44.*
2. BLOCKLEY D I & HENDERSON J R, Structural Failures and the Growth of Engineering Knowledge. Proc ICE, vol 68, part 1, 1980, 719-728 and vol 70, 567-579.
3. ASCE, Structural Failures. 1973.
4. MELCHERS R E, Studies of Civil Engineering Failures. Report 6/1976, Civil Engineering Research Reports, Monash University.*
5. BLOCKLEY D I, Structural Failures. Proc ICE, vol 62, 1977, part 1, 51-74.* (See also the reports listed below).
6. MERCHANT W, Three Structural Failures. Proc ICE, vol 36, 1967, 499-532 and vol 38, 679-735.
7. HALE A R & PERUSSE M, Attitudes to Safety: Facts & Assumptions. Conference on Research into the Causes and Prevention of Industrial Accidents, 1977, Centre for Socio-Legal Studies, Oxford.
8. TURNER B A, The Origins of Disaster. Wykeham Press, 1978.
9. BARBER E H E, Engineers, Lawyers and the Failure of Two Bridges. J1 Inst. Engrs Australia, vol 45, 1973, 4-6 & 12.
10. PUGSLEY A, Prediction of Proneness to Structural Accidents. The Structural Engineer, vol 51, 1973, 195-6.



11. WALKER A G & SIBLEY P B, When Will an Oil Platform Fail? New Scientist, 12 February 1976, 326-8.

Reports

12. Inquiry into the Basis of Design and Method of Erection of Steel Box Girder Bridges, interim report, 1971, HMSO.
13. Royal Commission into the Failure of Kings Bridge, Melbourne. Government of Victoria, 1963.
14. Committee of Inquiry into the Collapse of Cooling Towers at Ferrybridge. Central Electricity Generating Board, UK, 1966.
15. Royal Commission into the Failure of West Gate Bridge. State of Victoria, 1971.
16. Koblenz (bridge collapse). The Consulting Engineer, 1972, vol 36, no 1, 23-24.
17. Inquiry into Accident to the Drilling Rig Sea Gem. Ministry of Power, UK, 1967. HMSO.
18. Tribunal Appointed to Inquire into the Disaster at Aberfan 21 October 1966. HMSO, UK.
19. Advisory Committee on Falsework. 1975, HMSO.
20. Safety in Civil Engineering. Proc ICE, 1969, vol 42, 143-152.
21. The Uncontrolled Blow-Out on the Ekofisk Field (the Bravo Platform). Norwegian Public Reports, NOU 1977:47.
22. The Alexander Kielland Accident. Norwegian Public Reports, NOU 1981:11.
23. Court of Inquiry into the Flixborough Disaster. Department of Employment, UK, 1975.
24. Project Control During Construction. Technological Management, University of Bradford, report TMR 17, 1984.

* includes an extensive list of references.



Conclusions to Main Theme A The Structural Design Process

Hansruedi SCHALCHER

Dr. Eng.
Schalcher & Partner
Zurich, Switzerland

After the opening of the first session of the congress by The President of IABSE, the general reporter gave a short introduction into main theme A "The structural design process". He explained the various aspects of engineering design and pointed out some future trends. The first main speaker illustrated the specific problems of planning and construction of offshore structures with emphasis on areas with low temperatures. The second contribution gave an overall view of the actual techniques and the future development in bridge design, in particular with regard to cable-stayed bridges.

After coffee break four speakers elaborated their view about four different aspects of design: Problem identification and planning, choice of structural concepts, structural design process with seismic considerations and major construction and other failures.

Session A was too short to deal with all main problems related to design. But the variety of experiences and examples that were presented showed in an impressive manner that the engineer's work should not only concentrate on structural analysis, loads and forces or materials. The engineer should approach design on a broader basis. He should be aware of the general functions of a structure and its interdependence with the environment. A further, important outcome of this session was the statement, that design is not a well known and already established science, but it is a skill which needs permanent training and future development.

Leere Seite
Blank page
Page vide