

Nail-plates as shear connectors in composite timber and concrete structures

Autor(en): **Girhammar, Ulf Arne**

Objektyp: **Article**

Zeitschrift: **IABSE congress report = Rapport du congrès AIPC = IVBH
Kongressbericht**

Band (Jahr): **12 (1984)**

PDF erstellt am: **24.09.2024**

Persistenter Link: <https://doi.org/10.5169/seals-12222>

Nutzungsbedingungen

Die ETH-Bibliothek ist Anbieterin der digitalisierten Zeitschriften. Sie besitzt keine Urheberrechte an den Inhalten der Zeitschriften. Die Rechte liegen in der Regel bei den Herausgebern.

Die auf der Plattform e-periodica veröffentlichten Dokumente stehen für nicht-kommerzielle Zwecke in Lehre und Forschung sowie für die private Nutzung frei zur Verfügung. Einzelne Dateien oder Ausdrucke aus diesem Angebot können zusammen mit diesen Nutzungsbedingungen und den korrekten Herkunftsbezeichnungen weitergegeben werden.

Das Veröffentlichen von Bildern in Print- und Online-Publikationen ist nur mit vorheriger Genehmigung der Rechteinhaber erlaubt. Die systematische Speicherung von Teilen des elektronischen Angebots auf anderen Servern bedarf ebenfalls des schriftlichen Einverständnisses der Rechteinhaber.

Haftungsausschluss

Alle Angaben erfolgen ohne Gewähr für Vollständigkeit oder Richtigkeit. Es wird keine Haftung übernommen für Schäden durch die Verwendung von Informationen aus diesem Online-Angebot oder durch das Fehlen von Informationen. Dies gilt auch für Inhalte Dritter, die über dieses Angebot zugänglich sind.

Nail-Plates as Shear Connectors in Composite Timber and Concrete Structures

Connecteurs à dents et résistance au cisaillement de structures mixtes bois/béton

Nagelplatten als Schubverbindungen für Verbundkonstruktionen aus Holz und Beton

Ulf Arne GIRHAMMAR

Res. Prof.
RFSA
Märsta, Sweden

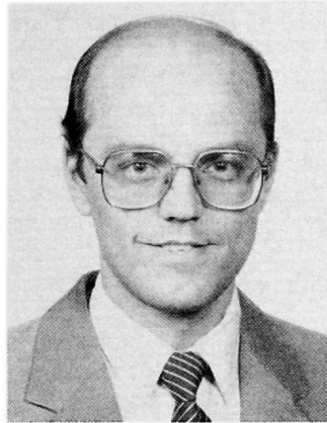

SUMMARY

Composite timber and concrete structures are often used as floors, walls and in bridges. Nail-plates as shear connectors in such timber-concrete composites have been studied experimentally in push-out tests. The load-slip behaviour and failure modes have been investigated for different designs of the connection. Results from about 50 push-out tests are discussed and an optimum design of the connection is recommended. Modes of failure are shear failure of the nail-plates and anchorage failure in the concrete plate. Design values for the slip modulus and shear capacity are given.

RESUME

Des éléments de structures mixtes bois/béton sont souvent utilisés dans les planchers, parois et ponts. Les connecteurs à dent ont fait l'objet de nombreux essais pour déterminer la résistance au cisaillement de structures mixtes bois/béton. Leur comportement au glissement et leur rupture ont été étudiés pour divers types de connecteurs. Le résultat de 50 essais est présenté et un dimensionnement optimal proposé. Le genre de rupture est généralement dû l'effort tranchant dans le connecteur ou à la faiblesse de l'ancrage dans le béton. Des valeurs de projet sont données pour le module de glissement et la résistance au cisaillement.

ZUSAMMENFASSUNG

Verbundkonstruktionen aus Holz und Beton werden auf den Decken, Wänden und auch in Brücken verwendet. Nagelplatten als Schubverbindungselemente wurden experimentell untersucht. Das Last-Schlupf-Verhalten und die Brucharten wurden an verschiedenen Verbindungstypen untersucht. Die Resultate aus 50 Versuchen werden diskutiert und Bemessungsverfahren für Verbindungen werden empfohlen. Als Brucharten treten Schubversagen der Nagelplatten und Verankerungsbrüche im Beton auf.



1. INTRODUCTION

Composite structures of timber and concrete have long been used in building and bridge construction. A special composite timber-concrete wall element has been developed in Sweden [1]. A cross section of the wall element is shown in fig. 1. One essential feature of this type of composite element is the shear connection between the timber studs and the concrete plate. The function of the shear connection is to absorb the shear forces between the submaterials in order to develop composite action, and to prevent the transversal separation of the timber studs from the concrete plate. Nails, bolts, glue or cutouts are usually used to develop shear connection in timber-concrete composites [2,3,4]. For this special wall element nail-plates are used as shear connectors [5,6]. The details, dimensions and strength data of the nail-plates used are shown in fig. 2.

The load-slip behaviour and failure modes of the nail-plates as shear connectors in the composite timber-concrete wall elements have been studied experimentally. Besides the load and slip capacities, the slip modulus, k [N/m], is the important parameter of the load-slip characteristics. The possible failure modes of the shear connection are: (i) failure of the nail-plates in tension/compression and shear; (ii) anchorage failure of the nail-plates in the timber studs due to failure of the teeth of the nail-plates or of the wood; and (iii) anchorage failure of the nail-plates in the concrete plate due to failure of the bond between the nailplates and the concrete or of the concrete plate. About 50 push-out tests on the nail-plate shear connectors have been carried out. Several variables, such as friction between the studs and plate, the reinforcement around the nail-plates embedded in the concrete plate, the distance between the nail-plates and the edge and the end of the concrete plate, respectively, and the length and the inclination of the part of the nail-plates embedded in the concrete plate were studied in the tests. Specimens with structural details of the shear connection, which correspond to those in factory-made composite elements (fig. 1), were used as a reference in this comparative study.

2. TESTING PROGRAM AND TEST RESULTS

In order to determine the load-slip and the failure characteristics of the nailplate shear connections in the composite wall elements, two kinds of test series were carried out. One series of preliminary "push-out" tests was carried out directly on the factory-made composite elements and another series of regular push-out tests on specimens made in the laboratory. The objective of the first series was to study the behaviour of the nail-plate shear connectors in real composite elements and also as a comparative study of the effects between factory-made and laboratory-made specimens. The objective of the second series was to find a more optimum design of the shear connection by varying the parameters of the test specimens one at a time and comparing the results to those of the standard specimens, which correspond to fig. 1.

2.1 Push-out tests on factory-made composite wall elements

The timber studs of the wall element were cut into pieces in such a way that each contained 2-5 nail-plates and that room was made for the force to be applied as shown in fig. 3. The tests were divided into two groups: (i) tests on specimens that were situated in the interior of the element (inner tests); (ii) tests on specimens that were situated at the end (end tests); see fig. 4. The test set-up is shown in fig. 5; the element was clamped to a support, the load was applied at the clamped end and the slip was measured at the level of the nail-plates. Only force controlled tests were performed.

The test results concerning the load-slip characteristics of the inner test specimens and the end test specimens are shown in figs. 6 and 7, respectively. In each group the specimens were divided into three subgroups: (i) specimens where friction could be expected to be high being as long pieces of timber stud (which were fixed with 5 nail-plates) were used, and that the timber studs happened to be partially embedded in the concrete plate; (ii) specimens where friction could be expected to be lesser than in (i) being as short pieces of wood (which were fixed with 2 nail-plates) were used and that the timber studs were partially embedded; and (iii) specimens where friction could be expected to be low being as short pieces of wood (which were fixed with 2 nail-plates) were used and where there happened to be a gap between the timber stud and the concrete plate. The load-slip curves in figs. 6 and 7 are mean values of 1-3 tests.

As shown in figs. 6 and 7, the load-slip curves are approximately bilinear. The first linear part of the curve is due to the elastic shearing of the nail-plates and friction between the wood and the concrete. The second part of the curve is due to the plastic and strain-hardening shearing of the nail-plates. The friction or bond due to embedment only influences the first linear part of the curve. In the strain-hardening range the excessive deformation of the nail-plates causes the timber studs to be pressed against the concrete plate and thus develop friction between the wood and the concrete. This friction is presumably much less than the friction due to embedment. The effect of loading and unloading in one of the tests is also shown in fig. 6.

The ultimate loads are determined either by shear failure in the nail-plates or anchorage failure in the concrete plate, cf. the failure modes (i) and (iii) in chapter 1. In the case of inner tests, most failure modes were in shear of the nail-plates, but a few modes were in cracking of the concrete edge as shown in fig. 9. In the case of end tests, the most frequent failure mode was cracking of the end or corner of the concrete plate when the nail-plates were situated on the outside of the timber stud near the edge of the concrete plate (2a in fig. 3), and shearing in the nail-plates when the nail-plates were situated on the inside of the timber stud (2b in fig. 3) as shown in fig. 10. It is evident from figs. 6 and 7 that anchorage failure/cracking of concrete somewhat lowers both the load and the slip capacity. In order to fully use the capacity of the nail-plates, the distance between the nail-plates and the edge and the end of the concrete plate, respectively, should be large enough or reinforcement should be placed around the nail-plates.

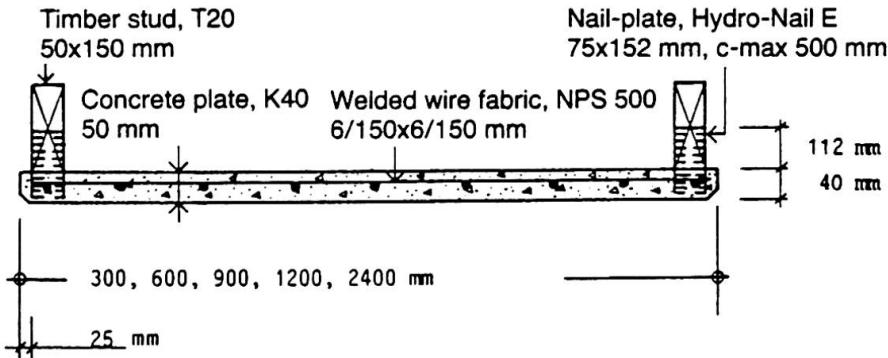

Fig. 1 Cross section of the composit timber-concrete wall element

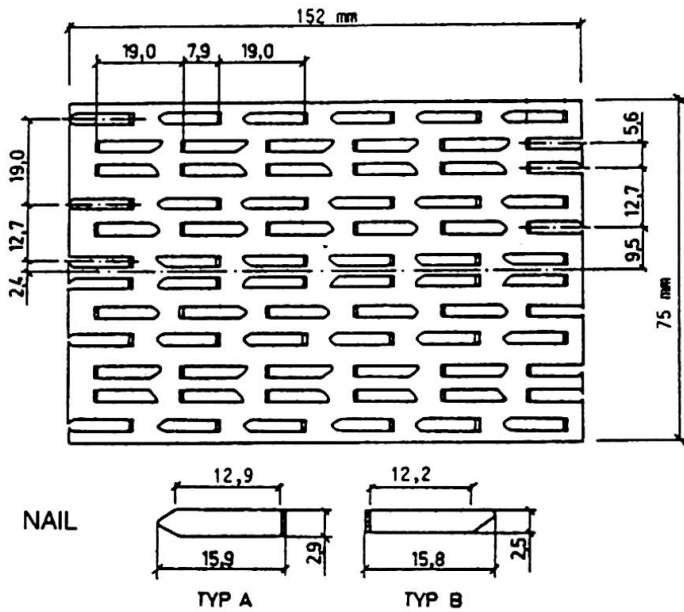

PLATE STRINGER (a typical stringer between the punched nails)
 $h = (15,9+12,9+15,8+12,2)/4 = 14,2$ mm
 $b = (75-6 \cdot 2,9-6 \cdot 2,5)/12 = 3,6$ mm
 $t = 1,3$ mm (plate thickness)

STRENGTH DATA

- $f = 124$ MPa (allowable stress)
- $f^a = 227$ MPa (yield stress)
- $f^y = 330$ MPa (ultimate stress)
- $E^u = 210$ MPa (modulus of elasticity)
- $\epsilon = 0.11\%$ (yield strain)
- $\epsilon^u = 40-60\% \cdot \delta_5$ (ultimate strain)
- $\delta_5 = 20\%$ (elongation at rupture)

Fig. 2 Details, dimensions and strength data of the nail-plates

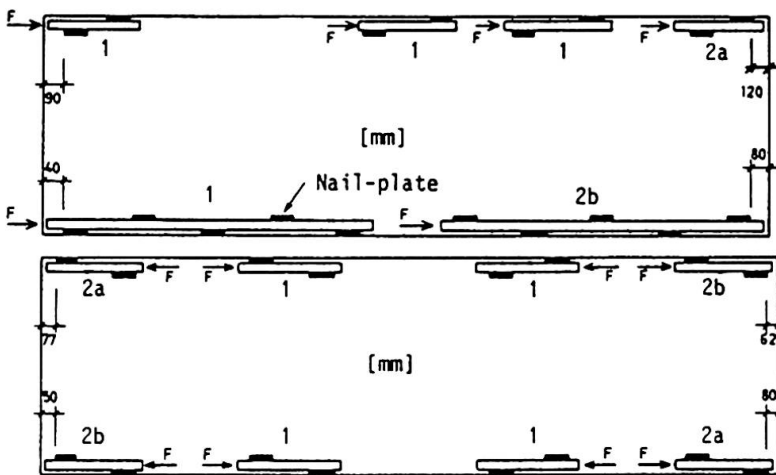

Fig. 3 "Push-out" test specimens on factory-made wall elements

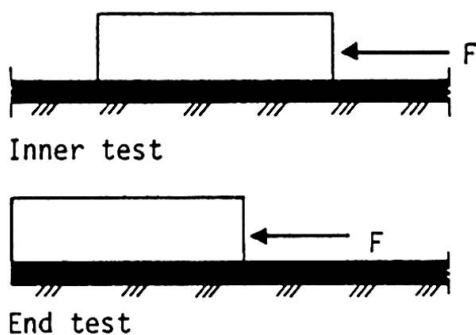

Fig. 4 Two kinds of "push-out" tests

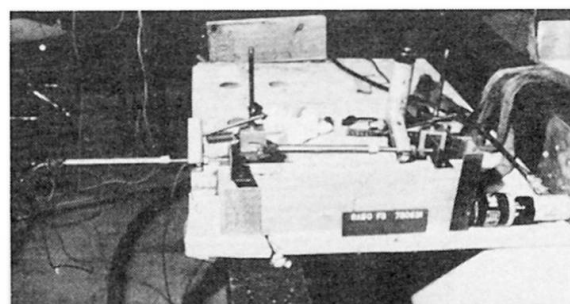
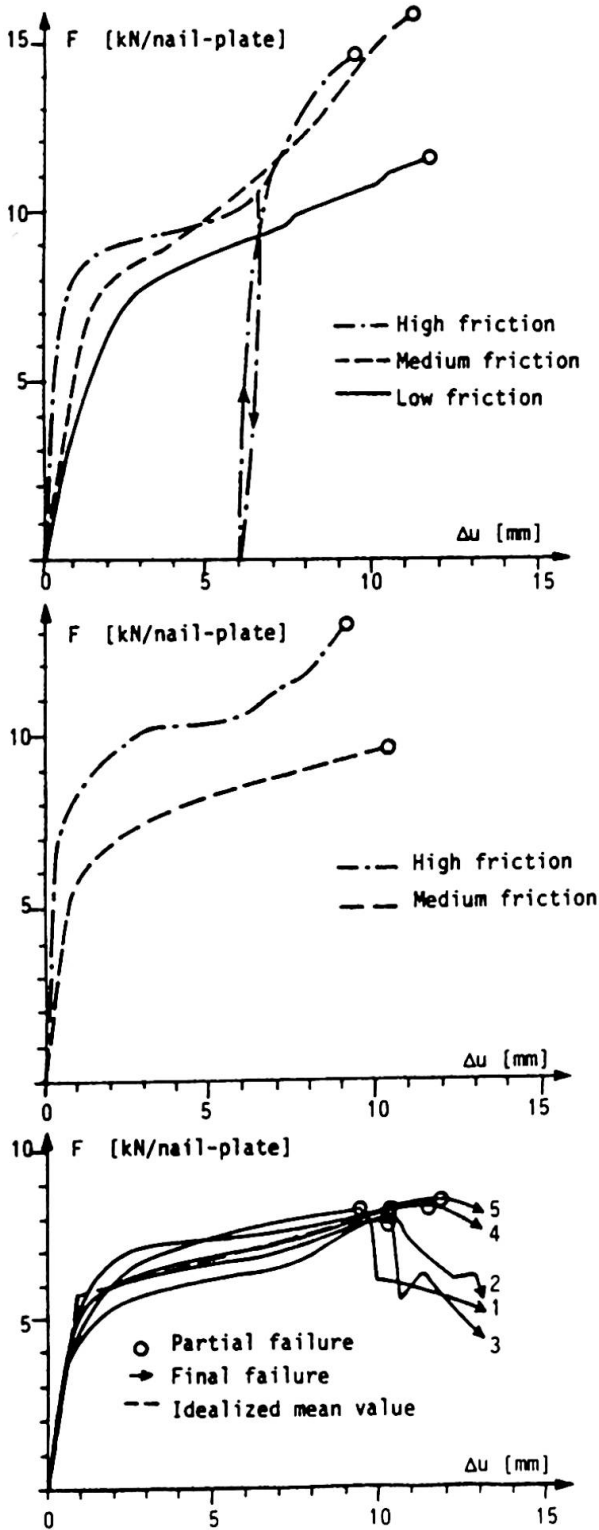

Fig. 5 Test set-up for factory-made "push-out" tests



Figs. 6,7&8 Load-slip curves for inner tests, end tests and standard design tests

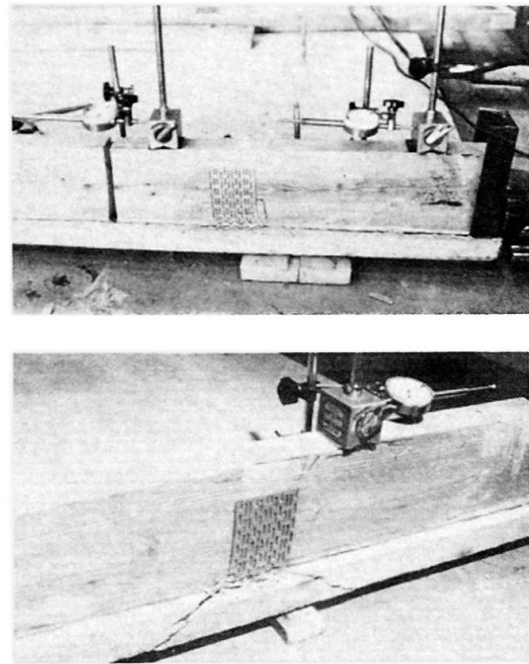

Fig. 9 Failure modes in shear in the nail-plates and cracking of the concrete edge, respectively, in the case of inner tests

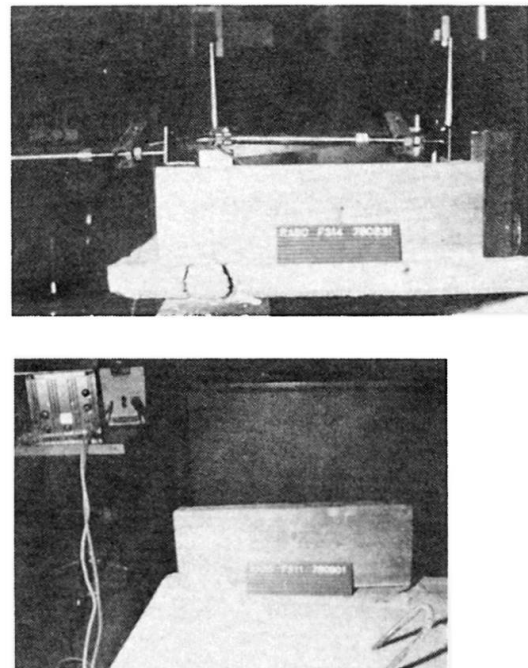

Fig. 10 Failure modes in cracking of the end of the concrete plate and shear in the nail-plates, respectively, in the case of end tests

2.2 Push-out tests on laboratory-made specimens

In order to obtain more accurate design values for the load-slip characteristics and to optimize the design of the shear connections, regular push-out tests under controlled conditions were carried out as shown in fig. 11. The quality of the reinforced concrete plates, timber studs and nail-plates was the same as that in the factory-made elements as shown in fig. 1. (The concrete plates were casted in a horizontal position in two steps on successive days. 1% CaCl was added to the concrete in order to reduce the curing time.) The friction between the timber studs and the concrete plate was eliminated by inserting lubricated pieces of sheet metal in the submaterial interface and also by the placing of a steel beam between the two concrete flanges in order to prevent the concrete flanges being pressed against the timber studs at the stage of excessive deformation in the nail-plates, cf section 2.1. A base plate placed under the centre part of the speci-

men enables the failure mode of cracking of the end or corner of the concrete plates to occur, see fig. 11. The test specimen was made symmetrica 1 in order to avoid the occurrence of eccentric forces. The test set-up is shown in fig. 12. Slip was measured at the level of the nail-plates relative to the test frame (and not relative to the concrete plates as would have been preferable). All tests were performed under deformation control.

The values of d , e and f in the standard test specimens in fig. 11 was $d = 40$ mm, $e = 25$ mm and $f = 150$ mm, which correspond to the conditions in the factory-made elements as shown in fig. 1 (the value $f = 150$ mm was chosen with regard to the results from the push-out tests on the factory-made elements). Six modifications of this standard design were made in order to evaluate the sensitivity of the cracking of the concrete plate (modifications no. 1-5), and the influence of inclined nail-plates (modification no. 6):

- 1 - The edge of the concrete plate was reinforced by placing a reinforcement bar outside the nail-plates as shown in fig. 13a.
- 2 - The edge of the concrete plate was reinforced by placing a bent steel reinforcement bar around the nail-plates as shown in fig. 13b.
- 3 - The distance between the nail-plates and the concrete edge was increased to $e = 50$ mm.
- 4 - The distance between the nail-plates and the concrete end was decreased to $f = 50$ mm.
- 5 - The embedment length of the nail-plates in the concrete plate was decreased to $d = 20$ mm.
- 6 - The part of the nail-plates embedded in the concrete plate was inclined 45 degrees as shown in fig. 13c.

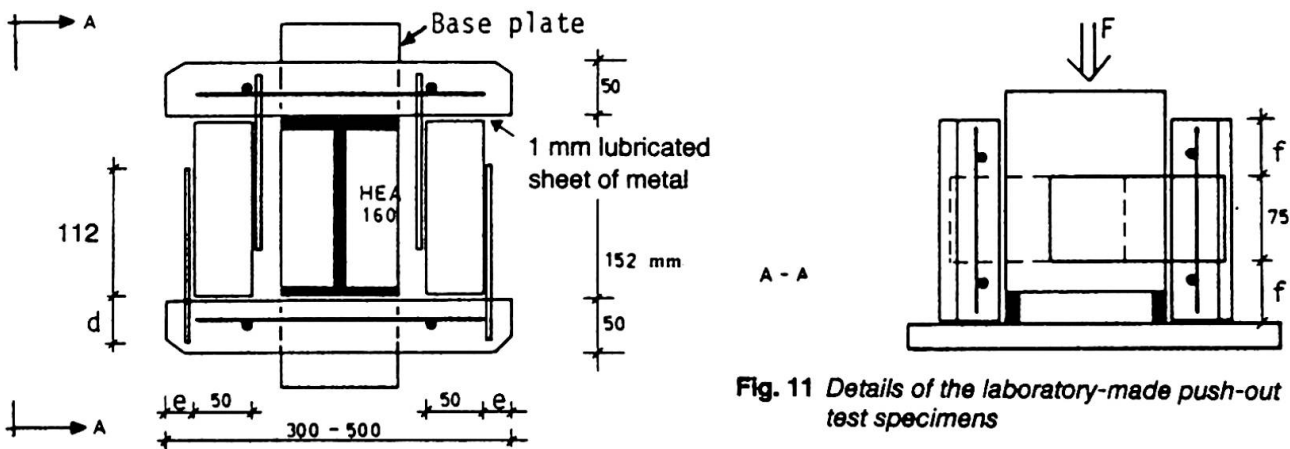

Fig. 11 Details of the laboratory-made push-out test specimens

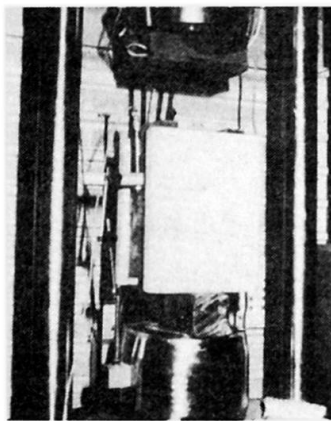

Fig. 12 Test set-up for laboratory-made push-out tests

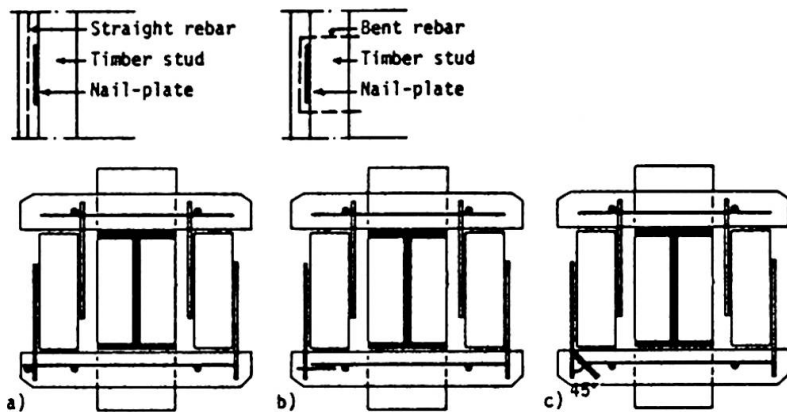

Fig. 13 a) Modified design no. 1 b) Modified design no. 2 c) Modified design no. 6

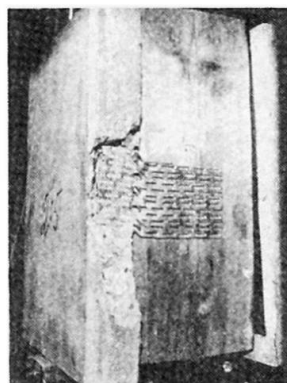

Fig. 14 Final failure by a) cracking the end of the concrete plate and b) cracking of the concrete edge for the standard design

a)

b)



The reason for testing inclined nail-plates is that the nail-plates are sometimes bent unintentionally during the fabrication of the composite elements. Five tests of each group of modification were run. The maximum load was reached when one of the nail-plates failed in shear or when cracking of the concrete plate/anchorage failure of the nail-plates occurred (called partial failure). Final failure occurred when all shear connections failed.

The experimental load-slip curves for the standard design of the shear connections are given in fig. 8. In all tests, the nail-plates were excessively deformed in shear. In the tests 1-3, some of the nail-plates were partially sheared off when the final failure by cracking of the end or corner of the concrete plate occurred, see fig. 14a. The final failure in the tests 4-5 was reached by cracking of the concrete edge, fig. 14b, but there were no nail-plate shear failures. The cracking of the concrete plate started, in both cases, at the upper edge of the nail-plates and continued through the nail-plates in the downwards direction.

The load-slip curves for the modified design of the shear connections no. 1-6 are given in figs. 15.1-15.6. In each of the figures, the idealized mean curve of the standard design of the shear connections is drawn for comparison. For the modified design no. 1, no cracking of the concrete plate occurred. The final failure was in shear in the nail-plates in all specimens, fig. 16.1&2, except no. 5 where no final failure was reached before the test was terminated. Insignificant cracks around the nail-plates were observed. As is evident from fig. 15.1, a lesser increase in the load capacity compared to that of the standard shear connection may also be noted. In the case of the modified design no. 2, the final failure was in shear in the nail-plates in all tests (fig. 16.1&2). The nail-plates were pulled out of the concrete plate about 1 mm at their upper edge. No cracking around the nail-plates was observed. The load capacity increased somewhat compared to that of the standard case, as is evident from fig. 15.2. The slip capacity at maximum load is somewhat less than that in the standard case, which might be explained by the fact that the reinforced shear connection either behaves more rigidly, or it might be due to the normal scatter in test results. The failure characteristics for the modified design no. 3 were the same as in the standard design. It is evident though, that the shear connection is somewhat more stiff than in the standard design, with a somewhat higher load and somewhat lower slip capacity as a consequence. The increase in the distance to the edge is not enough to avoid the cracking of the concrete plate, as is evident from fig. 16.3. The use of reinforcement bars is obviously much more efficient. The final failure of the modified design no. 4, was due to cracking in the end of the concrete plate, see fig. 16.4. Thus, the failure characteristics were much the same as in the standard case, but with much less slip due to early cracking in the concrete plate. The nail-plates should therefore not be placed too close to the end of the concrete plate, if not, then reinforcement bars should be placed at the edge or corner of the concrete plate. The final failure of the modified design no. 5, was in cracking of the edge of the concrete plate in the area around the nail-plate in all tests. There were fine cracks throughout the concrete plate but the splitting of the concrete plate occurred only down to the depth of the embedded nail-plate, fig. 16.5. The slip capacity was considerably decreased. The final failure of the modified design no. 6 was in shear in the nail-plates in tests 2 and 4, and in a combination of shear in the nail-plates and in the cracking of the concrete corner in the other tests (fig. 16.6). The great increase in slip capacity is due to the weak shear behaviour of the connection. This shows the advantage in making the shear stiffness of the nail-plates weaker (ductile behaviour) than the cracking resistance of the concrete plate (brittle behaviour). Obviously, there is no reason for concern as to the straightness of the nail-plates when they are embedded in the concrete plate, at least as long as the nail-plates are not bent towards the edge of the concrete plate.

3. CONCLUSIONS AND RECOMMENDATIONS

3.1 General

According to figs. 15.1 and 15.2, the design of the shear connection can be improved by using reinforcement bars along the concrete edge outside the nailplates. In this respect, straight reinforcement bars are sufficient and much easier to use. The use of reinforcement bars is both more effective and practical than increasing the edge distance, fig. 15.3.

The end distance should not be reduced as is evident from fig. 15.4. It is necessary to use additional reinforcement bars if the end distance is to be reduced. Since the shear connectors are most effective at the end of the composite element, one should ensure that reinforcement bars are placed along the edges at the corners in both directions (cf. the preceding paragraph).

The embedment length of the nail-plates should be retained as it is included in the standard design, cf. fig. 15.5. The nail-plate shear connectors will be fully effective even if they happened to be bent unintentionally during handling and fabrication of the wall element as is clear from fig. 15.6.

It is evident from the tests that the shear strength of the nail-plates should be made less than the cracking strength of the concrete plate. The load, and especially the slip capacities of the shear connection are increased and more ductile behaviour is shown when shearing in the nail-plates is the failure mode. The difference in capacity of the two failure modes is generally speaking not great when the scatter of the test results is taken into account. This indicates that the design of the connection is near optimum. As mentioned above, a slight modification can be recommended, i.e. reinforcement bars be placed along the edge of the concrete plate outside the nail-plates (modified design no. 1). This can also easily be done during the fabrication of the wall element by adjusting the position of the welded wire mesh. (Alternatively, a greater number of smaller nail-plates could be used. This alternate design must of course be evaluated by testing first). The placing of a reinforcement bar along the edge at the very end of the concrete plate can also be recommended. Again, this is easily done by adjusting the position of the welded wire fabric. By doing this, the end distance could probably be decreased from $f=150$ mm to $f=50$ mm.

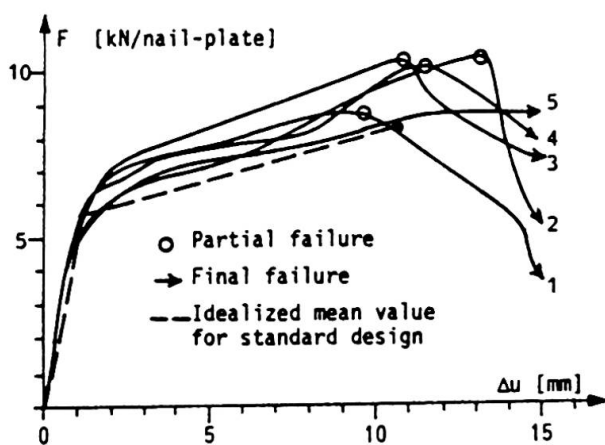

Fig. 15.1 Modified design no. 1

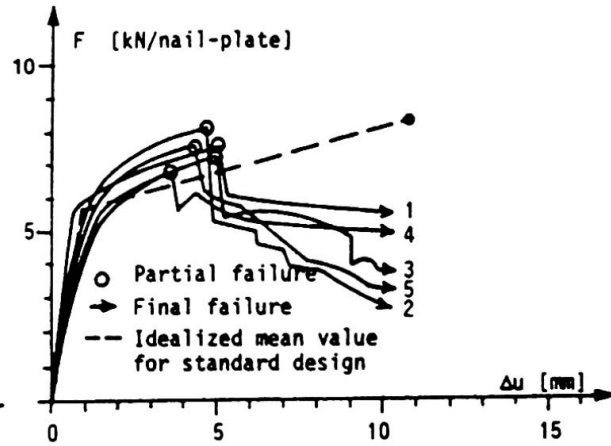

Fig. 15.4 Modified design no. 4

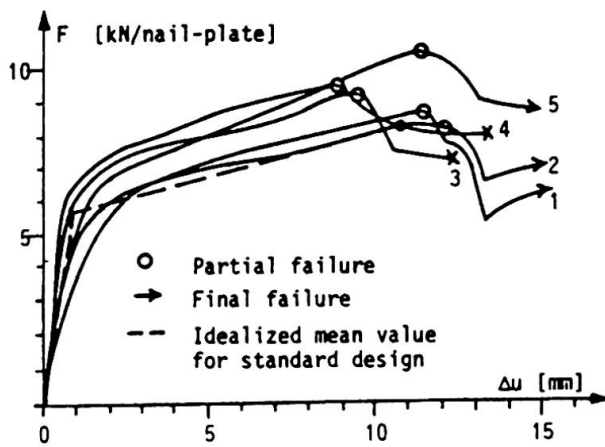

Fig. 15.2 Modified design no. 2

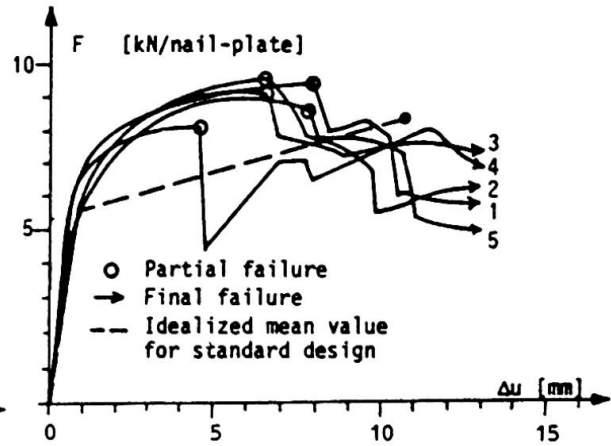

Fig. 15.5 Modified design no. 5

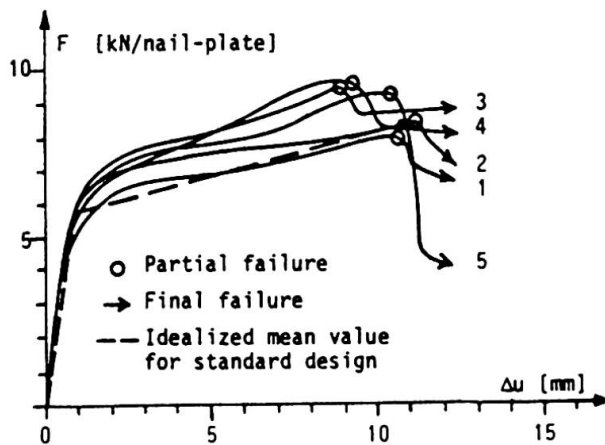

Fig. 15.3 Modified design no. 3

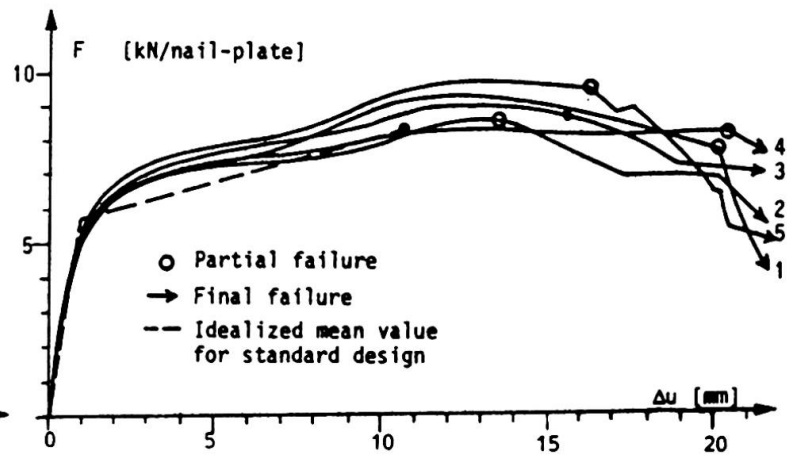

Fig. 15.6 Modified design no. 6

3.2 Design values of the nail-plate shear connectors

For design purposes, the idealized load-slip curves according to fig. 17 can be used. Three different curves are shown; the dashed-dotted line is based on the results from the factory-made specimens where friction was considered to be eliminated, the dashed line from testing the laboratory-made standard specimens, and the solid line from testing the laboratory-made specimens according to the modified design no. 1. All curves are mean values. Design values should be based on characteristic values (5% fractile for the load capacity; 50% fractile for the slip modulus. Mean values are chosen because of the positive effect of load-sharing in the nail-plates in the wall element; 5% fractile for the slip capacity). More tests should be performed for the chosen design (modified design no. 1) in order to obtain accurate design values.

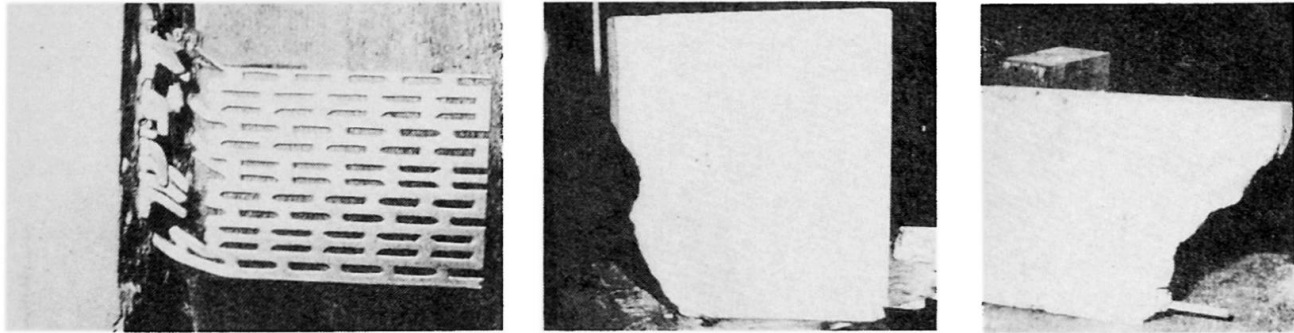

Fig. 16.1&2 Final failure in shear for no. 1&2 **Fig. 16.3** Final failure by cracking of concrete for no. 3 **Fig. 16.4** Final failure by cracking of concrete for no. 4

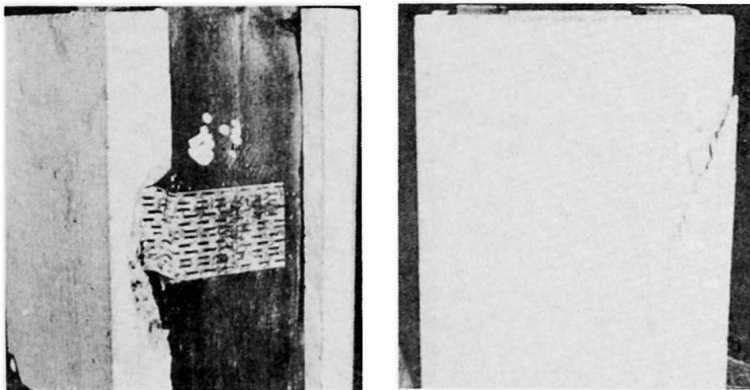

Fig. 16.5 Final failure by cracking of concrete edge for no. 5 **Fig. 16.6** Final failure in shear/cracking of concrete, no. 6

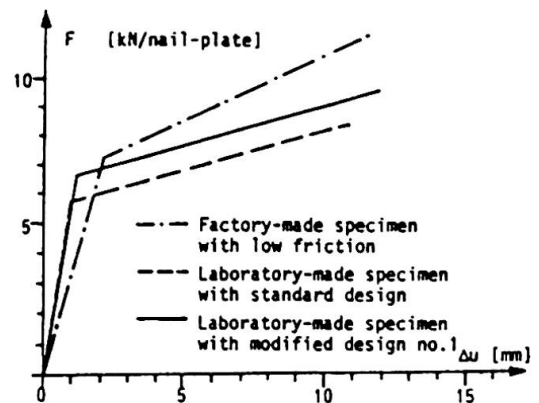

Fig. 17 Idealized load-slip curves (mean values)

It is evident from fig. 17 that the difference between the curves is not great. It is natural that the slip modulus becomes higher in the elastic range but lower in the strain-hardening range when it is based on test results obtained from regular push-out tests than on the other type of "push-out" tests. This is due to the fact that the timber studs are guided between the concrete plates, which are prevented from moving towards the timber studs by the steel beam (fig. 1.). This guiding makes the system more stiff in respect to displacement in the elastic range and prevents the build-up of friction in the strain-hardening range (cf. section 2.1).

ACKNOWLEDGEMENTS

The test were performed by Arne Rehnström and Mats Sköld at the University of Luleå, Div. of Structural Engineering.

REFERENCES

1. GIRHAMMAR, U.A.: *Composite Timber-Concrete Wall Element*. IABSE 12th Congress, Vancouver, Final Report, Sept 1984
2. UNNIKRIISHNA PILLAI, S. et.al.: *Nail Shear Connectors in Timber-Concrete Composites*. Journal Inst Eng (India) Civ Eng Div, Vol 58, No 1, pp 34-39, July 1977
3. PINCUS, G.: *Bonded Wood-Concrete T-beams*. Proc ASCE, Journal Struct Div, Vol 95, No ST 10, pp 2265-2279, Oct 1969
4. DEGERMAN, T.: *Building Element Composed of Concrete and Timber - An Investigation of Different Types of Connections (in Swedish)*. Lund Institute of Technology, Div of Struct Eng. Report TVBK-3012, 104 pp, Lund 1981
5. GIRHAMMAR, U.A.: *Tests on Rabo Wall Elements (in Swedish)*. University of Luleå, Div of Struct Eng, Research Report TULEA 1979:29, 91 pp, Luleå 1979
6. SKÖLD, M.: *Slip Tests on Nail-Plate Connections (in Swedish)*. University of Luleå, Div of Struct Eng, Examination Thesis 1980:001, 38 pp, Luleå 1980