

# An energised (postflexed) 22 metre timber-plywood box beam

Autor(en): **Gilfillan, J. Raymond / Sidwell, E. Harold**

Objektyp: **Article**

Zeitschrift: **IABSE congress report = Rapport du congrès AIPC = IVBH  
Kongressbericht**

Band (Jahr): **11 (1980)**

PDF erstellt am: **24.09.2024**

Persistenter Link: <https://doi.org/10.5169/seals-11245>

## **Nutzungsbedingungen**

Die ETH-Bibliothek ist Anbieterin der digitalisierten Zeitschriften. Sie besitzt keine Urheberrechte an den Inhalten der Zeitschriften. Die Rechte liegen in der Regel bei den Herausgebern.

Die auf der Plattform e-periodica veröffentlichten Dokumente stehen für nicht-kommerzielle Zwecke in Lehre und Forschung sowie für die private Nutzung frei zur Verfügung. Einzelne Dateien oder Ausdrucke aus diesem Angebot können zusammen mit diesen Nutzungsbedingungen und den korrekten Herkunftsbezeichnungen weitergegeben werden.

Das Veröffentlichen von Bildern in Print- und Online-Publikationen ist nur mit vorheriger Genehmigung der Rechteinhaber erlaubt. Die systematische Speicherung von Teilen des elektronischen Angebots auf anderen Servern bedarf ebenfalls des schriftlichen Einverständnisses der Rechteinhaber.

## **Haftungsausschluss**

Alle Angaben erfolgen ohne Gewähr für Vollständigkeit oder Richtigkeit. Es wird keine Haftung übernommen für Schäden durch die Verwendung von Informationen aus diesem Online-Angebot oder durch das Fehlen von Informationen. Dies gilt auch für Inhalte Dritter, die über dieses Angebot zugänglich sind.



## II

**An energised (postflexed) 22 metre timber-plywood box beam**

Poutre précontrainte de 22 m de portée avec section en caisson et âmes en contre-plaqué

Vorgespannter Holzträger mit 22 m Spannweite mit Kastenquerschnitt und Stegen aus Sperrholz

**J. RAYMOND GILFILLAN**  
Dr.  
The Queen's University of Belfast  
Belfast, Northern Ireland

**E. HAROLD SIDWELL**  
The Queen's University of Belfast  
Belfast, Northern Ireland

**SUMMARY**

A new concept for energising structures of any material and its application to timber beams is outlined. The development, design and fabrication of a 22 m span by 1.2 m deep timber-plywood box beam are described. The behaviour of the beam during stressing and uniformly distributed loading was predictable from theory previously developed. On the basis of permissible stresses, application of the technique improved the load capacity by a ratio of 2.38. Testing to refusal produced a collapse at a total uniformly distributed load of 29.7 kN/m.

**RESUME**

On présente un nouveau concept pour la précontrainte des structures formées de différents matériaux et on l'applique aux poutres en bois. On décrit les calculs et la construction d'une poutre caisson de 1,2 m de hauteur, de 22 m de portée, et dont les âmes sont en contre-plaqué. A l'aide du modèle théorique développé, on a pu prédire le comportement de la poutre, chargée uniformément et précontrainte. Si on se base sur le concept des contraintes admissibles, cette nouvelle technique permet d'augmenter la charge maximale d'un facteur de 2,38. La charge expérimentale de 29,7 kN/m a conduit à la ruine de la poutre. On décrit encore brièvement quelques autres applications possibles.

**ZUSAMMENFASSUNG**

Ein neues Konzept für das Vorspannen von Bauwerken aus beliebigen Baustoffen und dessen Anwendung auf Holzträger wird dargestellt. Die Entwicklung, der Entwurf und die Herstellung eines 1,2 m hohen kastenförmigen Trägers mit Stegen aus Sperrholz und Spannweiten von 22 m werden beschrieben. Das Verhalten des Trägers infolge der Vorspannung und infolge einer gleichmässig verteilten Belastung wurde aufgrund einer früher entwickelten Theorie rechnerisch ermittelt. Auf der Grundlage der zulässigen Spannungen erreichte man eine Erhöhung der Belastbarkeit um den Faktor 2,38. Die Bruchlast wurde experimentell zu 29,7 kN/m ermittelt. Weitere Einsatzmöglichkeiten werden kurz behandelt.



## 1. INTRODUCTION

Normal prestressed concrete in flexure depends upon either concentric or eccentric compression, the medium (agent) employed usually being tensioned prestress wire inserted into the concrete member. The zone which is subject to tension from service loads is thus given an increased tensile strength. The potential of this technique, though tremendous, is not universally applicable to structural materials since only compressive energising forces can be employed, and tension in the concrete (or other stock material) can only be produced by increasing the cable eccentricity beyond the elastic core of the section: this has its difficulties and limitations. In addition the postflexure cannot be divorced from the longitudinal postcompression, which though needed in concrete may not be required for other materials.

The new concept developed by a team of 15 researchers endeavours to remedy this deficiency by concerning itself with the theory and practice of inducing tension into materials which are subject to direct and indirect compressive service stresses. Thus complete structures or structural elements can be tensioned, reducing or mitigating compressions as desirable to complement the reduction of tensions by compression as pioneered by Freyssinet [1] and so widely employed in concrete beams. Complete ability to change the statics of a structure or structural element in accordance with ones wishes can only spring from a controlled system of energising forces of both compression and tension. The concept, theoretically possible for both determinate and indeterminate structures and applicable to any structural material has thus a very wide potential use.

Some promising results have been achieved and it would appear that the practical realisation of a valuable new structural technique is now possible.

## 2. APPLICATION TO TIMBER BEAMS

Several workers have endeavoured to justify 'concrete type energising', with eccentrically placed tensioned cables for low quality timber, by the utilisation of its relatively higher compressive strength. [2] [3] However, when materials exhibit approximately equal tensile and compressive strength properties the longitudinal compressive component of the eccentric postcompression is a disadvantage. 'The application to structural steel of the methods employed for energising concrete [4] appear to have produced in the majority of cases a cost economy more illusory than real.'

An examination of flexural strength and deflection limitation design criteria for beams indicates a need for efficient distribution of cross sectional area as in a flanged section. Such a cross section shape conflicts with the use of low quality material and eccentric energising techniques since the core limit is close to the lower flange and additional eccentricity is required to oppose dead load flexural moment. Thus, at relatively large spans, a case can be established for the use of an energising system which applies flexure to a basic element made of material with nearly equal tensile and compressive properties. Even when dead load advantages are neglected the load capacity is doubled. This energising concept depends upon inducing flexure by means of compressed wires in the upper flange and tensioned wires in the lower flange. The application and variation of flexural moment can be accomplished by the cable arrangements indicated in Fig. 1. The area between the cables may be shown to correspond to the shape of the bending moment diagram due to the energising system.

The work now described is concerned with the application of the concept and assessment of its performance in a large timber beam.

3. DEVELOPMENT, DESIGN & FABRICATION

3.1 Beam section

A timber-plywood box arrangement was adopted. The flanges were vertically laminated uniform quality Douglas fir, the webs birch plywood, Fig. 2. The relative sizes of the beam and stressing system were chosen so that, on the basis of elastic theory, permissible stresses in the timber at transfer determined the energising forces when no dead load other than self-weight was present.

3.2 Stressing system geometry

The arrangement used was similar to Fig. 1(d) except that reverse curvature was employed towards the end of the tensioned cable, Fig. 2. This simplified the operation of the end stressing units which applied force simultaneously to tensioned and compressed wires and incorporated anchoring devices.

3.3 Compressed cable form

Concern to limit force loss due to friction on compressed cables had a strong influence on energising system development. Compression is alien to the nature of steel wires but their large strength/area ratio is desirable. The cable form used, Fig. 3, consisted of steel prestress wires inside a commercial square mild steel tube. Clearance is necessary to assemble the cable, and restrained buckling of wires occurs which develops friction forces at contact with the sheath wall. This configuration was adopted following friction tests on cables 25 m long. An expression was derived [5] relating force loss to cable length and stress level; in contrast to the conventional tension case where force loss is a function of length only. Three cables were

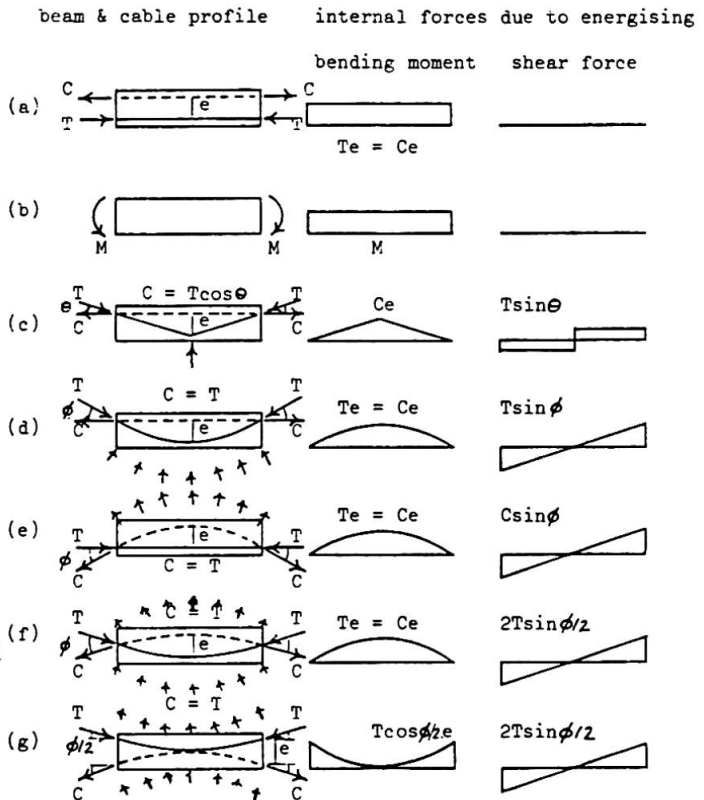

Fig. 1 Application of flexure to beams

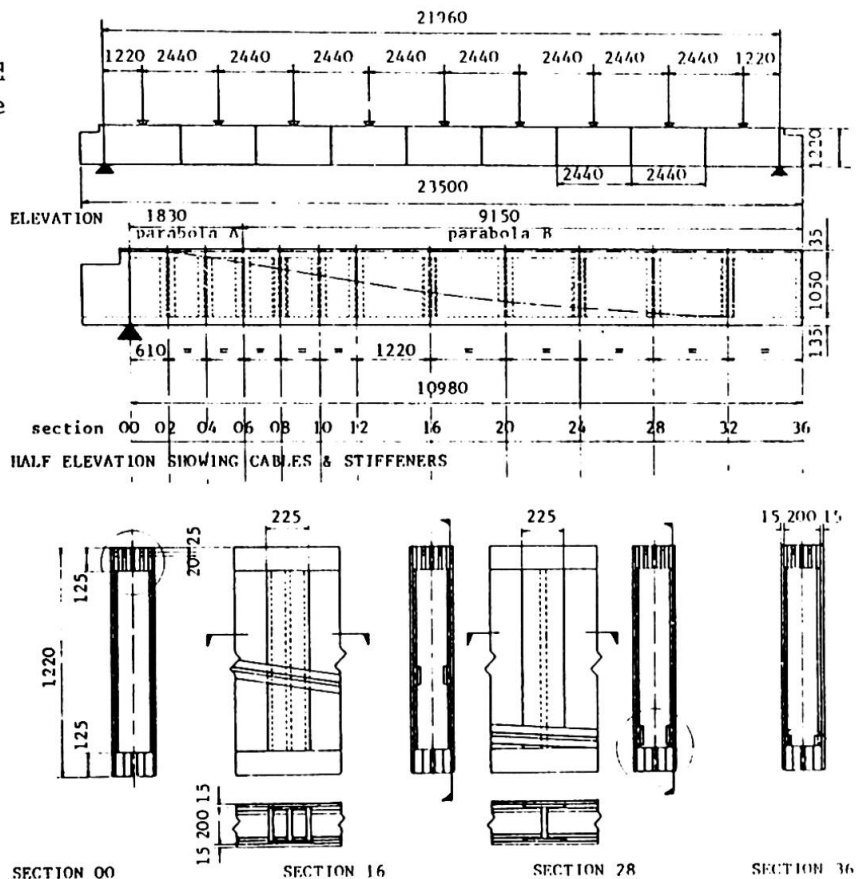

Fig. 2 General arrangement of beam and stressing system

installed in the laminations of the beam upper flange at appropriate stages during fabrication: these were balanced by two similar profiled tensioned cables, Fig. 2.

#### 4. TESTING AND INTERPRETATION OF RESULTS

The arrangement of testing rig and stabilising system is shown in Fig. 4 (plate). The behaviour of the timber beam was established and used to assess the performance of the energising system at transfer stage and under external load.

Finally the beam, in combination with fully loaded energising system, was tested to destruction. The external load was applied by nine hydraulic jacks simulating a uniform distribution. Load cells were developed to monitor forces in the compressed cables at ends and mid-span. Electrical resistance gauges were used to measure timber and plywood strains.

##### 4.1 Effects of energising system

Effects of the energising system were predictable. Moments derived from beam behaviour corresponded closely to the theoretical shape of the bending moment diagram, Fig. 5.

##### 4.2 Permissible and ultimate load

Fig. 6 shows in broken line an applied load/deflection plot at mid-span up to permissible stresses for the beam with unstressed unanchored cables. The solid line represents the plot for energised condition up to permissible stresses and beyond to failure.

For permissible loads the ratio of energised to unenergised condition was 2.38

A non violent collapse occurred at a total load, inclusive of self weight, equivalent to 29.7 kN/m. Deflection below a horizontal line was approximately 230 mm. Fig. 6 shows deflection from energised datum, ie, from upward cambered position.

The ratio of ultimate load to load at permissible stresses for the energised beam was 2.34

A method had been developed to predict collapse which depended on the characteristic strengths of Douglas fir and prestress wire [5]. The measured load was 12% less than that predicted.

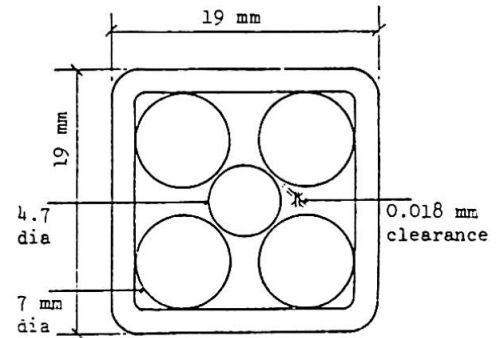

Fig. 3 Compressed cable form

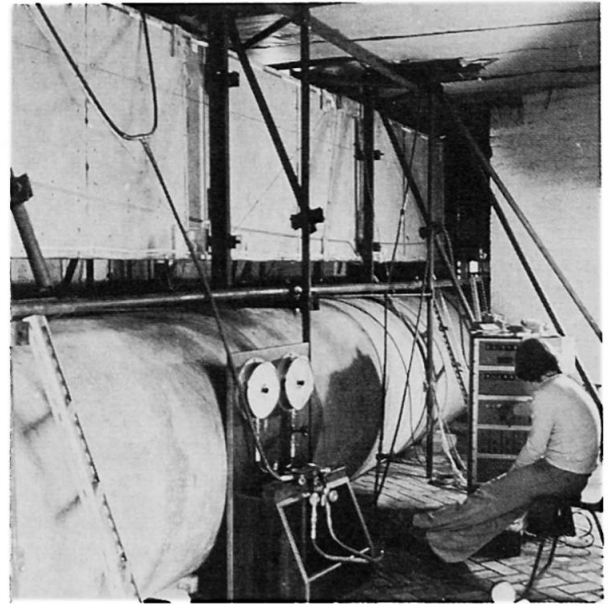

Fig. 4 (plate) Testing rig arrangement

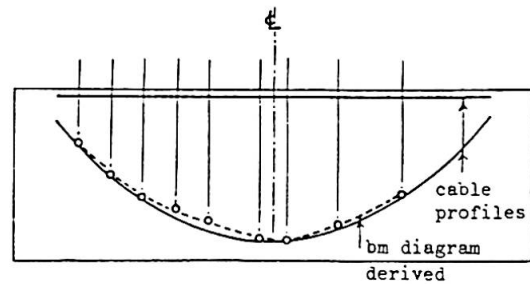

Fig. 5 Moments due to energising system

### 4.3 Friction

Maximum force loss in the compressed cables measured by load cells during energising was 9.5% from a stress of  $593 \text{ N/mm}^2$  at the ends. Since stressing was done from both ends simultaneously this represents a loss over a length of 11 m.

When an external load was applied to the beam with the energising system installed and anchored, additional cable forces were induced. Friction produced an intermediate condition between a bonded and free cable. Approaching collapse the mid-span load cells indicated a stress of  $1000 \text{ N/mm}^2$  representing an induced stress of some  $460 \text{ N/mm}^2$ .

### 5. POSSIBLE DEVELOPMENTS

In the context of increasing the span dimension, friction test results indicate that friction force loss would not be prohibitive up to spans of 50 m and beyond for wire stress levels lower than  $1000 \text{ N/mm}^2$ . By making simplifying realistic assumptions, the strength and stiffness possibilities for postflexed timber box beams manufactured from 1220 mm and 1524 mm deep standard plywood sheets have been forecast. Fig. 7 displays the span/load relationships in three pairs of graphs.

As an example a 45 m span plain timber beam 1524 mm deep with  $32250 \text{ mm}^2$  of flange is capable of permissible load of  $2.0 \text{ kN/m}$ , curve (a). By comparison a similar beam postflexed with three cables in each flange and no external load present during stressing will support  $4.0 \text{ kN/m}$ , curve (b). If dead, assumed equal to applied load as a typical practical condition acts during stressing the total permissible load capacity rises to  $8.0 \text{ kN/m}$ , curve (c). In this case the dead load is carried on the wire system the cables increasing to 8 in each flange. The application of an arbitrary deflection limitation based on deflection below a horizontal line not exceeding span/240 is shown in Fig. 7. Using this approach the critical span for the 1524 deep beam is 50.9 m.

### 6. CONCLUSIONS

The performance of the large scale energising system was very successful. It was predictably consistent and trouble free in operation. On a permissible stress basis the load carrying capacity of the timber beam was increased by a ratio of 2.38 and would have been further improved had external dead load been present.

The five wire/sheath compressed cable form proved satisfactory and could be used in groups for larger scale systems.

The investigation described sought to examine the important question as to whether the technique could be applied to the design of structural elements having the size of expected commercial applications. It is considered that this has been answered positively. Information and

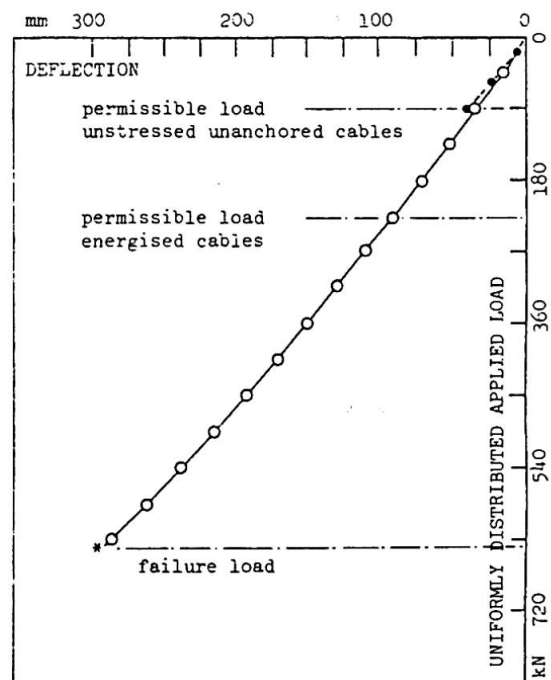

Fig. 6 Load/deflection at mid-span



experience have been gained which may be applied with confidence to further development and practical application of the technique.

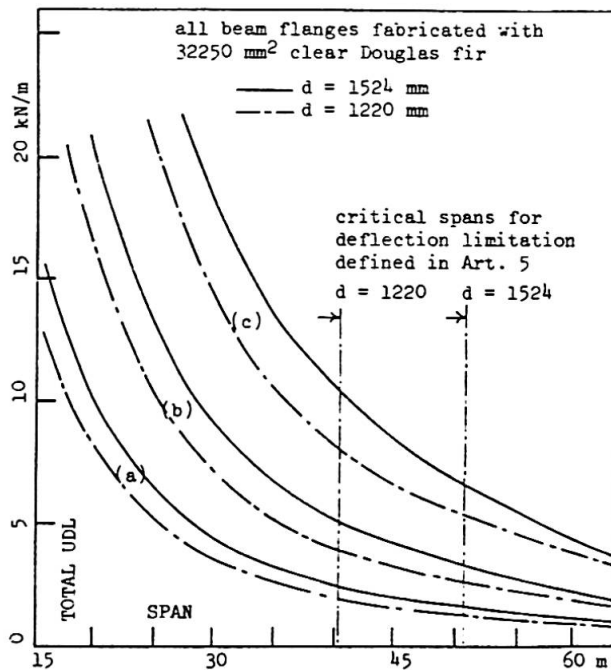

Fig. 7 Load/span relationships for simply supported timber box beams 1220 mm & 1524 mm deep subject to uniformly distributed load

- curves (a) plain timber
- curves (b) postflexed with no external load present during stressing
- curves (c) postflexed with dead load assumed equal to applied load present during stressing

#### REFERENCES

1. FREYSSINET, E. "The birth of prestressing". Travaux, 1954, trans by A.J. Harris (Cement and Concrete Association library translation no. 59) London, Cement and Concrete Association.
2. BOHANNAN, W. "Prestressing wood members". U.S. Forest Products Journal, vol. 12, no. 12, Dec. 1962. pp. 596-602.
3. LANTOS, G. "Reinforced and post-tensioned glued laminated beams under development at TRADA laboratories". Civil Engineering and Public Works Review, vol. 59, Jan. 1964. pp. 86-87.
4. NEEDHAM, F.H. "Development and use of prestressed steel flexural members". Discussion. American Society of Civil Engineers, Structural Division, vol. 95, no. ST4, April 1969. p. 1377.
5. GILFILLAN, J.R. A new prestressing concept applied to a 72 feet span timber box beam. Ph.D. thesis, Faculty of Applied Science and Technology, Queen's University, Belfast, 1978.