

The Luling Bridge

Autor(en): **Sears, Frank D.**

Objektyp: **Article**

Zeitschrift: **IABSE congress report = Rapport du congrès AIPC = IVBH
Kongressbericht**

Band (Jahr): **11 (1980)**

PDF erstellt am: **23.09.2024**

Persistenter Link: <https://doi.org/10.5169/seals-11355>

Nutzungsbedingungen

Die ETH-Bibliothek ist Anbieterin der digitalisierten Zeitschriften. Sie besitzt keine Urheberrechte an den Inhalten der Zeitschriften. Die Rechte liegen in der Regel bei den Herausgebern.

Die auf der Plattform e-periodica veröffentlichten Dokumente stehen für nicht-kommerzielle Zwecke in Lehre und Forschung sowie für die private Nutzung frei zur Verfügung. Einzelne Dateien oder Ausdrucke aus diesem Angebot können zusammen mit diesen Nutzungsbedingungen und den korrekten Herkunftsbezeichnungen weitergegeben werden.

Das Veröffentlichen von Bildern in Print- und Online-Publikationen ist nur mit vorheriger Genehmigung der Rechteinhaber erlaubt. Die systematische Speicherung von Teilen des elektronischen Angebots auf anderen Servern bedarf ebenfalls des schriftlichen Einverständnisses der Rechteinhaber.

Haftungsausschluss

Alle Angaben erfolgen ohne Gewähr für Vollständigkeit oder Richtigkeit. Es wird keine Haftung übernommen für Schäden durch die Verwendung von Informationen aus diesem Online-Angebot oder durch das Fehlen von Informationen. Dies gilt auch für Inhalte Dritter, die über dieses Angebot zugänglich sind.



VIII

The Luling Bridge

Le pont Luling

Die Luling Brücke

FRANK D. SEARS

Chief, Review and Analysis Branch
Bridge Division Federal Highway Administration
Washington, DC, USA

SUMMARY

The design and construction of the Luling bridge is the first attempt in the United States at a long-span cable-stayed bridge in structural steel. Smaller spans have been constructed in both steel and prestressed concrete and several other large types are in various stages of planning and design.

RESUME

Le pont Luling sera, aux Etats-Unis, le premier pont à haubans de grande portée, en acier. Des portées plus faibles ont déjà été réalisées en acier et en béton précontraint et d'autres ponts plus importants sont en cours de projet.

ZUSAMMENFASSUNG

Die Luling Brücke wird die erste weitgespannte Schrägseilbrücke aus Stahl in den USA sein. Kleinere Spannweiten in Stahl und Spannbeton wurden schon realisiert und mehrere grössere Projekte stehen in verschiedenen Projektierungsphasen.



THE LULING BRIDGE

The Luling bridge across the Mississippi River at New Orleans, Louisiana is the first major long-span steel cable stayed structure to be constructed in the United States. Preliminary studies by the consulting firm of Modjeski & Masters included consideration of a cantilever truss bridge, a suspension bridge and a cable stayed bridge, each for main span lengths of 2100 feet and 1600 feet, as well as cost estimates for a cantilever truss bridge and a cable stayed bridge for a main span length of 1200 feet.

Figure 1 is an artist's rendering of the final structure which was selected for construction. Design of the project was carried out under the joint venture of Modjeski and Masters and Frankland and Lienhard. The prime contractor on the project is Williams Brothers, the erection subcontractor is Melbourne Brothers, the fabricator is IHI of Kure, Japan and supervision of construction is by the Louisiana Department of Transportation.

The cable stayed span is shown in Figure 2. You will note the lack of symmetry in the end spans, occasioned by a riverward movement of pier 2 during the sinking of the caisson. The subsurface profile shown in Figure 3 will reveal the general foundation conditions under which the Pier 2 caisson was constructed. Although shown for Pier 3, the details of this caisson shown in Figure 4 will illustrate the magnitude of the problem and size of the base.

The tower shown in Figure 5 extends 350 feet above the top of pier for a total length of approximately 600 feet from founding to tower top. Cable anchorages at the tower top are shown in Figure 6 and the deck level cable anchorages are shown in Figure 7. The stay arrangement at the tower top is staggered to provide compressive seating on the bearing block. All jacking is done from the lower anchorage. You will note the encapsulation of this anchorage in a cross-girder which extends through the longitudinal girders. The cable-stays consist of from two or four strands of 1/4" diameter high tensile steel parallel wires. The number of wires per strand varies from 103 to 307 depending upon the location in the structure. The anchorages for the parallel wire strands are of the Hi-Am type with epoxy resin and steel balls. Corrosion protection for the strands is provided by encasement in polyethylene tubes which are subsequently grouted with a cement mortar. The only previous use of this type of cable-stay and anchorage system in the United States was for the Pasco-Kennewick bridge in the State of Washington.



The cross section, Figure 8, consists of two box girders supporting an orthotropic deck. The minimum deck plate thickness is 7/16 inch and the longitudinal ribs are 9" deep at 2' -2" centers. Floor beams are spaced at 15 foot centers. The steel fairing plate is only on the center span to improve the aerodynamics of the structure. It is interesting to note that wind tunnel tests were used as a design tool rather than an after the fact investigation. During design, wind tunnel studies were conducted on six different cross sectional configurations so as to select the proper aerodynamic shape.

Figure 9 indicates that construction is proceeding nicely to date. The approaches and towers are now complete and you will note in Figure 10 the 250 ton crane built especially for this project. The orthotropic deck configuration, as can be seen from Figure 11, extends one approach span beyond each anchor span, and the contractor has elected to build the west anchor span on falsework rather than by balanced cantilever in each direction from pier 2. After the anchor span is completed to pier 2, construction of the west half of the main span will begin, utilizing the stays and weight of the anchor span as necessary to construct the west half of the center portion of the bridge without falsework. The east anchor span and the east half of the center span will be erected by balanced cantilever from pier 3. Construction of the cross section is done in segments across the roadway width. You will note the cross girder in the lower left of Figure 12.

Keeping in mind that the design of the structure began in the early 1970's, it is interesting to speculate whether the configuration of this structure would be maintained if the design were to be done today. Too few stays are spaced too far apart at the deck level. This resulted in large forces at the cable-stay anchorages that had to be distributed by large transverse cross-girders, which are fracture critical. A larger number of stays spaced closer together would reduce the size of the stays and thus the anchorage forces which would in turn reduce the size and complexity of the anchorage detail as well as the cross-girder. By virtue of the closer spacing of the stays, the depth of the girder could be reduced leading to economy in steel weight. In addition, the length and weight of deck segments would be reduced which would improve erection by eliminating the use of temporary stays.

Total cost of the five span main structure is \$84.3 million, which consists of \$42.5 million for the substructure and \$41.8 million for the superstructure. Total square foot cost for the superstructure, is \$185.70. Structural metalwork in the superstructure, exclusive of the cable-stays is approximately \$150.00 per square foot. Cost of the cable-stays was \$2.06 million or \$9.15 per sq. ft. based on the five span superstructure. Cable-stay cost per pound is \$1.90 and structural steel was \$0.91 per lb.

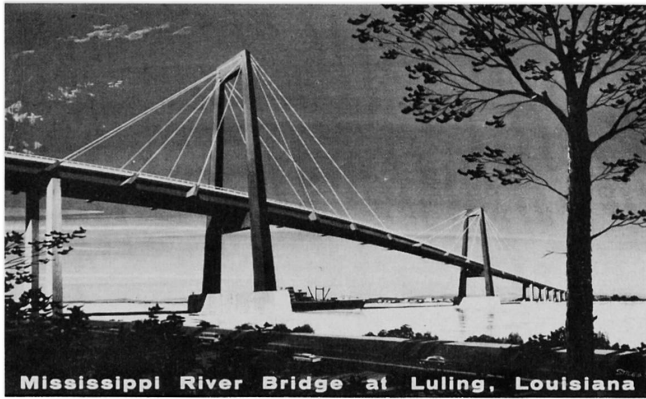

Mississippi River Bridge at Luling, Louisiana

Fig. 1

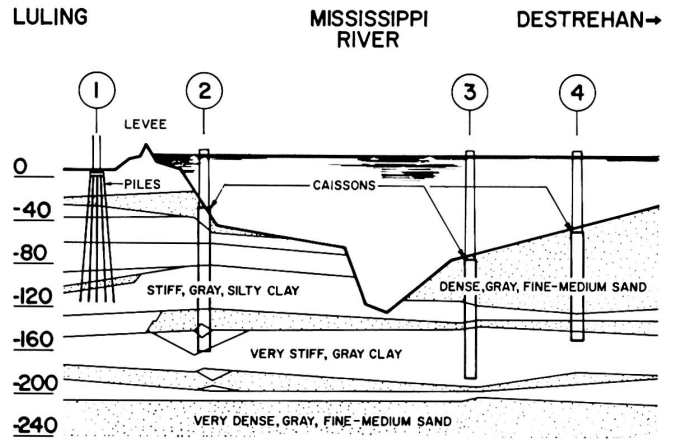

Fig. 3

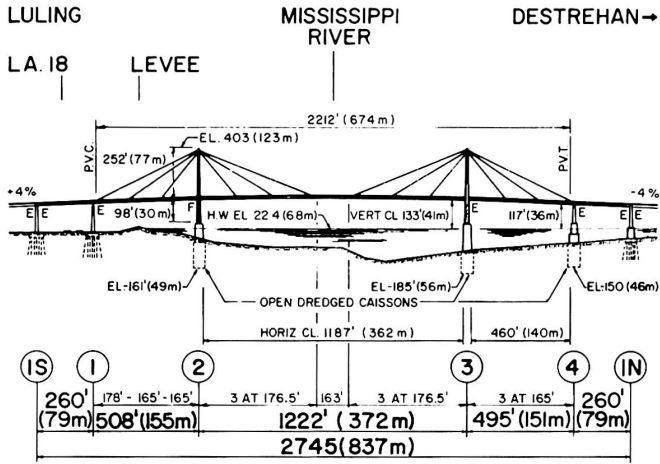

Fig. 2

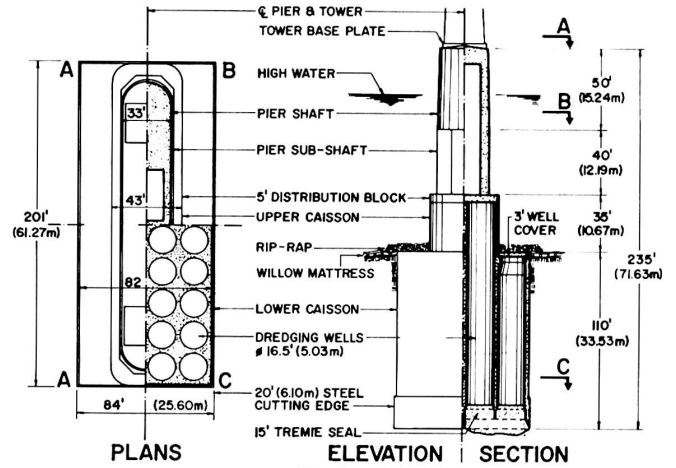

Fig. 4

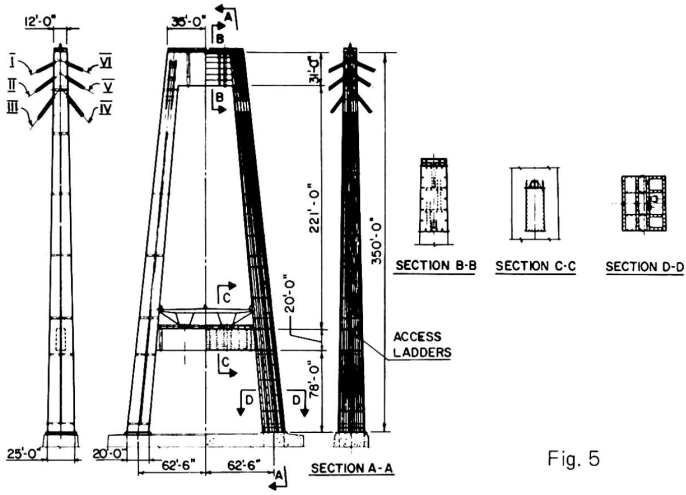

Fig. 5

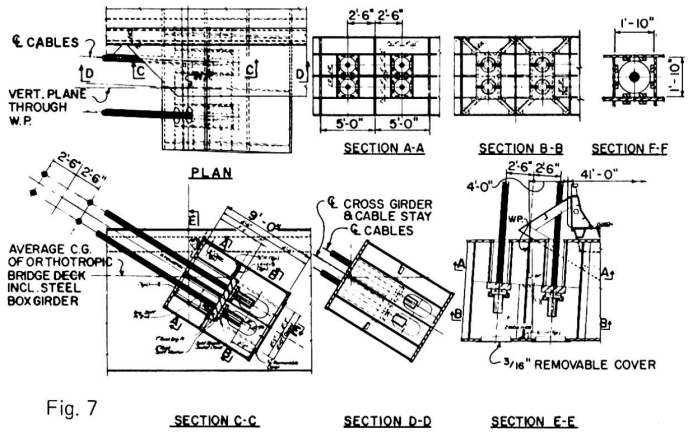

Fig. 7

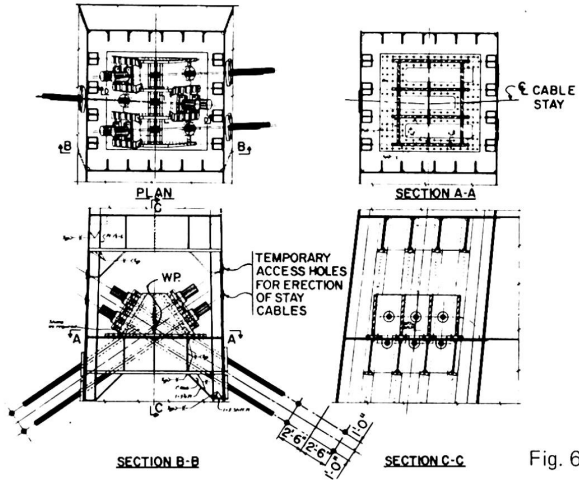

Fig. 6

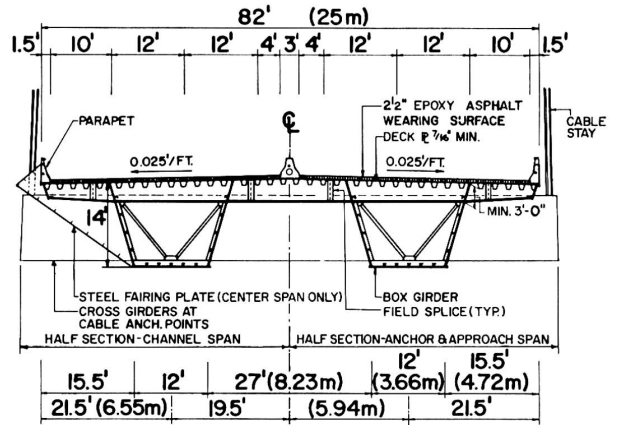

Fig. 8

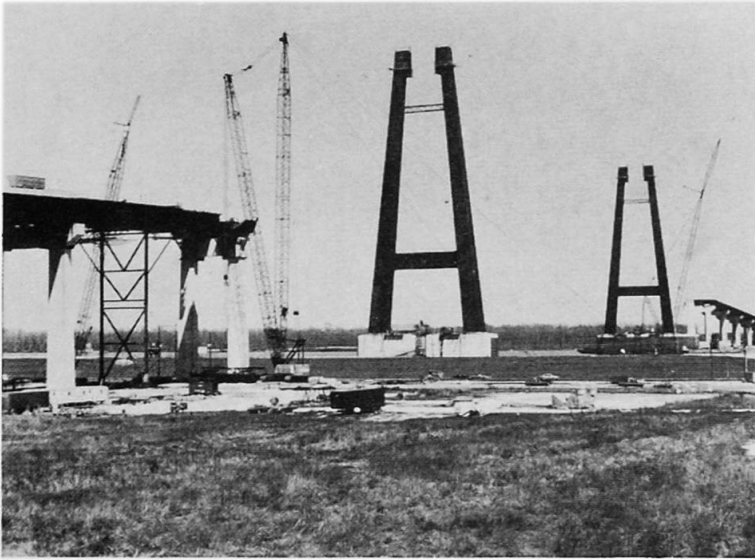

Fig. 9



Fig. 10



Fig. 11

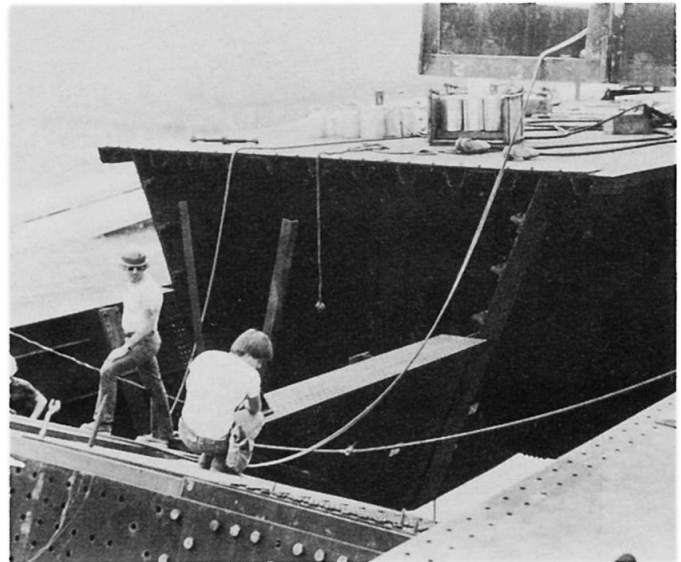

Fig. 12