

Theme IVa: Offshore structures

Objektyp: **Group**

Zeitschrift: **IABSE congress report = Rapport du congrès AIPC = IVBH
Kongressbericht**

Band (Jahr): **10 (1976)**

PDF erstellt am: **23.09.2024**

Nutzungsbedingungen

Die ETH-Bibliothek ist Anbieterin der digitalisierten Zeitschriften. Sie besitzt keine Urheberrechte an den Inhalten der Zeitschriften. Die Rechte liegen in der Regel bei den Herausgebern.

Die auf der Plattform e-periodica veröffentlichten Dokumente stehen für nicht-kommerzielle Zwecke in Lehre und Forschung sowie für die private Nutzung frei zur Verfügung. Einzelne Dateien oder Ausdrucke aus diesem Angebot können zusammen mit diesen Nutzungsbedingungen und den korrekten Herkunftsbezeichnungen weitergegeben werden.

Das Veröffentlichen von Bildern in Print- und Online-Publikationen ist nur mit vorheriger Genehmigung der Rechteinhaber erlaubt. Die systematische Speicherung von Teilen des elektronischen Angebots auf anderen Servern bedarf ebenfalls des schriftlichen Einverständnisses der Rechteinhaber.

Haftungsausschluss

Alle Angaben erfolgen ohne Gewähr für Vollständigkeit oder Richtigkeit. Es wird keine Haftung übernommen für Schäden durch die Verwendung von Informationen aus diesem Online-Angebot oder durch das Fehlen von Informationen. Dies gilt auch für Inhalte Dritter, die über dieses Angebot zugänglich sind.

IVa

Comments by the Author of the Introductory Report

Remarques de l'auteur du rapport introductif

Bemerkungen des Verfassers des Einführungsberichtes

J.G. BOUWKAMP

President

Offshore Development Engineering, Inc.

Berkeley, California U.S.A.

Offshore Structures

Mr. Chairman, Ladies and Gentlemen,

The contributions to the theme, *Offshore Structures*, as published in the Preliminary Report, covered not only general design aspects of both steel and concrete structures, but also focused on at least one of the more significant design details, namely tubular joints.

The contributions by Roret and Ciolina on steel structures, and Gerbault and Xercavins on concrete structures, give an up-to-date general review of several structural systems which have been developed for the exploration and production of hydrocarbon deposits in offshore regions. Unfortunately, space limitations prevented discussion in depth of detailed technical problems associated with the design, construction and installation of these structural systems. Most problems are related to the dynamic behavior of the structures under the effects of waves, currents, wind, ice and earthquakes, and require full consideration of the soil-foundation-structure-fluid interaction. For instance, soil conditions are a major factor in evaluating both the short- and long-term dynamic response of gravity platforms under cyclic, wave-induced loads. Equally significant is the dynamic behavior of steel tubular trusses and their connections under such load conditions. In addition to the response to extreme waves and winds, earthquakes are another important factor. One of the most significant elements in the structural design of steel tubular trussed towers is the tubular joint. It was, therefore, particularly fortunate that the contributions of Kurobane, et al, and Okumura, et al, were addressed to the performance of tubular joints. In light of my own experience in this subject, I would like to focus on this particular aspect in greater depth. However, first I would like to note the contributions by Shimada and Yamamoto, and Coulard. Although the authors focused on harbor and coastal structures, rather than offshore structures, they do draw attention to the fact that offshore developments are not complete without the necessary onshore facilities for equipment maintenance and transfer of oil and gas to shore.

The history of tubular joint fatigue research goes back almost twenty years. At that time the primary focus was directed towards developing joint design criteria which would assure the overall structural integrity of a tower structure under extreme wave and wind conditions. (1,2,3,4) These criteria reflected the environmental conditions in the relatively shallow waters of the Gulf of Mexico where extreme waves were the critical design condition. The resulting design criteria based on the "punching shear" strength concept resulted in joints which were capable of withstanding these extreme load conditions, even when applied for a limited number of loading cycles. Consequently, in the initial studies, consideration was given to the low-cycle fatigue resistance of these joints. The design was typically a jacket-type multi-legged trussed tower with tubular members. Joints normally consisted of 42 to 48 inch diameter column members and tubular brace members of approximately 16 to 24 inches in diameter. The design of these joints was typically based on extreme load conditions which would produce a nominal stress reversal in the diagonal members of 28 ksi.

These studies readily indicated that the flexibility of the column member wall was the main source of stress concentrations and consequently resulted in early fatigue failure; "hot spot" stresses were identified. In order to stiffen the column wall, one considered increasing the column wall thickness, using external ring stiffeners or in-plane gusset plates, or possibly, overlapping and interwelding the web members. (5,6,7,8,9) Comparative studies clearly indicated that a joint with a thickened column wall and non-overlapping web or branch members was superior from the point of view of strength and low-cycle fatigue resistance. These initial studies successfully guided the design of tubular joints under these particular environmental conditions (extreme waves). However, these design rules became inadequate where offshore developments moved into more hostile regions. Not only the extreme sea state, but also the repeated cyclic low-forcing wave effects became significant design considerations. Hence, a more general approach to fatigue and cumulative fatigue damage became necessary.

Comparative studies of the type noted before could no longer provide sufficient input to determine the structural response resulting from the broad load spectrum which now had to be considered in design. Consequently, other theories and their applicability had to be evaluated. Miner's linear cumulative fatigue damage hypothesis was used in establishing the effect of cumulative fatigue damage. Equally important, however, was the need of determining the stress versus number-of-cycles, or "S-N", curves necessary to determine the ultimate fatigue resistance for given stress levels. Considering the complex environmental conditions and material response, different theories have been considered and their application to tubular joint design evaluated. In this respect, a linear-elastic fracture mechanics approach to determine theoretical S-N curves has been found to yield a satisfactory correlation between theoretically predicted and experimentally observed fatigue crack behavior. (10)

In principle, this type of approach is needed in order to develop design criteria for the many different systems which are designed to operate in the often hostile offshore regions now consid-

ered for development. The severity of the environmental loads requires a new approach to tubular joint design considering both joint strength, joint stiffness and fatigue resistance. There is no doubt that solutions can be obtained. However, it will require the most advanced integrated approach of loading methodologies, computer modeling techniques, analysis, fabrication and material science. Not only material properties affecting the ultimate response are significant, but also the prediction of the highly complex dynamic response of offshore structures, both stationary and floating, steel or concrete. In that instance, the combined effects of waves, currents, winds, soil conditions and earthquake loadings should be fully considered. Only a highly advanced approach in analyzing the anticipated performance will provide the basis for a satisfactory design.

I noted in the last paragraph, concrete structures as well. While I did address myself to the fatigue aspect of tubular joints and the overall design requirements of steel platforms, concrete or pre-stressed concrete structures require an equally rigorous design approach. Consequently, the engineer's total understanding of the many environmental and structural performance aspects in every phase of design, is essential. Extending knowledge and performance data to structures similar in concept, but located in different environments, does require the utmost of engineering attention in order to prevent the potentially catastrophic outcome of extending the "present state-of-the-art" to new regions without full consideration of all factors involved. In that respect, I hope that the subsequent discussions and future contributions published by the IABSE on this subject may aid the profession in a field which, because of the short history and engineering complexity, requires our fullest attention.

REFERENCES

1. "API Recommended Practice for Planning, Designing and Constructing Fixed Offshore Platforms", API RP 2A.
2. Carter, R.M.; Marshall, P.W.; Thomas, P.D.; and Swanson, T.M.; Offshore Technology Conference, Paper No. 1043, Houston, Texas, May 1969.
3. Bouwkamp, J.G.: "Concept of Tubular-Joint Design", Journal Structural Division, ASCE, Vol. 90, No. ST2, Proc. Paper 3864, April 1964, PP.77-101.
4. Bouwkamp, J.G.: "Recent Trends in Research on Tubular Connections", Jour. Pet. Tech., November, 1966, pp.1491-1499.
5. Bouwkamp, J.G.: "Tubular Joints Under Static and Alternating Loads", Report No. 66-15, Structures and Materials Research, Structural Engineering Laboratory, University of California, Berkeley, California, June 1966.
6. Bouwkamp, J.G.: "Tubular Joints Under Slow-cycle Alternating Loads", Proceedings of the International Symposium on the Effects of Repeated Loading of Materials and Structures, RILEM, Mexico City, Vol. VI, September 1966, pp.1-31.
7. Bouwkamp, J.G.; Stephen, R.M.; "Tubular Joints Under Alternating

- Loads" Report No. 67-29, Structures and Material Research, Structural Engineering Laboratory, University of California, Berkeley, California, November 1967.
8. Bouwkamp, J.G.: "Tubular Joints Under Alternating Loads", Proceedings of the Third Conference on Dimensioning, Hungarian Academy of Sciences, Budapest, Hungary, 1968, pp.49-59.
 9. Bouwkamp, J.G.; Stephen, R.M.; "Tubular Joints Under Alternating Loads, Phase II, Part 2", Report No. 70-4, Structures and Materials Research, Structural Engineering Laboratory, University of California, Berkeley, California, March 1970.
 10. Becker, James M.; Gerberich, William W.; Bouwkamp, Jack G.; "Fatigue Failure of Welded Tubular Joints", Journal of Structural Division, ASCE, Vol. 98, No. ST1, Proc. Paper 8624, January 1972, pp.37-59.

Ultimate Strength Design Formulae for Simple Tubular Joints

Formules du calcul à la résistance limite pour les noeuds simples de profilés circulaires

Formeln für die Ermittlung der Traglast von einfachen Knotenpunkten in Rohrprofilen

YOSHIAKI KUROBANE
Professor

YUJI MAKINO
Instructor
Kumamoto University
Kumamoto, Japan

YOSHIYUKI MITSUI
Associate Professor

1. INTRODUCTION

One of the Committees in the Architectural Institute of Japan is carrying out revision of the "Specification for Design of Tubular Structures in Steel" that was first published in 1962. Although the Specification is applicable to the building structure, it may provide a good deal of information for the design of offshore structures of tubular members.

This report discusses about the experimental grounds of those provisions for the design of the tubular X, T, Y and K-joints for static loadings which are presently under deliberation in the Committee. The provisions are based on the ultimate strength formulae that were selected for such use from the results of a series of regression analyses of the test data obtained in Japan and the U.S.A. since 1963. The derivation of the formulae is described in detail in Reference [1].

All the existing ultimate strength formulae for these joints have been subjected to two questions as follows:

1. Most of the existing ultimate strength formulae tend to overemphasize the strength of the T, Y and K-joints when the diameter to thickness ratio of the chord (D/T) becomes greater than about 50.
2. The strength of the K-joint increases as the two braces intersect and then overlap with each other. This behavior is not adequately taken into account in the existing formulae.

To overcome these difficulties the reanalyses of the test data were carried out as a continuation of the past studies by the authors and their colleagues[2],[3].

The strength of the tubular joints under static loads is an influencing factor in determining the design of any tubular structure and yet it still covers some areas that are not fully understood at the present stage, which may be clear from the later discussions in this report. In this regards the authors wish to welcome any comment on the proposals presented in this report.

2. DEFINITION OF ULTIMATE STRENGTH

The ultimate strength referred herein is the maximum axial compressive force applied at the brace ends when a joint fails as a result of excessive local bending deflections of the chord walls. The strength of a joint that fails owing to

* Additional test data are now being gathered from Europe through the activity of the Subcommittee XV-E of the IIW.

failures in a member, such as fracture of the tension brace or local instability of the compression brace, is outside the scope of the present definition of the ultimate strength of the joint.

The local failure of the chord walls occurs also at the points where tension braces are attached. The final rupture of these joints is controlled by cracking of the chord and/or brace walls at the toes of the brace to chord welds. The joints that fail in this manner always attain a far greater

strength than that in the former case where the braces are under compression. The ultimate strength data for the joints under tension should therefore be treated separately and are excluded from the regression analyses in Reference [1].

According to the past tests, most tubular joints reached the maximum load after full plastic deflections of the chord walls were produced at the local portions where the braces were attached, and then unloading took place. A typical load-deflection curve of such joints is shown by the curve 1 in Fig. 1. In some joints, however, the overall stiffness increased again after they sustained full plastic deformations of the chord walls and eventually carried a greater load than the first maximum load. The load-deflection curves of the latter type are shown by the curves 2 and 3 in Fig. 1. The ultimate strengths used for the analyses were the first maximum loads that were attained by the joints after sufficient areas of the chord walls yielded.

K-joints often fail in a combination of various failure modes depending upon the dimensions of the joints. Even though the final failure of a K-joint was governed by one of the other modes than the excessive local deflections of the chord walls, the ultimate strength of the joint was included in the data so far as the joint sustained full plastic deflections of the chord walls under the compression brace at the maximum load.

3. PROCEDURE OF REGRESSION ANALYSIS

The multiple regression analyses were carried out to develop the best-fit equations of the ultimate strengths of the joints. In the process of building a mathematical model for a prediction equation, it was first assumed that the joint was able to be replaced by a simple and fictitious structure of which ultimate strength would represent the ultimate strength of the actual joint.

Such a simplified model structure is a ring with an effective width B_e . The ring has the same diameter D , thickness T and yield stress σ_y as those of the actual joint and is subjected to concentrated forces acting at d distant points, where d is the outer diameter of the brace. These concentrated forces represent the axial compressive force P in the brace.

Table 1 Proposed Ultimate Strength Formulae

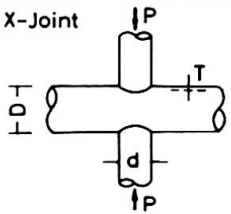
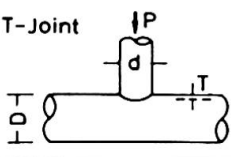
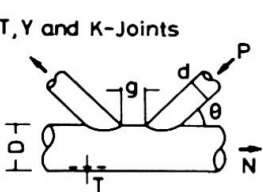
Type of Joints	Predicted Ultimate Strength, P_u
X-Joint 	$P_u = \frac{6.57}{1 - 0.810 d/D} \sigma_y T^2 \quad (a)$
T-Joint 	$P_u = 6.43 \left[1 + 4.60 \left(\frac{d}{D} \right)^2 \right] \sigma_y T^2 \quad (b)$
T, Y and K-Joints  $\bar{N} = N / \sigma_y A$ $A = \pi (D - T) T$	$P_u = 2.11 \left(1 + 12.1 \frac{d}{D} \right) f_g f_\theta f_{\bar{N}} \sigma_y T^2 \quad (c)$ $f_g = 1 + 3.88 \left(1 - 20.9 \frac{T}{D} \right) \left(1 - 0.530 \frac{d}{D} \right) \cdot \left(1 + \frac{2}{\pi} \tan^{-1} \left(0.237 - 0.183 \frac{g}{T} \right) \right),$ <p style="text-align: center;">but not less than 1.0</p> $f_\theta = (1 - 0.167 \cos \theta + 0.049 \cos^2 \theta) / \sin \theta$ $f_{\bar{N}} = 1 + 0.262 \bar{N} - 0.391 \bar{N}^2$ <p style="text-align: center;">(\bar{N} : positive for tension)</p>

According to the simple plastic theory, the collapse load of the ring P_u is given by the equation,

$$P_u = \frac{Be}{a} f_0\left(\frac{d}{D}\right) \sigma_y T^2 \quad (1)$$

where a is the mean radius of the chord. Be and $f_0(d/D)$ are functions of geometrical parameters of the joint and vary with the type of the joint.

Therefore, the model may be written in the form,

$$P_u = f_0\left(\frac{d}{D}\right) f_1\left(\frac{d}{D}, \frac{T}{D}, \frac{g}{T}, \theta, \bar{N}\right) \sigma_y T^2 \epsilon \quad (2)$$

in which P_u is the ultimate strength of the joint, g is the clear space (gap) between the two braces, θ is the angle of intersection between the compression brace and the chord and \bar{N} is the dimensionless axial stress in the chord (See Table 1). ϵ is the error term, which was assumed to be multiplicative rather than additive because the model (2) consists of multiplicative terms of the influencing factors each of which has a certain physical meaning [1]. It is assumed here that errors $\ln(\epsilon)$ are independent random variables with mean zero.

Since the postulated model was nonlinear in the parameters, the linearization and iterative techniques were exercised to fit the model by the method of least squares [4]. A series of such analyses were performed with several alternative models for the functions f_0 and f_1 of Eq. 2. The resultant regression equations were compared on the basis of the "multiple correlation coefficient R^2 ". The final selection of an equation was made such that the selected equation would explain the variation of the ultimate strength data better (attain a larger R^2) with less predicting variables.

In Reference [1] are shown all the data used for the analyses and also the reference sources of them. An effort was made to utilize as far as possible measured values rather than nominal values for the independent variables. Although the yield stress in the circumferential direction may be more meaningful in this model, such yield stress is not usually measured in most experimental works. σ_y s adopted herein are the longitudinal yield stresses measured on tensile coupons cut from the as-rolled chord materials.

4. RESULTS OF ANALYSES AND DISCUSSIONS

The three equations shown in Table 1 were selected as the ultimate strength prediction equations for the tubular X, T, Y and K-joints. Eq. c is applicable to any of the T, Y and K-joints, where g is infinitely large in the T and Y-joints and becomes negative when the braces overlap in the K-joint. R^2 was of 92%, 95% and 91% in Eqs. a, b and c, respectively.

The residuals provided by Eq. c are plotted overall in a form of a frequency histogram (Fig. 2). It appears that the residuals follow a normal distribution. According to a chi-square goodness of fit test this assumption of normality was found to be acceptable at the 0.05 level of significance. From this it may not be unreasonable to assume that, if the model is correct, errors $\ln(\epsilon)$ are normally distributed.

Since the models are nonlinear, statistical tests that are true for the linear case do not apply. However, since the number of observations n is large, the 95% confidence limits for an

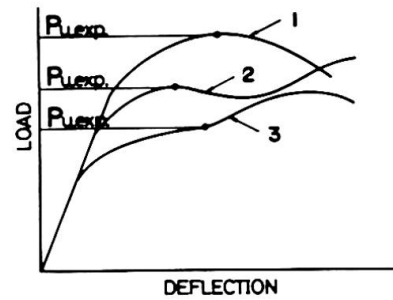

Fig. 1 Examples of Load-Deflection Curves

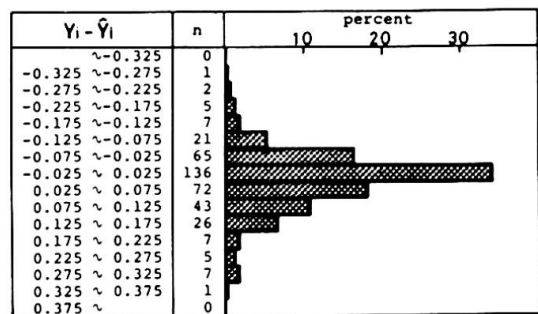

Fig. 2 Histogram of Residuals

individual predicted value are approximately given by

$$P_u \cdot e^{\pm 2s} \tag{3}$$

where s is an estimate of standard deviation and is approximately obtained by the equation,

$$s = \sqrt{\frac{(\text{residual sum of squares})}{n - p}}$$

in which p is the number of parameters in the regression equation. The above statement is valid only when the errors $\ln(\epsilon)$ are normally distributed.

The predicted mean value P_u and the approximate 95% confidence limits according to (3) are compared with the test results " $P_{u,exp}$ " in Figs. 3 through 6. These plots indicate no strong abnormality in the residuals and the present regression analyses would not appear to be invalidated.

It is important to note that the formulae in Table 1 are applicable only within the ranges of variation of the predicting variables. Figs. 8, 9 and 10 illustrate how the predicting variables varied in the test data.

The Japanese Specification referred to earlier tentatively assumes a factor of safety of 2 on the predicted ultimate strengths of the X, T, Y and K-joints. The allowable force may be increased 50% above $P_u/2$ when the joint is under combined permanent and temporary loadings. This safety factor appeared to be conservative from Figs. 3 through 6. In order to calculate a probability of failure for a joint, however, it is necessary to know probability distributions of loads and the yield stress of the materials.

5. COMPARISON OF PROPOSED FORMULAE WITH EXISTING FORMULAE

The proposed formulae and the test results are compared with the formulae recommended in the AWS and DNV-Codes [5],[6] in Figs. 3 through 6 where factors of safety are not taken into account. The DNV-formula agrees well with Eq. a as well as with the test results for X-joints. However, both the AWS and DNV-formulae are not necessarily consistent with the formulae b and c nor with the test results for T, Y and

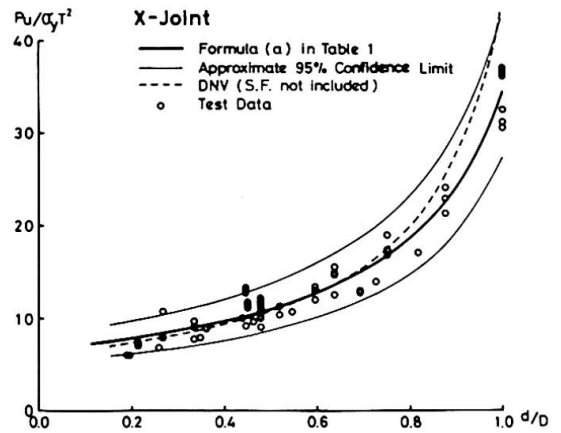

Fig. 3 Predicted Ultimate Strengths and Test Results

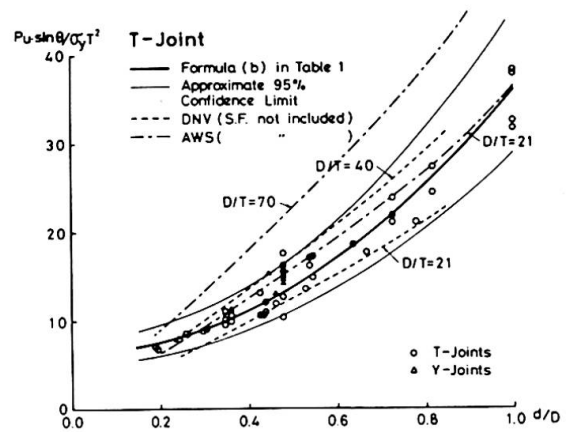

Fig. 4 Predicted Ultimate Strengths and Test results for T and Y-Joints

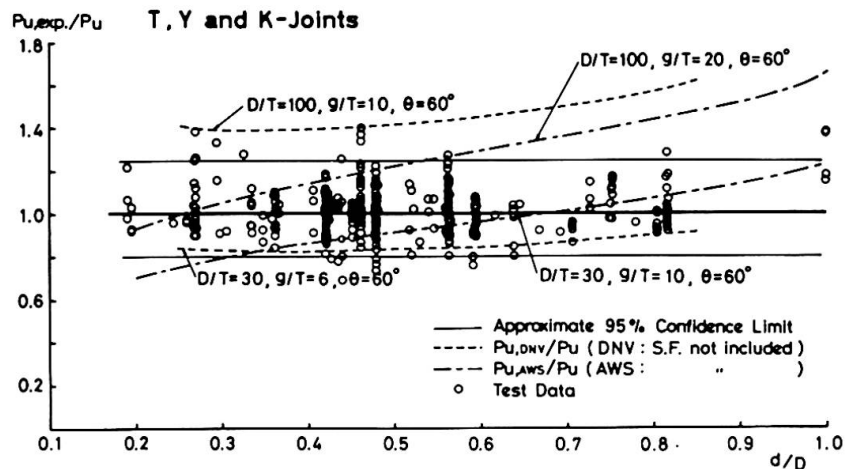

Fig. 5 Ultimate Strengths of T, Y and K-Joints: Comparisons between Formula c, AWS and DNV Formulae and Test Data

k-joints. In most cases, the AWS and DNV-formulae are risky when $D/T=100$ and are too conservative when g/T is less than about 8. Response of the AWS formula to a variable d/D looks to be different from what is observed in the test results for K-joints. Both the formulae are generally applicable to the T and Y-joints and the K-joints with extended braces, when D/T is less than 40.

Another comparison is made between Eq. c and the formula by Okumura et al [7] in Fig. 7. The ultimate strengths of T, Y and K-joints predicted by the Okumura's formula are scattered between the two dashed lines in the figure (when $\theta=60^\circ$). This formula does not overestimate the strength of these joints with large D/T ratios, but it again is too conservative for a majority of K-joints with intersecting braces.

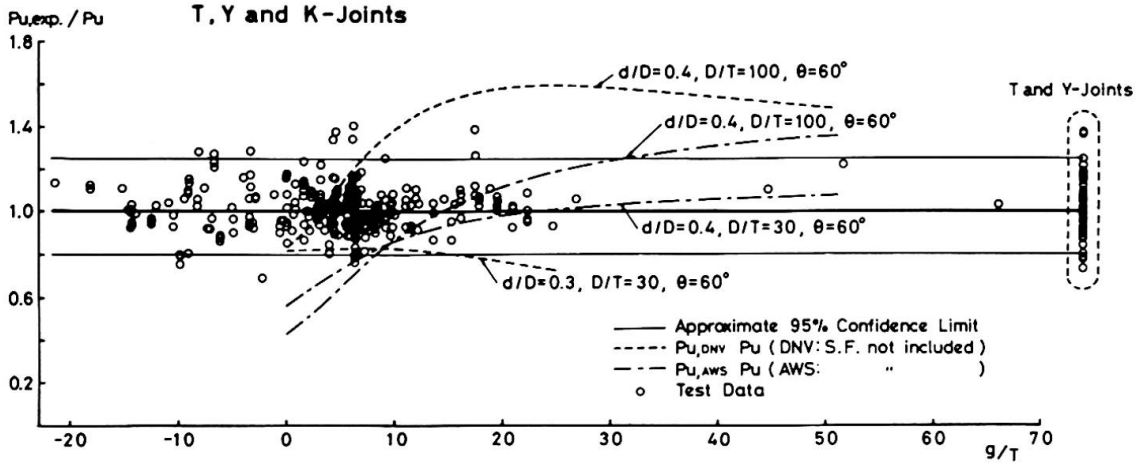

Fig. 6 Comparisons between Formula c, AWS and DNV Formulae and Test Data

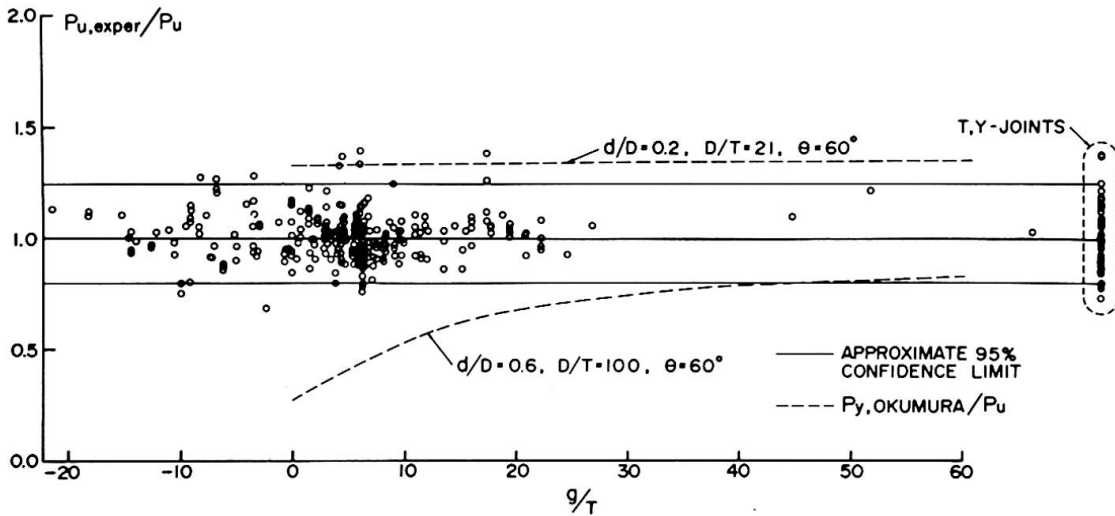
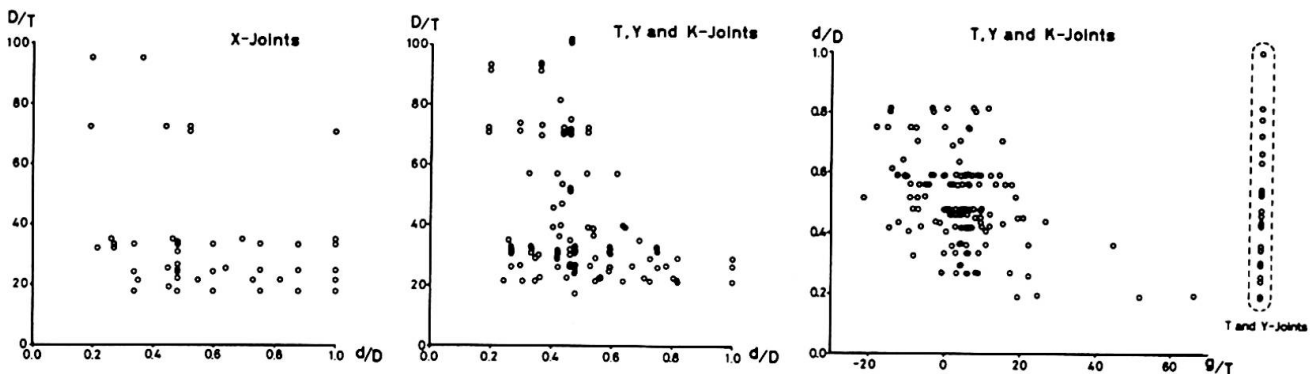

Fig. 7 Formula by Okumura et al Compared with Test Results (T, Y and K-Joints)



(from left) Figs. 8, 9, 10 Independent Variables in Test Data

6. CONCLUSIONS

The ultimate strength formulae summarized in Table 1 is applicable to the tubular X, T, Y and K-joints with a wide range of variation of each of the geometrical parameters. The formula c in the table can also applies to the K-joints with overlapping braces, which may be the first of such examples.

The test data, however, are still unavailable for some important ranges of variation of predicting variables. Examples of the areas that require further studies are:

1. The joints with a very heavy chord ($D/T < 20$) and with a very light chord ($D/T > 100$). The joints in these two extremities are often used in Jack-up and semi-submersible type offshore rigs, respectively.
2. The K-joint with large braces ($d/D \approx 1$).
3. Resistance of the joints under bending at the brace ends. It is to be noted that in the regression analyses an effect of secondary bending moments on the strength of the K-joint was treated merely as a factor that induces random errors.
4. The joints in high strength steels. The effects of material properties and heat treatments are still unaccountable factors that require additional work. Most of the test results were obtained through the joints made of cold formed tubes in mild steels or in low alloy medium strength steels.

REFERENCES

1. Y. Kurobane et al, "Ultimate Strength Formulae for Simple Tubular Joints," IIW Doc. XV-385-76 (May 1976)
2. Y. Kurobane, "Welded Truss Joints of Tubular Structural Members," Memoirs, Faculty of Engrg., Kumamoto Univ., Vol. XII, No. 2 (Dec. 1964)
3. K. Wasio et al, "Experimental Study on Local Failure of Chords in Tubular Truss Joints (I) and (II)," Technology Report, Osaka Univ., Vol. 18, No. 850 and Vol. 19, No. 874 (1968 and 1969)
4. N. R. Draper et al, "Applied Regression Analysis," John Wiley & Sons (1966)
5. AWS-Structural Welding Code, Sect. 10, AWS D1.1-72 (1972)
6. DNV, "Rules for the Design, Construction and Inspection of Fixed Offshore Structures," Det Norske Veritas (1974)
7. Okumura et al, "Estimation of Strength of Tubular Joints." Preliminary Report, 10th Congress of IABSE, Tokyo (Sept. 1976)

SUMMARY

This report presents the design formulae for the tubular X, T, Y and K-joints under static loads. It also discusses about the experimental grounds on which the formulae are based. The proposed formulae are compared with various existing formulae.

RESUME

Ce rapport présente les formules du calcul pour les noeuds de profilés circulaires, en forme de X, T, Y et K sous l'influence des charges statiques. Il présente aussi les bases expérimentales qui ont permis l'établissement de ces formules. Les formules proposées sont comparées avec d'autres formules existantes.

ZUSAMMENFASSUNG

Dieser Bericht enthält Bemessungsformeln für X, T, Y und K-Knoten von Hohlprofilen, unter statischen Belastungen. Die den Formeln zugrundeliegenden experimentellen Daten werden angegeben. Die Formeln werden schliesslich mit verschiedenen bereits bekannten Formeln verglichen.

IVa

Méthode de calcul à la fatigue

Methode zur Bemessung auf Ermüdung

Fatigue Design Method

F. CIOLINA

Professeur, Chef du Département Etudes
Compagnie Française d'Entreprises Métalliques
Paris, France

1 - INTRODUCTION

Deux communications du rapport préliminaire faites par nos confrères japonais donnent des résultats très intéressants sur la tenue à la fatigue des assemblages tubulaires en milieu marin.

Les développements présentés concernent des études expérimentales sur des noeuds types.

Cette communication a pour but de montrer les problèmes particuliers posés pour le dimensionnement des structures off-shore par l'utilisation des éléments précédents, à la fois sur le plan de la note de calcul et sur le plan pratique de la conception de la charpente.

2 - METHODES DE CALCUL

Le principe de l'étude à la fatigue consiste à déterminer les variations σ de contraintes élastiques en un point donné pour différents états de mer classés suivant la hauteur H des vagues mesurées de crête à creux. Il est possible de déterminer la fonction :

$$\sigma = f(N) \quad N \text{ nombre de cycles}$$

En divisant les contraintes en q classes, de valeur moyenne σ_i , le critère de PALM GREEN MINER s'écrit :

$$\sum_{i=1}^q \frac{n_i}{N_i} \leq 1$$

N_i correspondant au nombre de cycles maximum que peut supporter la structure pour des variations σ_i de contraintes.

L'utilisation du critère décrit ci-dessus pose quelques problèmes d'application pratique que nous détaillons.

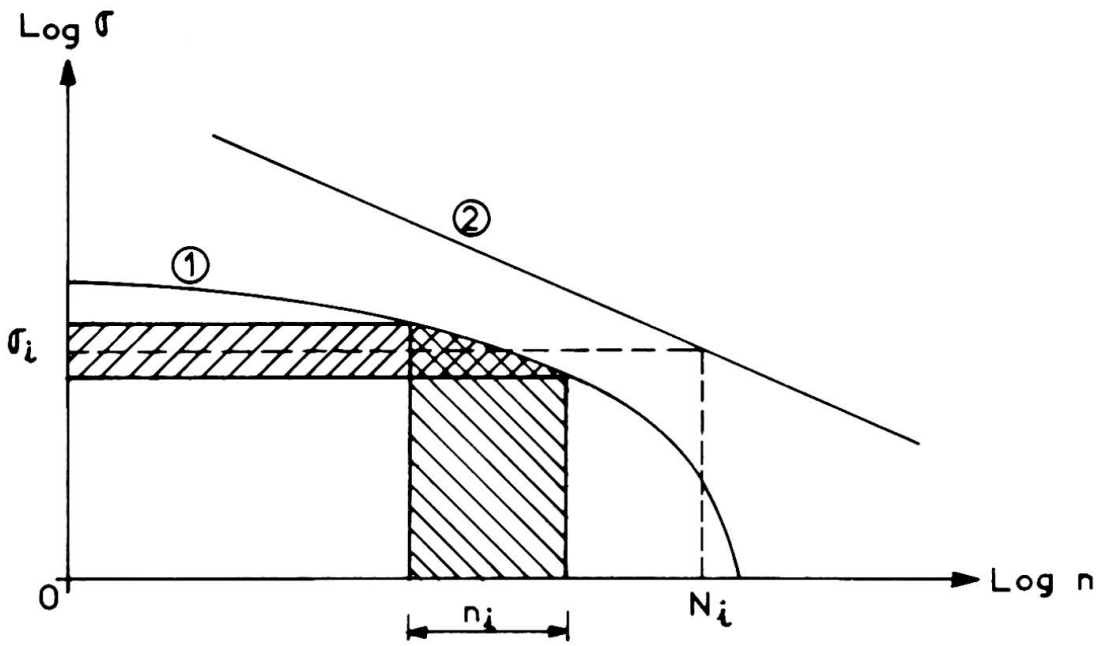

- ① Distribution des variations de contraintes
- ② Courbe de fatigue

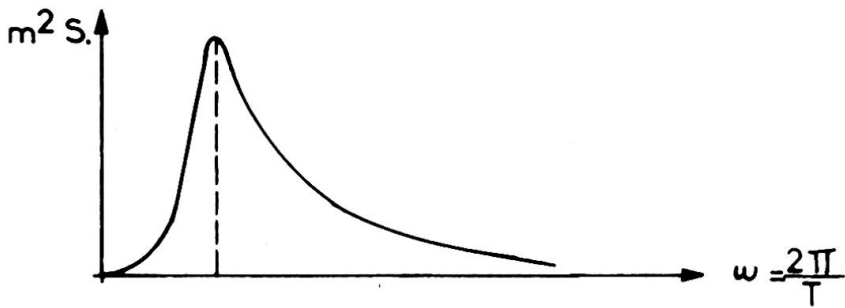

Spectre d'énergie (S)

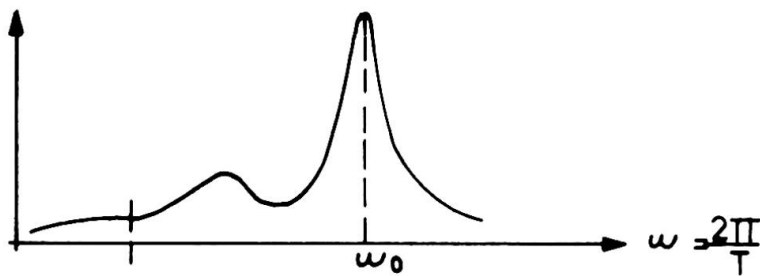

Fonction transfert (F)

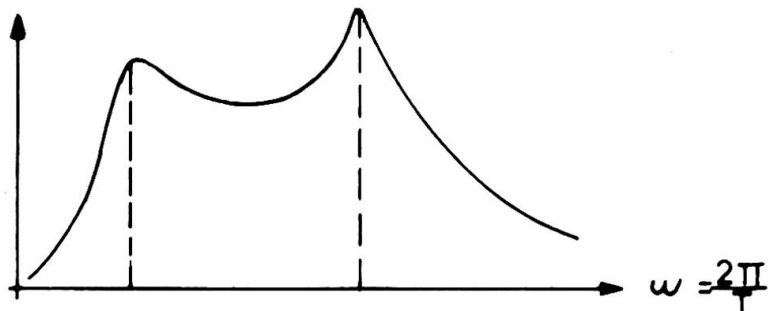

Spectre de réponse (S_r)

2.1 - Parmi les classes de vagues, celles correspondant aux hauteurs les plus faibles (1 à 3 mètres) contribuent pour une part très importante au dommage. En effet, la contrainte dynamique qui en résulte est très importante par rapport à l'effort statique. Ce phénomène résulte de la période qui est en général voisine du mode propre de vibration de la structure. Une telle analyse conduit à une estimation trop pessimiste du dommage.

Pour remédier à cette difficulté on peut faire une analyse spectrale des hauteurs de vagues (utilisation de spectres comme ceux de JONSAP ou de PIERSON MOSKOWITZ).

L'étude du comportement dynamique de la structure pour une direction de vague donne une fonction transfert F.

On obtient le spectre de réponse au niveau des contraintes grâce à l'équation :

$$(S_r) = (F^2) S$$

A chaque spectre S_i on peut associer la valeur :

$$m_{o_i} \text{ moyenne} = \int_0^{+\infty} S_r(\omega) d\omega \text{ et la probabilité } P_i$$

de dépassement de σ est égale à : $P_i = \exp. \left(- \frac{\sigma^2}{m_{o_i}} \right)$

Il en résulte que si l'on tient compte de tous les spectres, chacun ayant une probabilité P_i , on arrive à :

$$P = \sum_i P_i P_i$$

Cette fonction permet la détermination de $\sigma = f(N)$

Une telle démarche conduit à une évaluation plus optimiste (dommage cumulé de 30 % inférieur environ).

L'effet dynamique d'amplification diminue dans la mesure où les pointes du spectre et de la fonction transfert sont très éloignées.

2.2 - Un autre problème est celui de l'analyse des différentes phases de la vie de la structure. Celle-ci peut être remorquée (voir figure 1) puis basculée et mise en position.

Deux dommages peuvent être évalués :

- celui en cours de remorquage, lié à la route maritime choisie et à l'époque de l'année (été ou hiver)
- celui pendant la vie de l'ouvrage

Le cumul de ces deux valeurs est très discutable car les schémas hydrostatiques d'étude sont très différents. Actuellement, il n'existe pas de théorie valable sur l'accumulation des dommages dans des conditions très variables de temps.

Heureusement, les zones affectées par les efforts maxima sont très différentes suivant les périodes considérées. Dans un "Jacket" (figure 2), les efforts en cours de basculement dépendent en grande partie des zones ballastables et affectent peu les parties hautes et basses, très sensibles en phase définitive.



Figure 1 - Colonne articulée
en cours de remorquage

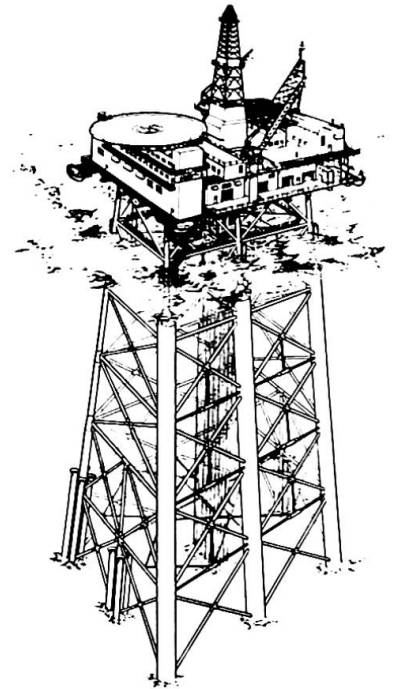

Figure 2 - Plateforme BRENT A

3 - MODIFICATIONS PERMETTANT DE REDUIRE LES DOMMAGES DUS A LA FATIGUE

Les calculs de fatigue nécessitent une bonne connaissance des conditions météorologiques et de la structure. Une telle coïncidence ne se produit qu'en fin de chantier d'assemblage. Il est donc utile de procéder à des modifications ne mettant pas en cause l'ensemble de la construction sous peine de retards inadmissibles.

Ces modifications possibles sont d'ordre très différent :

3.1 - Les efforts en cours de remorquage proviennent d'une statistique de houle liée à la période pendant laquelle se fait l'opération et au choix de l'itinéraire.

Il est possible de réduire le dommage en étudiant des itinéraires longeant les côtes avec des abris préalablement aménagés (coffres d'amarrage et signalisation, préinstallés). Un risque important réside dans les prévisions météorologiques à plus de 24 Heures en cas d'opération en pleine mer.

Une colonne articulée (voir figure 1) a pu être mise en place en Mer du nord, notamment sur le champ de BRENT grâce à une telle étude.

La position de remorquage peut constituer également un facteur important pour diminuer le dommage ; En restant dans le cas particulier des colonnes articulées, le basculement préalable en site abrité et un remorquage en position verticale, donnent une solution intéressante. Dans un tel cas, la colonne pilonne très peu même sous l'action de vagues de 3 à 4 m. Il est donc possible d'effectuer un remorquage pendant l'hiver en Mer du Nord.

Rappelons qu'une telle possibilité a été utilisée pour la mise en place de la colonne articulée sur le champ de FRIGG et pour celle installée sur le champ exploité par MOBIL.

L'étude des risques de fatigue est remplacée par une reconnaissance très soignée des hauts fonds sur l'itinéraire de remorquage.

3.2 - Les structures marines off-shore peuvent appartenir :

- soit à des ensembles composés de tubes (voir figure 3)
- soit à des ensembles composés de poutres en caisson (Pont de plate-forme fixe - voir figure 4)

Dans le premier cas, les risques de fissuration de fatigue sont concentrés dans les régions voisines des noeuds. Pour réduire les pointes de contraintes génératrices de fatigue, il est possible de mettre en place des diaphragmes internes lorsque le diamètre des pièces le permet. Ces diaphragmes doivent avoir des tracés très soignés pour obtenir une bonne égalisation des efforts.

L'étude peut être faite grâce à une modélisation convenable du noeud et à l'emploi d'un programme aux éléments finis. Les dissymétries du noeud et des barres adjacentes ainsi que les cas de charges à envisager, limitent les analyses. Bien souvent, les diagrammes obtenus permettent des conclusions qualitatives et non quantitatives.

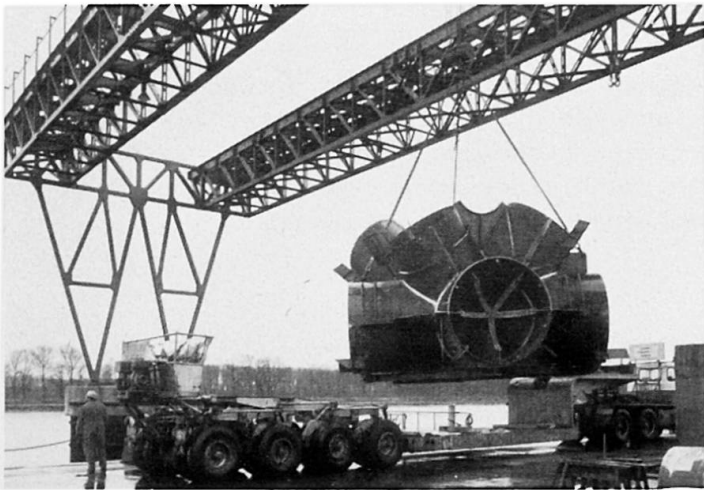

figure 3 - Noeud de plate-forme Penta 87

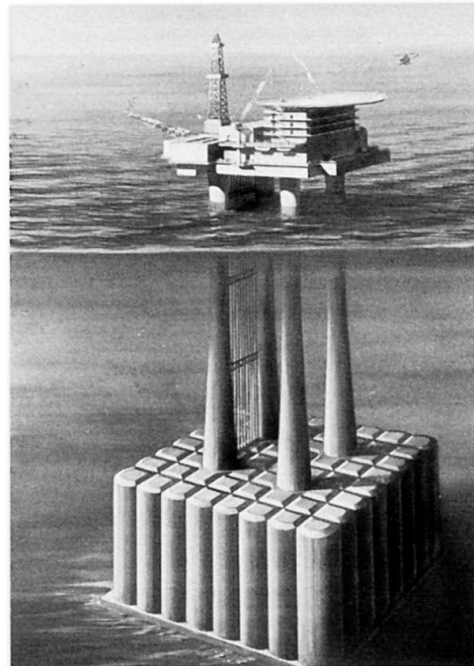

figure 4 - Cormorant
Pont en acier

Pour des barres de petit diamètre ($\emptyset < 1$ mètre), les aménagements sont très limités si le noeud est complètement réalisé. Dans le cas où les barres composées de tubes sont libres aux extrémités, on peut limiter les risques d'arrachement grâce à des recouvrements (over lapping). Sinon, la solution "gousset" ou "anneau de renfort" peut réduire légèrement les efforts longitudinaux, mais n'apportent pas de réduction à la contrainte d'arrachement (hot spot stress).

Dans le deuxième cas (poutres caissons), les efforts de fatigue sont sensibles au droit des ouvertures (diaphragmes ou passages de canalisation au droit des âmes de caissons). Celles-ci sont à border par des goussets suffisants.

La complexité des efforts transmis, nécessite une étude très poussée en éléments finis et il convient d'éviter des sections horizontales de tôles trop sollicitées dans les calculs de prédimensionnement. Enfin, les efforts dynamiques dus à la houle peuvent entraîner des renforts localisés sous les supports des modules.

RESUME

Le comportement en fatigue des structures marines nécessite une étude difficile qui doit tenir compte des spectres de houle et du comportement dynamique du système. Les risques de dommage à prendre en compte en service ou en phase de remorquage peuvent être diminués grâce à un certain nombre de dispositions constructives ou d'aménagements des itinéraires de remorquage.

ZUSAMMENFASSUNG

Das Ermüdungsverhalten von Bauwerken im Meer erfordert aufwendige Untersuchungen, welche das Wellenspektrum und das dynamische Verhalten des Systems berücksichtigen müssen. Die in Betracht zu ziehenden Risiken einer Beschädigung im Betrieb und beim Abschleppen können dank einer Anzahl von baulichen Massnahmen oder durch sachgemässe Auswahl der Schleppwege vermindert werden.

SUMMARY

Fatigue behaviour of off-shore constructions requires complex investigations which must allow for both swell spectra and overall dynamic behaviour. The damage risks to be reckoned with under service conditions and during towing can be reduced by resorting to a number of engineering solutions or by determining suitable tow routes.

IVa

A new Kind of Hybrid Construction

Une construction hybride nouvelle

Eine neue hybride Konstruktion

FRODE JOHAN HANSEN

M.Sc., F.I.C.E., Consultant

Per Hall Consultants Ltd., Hong Kong

Hong Kong

1. Introduction

In the earlier stages of the development of deep water oil production platforms for the North Sea the choice was oversimplified to one of using a pile supported steel jacket or a concrete gravity structure. Recent designs have combined both materials and are often referred to as "hybrids". (Fig. 1). In this paper the arguments for a new type of hybrid are explored and the resulting design (Tricon) briefly described. (Fig. 2).

2. The Problems and Some Solutions

An offshore platform structure in deep and exposed waters is a special case of a tall building with almost its entire payload concentrated in the "penthouse", subject to exceptionally large horizontal loadings of a cyclic nature and with uniquely difficult site access and foundation conditions. However, having accepted these rather special design and construction parameters, the design of such a structure should still be tackled and ultimately make as much sense as that of any other structure. In other words, the design concept should be governed by the "payload" and the permanent working conditions, be reasonably easy to construct and in the process possibly permitting some temporary overstressing.

The present generation of self-floating "jacket" structures does make sense in that respect, albeit with some obvious shortcomings.

The tubular joints, the node points, have become so large that the secondary stresses have reached a magnitude of prime importance, requiring a great amount of internal stiffening. They are however still not large enough to permit more than one or two welders to work inside the joint. Furthermore, the number of node points in a major structure is still so large that the prefabrication of these node points is a very critical element in the construction programme.

A tubular space frame with a minimum number of members and hence node points leads to a much more satisfactory structural concept. The tubular members become so big that they achieve a natural buoyancy even if made of reinforced or prestressed concrete, and the node point become so spacious, that a considerable work force can get inside them. They also become so accessible, that the internal stiffening members can be designed and positioned so correctly that secondary stresses can be reduced to what they ought to be; i.e. of secondary importance.

Another serious shortcoming of the larger pile supported jacket structures is the great proportion of weather and crane barge dependant offshore work. This proportion will ultimately, with increasing water depths and wave heights and narrowing weather windows, reach a "point of no return", and in the North Sea it lead to the introduction of the "gravity" structures.

The present generation of concrete, steel or hybrid gravity structures has solved the offshore installation problem by avoiding it - but at a very heavy premium. For their construction they require very special facilities - such as extremely deep and sheltered water - and their design leave no room for the designer to produce an optimum solution to the prime purpose of the structure; i.e. to support the payload safely and economically above the waves. It is a fact, that the optimum solution for the permanent conditions is incompatible with the temporary conditions, and that the structure is governed by the requirements for floating stability and structural strength during the towing and sinking operation. Having met these temporary conditions as well as those imposed by the restrictions of the available construction site, the designer is then left with the rather unsatisfying task of just checking, whether the structure is adequate for the permanent conditions. Hardly the way to produce the most economic structure, and at times, when the upper soil strata of the seabed are too weak, not even a way to produce just an acceptable structure.

It is in the approach to the foundation problem that both types of existing offshore structures show their worst limitations.

The pile supported structures suffer not only because the piles are difficult and costly to drive, but also because they are not the best and most economic foundation method. Loads of the same order of magnitude are often supported under water; bridge piers in connection with river or harbour crossings. In such cases one would generally dig down to a suitable foundation level and one would never contemplate driving piles to carrying capacities of several thousand tons a piece.

Similarly the gravity structures suffer not only because they become disproportionately large and impose high stresses on the upper and weaker soil strata, but also because they impose an impossible tas

on the designers. It is impossible to tailor make a foundation to suit an unprepared and practically unknown seabed or to determine the right length and strength of a penetrating skirt without exact information on the soil into which the skirt has to penetrate. Still, this is the very first design decision, which has to be made.

From the above considerations it would appear, that deep footings (assuming it is feasible to install them) are cheaper than long steel piles and also a more rational foundation method than resting directly on top of the seabed.

They are independent of the seabed topography and they eliminate the risk of sliding and the risk associated with scour of the seabed. They can furthermore be designed properly, taking full account of the prevailing soil properties, if the construction of the footings can be reversed to become the last item and not the first on the construction programme.

3. The Design

The above design considerations have resulted in the Tricon concept. Tricon consists of three basic elements; (i) on the top a short legged jack-up platform designed to the clients requirements, (ii) a main three legged space frame optimised to carry the payload and resist wave action, made up of large tubular members with few node points, and (iii) caisson footings sunk to a firm foundation.

The tubular space frame is constructed horizontally as a normal jacket structure. All the tubular members have considerable natural buoyancy and the structure as a whole floats in a very shallow water. The footings are circular hollow cylinders suitably stiffened to be able to spread the column load over the required foundation area. They can be made of steel, but even made of concrete will they possess enough buoyancy to float in shallow water.

Since the structure is being constructed horizontally, (Fig. 3) the footings can be added as the last item on the programme, and even with the diameter fixed the height can be increased until the last minute.

The structure is obviously extremely stable floating horizontally, but because of the positive buoyancy of all the tubular members it remains stable during all phases of the upending process which is achieved by controlled flooding.

Having touched down with the three footings resting on top of the seabed the tops of the columns are well above the waters surface. The caissons are now sunk into the seabed by means of excavation inside the footings. The excavation process is a self-contained and

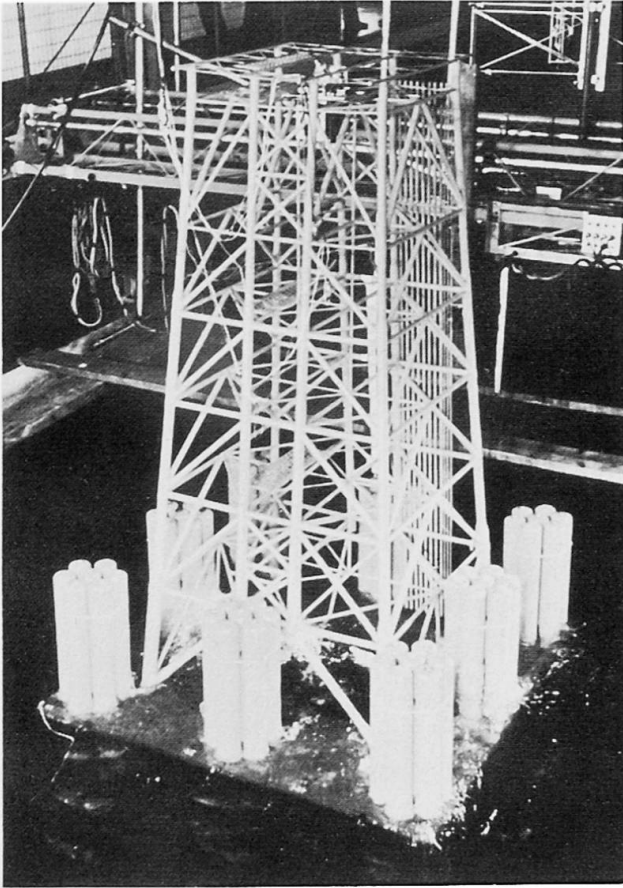

Fig. 1. RDL (NORTH SEA) HYBRID

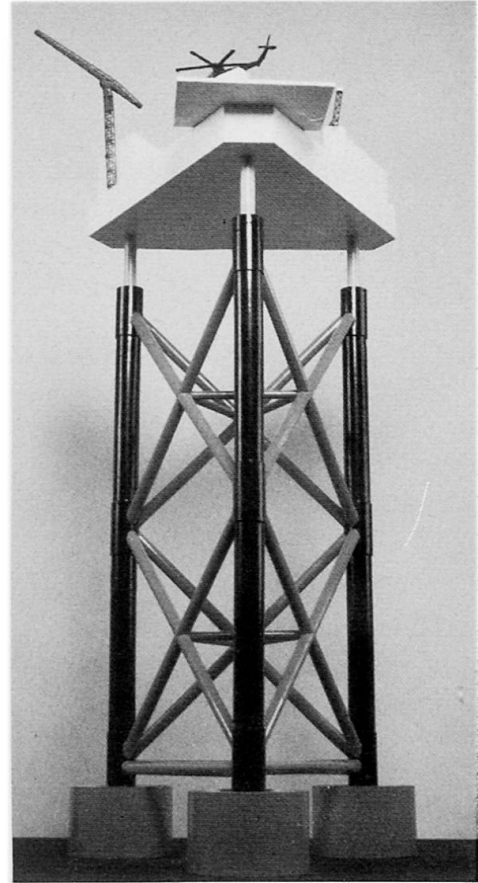

Fig 2. TRICON



Fig 3. TRICON IS FABRICATED & FLOATED HORIZONTALLY

practically weather independant operation. The necessary tools are built into the structure and there is plenty of room in the top of the columns to accommodate the working crew.

The excavation takes place under water with purpose made digging or tunnelling tools dragging the excavated material from the perimeter of the footings to the centre, where it can be removed by pumping or air lifting.

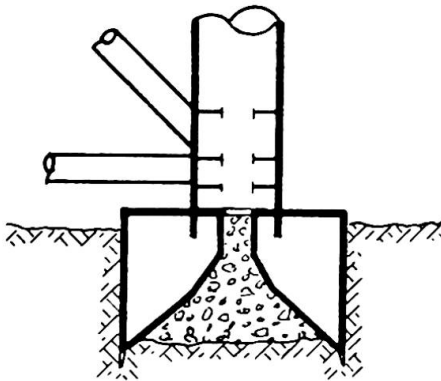

Caisson Foundation

As soon as the cutting edge of the footings has penetrated into the seabed and sealed off the interior of the footings from the outside water pressure, the structure gains instant "fixity" and it is possible to reduce the internal pressure and thus utilising the external hydrostatic pressure to assist the penetration into the seabed. In that respect the sinking of the Tricon feet is easier and more controllable than a caisson sinking in compressed air or even an open excavation for a bridge pier. Compared to the piledriving, where each hammer blow must exert a force of several thousand tons to achieve penetration, the excavation process is obviously much simpler, requiring a force of only a few tons to break down the soil into removable lumps and thus achieve penetration into the seabed.

The excavation process is continued until the tops of the columns are at a predetermined depth below the waters surface, access to the working space in the columns being gained through removable access shafts. With the footings at the right depth the space underneath the footings is backfilled with granular material and the Tricon foundation is completed.

The temporary access shafts are then removed and the underwater foundation is ready to receive the "jack-up" superstructure.

To land the "jack-up" legs on the Tricon columns requires a spell of calm weather, but only a very short spell, and no calmer than what is required to carry out one lift with a crane barge; i.e. equivalent to bringing one pile section into the pile guides or placing the hammer on top of one pile.

If required the whole process can be put in reverse for the removal and movement to a similar site. Excess hydraulic pressure can be utilised to force the raising of the caissons in a controlled manner.

If, as intended, the Tricon concept combines the structural economy of a "jacket" with the offshore installation economy of a gravity structure, it should logically lead to cheaper offshore structures.

SUMMARY

The new type of hybrid construction "TRICON" divides naturally into three distinct main sections:

the top - a conventional three-legged "jack-up" platform

the tower - a triangular tubular space frame with minimum number of members

the foundation - three deep caisson footings sunk into the seabed to a suitable foundation level.

It combines the best structural features of a "jacket" and the offshore installation advantages of "jack-ups" and "gravity" structures.

RESUME

La nouvelle construction hybride "TRICON" se divise en trois parties distinctes:

le sommet - une plate-forme conventionnelle à trois pieds sur vérin

la tour - un treillis tubulaire triangulaire avec un minimum de membrures

la fondation - trois profonds caissons de pied ancrés à un niveau de fondation convenable au fond de la mer.

Ceci combine les meilleures caractéristiques de chaque élément et les avantages d'une plate-forme auto-élevatrice et à embase.

ZUSAMMENFASSUNG

Die neue hybride Konstruktion "TRICON" lässt sich in drei Hauptabschnitte unterteilen:

oben befindet sich die übliche Plattform, die an drei Beinen auf und ab bewegt werden kann

der Turm ist eine fachwerkartige Rohrrahmenkonstruktion mit einem Minimum an Stäben

die Gründung erfolgt über drei Tiefcaissons, welche in den Seegrund bis zur tragfähigen Bodenschicht abgesenkt werden.

Damit werden gleichzeitig die Vorteile einer Hubinsel und einer Schwergewichts-Plattform realisiert.

IVa

Synthesis and Conclusions

Synthèse et conclusions

Synthese und Schlussfolgerungen

J.G. BOUWKAMP

President

Offshore Development Engineering, Inc.
Berkeley, California U.S.A.

Offshore Structures

Mr. Chairman, Ladies and Gentlemen,

We have just heard some additional highly interesting discussions on the subject of offshore structures which further emphasized the complexity of operating in offshore regions.

We would make a serious mistake if we would consider this field as an exclusively structural engineering territory. There is no question that the structural engineering input is of vital importance in developing an ultimately satisfactory structure. However, offshore engineering design requires the input of the oceanographer, who defines the sea state; the ocean engineer, who translates the ocean environment into hydrodynamic loads; the naval architect, who considers the stability and platform motions of both floating drilling and production systems and offshore towers during the towing and upending phases; the geotechnical engineer, who provides the necessary data to develop the foundation design; and the fabricator or contractor, who ultimately creates the system.

Each of these areas represents a challenge to the expert:

Variability and Environmental Influence on Wave Conditions

Most design wave spectra are based on open sea observations or at least, observations taken in areas of relatively open water. Since sea conditions can be strongly affected by bottom and shore topography, some attention should be given to ascertaining how such factors may modify wave conditions in a specific design condition, and to sensitivity studies which are aimed at finding the effect on a structure of anticipated variations about the design wave conditions.

Interaction of Wind Velocity Profile and Waves Impinging on a Structure

If a structure is exposed to storm waves of height similar to the dimensions of the above-water portion of the structure, the wind velocity profile and wind force acting on the structure vary with time. This wave influence on the design wind characteristics will

be superimposed on the natural gustiness of the storm wind environment and undoubtedly have an influence on both the mean and time dependent wind forces.

Correlation and Proper Simultaneous Treatment of Waves and Current

Important questions here involve the appropriate way of representing the combined flow field and the computation on bodies exposed simultaneously to waves and currents.

Hydrodynamic Loadings

Hydrodynamic loads, acting on the emerged structural members, are a result of the fluid motion associated with waves and current, and of the body motion induced in response to these forces, as well as earthquake and other external excitation. The combined structure-fluid motion effects are referred to by the terms "fluid-structure interaction" or "relative motion effects". The prediction of these fluid forces requires the solution of the complete fluid equations of motion (Navier-Stokes equations) with complicated boundary conditions, including the free surface, moving rigid boundaries of the structure, and the fixed boundaries, e.g. the ocean bottom. Complete solutions of this problem have been obtained in only a few elementary cases, and often substantial simplifications to the problem have been made. In the case of bodies whose dimensions are of the same order as the wave lengths, viscous forces are greatly exceeded by inertia forces, and may therefore be neglected in determining both the flow kinematics and the forces on the body. For bodies of small cross-section compared to the wave length, the pressure, velocity and acceleration field associated with wave motion is assumed unaffected by the presence of the body. The viscous drag forces and inertia or pressure forces are computed, using these kinematic quantities combined with empirical drag and inertia coefficients; the so-called Morrison formula. However, there is a range of body sizes in which both diffraction and viscous effects are important. It is in this area that a thorough understanding of the relative importance of these effects is essential. Furthermore, members which pierce the mean water surface are subjected to some other forces. These are the time-varying buoyancy and impact or slamming forces. The former is determined by geometric consideration, but the latter is not well understood at present. The wave impact force on above water structural members is similar to the slam force on a ship pitching in heavy seas or the impact of a seaplane when landing. However, it is necessary to recognize the differences between the phenomena which apply on the one hand in the case of a moving body contacting a moving wave surface, and on the other hand, a moving wave impinging on an essentially fixed body.

Wind Loading

Wind action on offshore platforms can contribute significantly to design loads. To evaluate the magnitude of wind loads, it is necessary to first predict the nature of the wind produced at the site, in terms of maximum mean wind velocity and the fluctuation of the wind velocity about this maximum mean value, i.e. gust characteristics, and second to transform these velocities into drag forces. This transformation is difficult to achieve realistically due to the very irregular geometry of the platform and its equipment. Conceptually, the wind force transfer function can be characterized as depending on the altitude and air density, time velocity direction characteristics

shape and effective area, motion response characteristics of platform, projected area, and variation of the force with velocity.

Ice Loadings

Ice loading on offshore platforms in the Arctic seas can be extremely severe. Ice islands and icebergs, which are of land origin, can easily destroy a platform. Fortunately this danger is limited since these are rare; therefore, no consideration of their effects is given in the design of offshore platforms. On the other hand, sea ice is frequently present and must be considered in the design. This ice, which forms in sheets, can be pushed into ridges, rafts, and hummocks, producing unconsolidated masses which later consolidate upon refreezing. The depth of this ice is highly variable, causing similar variations in the magnitude of force exerted on offshore platforms. This maximum force is limited by failure conditions at the edge of the ice mass; therefore, its magnitude depends on (1) the contact area, as determined by the thickness of the ice sheet and the maximum width of indentation caused by the structure during impact, (2) the aspect ratio of ice thickness to width of structure, (3) the shape of the structure, (4) the strength of the ice in unconfined compression, (5) the elastic properties of the ice, and (6) the conditions of ice as unfrozen or frozen, to the face of the structure.

Soil Loadings

Soil loadings can result from lateral and vertical loadings on foundation elements and develop rapidly, as a result of soil deformations in which the instantaneous and/or accumulative relative deformations are large. Such deformations could be developed from bottom soil movements induced by wave action, earthquakes and other similar flow slides or combination of the same. In addition, settlements, both laterally and vertically can occur during long periods, and may affect the foundation stability over the long time.

Earthquake Loadings

The earthquake loading is similar to the other principle loads acting on offshore structures in that the intensity of loading is influenced strongly by basic characteristics of the structure. However, in the case of the earthquake loading, the input forces depend on the mass and stiffness of the structure rather than on the exterior form, and by adjusting these parameters, particularly the stiffness, the designer can exert a great influence over the seismic loads a structure must resist. This fact is particularly significant in regard to the non-linear behavior of an offshore structure, because damages which occur in the structural system generally lead to reductions of stiffness which allow relaxation of the seismic input intensity. Thus, to a significant extent, earthquake damages tend to be self-limiting processes and the primary concern of the designer is to insure that the vertical load capacity of the structure is maintained as the earthquake damages occur.

Structural Modeling

With the loads defined, a mathematical model of the structural system must be established to permit the three-dimensional analysis of the internal forces and stresses. In the event of high overloads, such as produced by high magnitude earthquakes, this model must properly reflect the inelastic deformations produced. Further, in the

interest of providing a suitable working environment, motion of the deck must be predicted realistically. Only through refined and advanced analytical procedures and modeling techniques is it possible to accurately predict the structural response.

Foundation Modeling

To realistically model fixed platforms for three-dimensional analysis purposes, it is necessary that the foundation be properly modeled so that the structure-foundation and direction effects will be included in the results. As in the case of structural modeling, the techniques and methodologies used for this purpose vary considerably in practice. Basically there are three basic forms of foundation modeling for spread footings or mat foundations, namely: (1) constant discrete springs and dashpots for the soil foundation with the spring constants determined from elastic-static half-space theory and the dashpot coefficients having assigned values to represent material damping in the soil, (2) discrete springs and dashpots for the soil foundation with the spring constants and dashpot coefficients being frequency dependent in accordance with the elastic or viscoelastic dynamic half-space theory, and (3) finite element representations of a body of soil at the base of the structure. Foundation modeling for fixed towers supported on piles is most difficult to accomplish realistically. The techniques and methodologies used for this purpose range widely in practice, the simplest form being that of assuming full fixity for the piles at some specified effective depth in calculating lateral stiffness and assuming a distribution of the vertical load transfer from the pile to the soil in calculating vertical and rotational stiffnesses. For firm foundation conditions, the forces applied to the pile cap will be rapidly transferred to the soil with increasing depth into the foundation. In this case, pile cap impedance functions can be approximated using the impedance functions generated for a rigid massless circular disc supported on an elastic or viscoelastic half-space. For softer foundation conditions, the forces applied to the pile cap are transferred to the soil at deeper depths; thus, a more realistic representation of the load transfer from piles to soil is needed. This problem is a topic of basic research at the present time which should yield suitable pile foundation models in the near future.

Analysis Procedures

Dynamic analyses of linear fixed towers can be carried out in either the time domain or the frequency domain. Most analyses of this type, carried out in the past, have used the time domain approach. Recently, however, the frequency domain approach has become comparative through the development of Fast Fourier Transform techniques. If frequency dependent parameters are included in the overall fluid-structure-foundation system (e.g. frequency dependent hydrodynamic drag and inertia coefficients and/or frequency dependent foundation impedance functions), a time domain solution is not possible, but the frequency domain approach can be used without difficulty.

Performance Criteria

In addition to general loading methodologies and structural and foundation modeling techniques, other criteria related to the detailed structural response (e.g. fatigue, non-linear behavior, failure) are equally essential in the design process. Based on his experience

in fields other than offshore engineering, the structural engineer is particularly qualified to establish detailed prototype response criteria for both elements, connections and material properties. Furthermore, the overall design may not only be governed by the ultimate performance aspect, but also by the behavior of the structure during the different phases of construction, tow-out and installation. In the past, these latter phases have been considered as structurally less significant than the actual design phase. However, present offshore developments require structural systems for water depths of 800 to 1,000 feet or more. The remoteness of these regions may require tows covering several thousands of miles between assembly yard and installation site. Also, upending processes at the installation site necessitate a careful assessment of the dynamic response during this stage. It is now essential not only to consider the platform stability, but also the dynamic structural response during these tow-out and upending phases. This aspect becomes particularly significant if one considers the duration of these tows under potentially most adverse weather conditions and the often hostile prevailing sea state at the site. Damages during this phase, be it permanent or of fatigue nature, are factors which need full consideration in formulating the final design.

The previous comments emphasize that offshore structural design reflects the combined effort of many engineering disciplines. To achieve an optimum design for both stationary and floating structures in a mostly hostile, highly random and often insufficiently known environment, requires an integrated approach involving the most advanced technologies.

Leere Seite
Blank page
Page vide